

**MOUNTING PLATE ASSEMBLY**

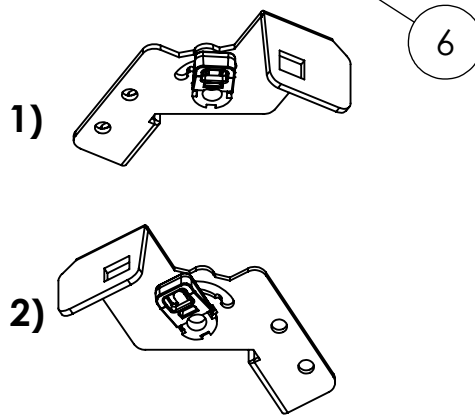
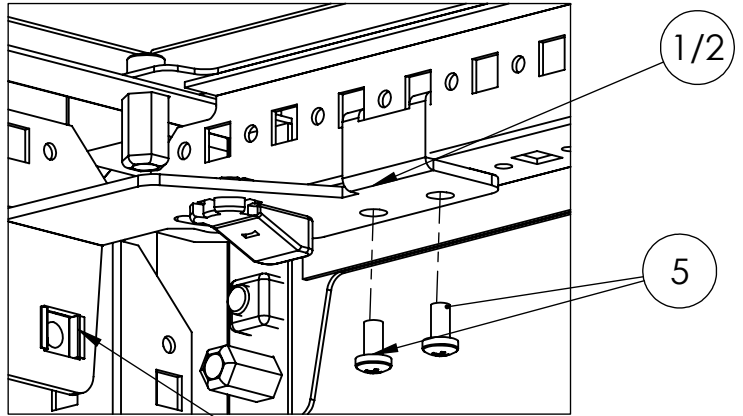
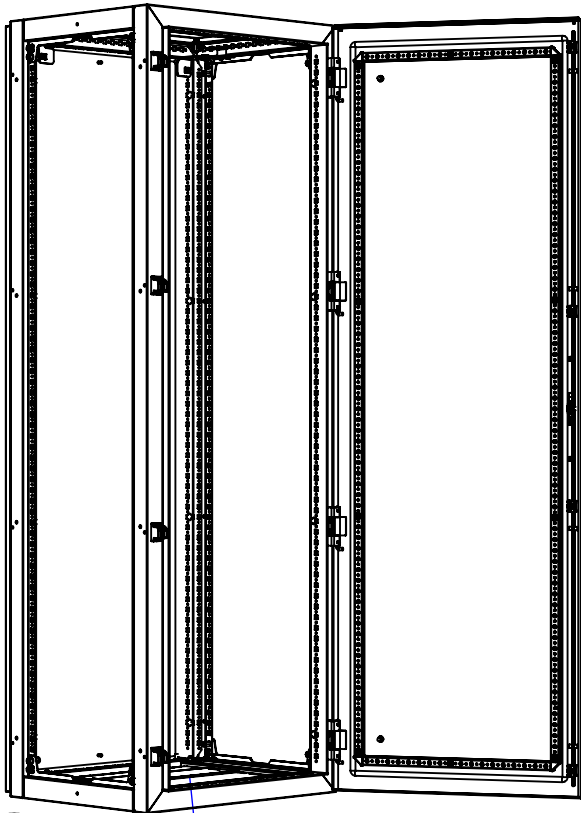

**M5x10**

**5)  x10**

**M8**

**6)  x2**

**7)  x2**

**3)  x1**

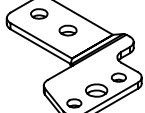
**4)  x1**

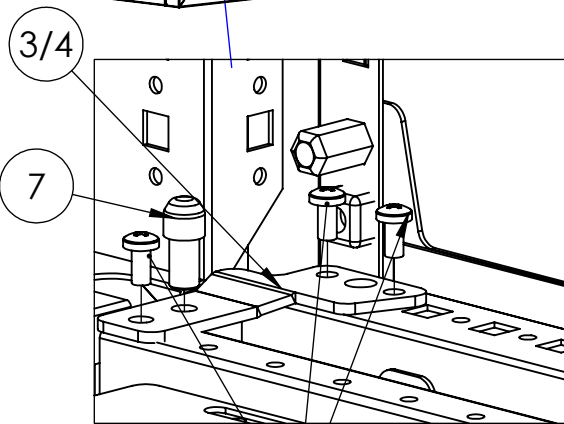

**5**

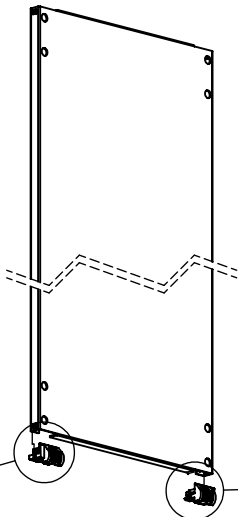

**LEFT**

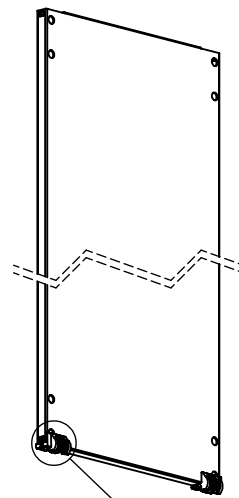

**RIGHT**

## MOUNTING PLATE ASSEMBLY

