

DATA SHEET: FILTERFAN IUKNF6523A / EXHAUST FILTER IUKNE550



SCHRACK-INFO

- Installation size 6, air flow rate up to 505 m³/h
- Three performance classes, cut-out compatible
- System of protection IP 54, NEMA type 12
- UL, cUL approval
- Cut-out compatible with installation size 6 from the 3rd Generation and with cooling unit DTFI 9021
- Standard: 230V AC / 50Hz

TECHNICAL DATA

Rated voltage ± 10%	AC 50 Hz / 60 Hz DC, 230 V
Unimpeded airflow	480 / 480 m³/h
Airflow rate in combination (IUKNF6523A + IUKNE650)	370 / 370 m³/h
Power consumption	65 / 80 W
Current consumption	0,3 / 0,36 A
Noise level acc. to EN ISO 3741	54 / 52 dB (A)
Weight	3,2 kg
Type of connection	spring-type terminal
Fuse	6 A
System of protection acc. to EN 60529 / UL 50	NEMA type 12 - standard filter
Filtration efficiency	91 %
Filter mat quality class acc. to DIN EN 779	G 4
Duty cycle	100 %
Bearing type	ball bearing
Service life L ₁₀ (+ 40 °C) ¹	40000 h
Temperature range	- 15 ... + 55 °C
Design (housing and protection against accidental contact)	made of injection-moulded thermoplastic, self-extinguishing, UL 94 VO
Colour	RAL 7035, different colours available on request

¹ Fan failure is defined as being when the current and speed deviate or the operating noises are out of the ordinary.

DIMENSIONS

mm	IUKNF6523A	IUKNE550
X	320	320
Y	320	320
Z1	7	7
Z2	150	39
A ¹	291	291
B ¹	291	291

¹ for material thicknesses up to 2 mm
+ 1 mm for thickness of material > 2 mm ≤ 3 mm

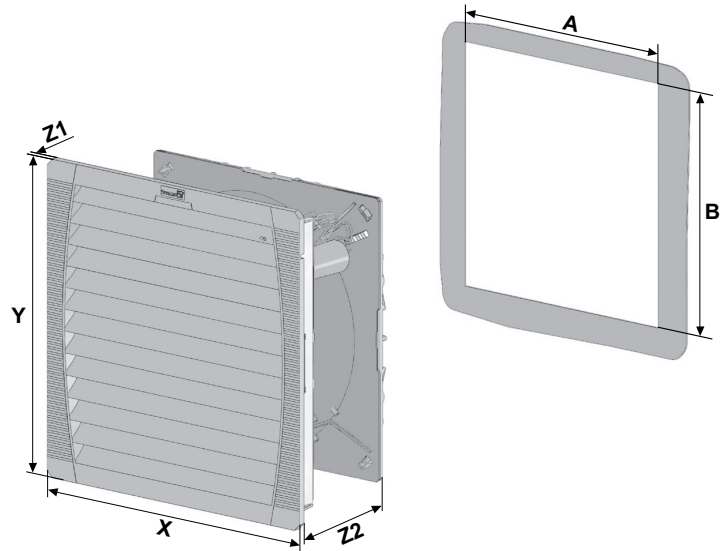

PERFORMANCE CURVES

COOLING CAPACITY PERFORMANCE CURVES

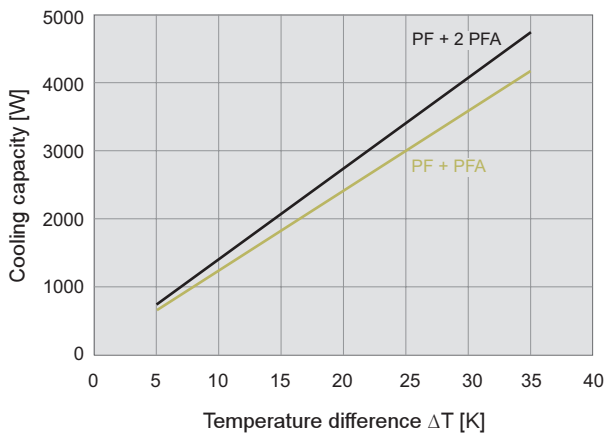

STATIC PRESSURE PERFORMANCE CURVES

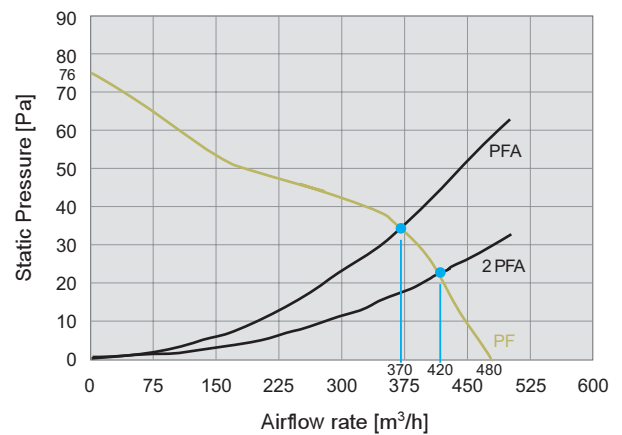

DESCRIPTION

Filterfan

ORDER NO.

IUKNF6523A

ACCESSORIES

Exhaust filter

IUKNE550