





















ideal lux[®]

IT EN FR DE ES RU

Indice generale

		Indice alfabetico	004
Moderno		Lampade a sospensione	010
		Lampade da soffitto	134
		Lampade da parete	190
		Lampade da tavolo	260
		Lampade da terra	290
Classico		Lampade a sospensione	320
		Lampade da soffitto	468
		Lampade da parete	486
		Lampade da tavolo	520
		Lampade da terra	544
Tecnico		Lampade a sospensione	560
		Sistemi lineari	578
		Tracklights	626
		Lampade da soffitto	660
		Lampade da parete	724
Esterno		Lampade da parete e soffitto	748
		Lampade da tavolo e terra	794
		Lampade a incasso	834
		Lampadine e accessori	844
		Indice per codice	864

Indice alfabetico

Abc	347	Audi-61	153	Boulder	535	Chalet	530	Culto	331
Accademy	413	Audi-61	197	Bow	240	Channel	708	Culto	470
Acqua	811	Audi-77	429	Box	229	Ciak	188	Culto	489
Admiral	149	Audi-80	46	Brandy	459	Ciak	257	Culto	522
Admiral	195	Audi-B	217	Breeze	368	Cico	244	Culto	547
Air	284	Augustus	433	Brick	735	Cima	760	Cupcake	288
Aladino	73	Aurora	40	Bright	739	Cima	805	Cylinder	80
Aladino	264	Aurora	194	Brigitta	399	Cin Cin	99	Cylinder	294
Alba	426	Avion	133	Brooklyn	357	Citrus	348	Daddy	300
Alba	476	Bar	61	Bubble	753	Clarissa	342	Daisy	157
Alexander	400	Barber	501	Ca' D'oro	403	Classic Globe	804	Danieli	398
Alfa	185	Barby	14	Ca' D'oro	506	Click	738	Danieli	505
Alfa	257	Baronet	401	Caesar	432	Clio	750	Dea	33
Alfiere	528	Base	776	Caesar	477	Clio	750	Dea	142
Ali	178	Basic	688	Caesar	510	Clio	750	Deca	463
Ali	216	Basket	122	Calypso	45	Clio	802	Deep	694
A-Line	51	Basket	206	Calypso	153	Clip	231	Delta	698
Alma	238	Basket	271	Calypso	197	Clown	20	Dema	813
Almond	156	Basket	295	Camelia	410	Club	577	Denis	233
Amaca	442	Beethoven	377	Camerino	234	Cocktail	69	Desiree	289
Amadeus	384	Bergen	349	Camilla	453	Cognac	60	Desk	576
Amelia	812	Beverly	497	Canapa	444	Colonna	306	Desk	740
Ampolla	344	Beverly	551	Candy	92	Colossal	378	Diamond	94
Amsterdam	526	Bijoux	478	Candy	161	Colossal	502	Disco	34
Amsterdam	550	Bin	522	Candy	265	Cometa	790	Dna	328
Andromeda	785	Bin	546	Cantina	356	Comfort	49	Doc	353
Anello	215	Birillo	286	Cantina	492	Commodore	220	Doge	397
Anfora	466	Birillo Out.	799	Carlton	424	Compo	78	Doge	504
Anna	761	Bistrò	362	Carlton	474	Compo	154	Dolomiti	534
Anna	805	Biva-50	552	Carlton	509	Cono	64	Don	85
Ape	517	Blanche	412	Carmen	516	Continental	382	Dony	178
Apollo	775	Blanche	507	Carrara	519	Copernico	324	Doris	796
Arca	580	Blob	334	Carta	105	Corallo	29	Dorothy	559
Arco	244	Blossom	82	Carta	269	Corallo	140	Dorsale	298
Aria	86	Blues	705	Casanova	396	Corallo	192	Double	245
Arizona	93	Boa	106	Cascina	456	Corda	445	Down	783
Arizona	160	Bob Mini	484	Ceci	839	Corte	457	Draft	616
Artù	453	Bob Mini	499	Cecilia	840	Corte	515	Dream Big	132
Astrid	500	Bollicine	22	Celine	174	Cortina	452	Driftwood	449
Astro	773	Bon Bon	408	Cerchio	285	Cosmo	23	Driftwood	532
Audi-10	47	Bon Bon	506	Cesto	350	Cover	729	Driftwood	553
Audi-20	82	Bonjour	239	Chalet	448	Cross	171	Dubai	431
Audi-61	48	Book	254	Chalet	513	Cube	736	Dubai	476

Dubai	■	510	Event	416
Duca		421	Eye	700
Duchessa		543	Fiesta	754
Dust		32	Fiocco	517
Dynamic		674	Fiordi	375
Dynamite	■	116	Firenze	■ 451
Dynamite	■	189	Firenze	■ 514
Dynamo		251	Firenze	■ 531
Edelweiss		354	Firenze	■ 555
Edgar		726	Fish	15
Edison	■	59	Fisherman	374
Edison	■	200	Fit	319
Edo		287	Fix	221
Edo Outdoor		820	Flam	61
Effetti		209	Flap	728
Ekos		120	Flash	232
Electric		341	Flash Gesso	742
Elegant	■	425	Flat	174
Elegant	■	474	Flex	251
Elica	■	202	Florian	■ 388
Elica	■	264	Florian	■ 503
Elica	■	292	Florian	■ 554
Elis	■	186	Fluo	606
Elis	■	258	Flut	70
Elisa		821	Focus	246
Elisir	■	422	Foglia	■ 455
Elisir	■	473	Foglia	■ 481
Elisir	■	508	Foglia	■ 514
Elisir	■	536	Foglio	743
Elvis		549	Foil	125
Eminent	■	277	Folk	371
Eminent	■	302	Forcola	559
Entry		460	Fox	644
Equinox	■	325	Frame	172
Equinox	■	488	Francy	787
Eris		360	Frida	■ 352
Esil		176	Frida	■ 492
Etere	■	764	Frida	■ 651
Etere	■	819	Funky	704
Eternity		529	Futura	■ 278
Etna		85	Futura	■ 310
Eva		83	Game	682
Evasione		429	Gas	■ 764



Ice

Pag 339

Indice alfabetico

Gas	808	Hilton	296	Kronplatz	530	Lucciola	245	Maximilian	407
Gea	211	Holiday	208	Kronplatz	551	Luce	96	Mercurio	823
Geko	179	Holly	19	Krypton	833	Luce Max	97	Mermaid	525
Gemma	179	Hotel	207	Kuky	65	Luce Max	266	Metro	368
Giada	39	Hugo	58	Kyoto	467	Lucia	792	Metro	652
Giada	143	Hydro	737	Lana	88	Lugano	355	Mib	791
Giada	193	Ice	339	Lana	163	Luna	753	Microphone	266
Giglio	451	Igor	338	Lana	202	Luna	798	Microphone	313
Giglio	513	Igor	491	Lawyer	527	Lunare	182	Mikado	171
Gim	255	Iguazù	62	Le Roy	538	Lunare	256	Mike	793
Gin	744	Iko	772	Le Roy	558	Lunare	648	Milk	68
Gingle	222	Impero	394	Lea	112	Luxor	427	Millennium	446
Gioconda	392	Inside	832	Leaves	28	Luxury	118	Minimal	57
Gioconda	504	Iris	175	Leaves	140	Luxury	205	Minimal	199
Giove	786	Isa	128	Led Panel	664	Luxury	270	Minimal	312
Giudecca	385	Isa	273	Lena	89	Luxury	293	Minitommy	766
Glim	646	Isa	297	Leti	838	Madame	121	Minitommy	830
Glim	706	It	58	Liberty	395	Maddi	793	Minor	25
Glim Compact	707	Itaca	801	Lido	72	Magic	540	Mint	361
Glory	91	Itaca	801	Lika	666	Maglie	466	Miramare	407
Glory	159	Jar	801	Lika	666	Magnolia	477	Mirror-10	242
Gocce	63	Jazz	704	Lilly	411	Majestic	425	Mirror-20	243
Goose	248	Justine	456	Limbo	495	Mallow	170	Mirror-51	243
Grape	329	Kalì	276	Line	235	Mallow	308	Mito	177
Gretel	364	Karma	84	Lingotto	337	Mama	87	Moby	373
Groove	696	Karol	173	Lingotto	471	Mandarin	359	Moby	653
Gru	282	Karousel	16	Link	654	Manhattan	67	Monet	447
Gun	757	Kate	541	Linus	618	Mapa	102	Mood	717
Gun	777	Kelly	280	Lite	250	Mapa	162	Moonlight	146
Halo	564	Ken	99	Live	800	Mapa	204	Moonlight	195
Halo	709	Keope	774	Logos	182	Mapa	268	Moris	227
Hammam	439	Kepler	326	Logos	225	Mapa Max	101	Mouse	648
Hammam	512	Kepler	489	Loko	333	Mapa Max	267	Mouse	720
Hangar	369	King	42	Lola	739	Mapa Plus	104	Mouse	732
Hansel	365	King	151	Lolita	277	Mapa Sat	100	Movie	188
Harem	438	Kiss	335	London	123	Maracas	485	Movie	314
Harem	479	Klaus	351	London	275	Maracas	488	Mr Jack	55
Harem	512	Klimt	318	London	305	Marte	822	Mr Jack	652
Haunt	443	Konse	35	Look	568	Martinez	423	Multiflex	131
Hellen	255	Kool	719	Look	650	Martinez	473	Multiflex	167
Hilton	127	Kool	737	Look	714	Martinez	508	Multiflex	213
Hilton	212	Kraken	548	Look	730	Matt	735	Nabucco	376
Hilton	272	Kronplatz	441	Lounge	704	Maurien	549	Napoleon	390

Navy	370	Opera	536
Nawa	440	Opera	554
Negresco	381	Oracle	562
Negresco	503	Oracle Slim	563
Nemo	110	Orangerie	464
Nemo Plus	109	Orbital	23
Neos	807	Origami	79
Neve	144	Orion	44
Neve	194	Orion	152
Neve	263	Orion	196
Newton	366	Ovalino	95
Newton	493	Ovalino	162
Newton	523	Ovalino	203
Newton	550	Oxy	594
Nitro	716	Page	249
Nodi	26	Pagoda	301
Nodi	136	Palio	452
Nodi	192	Pan	335
Nodi Crystal	139	Pan	490
Nodino	138	Pandora	86
Nordik	124	Pantheon	417
Nordik	206	Paris	437
Nordik	271	Paris	539
Nordik	294	Paris	556
Norma	461	Park	836
Norma	479	Park-Led	837
Norma	515	Pashà	428
Nostalgia	187	Pashà	475
Nostalgia	259	Pashà	509
Nova	662	Paul	214
Oak	575	Pauline	30
Oak	718	Pauline	141
Oby	183	Pearl	430
Oby	256	Pegaso	414
Ocean	175	Pegaso	507
Octopus	168	Pegaso	537
Oil	52	Pegaso	556
Olimpia	66	Penombra	107
O-Line	747	Penombra	204
Omega	768	Penombra	269
Onion	343	Peter	516
Opera	434	Petit	184
Opera	511	Phoenix	119



Linus

Pag 618

Indice alfabetico

Phoenix	■	163	Rain	■	292	Sesto		78	Stella		462	Tommy	■	831
Phoenix	■	205	Read		253	Shell		483	Steno		176	Tonic		745
Phoenix	■	293	Redentore		383	Sheraton	■	130	Step	■	537	Toronto		24
Piano		303	Regol	■	274	Sheraton	■	210	Step	■	557	Torre		818
Picchio		201	Regol	■	304	Sheraton	■	273	Stones		518	Totem		177
Pila		234	Renoir		405	Sheraton	■	297	Strauss	■	402	Tower		719
Pipeline		776	Retrò		496	Shots		115	Strauss	■	505	Toy		235
Pisa		450	Rex		788	Shower		494	Studio		283	Triade		367
Plumber	■	340	Rhapsody		17	Simply		181	Style	■	762	Tridente		316
Plumber	■	472	Rialto		403	Sirio		810	Style	■	809	Triplo		216
Plumber	■	491	Riflesso		727	Sky	■	570	Subway	■	114	Triumph	■	336
Polaris		811	Riga		108	Sky	■	650	Subway	■	236	Triumph	■	470
Polka		485	Ring		180	Sky	■	715	Subway	■	270	Triumph	■	490
Polly		309	Ritz		165	Sky	■	731	Subway	■	308	Tronco	■	763
Polo	■	567	Rocket		843	Slem	■	186	Sugar		77	Tronco	■	814
Polo	■	710	Rocket Mini		842	Slem	■	258	Sunglasses		758	Truman		524
Pon Pon		170	Roma	■	41	Slide	■	647	Sunrise		224	Tube		574
Pop		18	Roma	■	150	Slide	■	723	Swan	■	436	Tudor		214
Posta		230	Roma	■	196	Slot		620	Swan	■	511	Twin		784
Potty		460	Roma	■	263	Smarties	■	90	Swing		704	Ufo	■	566
Prato		287	Romantik		419	Smarties	■	158	Tall		50	Ufo	■	711
Privè		237	Rondo		465	Smarties	■	203	Tea		226	Ulisse	■	93
Probe		252	Rose		387	Smarties	■	265	Tek		233	Ulisse	■	160
Provence	■	420	Royal	■	147	Smile		636	Tender	■	169	Ultrathin		572
Provence	■	531	Royal	■	262	Snake	■	187	Tender	■	213	Umile		330
Provence	■	555	Rubens		223	Snake	■	259	Terra	■	765	Union		218
Pulsar		816	Rubik		779	Snell		533	Terra	■	829	Universal		712
Puzzle		215	Rudy	■	722	Snif		770	Terry		416	Up		778
Quadro		148	Rudy	■	734	Soda		745	Tesla		806	Up And Down		358
Quasar		36	Rustik		334	Soft		74	Tetris-1		780	Urano		756
Queen	■	437	Sailor	■	372	Sole	■	752	Tetris-2		781	Valentina	■	454
Queen	■	538	Sailor	■	493	Sole	■	797	Tick		219	Valentina	■	481
Queen	■	558	Sally		281	Soul		705	Tiepolo		386	Vanity		406
Quick		628	Saloon		350	Spark	■	327	Tintoretto		482	Vega		824
Radetzky		404	Samba Round		702	Spark	■	471	Tirol	■	454	Vela		220
Radio	■	56	Samba Square		703	Spiga		421	Tirol	■	480	Venus		817
Radio	■	198	Santa	■	380	Spot	■	648	Titano		825	Versus		37
Radio	■	311	Santa	■	502	Spot	■	721	Titti		166	Vinegar		54
Rail		113	Sasso		799	Spot	■	733	Tnt		351	Violette		418
Rain	■	38	Save		180	Stadium		565	Toffee		181	Virgin	■	43
Rain	■	143	Scacchi		518	Stage		315	Tokyo		24	Virgin	■	152
Rain	■	193	Sem		458	Stand Up		307	Tolomeo		81	Virus		747
Rain	■	262	Senix		419	Starlight		826	Tommy	■	767	Voga		542

Volt	346
Volterra	450
Vortex	■ 31
Vortex	■ 141
Walky	746
Wally	281
Wheel	■ 129
Wheel	■ 165
Whisky	744
White Lady	409
Windsor	409
Winery	■ 484
Winery	■ 498
Woody	■ 126
Woody	■ 164
Woody	■ 212
Woody	■ 272
Woody	■ 296
World	332
Xeno	759
Yoga	76
York	■ 276
York	■ 317
Zed	228
Zenith	828
Zeno	98
Zephyr	701
Zeus	782
Zig Zag	741
Zoom	117



Rhapsody

Pag 017

Moderno

Lampade a sospensione



Barby 014

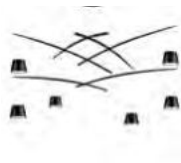

Fish 015



Karousel 016



Rhapsody 017



Pop 018



Holly 019



Clown 020



Toronto 024



Tokyo 024



Minor 025



Nodi 026



Leaves 028



Corallo 029



Pauline 030



Disco 034



Konse 035



Quasar 036



Versus 037



Rain 038



Giada 039

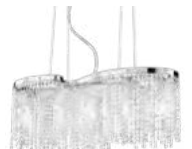

Aurora 040



Orion 044



Calypso 045



Audi-80 046



Audi-10 047



Audi-61 048



Comfort 049



Tall 050



Mr Jack 055



Radio 056



Minimal 057



Hugo 058



It 058



Edison 059



Cognac 060



Gocce 063



Cono 064



Kuky 065



Olimpia 066



Manhattan 067



Milk 068



Cocktail 069



Soft 074



Yoga 076



Sugar 077



Compo 078



Sesto 078



Origami 079



Cylinder 080



Eva 083



Karma 084



Etna 085



Don 085



Pandora 086



Aria 086



Mama 087



Bollicine 022



Cosmo 023

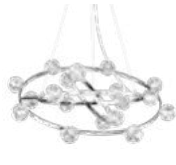

Orbital 023



Vortex 031



Dust 032



Dea 033



Roma 041



King 042



Virgin 043



A-Line 051



Oil 052



Vinegar 054



Flam 061



Bar 061



Iguazù 062



Flut 070



Lido 072



Aladino 073



Tolomeo 081



Blossom 082



Audi-20 082



Lana 088



Lena 089



Smarties 090



A-Line

Pag 051

Moderno

Lampade a sospensione



Glory 091



Candy 092



Ulisse 093



Arizona 093



Diamond 094



Ovalino 095



Luce 096



Cin Cin 099



Mapa Sat 100



Mapa Max 101



Mapa 102



Mapa Plus 104



Carta 105



Boa 106



Nemo 110



Lea 112



Rail 113



Subway 114



Shots 115



Dynamite 116



Zoom 117



Madame 121



Basket 122



London 123



Nordik 124



Foil 125



Woody 126



Hilton 127



Multiflex 131



Dream Big 132



Avion-1 133



Avion-2 133



Luce Max 097



Zeno 098



Ken 099



Penombra 107



Riga 108



Nemo Plus 109



Luxury 118



Phoenix 119



Ekos 120



Isa 128



Wheel 129

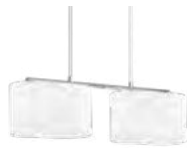

Sheraton 130



Carta

Pag 105



Barby

Base e montatura in metallo verniciato nero opaco. Schermo diffusore in materiale plastico opale. Led integrati.

LED Sorgente luminosa LED 4000 K, 20.000 h di durata.

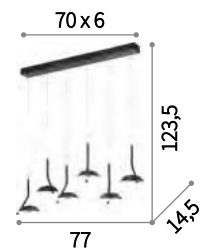

■ □ IP20

2,210 Kg / 0,0415 m³
LED 30W / 1950 Lm

190778 ■ € 335



196992



Fish

Rosone, asta e diffusore in metallo verniciato bianco o nero opaco. Cavo in acciaio con supporto in metallo cromato. Led integrato con schermo opale.

LED Sorgente luminosa LED 3000 K, 20.000 h di durata.



196961

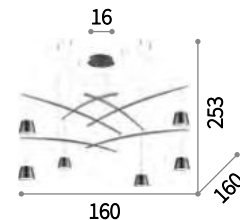

IP20

6,790 Kg / 0,0377 m³
LED 37W / 2800 Lm

196985 € 500
196992 € 500

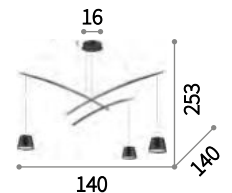

IP20

3,120 Kg / 0,0377 m³
LED 18W / 1400 Lm

196961 € 335
196978 € 335



Karousel

Montatura in metallo rifinito in ottone satinato. Diffusori in vetro incamiciato bianco, soffiato e acidato.

LED Lampadine LED G9 3,2W 3000 K incluse. Cod. 209043

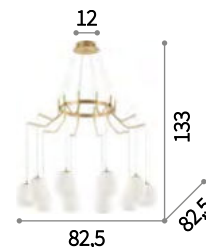

IP20
 4,340 Kg / 0,1739 m³
 G9 max 10 x 15W
 206394 ■ € 600

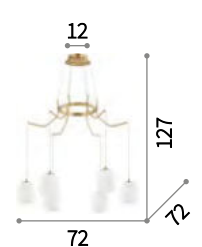

IP20
 2,810 Kg / 0,1055 m³
 G9 max 6 x 15W
 206387 ■ € 400

3000 K / 300 Lm
 209043 € 3,50

3000 K / 300 Lm
 209043 € 3,50



Rhapsody new

Montatura in metallo con rosone rifinito ottone satinato e bracci nero opaco. Cavi in pvc. Diffusori in vetro soffiato bianco acidato.

LED Lampadine LED G9 3,2W 3000 K include. Cod. 209043

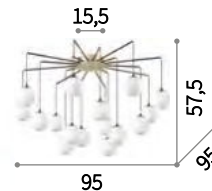

IP20 INCLUSA

5,020 Kg / 0,2040 m³
G9 max 16 x 28W

236964 ■ € 550 new

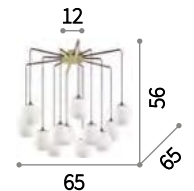

IP20 INCLUSA

3,510 Kg / 0,1399 m³
G9 max 12 x 28W

236957 ■ € 400 new

 3000 K / 300 Lm
209043 € 3,50

 3000 K / 300 Lm
209043 € 3,50



Pop

Rosone, montatura e copri portalampane in metallo rifinito con vernice opaca bianca o nera. Cavi regolabili in lunghezza.

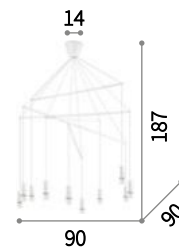
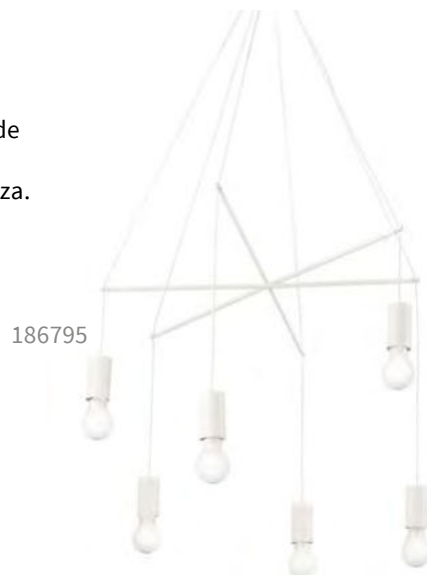

⏏ (⊕) IP20

2,920 Kg / 0,0147 m³
E27 max 10 x 60W

186801 ■ € 215
158860 ■ € 215

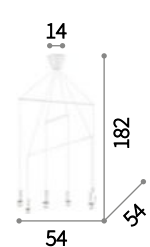

⏏ (⊕) IP20

1,670 Kg / 0,0096 m³
E27 max 6 x 60W

186795 ■ € 145
158815 ■ € 145

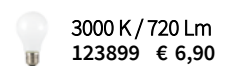
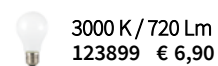



231594

Holly **new**

Rosone e diffusori in metallo con finitura ottone spazzolato o verniciato a polveri con finitura bianca o nera. Cavi rivestiti in tessuto.

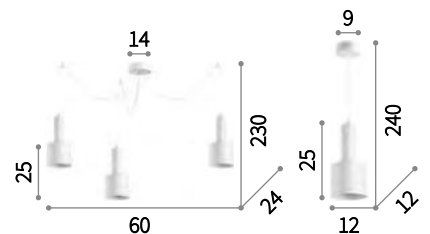

⏏ IP20

⏏ IP20

2,740 Kg / 0,0254 m³
E27 max 3 x 60W

0,780 Kg / 0,0064 m³
E27 max 1 x 60W

231587 € 130 **new**
231600 € 220 **new**
231594 € 130 **new**

231556 € 50 **new**
231570 € 80 **new**
231563 € 50 **new**

💡 3000 K / 720 Lm
123899 € 6,90

💡 3000 K / 720 Lm
123899 € 6,90



100883



100913

Clown

Montatura in metallo con diffusori in vetro soffiato e modellato a mano. Disponibile con montatura in cromo e vetri multicolor o cromati o con montatura e vetri bianchi.



Lampadine alogene G9 28W 2700 K incluse.

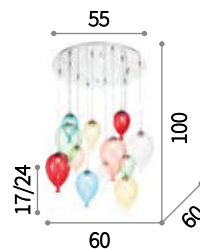

IP20
 6,000 Kg / 0,1860 m³
 G9 max 12 x 28W
 100951 € 557

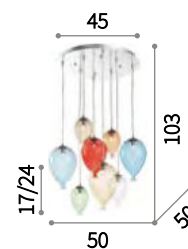

IP20
 5,700 Kg / 0,1442 m³
 G9 max 8 x 28W
 100883 € 345
 100913 € 390
 100944 € 390

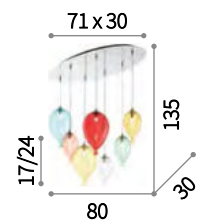

IP20
 5,000 Kg / 0,1283 m³
 G9 max 7 x 28W
 100937 € 365

3000 K / 300 Lm
 209043 € 3,50

3000 K / 300 Lm
 209043 € 3,50

3000 K / 300 Lm
 209043 € 3,50



100951



087924

Bollicine

Elementi decorativi con bolle di vetro soffiato. Disponibile con bolle trasparenti e bianche o trasparenti e cromo.

 Lampadine alogene G9 28W 2700 K incluse.



093024

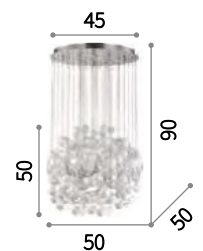

  IP20  INCLUSE

9,500 Kg / 0,2076 m³
G9 max 14x40W

087924  € 865
093024  € 935

 3000 K / 300 Lm
209043 € 3,50

Cosmo

Montatura in metallo con finitura in rame.
Elementi circolari rotanti posizionabili a piacere.

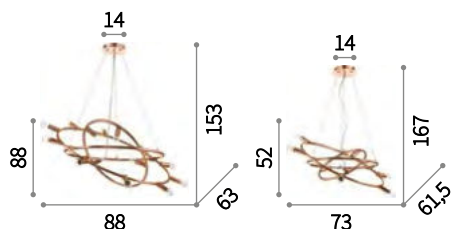

IP20

4,640 Kg / 0,1223 m³
E14 max 15 x 40W

133058 € 444

IP20

3,400 Kg / 0,0807 m³
E14 max 9 x 40W

133041 € 344

2200 K / 300 Lm
151656 € 4,50

2200 K / 300 Lm
151656 € 4,50



Orbital

Montatura in cromo composta da anelli
concentrici ruotabili. Diffusori a sfera
con decorazione interna in filamenti di vetro.
Cavi in acciaio a lunghezza regolabile.

Lampadine alogene G9 28W 2700 K
incluse.

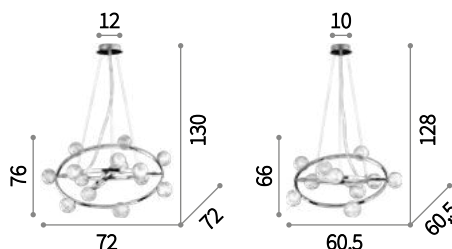

IP20

4,770 Kg / 0,0917 m³
G9 max 14 x 40W

073835 € 460

IP20

3,600 Kg / 0,3157 m³
G9 max 10 x 40W

073828 € 373

3000 K / 300 Lm
209043 € 3,50

3000 K / 300 Lm
209043 € 3,50



Toronto

Montatura in metallo cromato o verniciato bianco opaco. Cavi in acciaio regolabili. Lampadine led GX53 sostituibili.

LED Lampadine LED GX53 9,5W 3000 K include. Cod. 123936

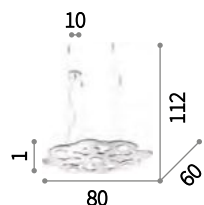

5,140 Kg / 0,0702 m³
GX53 max 5 x 15W

195285 € 530
197050 € 570

 3000 K / 760 Lm
123936 € 5,90



197050



195285

Tokyo

Montatura in metallo cromato regolabile in altezza. Diffusori in vetro soffiato bianco incamiciato e acidato.

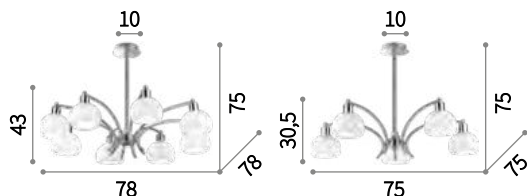

5,200 Kg / 0,1519 m³
E14 max 8 x 40W

068466 € 260



3,600 Kg / 0,1386 m³
E14 max 5 x 40W

068459 € 200

 3000 K / 360 Lm
101217 € 3,00

 3000 K / 360 Lm
101217 € 3,00









Minor new

Montatura e diffusori in metallo verniciato a polveri con finitura nera. Cavo elettrico in pvc.

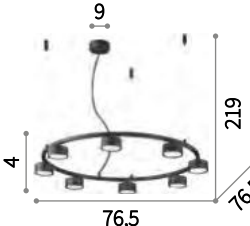
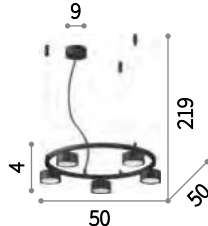
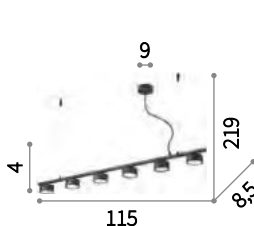
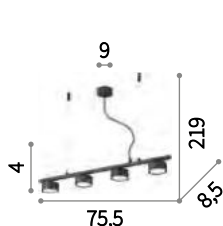
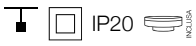
LED Lampadine LED GX53 7W 3000 K incluse. Cod. 101385



 <p>9 4 76,5 219 16,5</p>	 <p>9 4 50 219 50</p>	 <p>9 4 115 219 8,5</p>	 <p>9 4 75,5 219 8,5</p>
 <p>IP20 INCLUSA GX53</p>	 <p>IP20 INCLUSA GX53</p>	 <p>IP20 INCLUSA GX53</p>	 <p>IP20 INCLUSA GX53</p>
<p>3,440 Kg / 0,1199 m³ GX53 max 8 x 15W 235547 ■ € 350 new</p>	<p>2,250 Kg / 0,0564 m³ GX53 max 5 x 15W 235516 ■ € 250 new</p>	<p>2,210 Kg / 0,0203 m³ GX53 max 6 x 15W 235486 ■ € 250 new</p>	<p>1,650 Kg / 0,0135 m³ GX53 max 4 x 15W 235455 ■ € 200 new</p>

 3000 K / 560 Lm
101385 € 5,50

 3000 K / 560 Lm
101385 € 5,50

 3000 K / 560 Lm
101385 € 5,50

 3000 K / 560 Lm
101385 € 5,50



Nodi **new**

Montatura in metallo cromato oppure in ottone satinato. Elementi di giunzione ruotabili per una disposizione personalizzata. Diffusori in vetro bianco soffiato, acidato o trasparente e cromato.

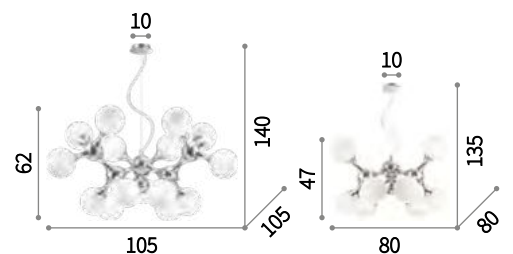

IP20

8,000 Kg / 0,4651 m³
E14 max 15 x 40W

082073 € 475
241012 € 475 **new**
200491 € 617

IP20

5,300 Kg / 0,1479 m³
E14 max 9 x 40W

082059 € 330
241036 € 330 **new**



P. 136



P. 192



3000 K / 430 Lm
101200 € 2,90



3000 K / 430 Lm
101200 € 2,90



082073





112268

Leaves

Montatura in metallo. Elementi decorativi in vetro soffiato e modellato a mano. Sospensioni con cavi d'acciaio regolabili in lunghezza. Disponibile con montatura in cromo e vetri fumé o con montatura e vetri bianchi.

 Lampadine alogene G9 28W 2700 K incluse.



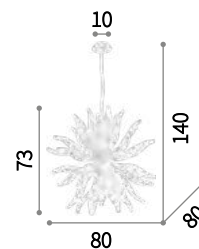

111940

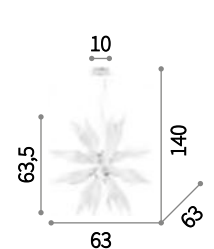

 IP20 
 5,800 Kg / 0,1123 m³
 G9 max 12 x 40W
 112268 € 700



 IP20 
 3,700 Kg / 0,0702 m³
 G9 max 8 x 40W
 111957 € 450
 111940 € 460



P. 140

 3000 K / 300 Lm
 209043 € 3,50

 3000 K / 300 Lm
 209043 € 3,50



Corallo

Montatura a sfera e dettagli in metallo cromato. Elementi decorativi in vetro bianco lavorato a mano.

 Lampadine alogene G9 28W 2700 K incluse.

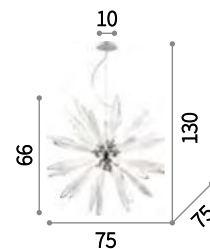

 IP20 
 7,680 Kg / 0,0496 m³
 G9 max 12 x 40W
 074689 € 572

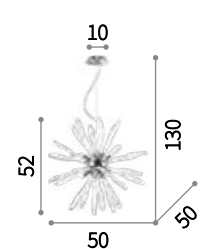

 IP20 
 3,600 Kg / 0,0389 m³
 G9 max 8 x 40W
 086576 € 455



P. 140 P. 192

 3000 K / 300 Lm
 209043 € 3,50

 3000 K / 300 Lm
 209043 € 3,50





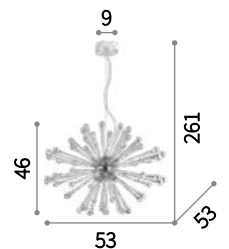

Pauline

Montatura in metallo cromato. Elementi decorativi in vetro soffiato e modellato a mano. Sospensioni con cavi d'acciaio regolabili in lunghezza.

LED Lampadine LED G9 3,2W 3000 K include. Cod. 209043





 IP20  INCLUSE
 6,300 Kg / 0,0596 m³
 G9 max 8 x 40W
 115801 € 522





101613



Vortex

Montatura in metallo verniciato bianco opaco. Elementi decorativi in metallo modellato artigianalmente e dipinti a mano con oro o argento.



101606

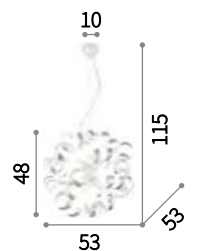

IP20

2,500 Kg / 0,2344 m³
E14 max 6 x 40W

101613 € 188
101606 € 188







Dust

Montatura in tubolare di alluminio argentato lavorato e modellato artigianalmente. Cavo elettrico regolabile in lunghezza.

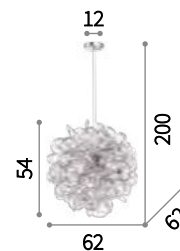
 Lampadine alogene G9 28W 2700 K incluse.



 IP20 
 2,280 Kg / 0,2421 m³
 G9 max 12 x 40W
 114361 ■ € 494

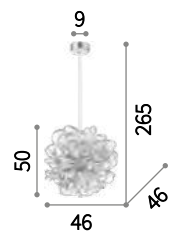

 IP20 
 1,450 Kg / 0,1152 m³
 G9 max 8 x 40W
 114811 ■ € 305

 3000 K / 300 Lm
 209043 ■ € 3,50

 3000 K / 300 Lm
 209043 ■ € 3,50



Dea

Montatura a sfera e copri portalampade in metallo cromato. Cavo in acciaio a lunghezza regolabile da dispositivo ferma cavo automatico.

LED Lampadine LED E27 2W Globo D125 trasparente 3000 K incluse.
Cod. 184470

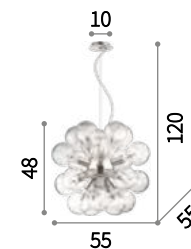

IP20
5,800 Kg / 0,1441 m³
E27 max 20 x 42W
074801 € 500

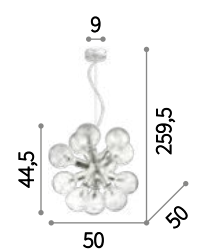

IP20
3,700 Kg / 0,1072 m³
E27 max 12 x 42W
074771 € 320



P. 142

3000 K / 860 Lm
101347 € 8,90

3000 K / 860 Lm
101347 € 8,90



Disco

Montatura con elementi decorativi circolari rotanti e posizionabili a piacere. Disponibile in metallo verniciato in bianco o nero opaco oppure in legno naturale sagomato.

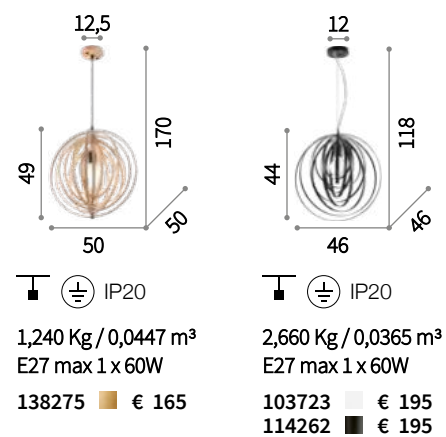
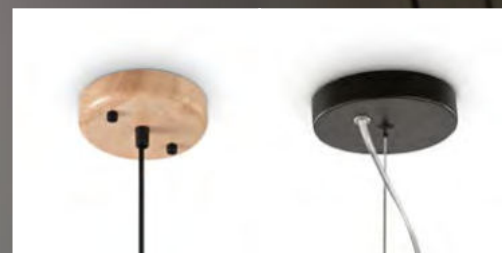

3000 K / 720 Lm
 101330 € 8,50

3000 K / 720 Lm
 101330 € 8,50



Konse

Montatura ed elementi decorativi interamente in metallo. Finitura con vernice oro scuro satinato.

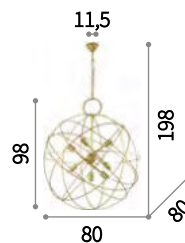

IP20

4,600 Kg / 0,7203 m³
E27 max 7 x 60W

156033 € 855

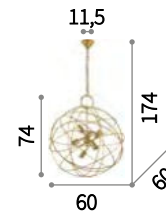

IP20

3,510 Kg / 0,1201 m³
E27 max 6 x 60W

156026 € 515

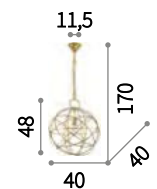

IP20

1,930 Kg / 0,1175 m³
E27 max 1 x 60W

155968 € 215

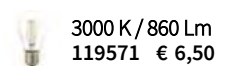
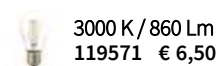
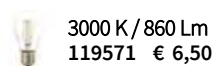



Quasar

Montatura in cromo. Vetri in canna di pirex sagomati a mano. Sospensioni con cavi in acciaio a lunghezza regolabile da dispositivi automatici.



Lampadine alogene G9 28W 2700 K incluse.

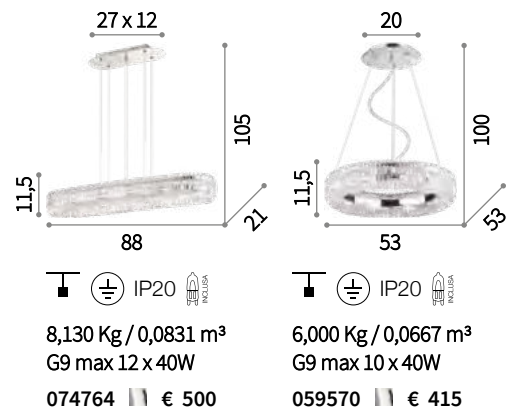

3000 K / 300 Lm
209043 € 3,50

3000 K / 300 Lm
209043 € 3,50



Versus

Montatura in metallo cromato. Elementi decorativi con catenine metalliche a maglia quadrata. Cavi in acciaio regolabili in altezza da dispositivi blocca cavo automatici.

LED Sorgente luminosa LED 3000 K, 30.000 h di durata.

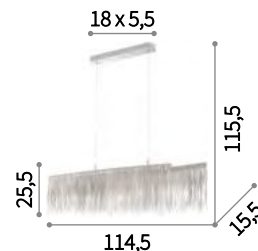

IP20

4,450 Kg / 0,0445 m³
LED 43,2W / 4300 Lm

137056 € 586

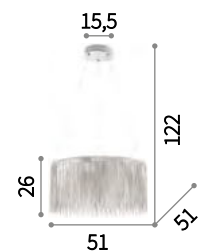

IP20

3,200 Kg / 0,0370 m³
LED 33,6W / 3300 Lm

137032 € 430



105277

Rain

Montatura in metallo cromato. Pendagli con elementi in cristallo colorato e molato in varie forme e gocce finali. Sospensioni con cavi in acciaio a lunghezza regolabile.



008363

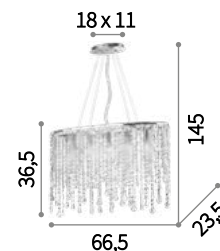

IP20

3,320 Kg / 0,0266 m³
E14 max 5 x 40W

008363 € 278
105277 € 324

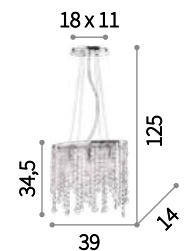

IP20

1,870 Kg / 0,0131 m³
E14 max 3 x 40W

008349 € 180



P. 143



P. 193



P. 262



P. 292



3000 K / 430 Lm
101224 € 2,90



3000 K / 430 Lm
101224 € 2,90



099170

Giada

Montatura in metallo cromato. Pendagli con elementi ottagonali e puntali finali in cristallo molato. Sospensioni con cavi in acciaio a lunghezza regolabile.

 Lampadine alogene G9 28W 2700 K incluse.



098722

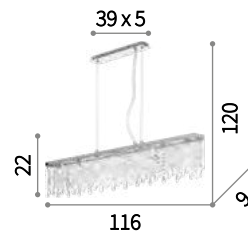

 IP20 

5,500 Kg / 0,0297 m³
G9 max 7 x 40W

098739 € 460
099170 € 485

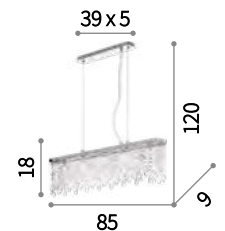

 IP20 

4,000 Kg / 0,0217 m³
G9 max 5 x 40W

098722 € 340



P. 143



P. 193

 3000 K / 300 Lm
209043 € 3,50

 3000 K / 300 Lm
209043 € 3,50



Aurora

Montatura in metallo cromato. Pendagli con elementi in cristallo molato ottagonali. Sospensioni con cavi in acciaio a lunghezza regolabile da dispositivi automatici.

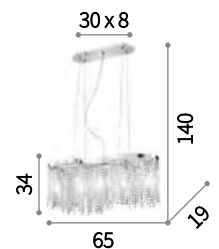

IP20

3,900 Kg / 0,0235 m3
E14 max 5 x 40W

013923 € 370



P. 194



3000 K / 430 Lm
101224 € 2,90



Roma

Montatura e dettagli in metallo cromato.
 Diffusore con elementi quadrati in
 cristallo molato sulla fascia laterale e
 vetro sabbato sul fondo. Sospensioni con
 cavi a lunghezza regolabile.

 Lampadine alogene G9 28W
 2700 K incluse.

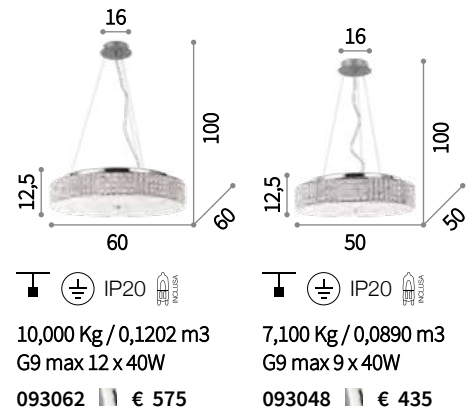



088013

King

Diffusore composto da anelli in metallo cromato o dorato con ottagoni di cristallo incastonati all'interno. Sospensioni con cavi in acciaio a lunghezza regolabile da dispositivi automatici.

 Lampadine alogene G9 28W 2700 K incluse.



088020

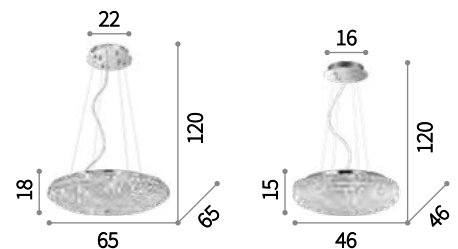

   IP20 INCLUSA

10,000 Kg / 0,1486 m³
G9 max 12 x 40W

088013  € 780
088020  € 880

   IP20 INCLUSA

5,300 Kg / 0,0748 m³
G9 max 7 x 40W

087979  € 450



P. 151

 3000 K / 300 Lm
209043 € 3,50

 3000 K / 300 Lm
209043 € 3,50

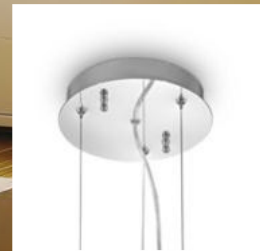



Virgin

Montatura in metallo cromato. Elementi decorativi di cristallo molato in forma di perle e quadrati di varie misure.

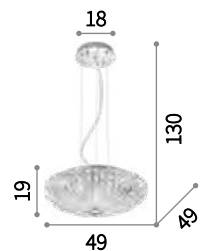
 Lampadine alogene G9 28W 2700 K incluse.



 IP20 
 7,600 Kg / 0,0940 m³
 G9 max 6 x 40W
 023328 € 470





Orion

Diffusore composto da anelli in metallo cromato con ottagoni di cristallo incastonati all'interno. Sospensioni con cavi in acciaio regolabili in lunghezza da dispositivi automatici.

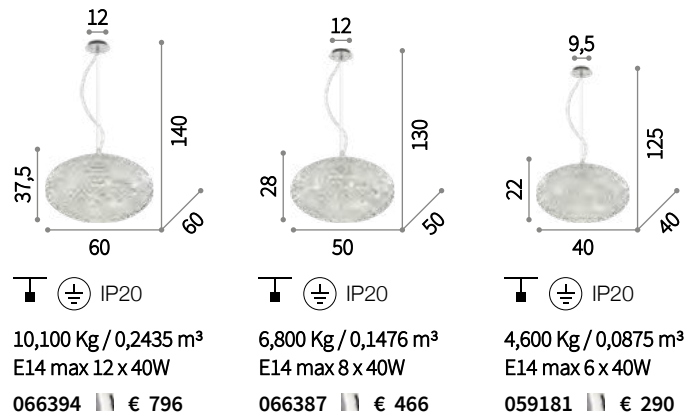

P. 152



P. 196



3000 K / 430 Lm
101200 € 2,90



3000 K / 430 Lm
101200 € 2,90



3000 K / 430 Lm
101200 € 2,90



Calypso

Montatura in metallo cromato. Elementi decorativi in cristallo molato. Sospensioni con cavi in acciaio a lunghezza regolabile da dispositivi ferma cavo automatici.

 Lampadine alogene G9 28W 2700 K incluse nel modello 044187.





 IP20
6,410 Kg / 0,0893 m³
E27 max 5 x 60W
044200 € 464

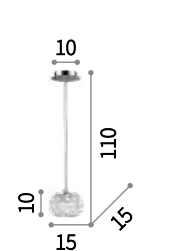

 IP20
4,000 Kg / 0,0566 m³
E27 max 3 x 60W
044194 € 380



 IP20 
1,130 Kg / 0,0138 m³
G9 max 1 x 40W
044187 € 110





P. 153



P. 197

 3000 K / 430 Lm
101279 € 2,90

 3000 K / 430 Lm
101279 € 2,90

 3000 K / 300 Lm
209043 € 3,50



031750

Audi-80

Montatura in metallo cromato. Elementi decorativi con sfere di vetro su fili di metallo. Diffusore in vetro soffiato trasparente o fumé. Cavi in acciaio a lunghezza regolabile con ferma cavo automatici.

 Lampadine alogene G9 28W 2700 K incluse.



197661

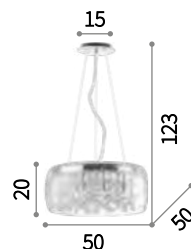

  IP20 

9,560 Kg / 0,1289 m³
G9 max 8 x 40W

031750 € 498
197654 € 578

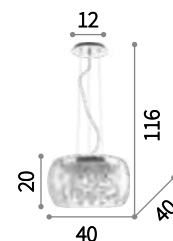

  IP20 

5,890 Kg / 0,0876 m³
G9 max 5 x 40W

031743 € 318
197661 € 387

 3000 K / 300 Lm
209043 € 3,50

 3000 K / 300 Lm
209043 € 3,50



016863



Audi-10

Montatura in metallo cromato. Diffusore in vetro soffiato trasparente o fumè. Cavi in acciaio a lunghezza regolabile con dispositivi ferma cavo automatici.



103983

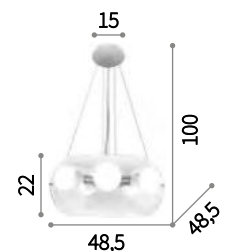

5,520 Kg / 0,1044 m³
E27 max 5x60W

016863 € 320
103983 € 360

LED Lampadine LED E27 8W Globo D95
3000 K incluse. Cod. 101330/101323

3000 K / 720 Lm
101330 € 8,50



Audi-61

Montatura in metallo cromato. Catene di ottagoni in cristallo. Diffusore in vetro soffiato. Sospensioni con cavi in acciaio a lunghezza regolabile da dispositivi automatici.

 Lampadine alogene G9 28W 2700 K incluse.

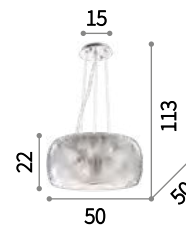

  IP20 

7,790 Kg / 0,1174 m³
G9 max 8 x 40W

133881  € 450

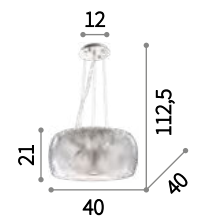

  IP20 

4,570 Kg / 0,0784 m³
G9 max 6 x 40W

133874  € 292



P. 153 P. 197

 3000 K / 300 Lm
209043 € 3,50

 3000 K / 300 Lm
209043 € 3,50

159553



Comfort

Rosone e corpo luce in metallo verniciato opaco bianco, grigio o nero. Cavi in acciaio regolabili. Diffusore in vetro soffiato bianco acidato.



IP20

4,090 Kg / 0,1184 m³
E27 max 1x60W

- 159553 € 225
- 159560 € 225
- 186832 € 225

3000 K / 720 Lm
123899 € 6,90



Tall

Diffusore e dettagli in metallo verniciato bianco o nero opaco. Modello SMALL con led integrato e schermo opale. Modello BIG aperto e con lampadina sostituibile.

LED Sorgente luminosa LED 3000 K nel modello 196794 e 196800, 20.000 h di durata.

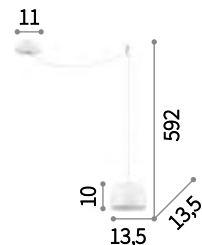

IP20
 0,550 Kg / 0,0036 m³
 E27 max 1 x 42W
 196770 € 95
 196787 € 95



IP20
 0,500 Kg / 0,0024 m³
 LED 4,5W / 510Lm
 196794 € 108
 196800 € 108

3000 K / 360 Lm
 101286 € 3,00



A-Line **new**

Rosone in metallo verniciato a polveri.
Diffusore in metallo verniciato bianco
o nero opaco con interno bianco. Cavo
rivestito in tessuto.

LED

Lampadine LED GU10 7W 3000 K
incluse nei modelli: 232690 e
232713. Cod. 123943

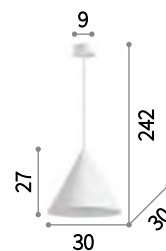

IP20

1,080 Kg / 0,0519 m³
E27 max 1 x 60W

232720 € 58 **new**
232744 € 58 **new**

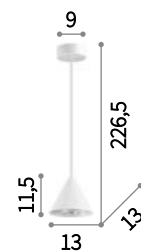

IP20

0,330 Kg / 0,0109 m³
GU10 max 1 x 28W

232690 € 38 **new**
232713 € 38 **new**

3000 K / 720 Lm
123899 € 6,90

3000 K / 640 Lm
123943 € 3,90



Oil

Montatura in metallo con finitura nero opaco. Diffusore in cemento.



144320



110417

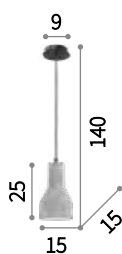

IP20

1,780 Kg / 0,0130 m³
E27 max 1x15W

144320 € 84
110417 € 84

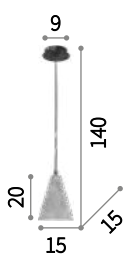

IP20

1,180 Kg / 0,0119 m³
E27 max 1x15W

110424 € 84

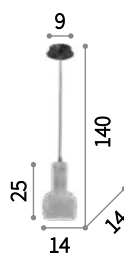

IP20

1,810 Kg / 0,0130 m³
E27 max 1x15W

110431 € 84

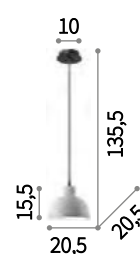

IP20

1,650 Kg / 0,0165 m³
E27 max 1x15W

129082 € 84

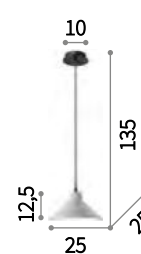

IP20

1,760 Kg / 0,0236 m³
E27 max 1x15W

129099 € 84

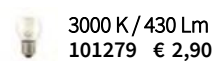
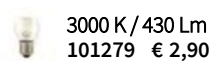
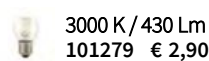
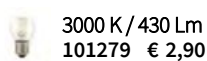
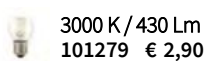





Vinegar **new**

Rosone e diffusore in metallo con finitura ottone satinato oppure in cemento. 12 metri di cavo rivestito in tessuto. Fornito con sei ganci di fissaggio e spina italiana che può essere sostituita al rosone.



⏏ (⊕) IP20

1,490 Kg / 0,0111 m³
GU10 max 1 x 15W

207889 ■ € 100 **new**
110462 ■ € 100

 3000 K / 400 Lm
108292 € 3,50



116464

Mr Jack **new**

Montatura e diffusore sferico in metallo rifinito in bianco, cromo, legno o nero. Cavo elettrico rivestito in tessuto.

LED Lampadine LED GU10 7W 3000 K incluse. Cod. 101378

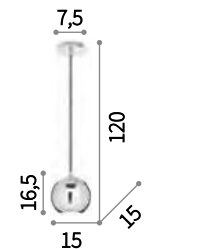

0,890 Kg / 0,0089 m³
GU10 max 1 x 28W

231273 € 70 **new**
140995* € 100 **new**
116464 € 75
231297 € 70 **new**

* GU10 max 1 x 15W

3000 K / 560 Lm
101378 € 6,50

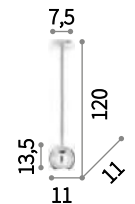

0,520 Kg / 0,0040 m³
GU10 max 1 x 28W

231228 € 60 **new**
140988* € 90 **new**
116457 € 65
231259 € 60 **new**

* GU10 max 1 x 15W

3000 K / 560 Lm
101378 € 6,50





Radio

Rosone e montatura in metallo cromato.
Diffusore posizionabile. Cavo elettrico in tessuto.

LED Lampadine LED E27 8W Globo D125
trasparente 3000 K incluse.
Cod. 101347



P. 198

P. 311

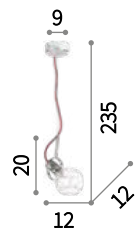

0,560 Kg / 0,0186 m³
E27 max 1x60W

113333 € 65

3000 K / 860 Lm
101347 € 8,90



Minimal

Montatura in metallo rifinito in cromo o in smalto colorato. Cavo elettrico con rivestimento in tessuto. Sospensioni SP1 fornite con due metri di cavo.

LED Lampadine LED E27 8W Globo D125 trasparente 3000 K incluse. Cod. 101347



P. 199 P. 312

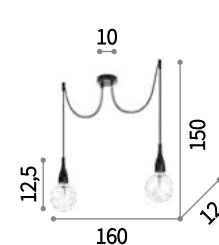

IP20
 0,900 Kg / 0,0171 m³
 E27 max 2 x 60W
 112718 € 98
 112671 € 98

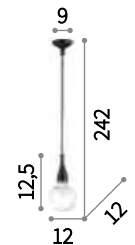

IP20
 0,470 Kg / 0,0099 m³
 E27 max 1 x 70W
 009360 € 54
 009391 € 54
 009414 € 54
 101118 € 54
 009407 € 54

3000 K / 860 Lm
 101347 € 8,90

3000 K / 860 Lm
 101347 € 8,90

Hugo

Rosone e corpo luce in metallo con finitura in vernice opaca nera. Cavo elettrico rivestito in tessuto.

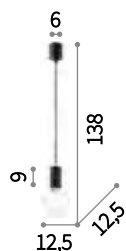

IP20

0,380 Kg / 0,0099 m³
E27 max 1 x 60W

139685 ■ € 30

3000 K / 860 Lm
101347 € 8,90



It

Rosone e copriportalampade in metallo con finitura in smalto opaco nero. Cavo in tessuto.

LED Lampadine LED E27 8W Globo D125 trasparente 3000 K incluse.
Cod. 101347

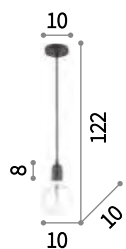

IP20

0,270 Kg / 0,0019 m³
E27 max 1 x 60W

175935 ■ € 29

3000 K / 860 Lm
101347 € 8,90







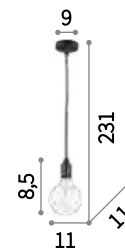

Edison

Montatura in metallo rifinito in smalto opaco bianco o nero. Cavo elettrico in tessuto.

LED Lampadine LED E27 8W Globo D125 trasparente 3000 K incluse.
Cod. 101347



IP20  INCLUSA
0,320 Kg / 0,0098 m³
E27 max 1 x 60W
113302  € 50
113319  € 50

 3000 K / 860 Lm
101347 € 8,90



P. 200



Cognac

Rosone e montatura in metallo verniciato nero opaco. Diffusore in vetro soffiato trasparente con decoro in rilievo.

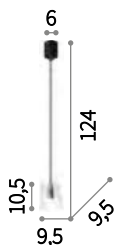

IP20

0,710 Kg / 0,0090 m³
G9 max 1 x 15W

166988 € 45

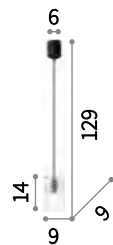

IP20

0,920 Kg / 0,0086 m³
G9 max 1 x 15W

167015 € 45

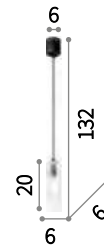

IP20

0,650 Kg / 0,0067 m³
G9 max 1 x 15W

167107 € 45

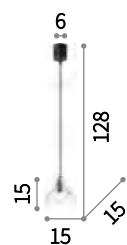

IP20

0,780 Kg / 0,0152 m³
G9 max 1 x 15W

167022 € 45

3000 K / 300 Lm
209043 € 3,50

3000 K / 300 Lm
209043 € 3,50

3000 K / 300 Lm
209043 € 3,50

3000 K / 300 Lm
209043 € 3,50

Flam

Diffusore in vetro pirex smerigliato nella zona centrale. Cavi elettrici regolabili in lunghezza.

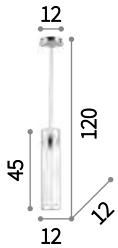

IP20

1,330 Kg / 0,0164 m³
E27 max 1 x 60W

027364 € 49

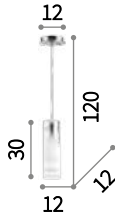

IP20

0,810 Kg / 0,0115 m³
E27 max 1 x 60W

027357 € 45

3000 K / 860 Lm
119571 € 6,50

3000 K / 860 Lm
119571 € 6,50

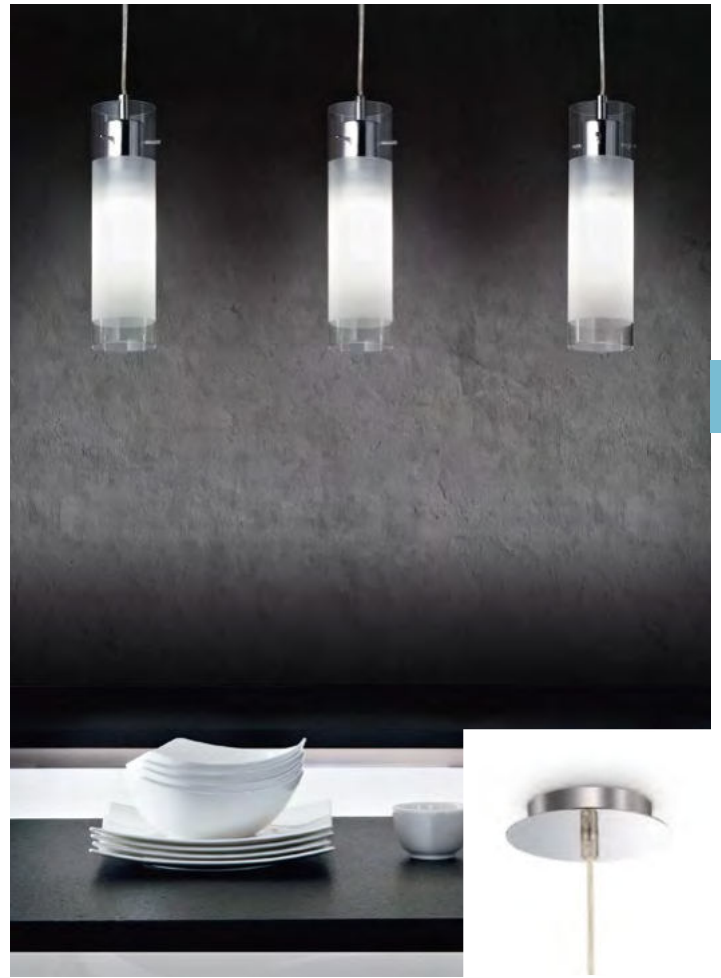

Bar

Diffusore in tubolare di vetro pirex con fascia centrale sabbiata. Cavi elettrici regolabili in lunghezza.

LED Lampadine LED G9 3,2W 3000 K include. Cod. 209043

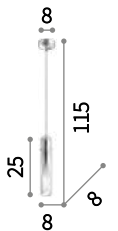

IP20

0,430 Kg / 0,0034 m³
G9 max 1 x 40W

089614 € 42

3000 K / 300 Lm
209043 € 3,50





Iguazù

Montatura in metallo cromato. Diffusore in vetro pirex e pendenti con ottagononi di cristallo. Sospensioni con cavi a lunghezza regolabile da dispositivi ferma cavo automatici.

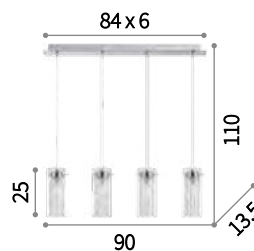

IP20

3,950 Kg / 0,0524 m³
E14 max 4x40W

052373 € 220

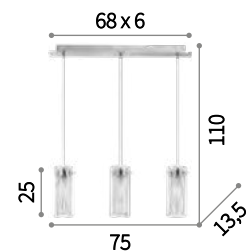

IP20

2,940 Kg / 0,0364 m³
E14 max 3x40W

052366 € 170

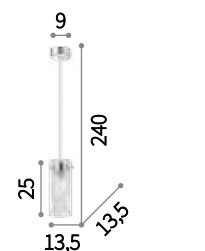

IP20

0,950 Kg / 0,0126 m³
E14 max 1x40W

052359 € 60

3000 K / 430 Lm
101224 € 2,90

3000 K / 430 Lm
101224 € 2,90

3000 K / 430 Lm
101224 € 2,90





Gocce

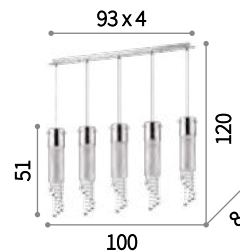

Montatura in metallo cromato. Diffusore in tubolare di vetro pirex. Elementi decorativi con ottagoni e gocce in cristallo molato. Cavi elettrici regolabili in lunghezza.

 Lampadine alogene GU10 28W 2700 K incluse.



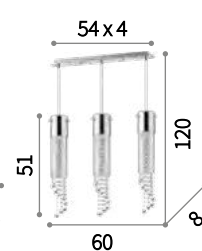

 IP20  INCLUSA
5,500 Kg / 0,0636 m³
GU10 max 5 x 28W
089638 € 450



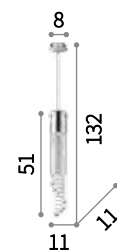

 IP20  INCLUSA
3,420 Kg / 0,0395 m³
GU10 max 3 x 28W
091143 € 300



 IP20  INCLUSA
1,140 Kg / 0,0123 m³
GU 10 max 1 x 28W
089669 € 100

 3000 K / 400 Lm
108292 € 3,50

 3000 K / 400 Lm
108292 € 3,50

 3000 K / 400 Lm
108292 € 3,50



Cono

Montatura e copri porta lampade in metallo cromato o bianco satinato. Diffusore in vetro soffiato a mano. Disponibile in bianco con vetro trasparente e fascia sabbiata, o in cromo con vetro tutto trasparente.

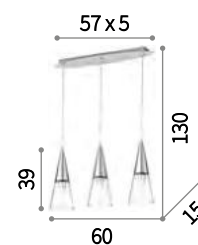

IP20

4,110 Kg / 0,0763 m³
E14 max 3 x 40W

112381 € 208
112367 € 216

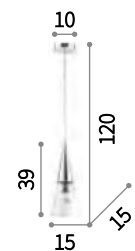

IP20

1,420 Kg / 0,0243 m³
E14 max 1 x 40W

112459 € 82
017440 € 88

3000 K / 430 Lm
101255 € 4,50

3000 K / 430 Lm
101255 € 4,50

023038

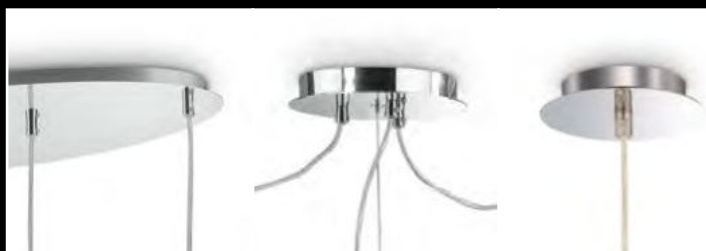

Kuky

Montatura in metallo cromato. Disponibile con vetro pirex smerigliato a sabbia nella zona centrale o vetro bianco soffiato e acidato.

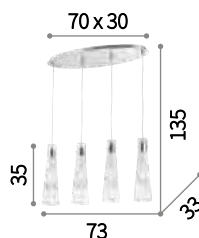

⏏ (⊕) IP20

4,580 Kg / 0,0766 m³
E27 max 4x 60W

023038 € 197
053455 € 197

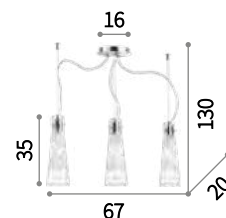

⏏ (⊕) IP20

2,510 Kg / 0,0464 m³
E27 max 3x 60W

033952 € 137

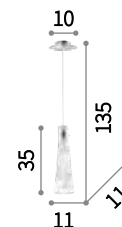

⏏ (⊕) IP20

0,980 Kg / 0,0165 m³
E27 max 1x 60W

023021 € 43
053448 € 43

3000 K / 860 Lm
119571 € 6,50

3000 K / 860 Lm
119571 € 6,50

3000 K / 860 Lm
119571 € 6,50



012919

Olimpia

Montatura in cromo. Diffusore in vetro colorato soffiato e incamiciato. Cavo elettrico regolabile in lunghezza.



013244

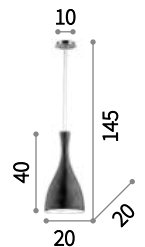

IP20

1,080 Kg / 0,0374 m³
E27 max 1 x 60W

013244 € 108
012919 € 108

3000 K / 720 Lm
123899 € 6,90



Manhattan

Rosone e diffusore in metallo rifinito con vernice opaca bianca o nera e con dettaglio in legno naturale. Cavo in tessuto.

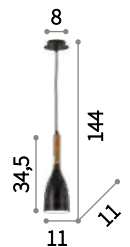

IP20

0,560 Kg / 0,0060 m³
E14 max 1 x 40W

110745 € 56
110752 € 56

3000 K / 430 Lm
101200 € 2,90



Milk

Base ellittica in metallo smaltato bianco. Diffusore in vetro bianco soffiato e acidato. Cavi elettrici regolabili in lunghezza.

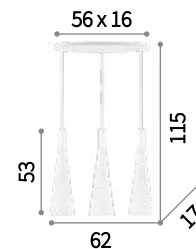

IP20

4,220 Kg / 0,1024 m³
E27 max 3 x 60W

030326 € 215

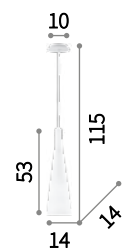

IP20

1,270 Kg / 0,0354 m³
E27 max 1 x 60W

026787 € 84

3000 K / 720 Lm
123899 € 6,90

3000 K / 720 Lm
123899 € 6,90



Cocktail

Diffusore in vetro soffiato incamiciato e acidato. Bianco all'interno e colorato all'esterno. Sospensioni con cavi a lunghezza regolabile.

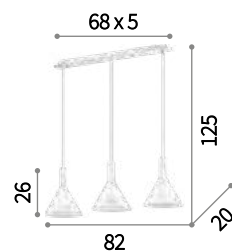

IP20

3,740 Kg / 0,0708 m³
E14 max 3 x 40W

074245 € 200

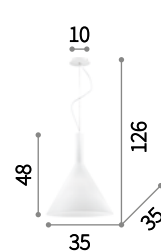

IP20

3,200 Kg / 0,1259 m³
E27 max 1 x 60W

074313 € 225

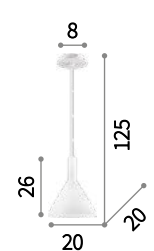

IP20

1,180 Kg / 0,0257 m³
E14 max 1 x 40W

074337 € 80
074344 € 85

3000 K / 360 Lm
101217 € 3,00

3000 K / 720 Lm
123899 € 6,90

3000 K / 360 Lm
101217 € 3,00



Flut

Diffusore in vetro soffiato incamiciato e acidato, bianco all'interno e colorato all'esterno. Cavo a lunghezza regolabile.

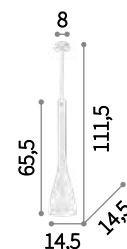

IP20

1,570 Kg / 0,0422 m³
E27 max 1 x 60W

035666 € 110
035673 € 110
035680 € 110

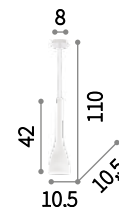

IP20

0,930 Kg / 0,0179 m³
E14 max 1 x 40W

035697 € 57
035703 € 57
035710 € 57

3000 K / 720 Lm
123899 € 6,90

3000 K / 360 Lm
101217 € 3,00

035666





Lido

Montatura in metallo verniciato bianco o cromo. Cavo in tessuto. Diffusori in vetro soffiato bianco acidato o trasparente fumè.

LED Lampadine LED G9 3,2W 3000 K incluse. Cod. 209043

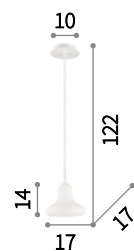

IP20 INCLUSA
 0,790 Kg / 0,0180 m³
 G9 max 1 x 15W
 167626 € 56
 168326 € 56

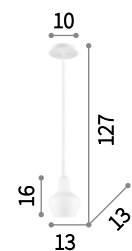

IP20 INCLUSA
 0,790 Kg / 0,0156 m³
 G9 max 1 x 15W
 167640 € 56
 168357 € 56

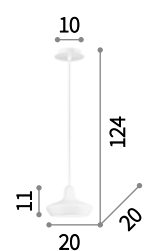

IP20 INCLUSA
 0,660 Kg / 0,0243 m³
 G9 max 1 x 15W
 168319 € 64
 168364 € 64

3000 K / 300 Lm
 209043 € 3,50

3000 K / 300 Lm
 209043 € 3,50

3000 K / 300 Lm
 209043 € 3,50



137261

Aladino

Montatura in metallo smaltato bianco satinato. Diffusore in vetro soffiato incamiciato: acidato il bianco, lucido l'azzurro. Cavi in acciaio a lunghezza regolabile da dispositivi automatici.



137315



IP20

4,180 Kg / 0,0783 m³
E27 max 1 x 60W

137308 € 252
137261 € 302

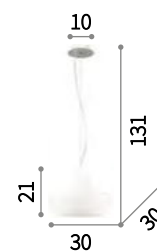

IP20

1,730 Kg / 0,0462 m³
E27 max 1 x 60W

137315 € 125
137292 € 148



P. 264

3000 K / 720 Lm
101330 € 8,50

3000 K / 720 Lm
101330 € 8,50



Soft

Montatura in metallo con finiture bianco, cromo e nero. Diffusori in vetro soffiato bianco, fumè oppure in cemento.

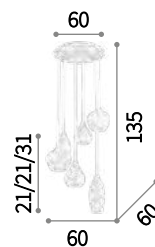

IP20

6,400 Kg / 0,1138 m³
E14 max 6 x 40W

087818 € 225
111841 € 325

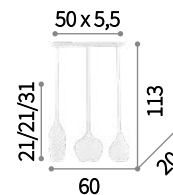

IP20

3,000 Kg / 0,0657 m³
E14 max 3 x 40W

111858 € 135
111865 € 170
179766* € 135

* 10,880 Kg / 0,0878 m³

3000 K / 360 Lm
101217 € 3,00

3000 K / 360 Lm
101217 € 3,00

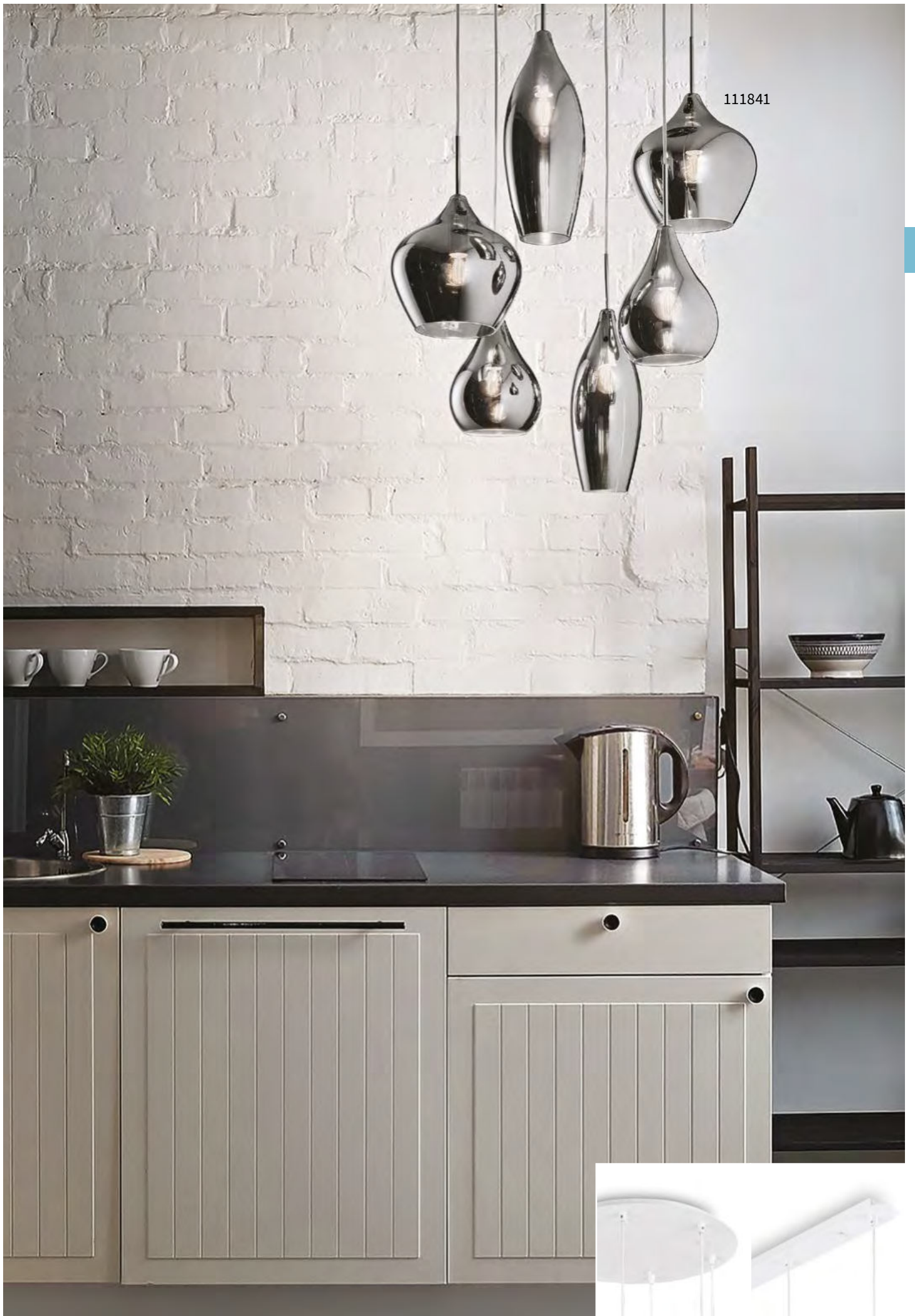

111841





173023

Yoga



Montatura in metallo rifinito con vernice opaca bianca o nera. Diffusori in vetro soffiato completamente trasparente o trasparente satinato.

 Lampadine alogene G9 28W 2700 K incluse.



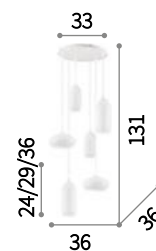

172996

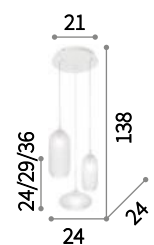

 IP20 
3,000 Kg / 0,0626 m³
G9 max 6 x 40W

173016  € 220
173023  € 220



 IP20 
1,500 Kg / 0,0347 m³
G9 max 3 x 40W

172996  € 115
173009  € 115

 3000 K / 300 Lm
209043 € 3,50

 3000 K / 300 Lm
209043 € 3,50



Sugar

Montatura in metallo cromato. Diffusore in vetro trasparente soffiato e decorato a mano con graniglia all'interno.

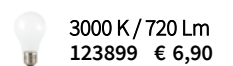
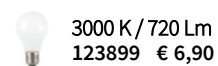
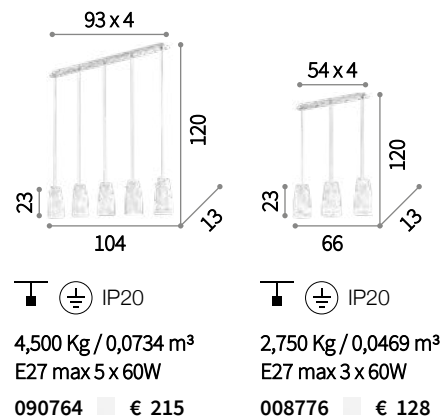

Compo

Montatura in metallo verniciato bianco opaco. Elementi diffusori in vetro soffiato bianco incamiciato e acidato.

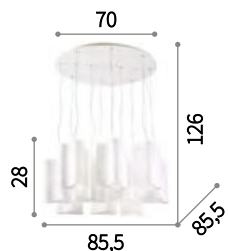

IP20

16,940 Kg / 0,2896 m³
E27 max 10 x 60W

208053 € 782

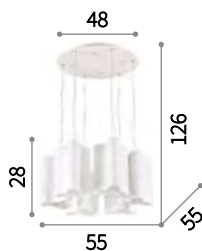

IP20

9,820 Kg / 0,1392 m³
E27 max 6 x 60W

208046 € 464

3000 K / 860 Lm
119571 € 6,50

3000 K / 860 Lm
119571 € 6,50



P. 154



Sesto

Montatura in metallo cromato. Diffusore in vetro soffiato bianco e acidato. Cavi in acciaio a lunghezza regolabile con dispositivi ferma cavo automatici.



IP20

4,120 Kg / 0,0776 m³
E27 max 1 x 60W

115740 € 194



IP20

1,840 Kg / 0,0476 m³
E27 max 1 x 60W

132228 € 130

3000 K / 720 Lm
123899 € 6,90

3000 K / 720 Lm
123899 € 6,90





Origami

Montatura in metallo verniciato opaco.
Diffusori in vetro bianco soffiato e acidato
con effetto piegature in rilievo.



IP20

3,740 Kg / 0,0642 m³
E27 max 3 x 60W

198095 € 230



IP20

1,140 Kg / 0,0216 m³
E27 max 1 x 60W

200583 € 78



IP20

0,990 Kg / 0,0179 m³
E27 max 1 x 60W

200590 € 78



IP20

1,100 Kg / 0,0253 m³
E27 max 1 x 60W

200606 € 78

3000 K / 720 Lm
123899 € 6,90

3000 K / 720 Lm
123899 € 6,90

3000 K / 720 Lm
123899 € 6,90

3000 K / 720 Lm
123899 € 6,90



Cylinder

Montatura in metallo. Diffusore in vetro soffiato bianco acidato. Cavi in acciaio a lunghezza regolabile con dispositivi ferma cavo automatici.



IP20

4,040 Kg / 0,0729 m³
E27 max 1 x 100W

025438 € 180

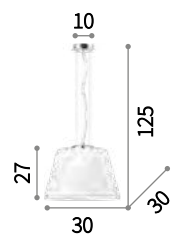

IP20

2,290 Kg / 0,0363 m³
E27 max 1 x 100W

025421 € 125



P. 294

3000 K / 720 Lm
101354 € 9,00

3000 K / 720 Lm
101354 € 9,00



Tolomeo

Diffusore in vetro soffiato, incamiciato e decorato a mano. Cavi in acciaio a lunghezza regolabile con dispositivi ferma cavo automatici.

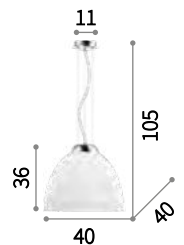

IP20

3,390 Kg / 0,0871 m³
E27 max 1x100W

001814 € 220
001821 € 220

3000 K / 720 Lm
101354 € 9,00

Blossom ^{new}

Montatura e rosone in metallo cromato.
Diffusore in vetro soffiato trasparente con
finitura ambra o fumè. Cavo elettrico in pvc
trasparente.

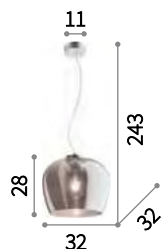

IP20

1,890 Kg / 0,0705 m³
E27 max 1 x 60W

241524 € 130 ^{new}
241517 € 130 ^{new}

3000 K / 720 Lm
101354 € 9,00



Audi-20

Elemento centrale portalampada in
metallo cromato. Diffusore in vetro soffiato
trasparente o cromo sfumato. Cavo in acciaio
a lunghezza regolabile con dispositivo ferma
cavo automatico.

LED Lampadine LED E27 8W Globo D125
3000 K incluse. Cod. 101347/101354

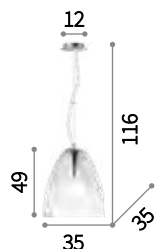

IP20

4,370 Kg / 0,1017 m³
E27 max 1 x 100W

016931 € 228
103990 € 250

3000 K / 720 Lm
101354 € 9,00





101095



Eva

Montatura in metallo cromato. Diffusore in vetro soffiato. Disponibile in vetro bianco incamiciato e acidato o trasparente con effetto fumè. Cavi in acciaio a lunghezza regolabile da dispositivi automatici.



077697

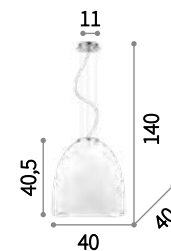

IP20

5,750 Kg / 0,1201 m³
E27 max 1 x 60W

077703 € 245
101095 € 317

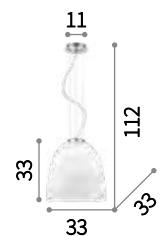

IP20

3,600 Kg / 0,0741 m³
E27 max 1 x 60W

077697 € 192
101101 € 248

3000 K / 860 Lm
101347 € 8,90

3000 K / 860 Lm
101347 € 8,90



Karma

Montatura in metallo cromato. Diffusore in vetro soffiato bianco incamiciato e acidato. Cavi in acciaio a lunghezza regolabile da dispositivi ferma cavo automatici.



IP20

4,310 Kg / 0,1185 m³
E27 max 1 x 60W

132365 € 200

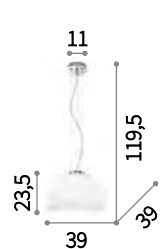

IP20

3,700 Kg / 0,0693 m³
E27 max 1 x 60W

132389 € 200

3000 K / 720 Lm
101354 € 9,00

3000 K / 720 Lm
101354 € 9,00

Etna

Montatura in metallo con finitura nickel satinato. Diffusore in vetro bianco soffiato e acidato.

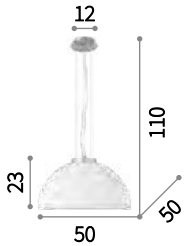

⚡ IP20

4,390 Kg / 0,1072 m³
E27 max 1 x 100W
027906 € 307

💡 3000 K / 720 Lm
101354 € 9,00



Don

Montatura e diffusore in metallo rifinito con vernice bianca opaca all'esterno e lucida all'interno.



⚡ IP20

3,510 Kg / 0,0933 m³
E27 max 1 x 60W
103136 € 215

💡 3000 K / 860 Lm
101347 € 8,90

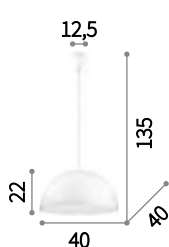

⚡ IP20

1,900 Kg / 0,0587 m³
E27 max 1 x 60W
103112 € 115

💡 3000 K / 860 Lm
101347 € 8,90



Pandora

Montatura e diffusore in metallo con interno smaltato bianco. Esterno disponibile in nickel o bianco opaco. Cavo elettrico regolabile in lunghezza.

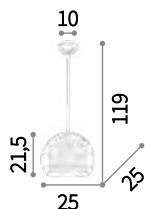

IP20

1,000 Kg / 0,0313 m³
E27 max 1 x 60W

005218 € 77

3000 K / 720 Lm
101330 € 8,50



Aria

Diffusore in vetro bianco soffiato e acidato. Cavi in acciaio a lunghezza regolabile con dispositivi ferma cavo automatici.

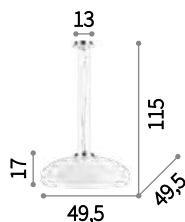

IP20

4,080 Kg / 0,0721 m³
E27 max 1 x 60W

059679 € 230

3000 K / 720 Lm
101330 € 8,50





Mama

Montatura e anello sul bordo inferiore in metallo rifinito con smalto bianco satinato. Diffusore in vetro bianco soffiato e acidato. Cavi in acciaio a lunghezza regolabile da dispositivi automatici.

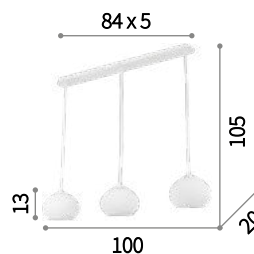

IP20

3,500 Kg / 0,0644 m³
E27 max 3 x 60W

093307 € 233



IP20

4,170 Kg / 0,1223 m³
E27 max 3 x 60W

071022 € 283

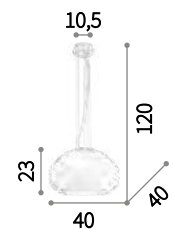

IP20

2,810 Kg / 0,0699 m³
E27 max 1 x 60W

071015 € 157

3000 K / 720 Lm
123899 € 6,90

3000 K / 720 Lm
101354 € 9,00

3000 K / 720 Lm
101330 € 8,50



Lana

Diffusore in vetro trasparente con decorazioni serigrafate all'interno e sabbiate all'esterno. Ganci ferma vetro in metallo cromato.

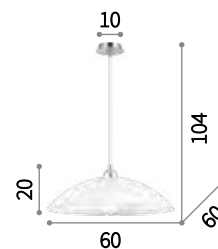

IP20

3,700 Kg / 0,0811 m³
E27 max 1 x 60W

068176 € 122

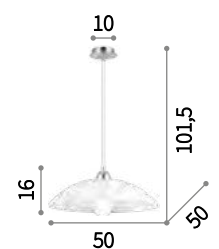

IP20

2,720 Kg / 0,0533 m³
E27 max 1 x 60W

068169 € 90



P. 163 P. 202

3000 K / 720 Lm
101330 € 8,50

3000 K / 720 Lm
101330 € 8,50



Lena

Montatura in metallo cromato. Diffusore con doppio vetro: smerigliato e colorato quello esterno, bianco quello interno. Sospensioni con cavi in acciaio a lunghezza regolabile da dispositivi automatici.

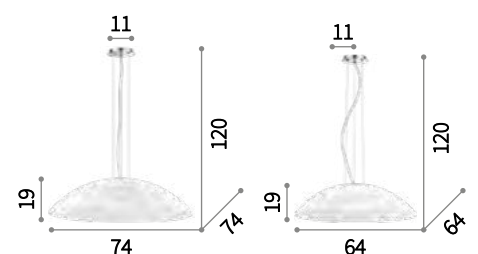

IP20

8,310 Kg / 0,1785 m³
E27 max 3 x 60W

052786 € 318

IP20

6,600 Kg / 0,1304 m³
E27 max 3 x 60W

035727 € 258
066592 € 272
066608 € 272

3000 K / 720 Lm
123899 € 6,90

3000 K / 720 Lm
123899 € 6,90



Smarties

Montatura in metallo. Diffusore in vetro bianco soffiato e acidato oppure trasparente e sabbiato nella zona centrale. Per le sospensioni, cavi in acciaio a lunghezza regolabile con dispositivi ferma cavo automatici.

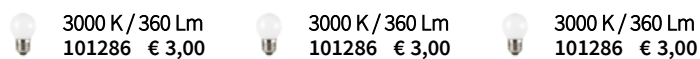
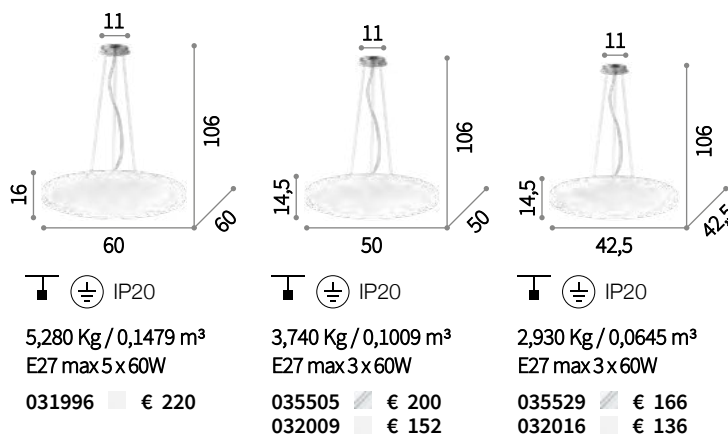



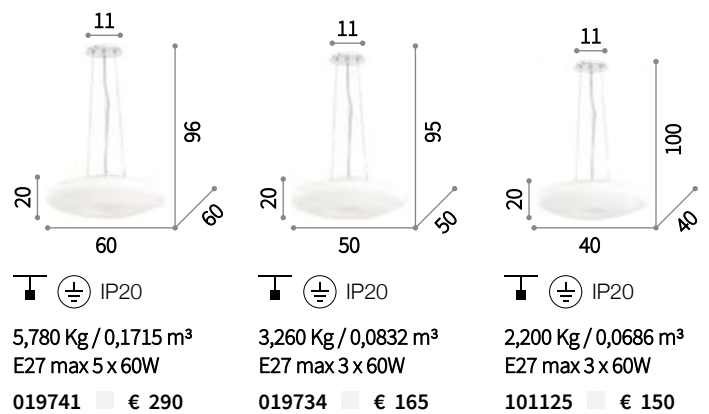

Glory

Montatura rifinita in nickel satinato.
Diffusore in vetro bianco soffiato e acidato. Sospensioni con cavi in acciaio regolabili in lunghezza con dispositivi automatici.



P. 159

 3000 K / 360 Lm
101286 € 3,00

 3000 K / 360 Lm
101286 € 3,00

 3000 K / 360 Lm
101286 € 3,00

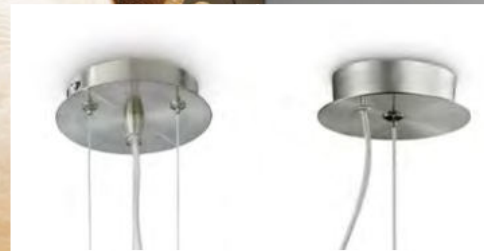

Candy

Montatura in metallo con finitura nickel satinato. Diffusore in vetro bianco soffiato e acidato. Cavi in acciaio a lunghezza regolabile con dispositivi ferma cavo automatici.



Lampadine alogene G9 28W 2700 K incluse nel modello 086729.



IP20

4,200 Kg / 0,1547 m³
E27 max 1 x 60W

086743 € 280

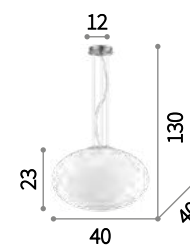

IP20

3,100 Kg / 0,0778 m³
E27 max 1 x 60W

086736 € 160

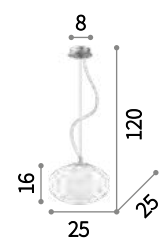

IP20

1,200 Kg / 0,0296 m³
G9 max 1 x 40W

086729 € 70



P. 161



P. 265



3000 K / 720 Lm
123899 € 6,90



3000 K / 720 Lm
123899 € 6,90



3000 K / 300 Lm
209043 € 3,50

Ulisse

Montatura in metallo verniciato bianco opaco. Diffusore in vetro bianco soffiato e acidato. Sospensioni con cavi in acciaio a lunghezza regolabile da dispositivi automatici.

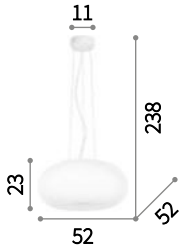

5,010 Kg / 0,1177 m³
E27 max 3 x 60W

098616 € 235



3,110 Kg / 0,0720 m³
E27 max 3 x 60W

095226 € 147

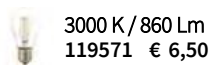
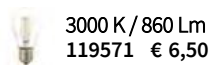

P. 160

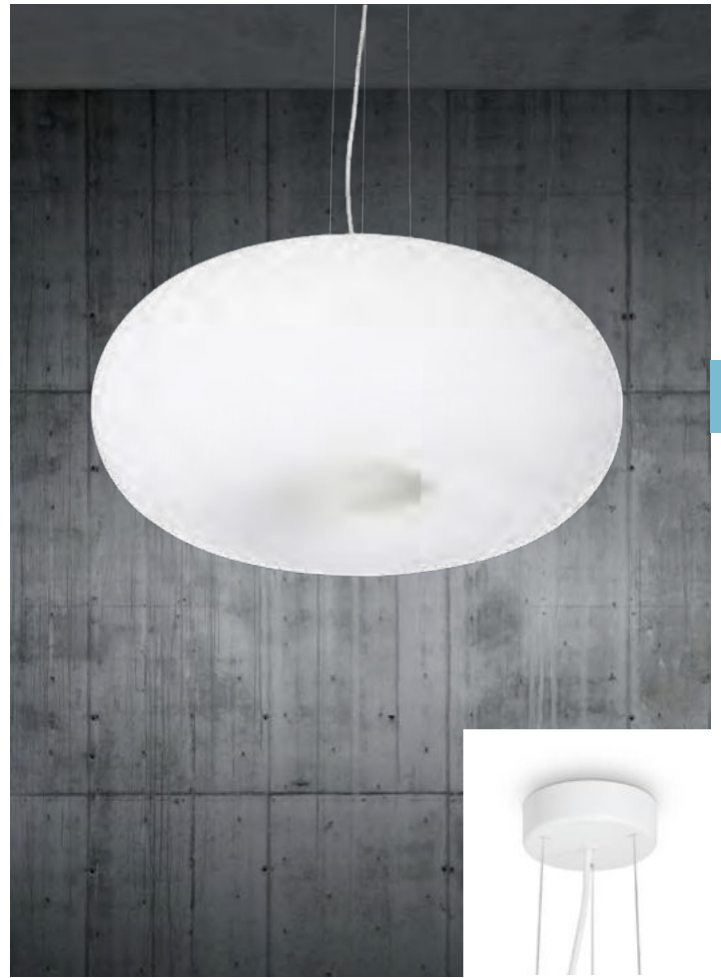

Arizona

Montatura in metallo rifinito in ottone satinato. Diffusore in vetro bianco soffiato, acidato e con rigature decorative in rilievo.

LED Lampadine LED GX53 9,5W 3000 K include. Cod. 123936

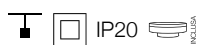
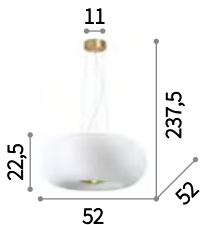

6,190 Kg / 0,1288 m³
GX53 max 5 x 15W

214481 € 430



3,260 Kg / 0,0740 m³
GX53 max 3 x 15W

214474 € 310

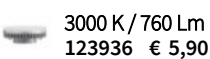
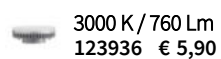

P. 160





Diamond

Montatura in metallo cromato. Diffusore in vetro bianco soffiato e acidato. Cavi in acciaio a lunghezza regolabile con dispositivi ferma cavo automatici.

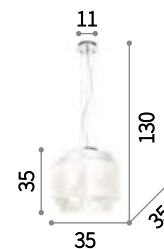

IP20

4,000 Kg / 0,0882 m³
E27 max 1 x 60W

022499 € 225

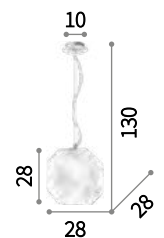

IP20

2,700 Kg / 0,0544 m³
E27 max 1 x 60W

022505 € 158

3000 K / 720 Lm
123899 € 6,90

3000 K / 720 Lm
123899 € 6,90



Ovalino

Diffusore composto da elementi circolari in lastra di vetro curvata e acidata. Cavi in acciaio regolabili in lunghezza da dispositivi automatici.

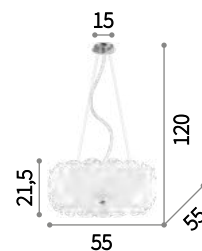

IP20

6,700 Kg / 0,1448 m³
E27 max 8 x 60W

090481 € 240

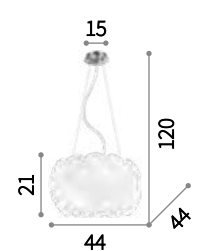

IP20

4,810 Kg / 0,1184 m³
E27 max 5 x 60W

074139 € 190



P. 162 P. 203

3000 K / 720 Lm
123899 € 6,90

3000 K / 720 Lm
123899 € 6,90

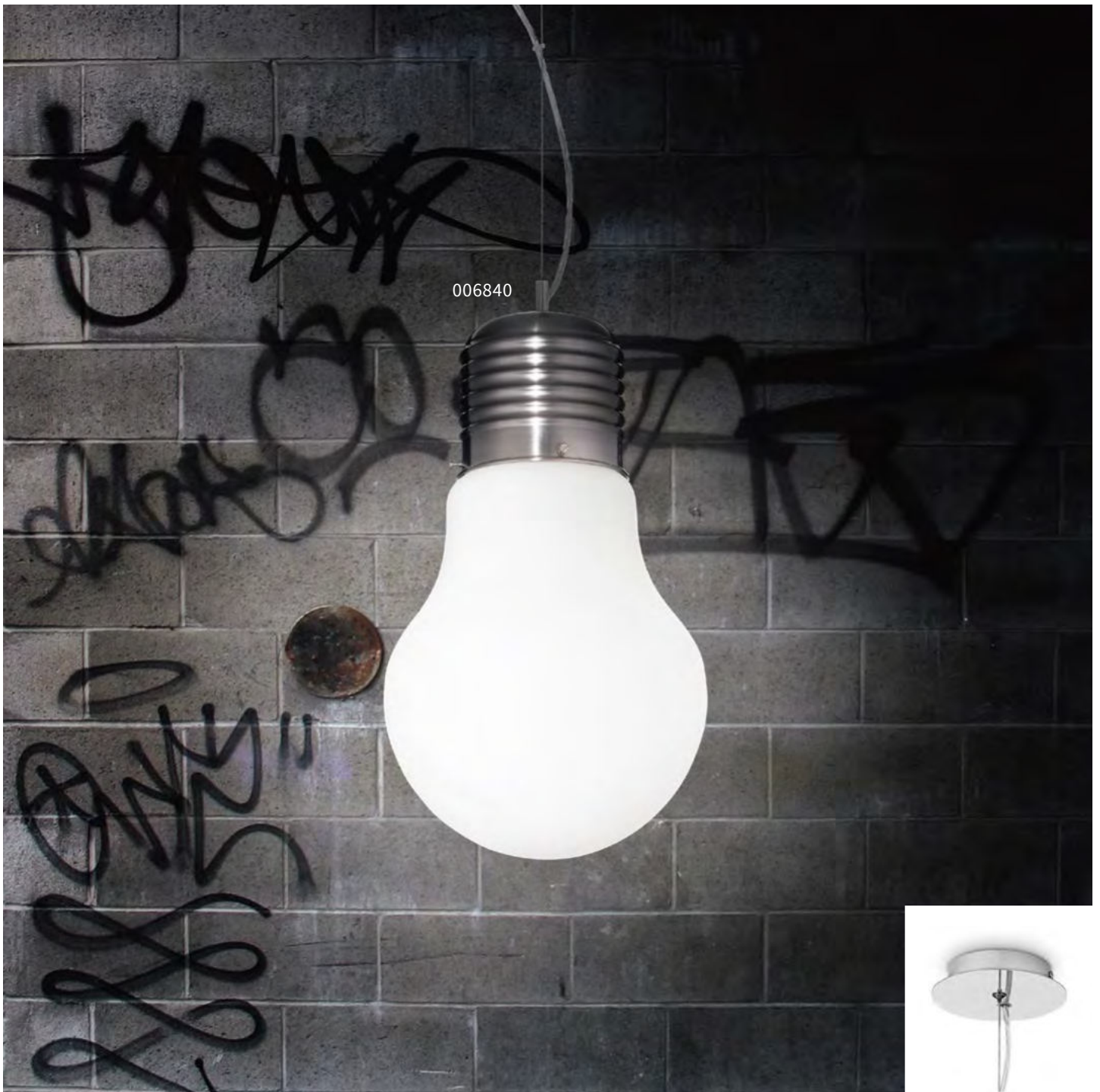

006840



Luce

Montatura in metallo cromato o con finitura nickel satinato per la versione bianca. Diffusore in vetro soffiato trasparente e cromato nella parte superiore o bianco soffiato e acidato. Cavo in acciaio a lunghezza regolabile da dispositivo ferma cavo automatico.



026749

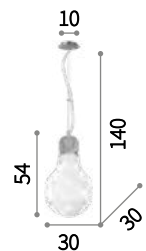

IP20

2,310 Kg / 0,0799 m³
E27 max 1x60W

006840 € 137
026749 € 156

3000 K / 860 Lm
119571 € 6,50



Luce Max

Montatura in cromo. Diffusore in vetro soffiato con decorazione interna in filo d'alluminio. Sospensioni con cavo in acciaio a lunghezza regolabile da dispositivo ferma cavo automatico.

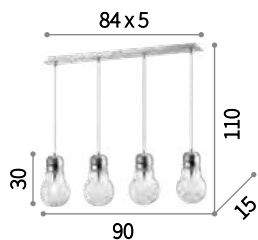

IP20

4,150 Kg / 0,0851 m³
E27 max 4 x 60W

047799 € 182

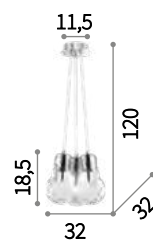

IP20

2,150 Kg / 0,0458 m³
E27 max 3 x 60W

081762 € 163

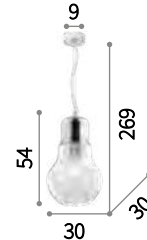

IP20

2,460 Kg / 0,0732 m³
E27 max 1 x 60W

033662 € 92

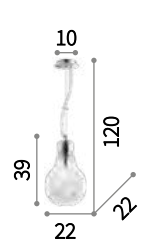

IP20

1,500 Kg / 0,0334 m³
E27 max 1 x 60W

033679 € 65



P. 266



3000 K / 860 Lm
119571 € 6,50



3000 K / 860 Lm
119571 € 6,50



3000 K / 860 Lm
119571 € 6,50



3000 K / 860 Lm
119571 € 6,50



088938



088921



088969



Zeno

Montatura in metallo cromato. Diffusore in vetro soffiato trasparente e colorato. Cavo elettrico regolabile in lunghezza.

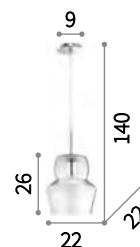

IP20

1,370 Kg / 0,0231 m³
E27 max 1 x 60W

088921 € 85
088938 € 85
088969 € 85

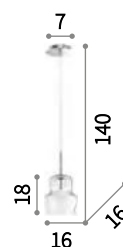

IP20

0,900 Kg / 0,0132 m³
E14 max 1 x 40W

003108 € 76
002040 € 76
036120 € 76

3000 K / 860 Lm
119571 € 6,50

3000 K / 860 Lm
119571 € 6,50

Ken

Montatura in metallo cromato. Diffusore in vetro soffiato. Cavi in acciaio a lunghezza regolabile con dispositivi ferma cavo automatici.

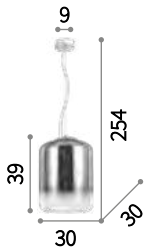

IP20

3,050 Kg / 0,0862 m³
E27 max 1 x 60W

112107 € 250

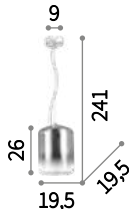

IP20

1,520 Kg / 0,0309 m³
E27 max 1 x 60W

112084 € 150

3000 K / 860 Lm
119571 € 6,50

3000 K / 860 Lm
119571 € 6,50



Cin Cin

Rosone e montatura in metallo cromato. Diffusori in vetro soffiato trasparente con decorazione interna in filo d'alluminio. Cavi regolabili in lunghezza.

 Lampadine alogene G4 20W 2700 K incluse.

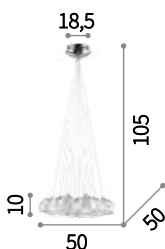

IP20

3,950 Kg / 0,0882 m³
G4 max 11 x 20W

060224 € 430

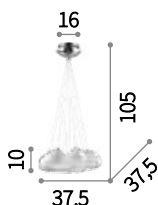

IP20

2,480 Kg / 0,0538 m³
G4 max 7 x 20W

060231 € 300

3000 K / 170 Lm
222257 € 3,90

3000 K / 170 Lm
222257 € 3,90



176000



Mapa Sat

Montatura in metallo con finitura nickel o ottone. Diffusore in vetro soffiato trasparente con decoro interno in filo d'alluminio.



176031

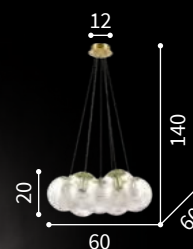

IP20

6,550 Kg / 0,1862 m³
E27 max 7 x 60W

176062 € 424
176000 € 424

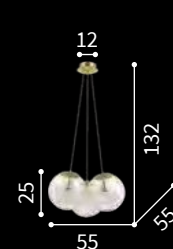

IP20

2,700 Kg / 0,1210 m³
E27 max 3 x 60W

176031 € 240
175973 € 240

3000 K / 860 Lm
119571 € 6,50

3000 K / 860 Lm
119571 € 6,50



Mapa Max

Montatura in cromo. Diffusore in vetro soffiato con decorazione interna in filo d'alluminio. Sospensioni con cavo in acciaio a lunghezza regolabile da dispositivo ferma cavo automatico.

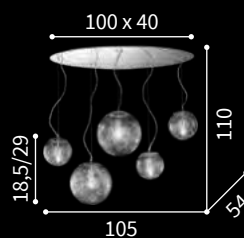

IP20

8,700 Kg / 0,2456 m³
E27 max 5 x 60W

091112 ■ € 440

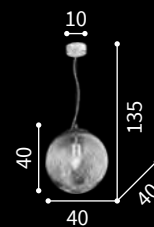

IP20

3,450 Kg / 0,1370 m³
E27 max 1 x 60W

045122 ■ € 130

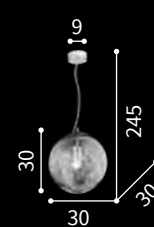

IP20

1,370 Kg / 0,0527 m³
E27 max 1 x 60W

045115 ■ € 92



P. 267

3000 K / 860 Lm
119571 € 6,50

3000 K / 860 Lm
119571 € 6,50

3000 K / 860 Lm
119571 € 6,50



Mapa

Montatura in metallo cromato o bianco.
Diffusore a sfera in vetro bianco soffiato e acidato, con decorazione dipinta o in vetro trasparente cromato con sfumatura verso il basso. Sospensioni con cavi in acciaio a lunghezza regolabile.



161365, 161372, 161389

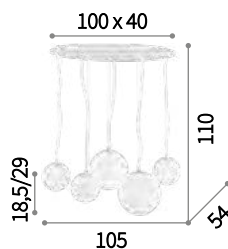

IP20

8,700 Kg / 0,2470 m³
E27 max 5 x 60W

043562 € 430
140759 € 517

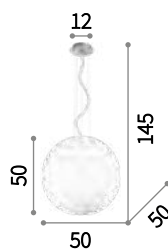

IP20

5,390 Kg / 0,2254 m³
E27 max 1 x 60W

032122 € 278
161365 € 298
161327 € 383

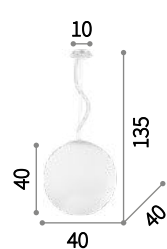

IP20

3,620 Kg / 0,1215 m³
E27 max 1 x 60W

032139 € 123
161372 € 208
161334 € 216

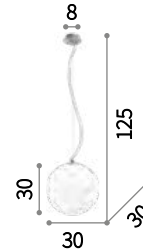

IP20

1,920 Kg / 0,0630 m³
E27 max 1 x 60W

009087 € 64
161389 € 110
140728 € 128

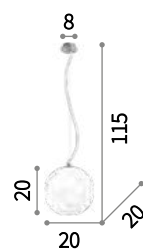

IP20

1,130 Kg / 0,0272 m³
E27 max 1 x 60W

009148 € 42
140711 € 77



P. 162 P. 204 P. 268



3000 K / 860 Lm
119571 € 6,50



3000 K / 860 Lm
119571 € 6,50



3000 K / 860 Lm
119571 € 6,50



3000 K / 860 Lm
119571 € 6,50



3000 K / 860 Lm
119571 € 6,50



161327

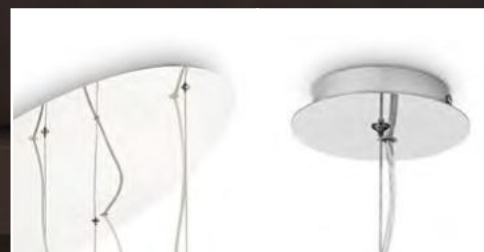



Mapa Plus

Montatura in metallo. Diffusore a sfera in vetro bianco soffiato e acidato. Cavi in acciaio a lunghezza regolabile.

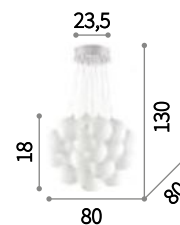

IP20

10,800 Kg / 0,1976 m³
E14 max 22 x 40W

140230 € 540



IP20

5,520 Kg / 0,1205 m³
E14 max 11 x 40W

131924 € 324

3000 K / 360 Lm
101217 € 3,00

3000 K / 360 Lm
101217 € 3,00



Carta **new**

Montatura in metallo verniciato bianco opaco. Diffusore in policarbonato con rivestimento ad effetto carta. Cavo rivestito in tessuto.



P. 269

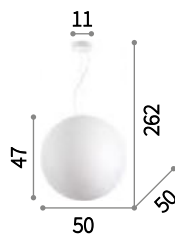

■ □ IP20

1,780 Kg / 0,1601 m³
E27 max 1x25W

226040 ■ € 275 **new**

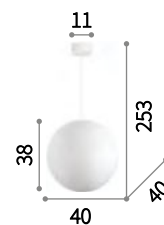

■ □ IP20

1,460 Kg / 0,0880 m³
E27 max 1x25W

226033 ■ € 170 **new**

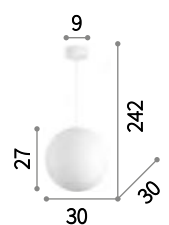

■ □ IP20

0,860 Kg / 0,0404 m³
E27 max 1x25W

226026 ■ € 85 **new**



3000 K / 720 Lm
101354 € 9,00



3000 K / 720 Lm
101354 € 9,00



3000 K / 720 Lm
101354 € 9,00



Boa

Montatura in metallo verniciato opaco bianco o nero. Cavo in tessuto da 12 metri con 6 supporti. Diffusore in vetro soffiato bianco acidato.

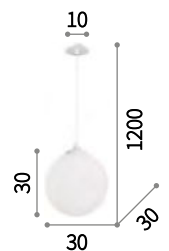
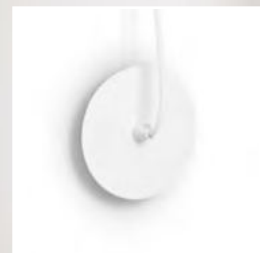

IP20

2,900 Kg / 0,0726 m³
E27 max 1x60W

160863 ■ € 115
160856 ■ € 115

3000 K / 720 Lm
123899 € 6,90



Penombra

Montatura e vela superiore in metallo rifinito in ottone. Diffusore in vetro bianco soffiato e acidato.

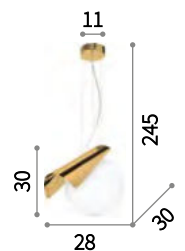

IP20

2,070 Kg / 0,0710 m³
E27 max 1x60W

176734 € 175



P. 204 P. 269

3000 K / 720 Lm
123899 € 6,90



Riga **new**

Rosone e montatura in metallo verniciato nero opaco. Cavi in pvc. Diffusore in vetro soffiato ambra o fumè con rigatura in rilievo.

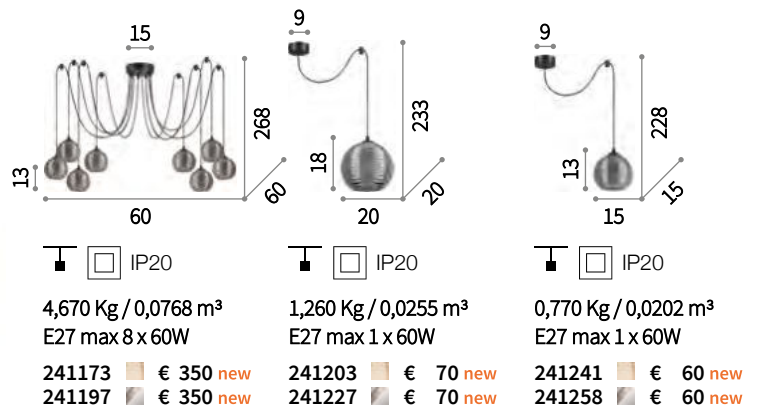

3000 K / 430 Lm
101279 € 2,90

3000 K / 430 Lm
101279 € 2,90

3000 K / 430 Lm
101279 € 2,90



250373



Nemo Plus **new**

Montatura in cromo. Diffusore in vetro soffiato, disponibile nella versione cromata o cromo sfumato. Sospensioni con cavo in acciaio a lunghezza regolabile da dispositivo ferma cavo automatico.



149561

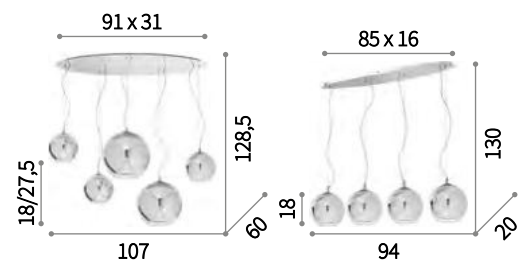

IP20

8,700 Kg / 0,2424 m³
E27 max 5 x 60W

138305 € 626
250373 € 554 **new**

IP20

4,500 Kg / 0,0873 m³
E27 max 4 x 60W

149561 € 356
250366 € 333 **new**

3000 K / 860 Lm
119571 € 6,50

3000 K / 860 Lm
119571 € 6,50



Nemo **new**

Diffusore in vetro soffiato. Disponibile in versione fumé, trasparente, rame o cromo sfumato. Modello 052793 con copri lampada in vetro bianco soffiato e acidato.

LED Lampadine LED G9 3,2W 3000 K incluse nel modello 052793. Cod. 209043

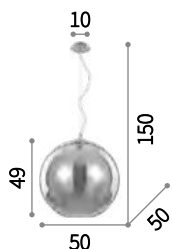

IP20

4,000 Kg / 0,2200 m³
E27 max 1x60W

094137 € 350

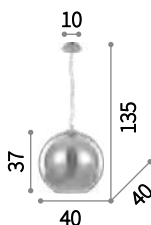

IP20

3,490 Kg / 0,1227 m³
E27 max 1x60W

052816 € 215
250359 € 215 **new**
094229 € 215
250342 € 215 **new**
111919 € 215

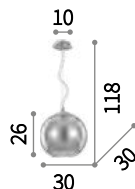

IP20

2,960 Kg / 0,0664 m³
E27 max 1x60W

052809 € 150
149592 € 150
094236 € 150
250335 € 150 **new**
111902 € 150

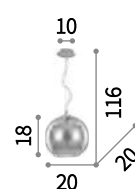

IP20

1,300 Kg / 0,0257 m³
E27 max 1x60W

149585 € 75
250311 € 75 **new**
250304 € 75 **new**
250328 € 75 **new**

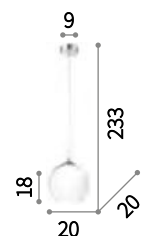

IP20

1,080 Kg / 0,0287 m³
G9 max 1x40W

052793 € 75

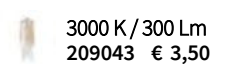
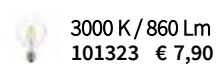
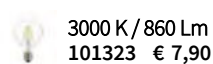
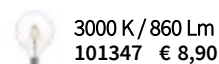
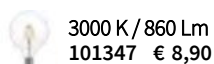





239132



Lea **new**

Rosone e montatura in metallo verniciato bianco o nero opaco. Diffusore in materiale plastico di colore opale.

LED Sorgente luminosa LED 3000 K, 30.000 h di durata.



239163

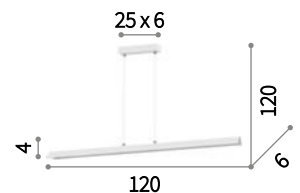

IP20

1,930 Kg / 0,0110 m³
LED 23W / 550 Lm

239132 € 180 **new**
239163 € 180 **new**



235141

Rail **new**

Rosone e montatura in metallo verniciato a polveri di colore nero. Doppi diffusori in materiale plastico colore opale. Cavi in pvc trasparente.

LED Sorgente luminosa LED 3000 K, 30.000 h di durata.



235134

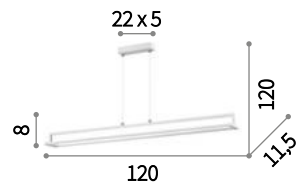

IP20

1,580 Kg / 0,0141 m³
LED 30W / 720 Lm

235134 € 220 **new**
235141 € 220 **new**



Subway **new**

Montatura in metallo verniciato bianco opaco. Diffusore cilindrico in vetro bianco. Cavi elettrici in pvc trasparente.

LED Sorgente luminosa LED 3000 K, 20.000 h di durata.

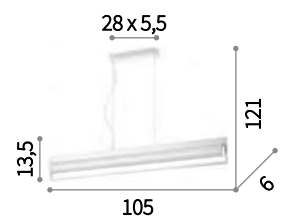

IP20

2,490 Kg / 0,0363 m³
LED 24W / 1970 Lm

224497 € 225 **new**

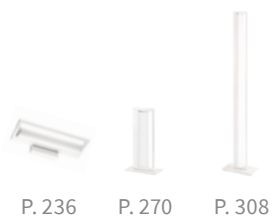

P. 236 P. 270 P. 308



179612

Shots

Montatura in metallo rifinito in bianco o nero opaco, cavi in tessuto, snodi cromati.
Diffusori orientabili con elementi in acrilico satinato.

LED Sorgente luminosa LED 3000 K,
30.000 h di durata.



186825



IP20

2,700 Kg / 0,0315 m³
LED 30W / 2400 Lm

186825 € 335
179612 € 335



Dynamite **new**

Montatura in metallo verniciato a polveri o placcato. Diffusori orientabili. Cavo elettrico in tessuto. Sospensioni con incluso kit per installazione anche a plafone.

LED Lampadine LED GU10 7W 3000 K include. Cod.123943



231433



231396

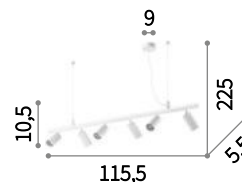

2,700 Kg / 0,0280 m³
GU10 max 6 x 28W

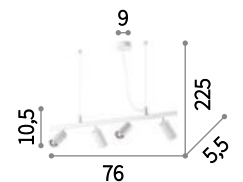

2,310 Kg / 0,0179 m³
GU10 max 4 x 28W

- | | | | |
|--------|------------------|--------|------------------|
| 231433 | € 335 new | 231372 | € 245 new |
| 244648 | € 360 new | 244624 | € 270 new |
| 231396 | € 335 new | 231341 | € 245 new |



P. 189

3000 K / 640 Lm
123943 € 3,90

3000 K / 640 Lm
123943 € 3,90



235929



Zoom **new**

Montatura in metallo verniciato bianco o nero opaco. Diffusori cilindrici orientabili con decorazione zigrinata e schermo opale. Cavo elettrico in pvc.

LED Sorgente luminosa LED 3000 K, 20.000 h di durata.



235936

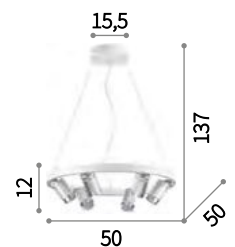

IP20

3,070 Kg / 0,0454 m³
LED 28W / 1120 Lm

235936 € 350 **new**
235929 € 350 **new**



219721

Luxury

Montatura in metallo rifinita in ottone o cromo. Base nera opaca. Paralume in pvc con bordi in tessuto.

219738

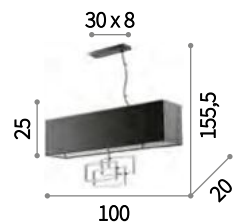

IP20

3,260 Kg / 0,1302 m³
E14 max 6x40W

219721 € 424
219738 € 445

3000 K / 430 Lm
101200 € 2,90



P. 205 P. 270 P. 293



101163

Phoenix

Montatura in metallo cromato. Paralume con telaio in metallo e rivestimento in tessuto. Elementi decorativi con catene di ottagoni in cristallo molato. Sospensioni con cavi in acciaio regolabili in lunghezza da dispositivi automatici.

099101

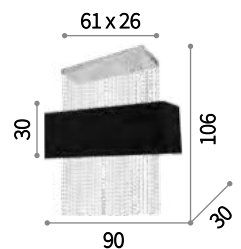

IP20

8,400 Kg / 0,1030 m³
E27 max 5 x 60W

099101 € 660
101163 € 660

3000 K / 720 Lm
123899 € 6,90



P. 163



P. 205



P. 293



Ekos

Montatura in metallo con finitura bianco opaco. Paralumi in lamina di PVC rivestita di tessuto canvas.

LED Lampadine LED G9 3,2W 3000 K include. Cod. 209043

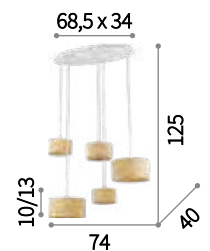

IP20
 3,950 Kg / 0,0917 m³
 G9 max 5 x 40W
 110868 € 280

3000 K / 300 Lm
 209043 € 3,50



174402

Madame

Rosone in metallo verniciato opaco bianco o nero. Cavo in tessuto. Diffusore con telaio metallico avvolto da nastro in tessuto di raso bianco, canvas o nero.



219875

174396

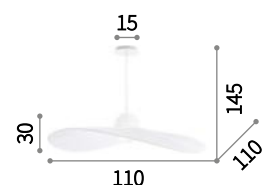

⏏ (E) IP20

2,600 Kg / 0,2012 m³
E27 max 1 x 60W

174396 ■ € 304
219875 ■ € 304
174402 ■ € 304

💡 3000 K / 720 Lm
101354 € 9,00



Basket

Montatura in metallo cromato. Diffusore in spago ignifugo. Sospensione a sfera con cavo in acciaio regolabile in lunghezza da dispositivo automatico.

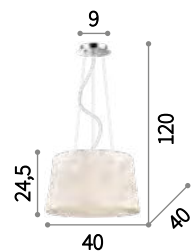

IP20

1,200 Kg / 0,0555 m³
E27 max 3 x 60W

082509 € 150

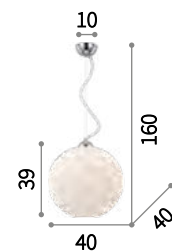

IP20

0,800 Kg / 0,0911 m³
E27 max 1 x 60W

096162 € 120

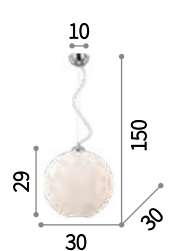

IP20

0,500 Kg / 0,0417 m³
E27 max 1 x 60W

096100 € 85

3000 K / 720 Lm
123899 € 6,90

3000 K / 720 Lm
123899 € 6,90

3000 K / 720 Lm
123899 € 6,90





London

Montatura in metallo cromato. Paralume in lamina di PVC cromata e semi trasparente. Per la sospensione, cavi in acciaio a lunghezza regolabile con dispositivi ferma cavo automatici.

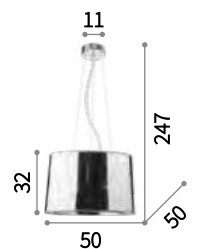

IP20

2,950 Kg / 0,1055 m³
E27 max 5 x 60W
032351 € 178

3000 K / 860 Lm
119571 € 6,50



P. 275



P. 305



Nordik

Montatura in metallo verniciato nero opaco. Paralume in lamina di PVC dorato rivestito in tessuto nero.



IP20

1,760 Kg / 0,1694 m³
E27 max 6 x 60W

161662 ■ € 215

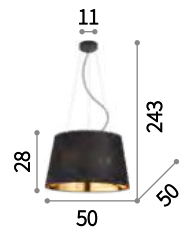

IP20

1,500 Kg / 0,1064 m³
E27 max 4 x 60W

161648 ■ € 157

3000 K / 860 Lm
101347 € 8,90

3000 K / 860 Lm
101347 € 8,90



P. 206

P. 271

P. 294



Foil

Rosone in materiale plastico. Cavo in tessuto. Paralume in lamina di pvc rifinito con effetto metallico.

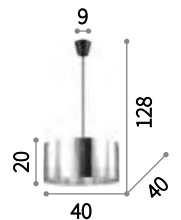

IP20

0,610 Kg / 0,0425 m³
E27 max 1 x 60W

168234 ■ € 98

3000 K / 720 Lm
101330 € 8,50

105628



103242



Woody

Montatura in metallo cromato. Diffusore in PVC o in tessuto, chiuso sul fondo da vetro trasparente acidato. Sospensioni con cavi regolabili in lunghezza.



087719

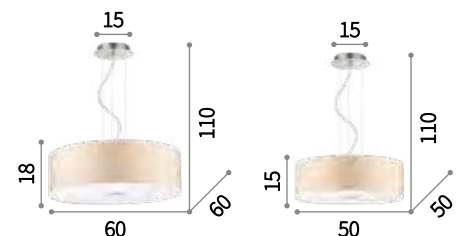

IP20

6,150 Kg / 0,1352 m³
E27 max 5 x 60W

103242 € 195
087719 € 195
105628 € 195

IP20

4,000 Kg / 0,0832 m³
E27 max 4 x 60W

122236 € 155
087702 € 155
122243 € 155



P. 164



P. 212



P. 272



P. 296



3000 K / 720 Lm
123899 € 6,90



3000 K / 720 Lm
123899 € 6,90



Hilton

Montatura in cromo. Paralume in lamina di PVC rivestita in tessuto. Sul fondo, diffusore in vetro trasparente sabbiato. Sospensioni con cavi a lunghezza regolabile.

 Lampadine alogene G9 28W 2700 K incluse nel modello 075495.

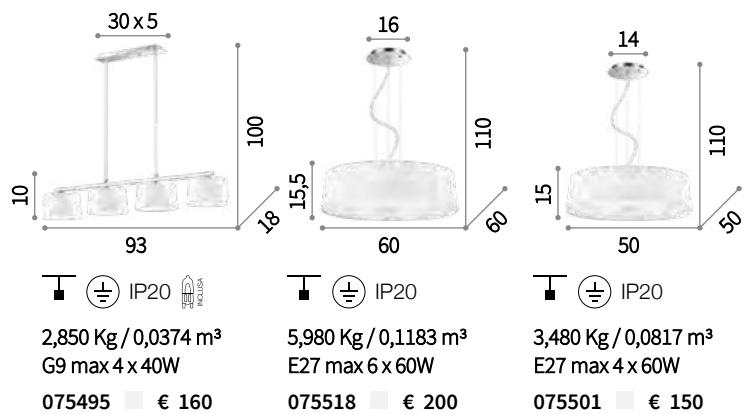

P. 212 P. 272 P. 296

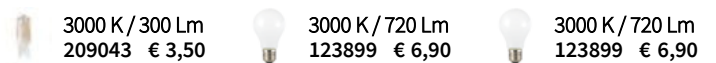

3000 K / 300 Lm
209043 € 3,50

3000 K / 720 Lm
123899 € 6,90

3000 K / 720 Lm
123899 € 6,90



Isa

Montatura in metallo cromato. Paralumi in lamina di pvc trasparente avvolto da nastri in tessuto leggero di colore bianco. Diffusore in vetro trasparente sabbato.

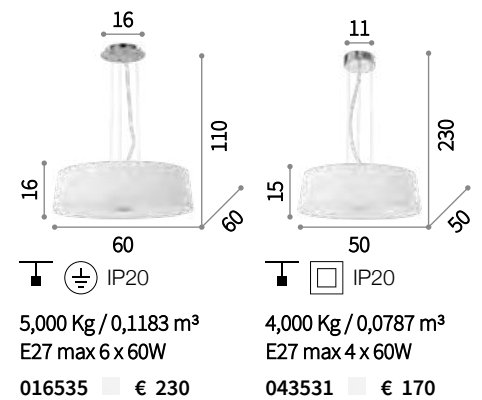

IP20

IP20

5,000 Kg / 0,1183 m³
E27 max 6 x 60W

4,000 Kg / 0,0787 m³
E27 max 4 x 60W

016535 € 230

043531 € 170



P. 273 P. 297

3000 K / 720 Lm
123899 € 6,90

3000 K / 720 Lm
123899 € 6,90



Wheel

Montatura circolare in metallo smaltato. Paralume in lamina di PVC rivestita di tessuto. Cavi in acciaio a lunghezza regolabile con dispositivi ferma cavo automatici.

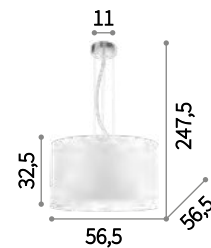

■ □ IP20

2,810 Kg / 0,1412 m³
E27 max 5 x 60W

009698 ■ € 195

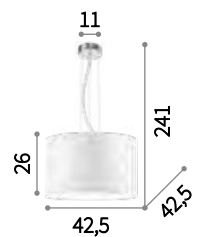

■ □ IP20

2,020 Kg / 0,0614 m³
E27 max 3 x 60W

009681 ■ € 100



P. 165

💡 3000 K / 720 Lm
123899 € 6,90

💡 3000 K / 720 Lm
123899 € 6,90



Sheraton

Montatura in metallo cromato. Paralumi in lamina di PVC rivestita di tessuto.

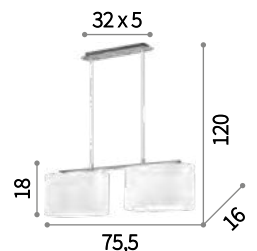

⏏ Ⓢ IP20

2,490 Kg / 0,0381 m³
E14 max 4 x 40W

074962 € 135



P. 210 P. 273 P. 297

💡 3000 K / 360 Lm
101217 € 3,00



141909

Multiflex

Montatura in metallo rifinito con vernice opaca. Bracci flessibili rivestiti di gomma. Cavo in acciaio regolabile in lunghezza da dispositivo automatico.



141893

141916

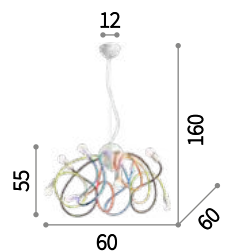

IP20

4,440 Kg / 0,0656 m³
E14 max 8 x 40W

141893 € 304
141909 € 304
141916 € 302

3000 K / 360 Lm
101217 € 3,00



P. 167 P. 213



Dream Big

Rosone in metallo verniciato bianco opaco. Cavo in tessuto. Diffusore in vetro soffiato bianco acidato. Cesto in corda.

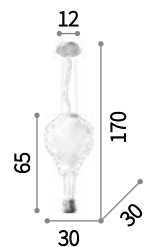

IP20

2,420 Kg / 0,1013 m³
E27 max 1x42W

179858 € 116

3000 K / 720 Lm
123899 € 6,90



Avion

Corpo luce e rosone in legno dipinto con vernice opaca. Dettagli in metallo cromato. Diffusori in vetro soffiato bianco acidato.

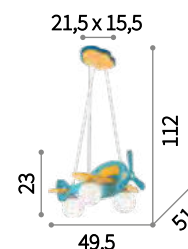

IP20

2,440 Kg / 0,0618 m³
E14 max 3 x 40W

136325 € 140

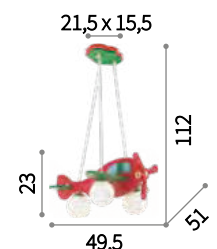

IP20

2,440 Kg / 0,0618 m³
E14 max 3 x 40W

136318 € 140

3000 K / 360 Lm
101217 € 3,00

3000 K / 360 Lm
101217 € 3,00

Moderno

Lampade da soffitto



Nodi 136



Nodino 138



Nodi Crystal 139



Leaves 140



Corallo 140



Pauline 141



Vortex 141



Neve 144



Moonlight 146



Royal 147



Quadro 148



Admiral 149



Roma 150



King 151



Audi-61 153



Compo 154



Almond 156



Daisy 157



Smarties 158



Glory 159



Arizona 160



Mapa 162



Lana 163



Phoenix 163



Woody 164



Wheel 165



Ritz 165



Titti 166



Mallow 170



Pon Pon 170



Cross 171



Mikado 171

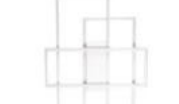

Frame 172



Karol 173



Flat 174



Esil 176

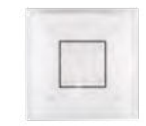

Steno 176



Mito 177



Totem 177



Ali 178



Dony 178



Geko 179



Toffee 181



Simply 181



Logos 182



Lunare 182



Oby 183



Petit 184



Alfa 185



Snake 187



Ciak 188



Movie 188



Dynamite 189



Dea 142



Rain 143



Giada 143



Virgin 152



Orion 152



Calypso 153



Ulisse 160



Candy 161



Ovalino 162



Multiflex 167



Octopus 168

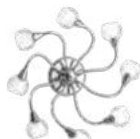

Tender 169



Celine 174



Iris 175



Ocean 175



Gemma 179



Save 180



Ring 180



Slem 186



Elis 186



Nostalgia 187

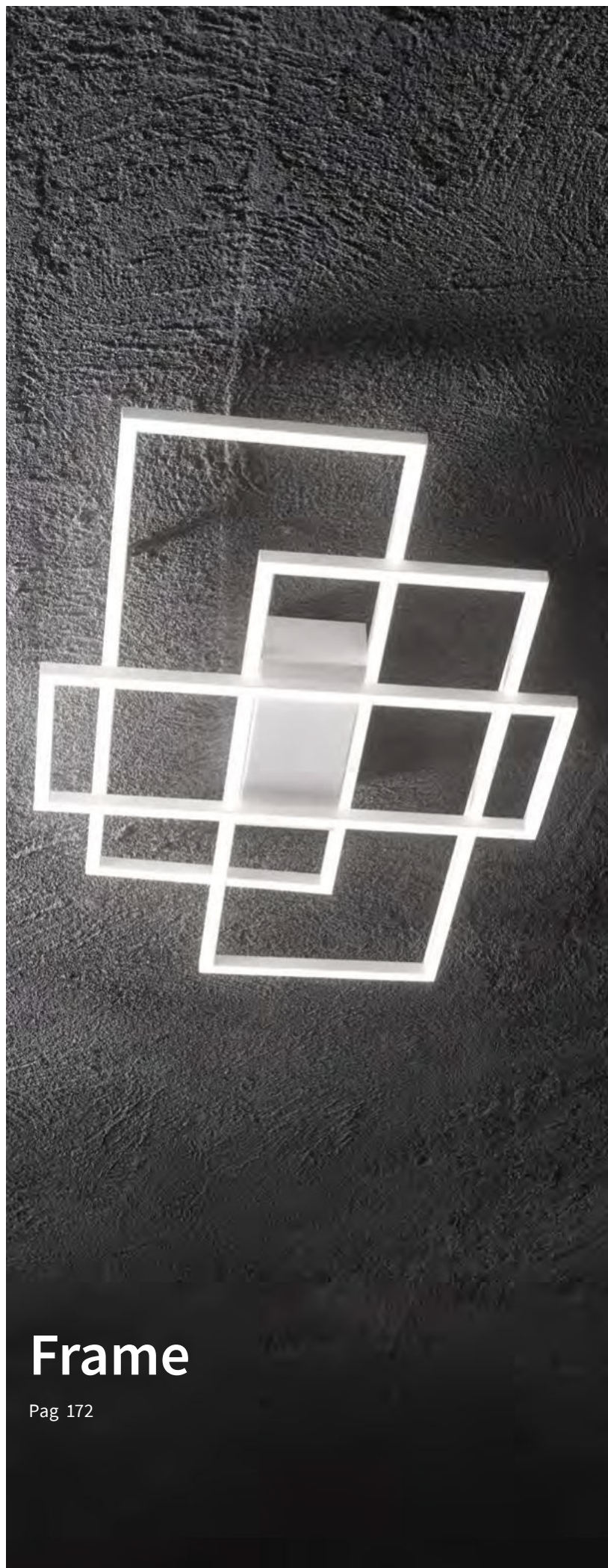

Frame

Pag 172



200484



073712

Nodi **new**

Montatura in metallo cromato oppure in ottone satinato. Elementi di giunzione ruotabili per una disposizione personalizzata. Diffusori in vetro bianco soffiato, acidato o trasparente e cromato.

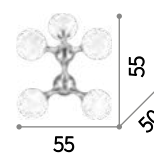

■ ⊕ IP20

3,200 Kg / 0,1012 m³
E14 max 5 x 40W

073712 ■ € 157
241050 ■ € 157 **new**
200484 ■ € 283

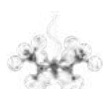

P. 026



P. 192



3000 K / 430 Lm
101200 € 2,90



241050

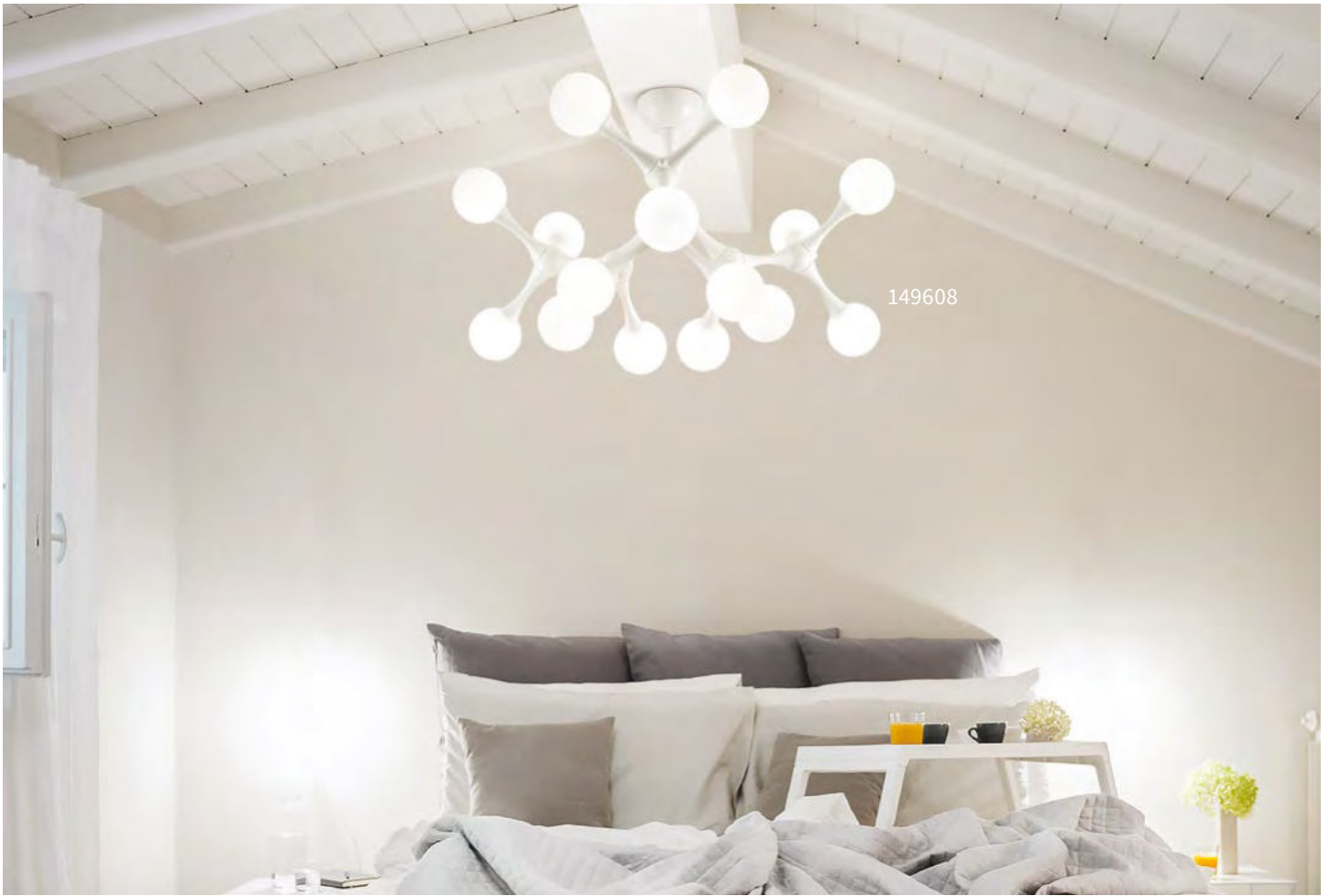

149608

Nodino

Montatura in metallo con finitura in cromo o in vernice opaca bianca. Diffusori in vetro bianco soffiato e acidato.

LED Lampadine LED G9 3,2W 3000 K incluse. Cod. 209043



133386

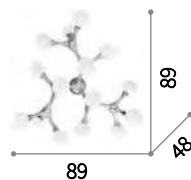

IP20

4,390 Kg / 0,5036 m³
G9 max 15 x 15W

149608 € 596
133409 € 645

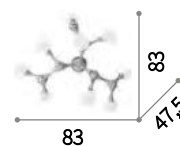

IP20

3,160 Kg / 0,3975 m³
G9 max 9 x 15W

149622 € 418
133393 € 460

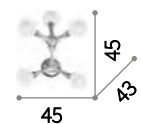

IP20

1,620 Kg / 0,0897 m³
G9 max 5 x 15W

149615 € 207
133386 € 226

3000 K / 300 Lm
209043 € 3,50

3000 K / 300 Lm
209043 € 3,50

3000 K / 300 Lm
209043 € 3,50



Nodi Crystal

Montatura in metallo cromato. Diffusori composti da anelli in metallo cromato con ottagononi di cristallo incastonati all'interno.

 Lampadine alogene G9 28W 2700 K incluse.

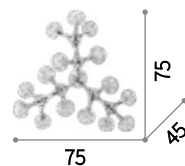

 IP20 

5,000 Kg / 0,2422 m³
G9 max 15 x 40W

093512  € 750

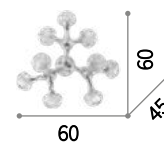

 IP20 

3,400 Kg / 0,1012 m³
G9 max 9 x 40W

093505  € 430

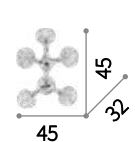



 IP20 

1,800 Kg / 0,0940 m³
G9 max 5 x 40W

098043  € 280

 3000 K / 300 Lm
209043 € 3,50

 3000 K / 300 Lm
209043 € 3,50

 3000 K / 300 Lm
209043 € 3,50

Leaves

Montatura in metallo bianco. Elementi decorativi in vetro soffiato bianco modellato a mano.

 Lampadine alogene G9 28W 2700 K incluse.

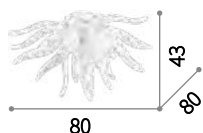

 IP20

2,000 Kg / 0,0571 m³
G9 max 6x40W

112299 € 380



 3000 K / 300 Lm
209043 € 3,50



P. 028

Corallo

Montatura a sfera e dettagli in metallo cromato. Elementi decorativi in vetro bianco lavorato a mano.

 Lampadine LED G9 3,2W 3000 K incluse. Cod. 209043

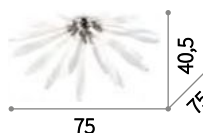

 IP20

4,100 Kg / 0,0459 m³
G9 max 6x40W

074627 € 338



 3000 K / 300 Lm
209043 € 3,50



P. 029



P. 192

Pauline

Montatura in metallo cromato. Elementi decorativi in vetro soffiato e modellato a mano.

 Lampadine alogene G9 28W 2700 K incluse.

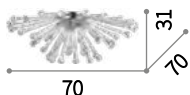

 IP20

3,500 Kg / 0,0380 m³
G9 max 5 x 40W

111117 ■ € 367

 3000 K / 300 Lm
209043 ■ € 3,50



P. 030

Vortex

Montatura in metallo verniciato bianco opaco. Elementi decorativi in metallo modellato artigianalmente e dipinti a mano con argento.

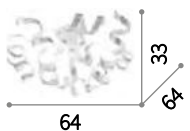

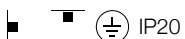
 IP20

1,900 Kg / 0,1135 m³
E14 max 5 x 40W

101590 ■ € 147

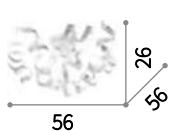

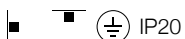
 IP20

1,500 Kg / 0,0878 m³
E14 max 3 x 40W

101576 ■ € 118

 3000 K / 430 Lm
101200 ■ € 2,90

 3000 K / 430 Lm
101200 ■ € 2,90



P. 031



Dea

Montatura a sfera e copri portalampane in metallo cromato.

LED

Lampadine LED E27 2W Globo D125
trasparente 3000 K incluse.
Cod. 184470

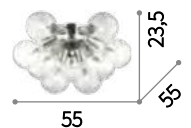

3,300 Kg / 0,0777 m³
E27 max 10 x 20W
074740 € 260



P. 033



3000 K / 860 Lm
101347 € 8,90

Rain

Montatura in metallo cromato. Pendagli con elementi in cristallo colorato e molato in varie forme e gocce finali.

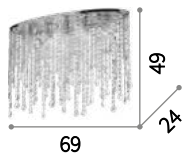

■ IP20

3,820 Kg / 0,0225 m³
E14 max 5 x 40W

008455 € 274
105239 € 278

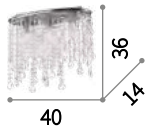

■ IP20

1,800 Kg / 0,0094 m³
E14 max 3 x 40W

008370 € 132



3000 K / 430 Lm
101224 € 2,90

3000 K / 430 Lm
101224 € 2,90



P. 038



P. 193



P. 262



P. 292



105239

Giada

Montatura in metallo cromato. Pendagli con elementi ottagonali e puntali finali in cristallo molato. Sospensioni con cavi in acciaio a lunghezza regolabile.

LED Lampadine LED G9 3,2W 3000 K
includ. Cod. 209043

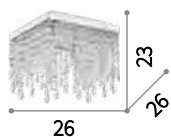

■ IP20

2,530 Kg / 0,0078 m³
G9 max 4 x 40W

098777 € 195



3000 K / 300 Lm
209043 € 3,50



P. 143



P. 193





Neve

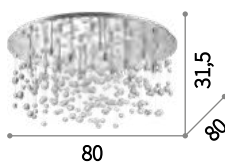

Montatura in metallo. Elementi decorativi con sfere di vetro fissate a fili di nylon. Disponibile con montatura cromata e sfere trasparenti o con montatura in bianco opaco e sfere bianche e trasparenti.

 Lampadine alogene G9 28W 2700 K incluse.

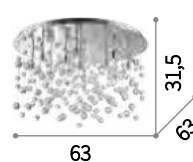

■  IP20 
 11,250 Kg / 0,1524 m³
 G9 max 15 x 40W
 101194 € 600
 030784 € 540



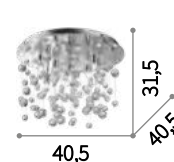

■  IP20 
 7,420 Kg / 0,0920 m³
 G9 max 12 x 40W
 101187 € 430
 022239 € 380

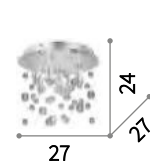

■  IP20 
 3,590 Kg / 0,0344 m³
 G9 max 8 x 40W
 101170 € 250
 022222 € 215



■  IP20 
 1,500 Kg / 0,0149 m³
 G9 max 5 x 40W
 094687 € 115





P. 194



P. 263

 3000 K / 300 Lm
 209043 € 3,50

 3000 K / 300 Lm
 209043 € 3,50

 3000 K / 300 Lm
 209043 € 3,50

 3000 K / 300 Lm
 209043 € 3,50

022239





082790

Moonlight

Montatura in metallo con finitura disponibile in cromo o dorato. Pendagli con ottagoni e sfere in cristallo molato.



Lampadine alogene G9 28W
2700 K incluse.



077802

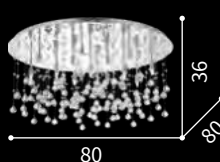

11,800 Kg / 0,1524 m³
G9 max 15 x 40W

077819 € 665
082790 € 720

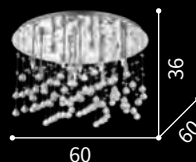

6,000 Kg / 0,0933 m³
G9 max 12 x 40W

077802 € 456
082783 € 492

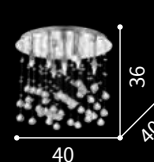

2,900 Kg / 0,0398 m³
G9 max 8 x 40W

077796 € 258
080932 € 272

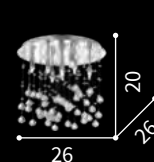

1,500 Kg / 0,0144 m³
G9 max 5 x 40W

094649 € 127
094663 € 135



P. 195

3000 K / 300 Lm
209043 € 3,50

3000 K / 300 Lm
209043 € 3,50

3000 K / 300 Lm
209043 € 3,50

3000 K / 300 Lm
209043 € 3,50



Royal

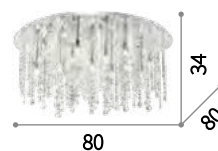

Montatura circolare e portalampane in metallo cromato. Pendagli con elementi in cristallo molato ottagonali, quadrati, rettangolari e gocce finali.

 Lampadine alogene G9 28W 2700 K incluse.



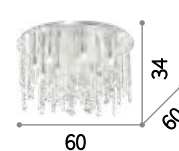

■  IP20 
 9,830 Kg / 0,1491 m³
 G9 max 15 x 40W
 053011  € 670

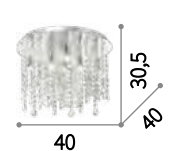

■  IP20 
 5,900 Kg / 0,0881 m³
 G9 max 12 x 40W
 053004  € 480





■  IP20 
 2,840 Kg / 0,0379 m³
 G9 max 8 x 40W
 052991  € 250



P. 262

 3000 K / 300 Lm
 209043 € 3,50

 3000 K / 300 Lm
 209043 € 3,50

 3000 K / 300 Lm
 209043 € 3,50



Quadro

Base quadrata ed elementi porta lampade in metallo cromato. Corpo luce cubico con facciate di reticolo a maglia larga con spessore di 2,5 mm in fusione d'alluminio.



Lampadine alogene G9 28W 2700 K incluse.

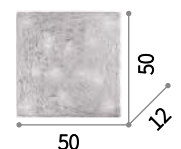
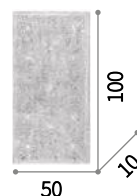

9,900 Kg / 0,1097 m³
G9 max 11 x 40W
036045 ■ € 562

13,750 Kg / 0,1309 m³
G9 max 12 x 40W
031651 ■ € 665

6,840 Kg / 0,0564 m³
G9 max 8 x 40W
031668 ■ € 405

3000 K / 300 Lm
209043 € 3,50

3000 K / 300 Lm
209043 € 3,50

3000 K / 300 Lm
209043 € 3,50



Admiral

Diffusore composto da anelli in metallo saldati tra loro e da elementi in cristallo molato incastonati all'interno.

 Lampadine alogene G9 28W 2700 K incluse.

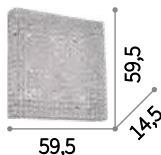

8,490 Kg / 0,1000 m³
G9 max 10 x 40W

080291 € 677

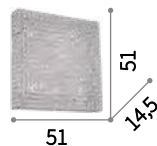

7,050 Kg / 0,0719 m³
G9 max 8 x 40W

080352 € 546

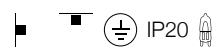
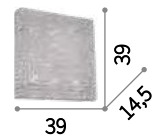

4,580 Kg / 0,0444 m³
G9 max 6 x 40W

080345 € 364

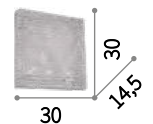



3,000 Kg / 0,0303 m³
G9 max 4 x 40W

080338 € 250



P. 195

 3000 K / 300 Lm
209043 € 3,50

 3000 K / 300 Lm
209043 € 3,50

 3000 K / 300 Lm
209043 € 3,50

 3000 K / 300 Lm
209043 € 3,50



Roma

Montatura e dettagli in metallo cromato.
Diffusore con elementi quadrati in
cristallo molato sulla fascia laterale e
vetro sabbato sul fondo.

 Lampadine alogene G9 28W
2700 K incluse.

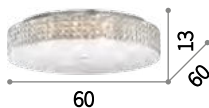

9,600 Kg / 0,1202 m³
G9 max 12 x 40W
087870 € 456



6,800 Kg / 0,0905 m³
G9 max 9 x 40W
087863 € 403

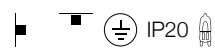
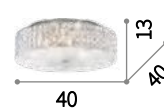

4,800 Kg / 0,0588 m³
G9 max 6 x 40W
000657 € 285

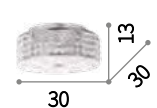

2,500 Kg / 0,0390 m³
G9 max 4 x 40W
093093 € 194



P. 041





P. 196



P. 263

 3000 K / 300 Lm
209043 € 3,50

 3000 K / 300 Lm
209043 € 3,50

 3000 K / 300 Lm
209043 € 3,50

 3000 K / 300 Lm
209043 € 3,50



King

Diffusore composto da anelli in metallo cromato o dorato con ottagononi di cristallo incastonati all'interno.

 Lampadine alogene G9 28W 2700 K incluse.



073262

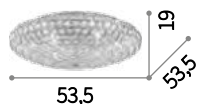

6,250 Kg / 0,0946 m³
G9 max 9 x 40W

073255 € 460
073262 € 500

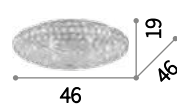

4,750 Kg / 0,0729 m³
G9 max 7 x 40W

073224 € 350

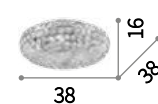

3,200 Kg / 0,0487 m³
G9 max 5 x 40W

075419 € 270
073187 € 280

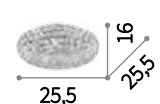



1,750 Kg / 0,0240 m³
G9 max 3 x 40W

075389 € 150
075402 € 170



P. 042

 3000 K / 300 Lm
209043 € 3,50

 3000 K / 300 Lm
209043 € 3,50

 3000 K / 300 Lm
209043 € 3,50

 3000 K / 300 Lm
209043 € 3,50

Virgin

Montatura in metallo cromato. Elementi decorativi di cristallo molato in forma di perle e quadrati di varie misure.

 Lampadine alogene G9 28W 2700 K incluse.

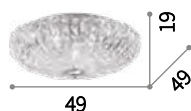

6,100 Kg / 0,0721 m³
G9 max 6 x 40W

016122 € 458



3,700 Kg / 0,0470 m³
G9 max 5 x 40W

018089 € 330

 3000 K / 300 Lm
209043 € 3,50

 3000 K / 300 Lm
209043 € 3,50



P. 043



Orion

Diffusore composto da anelli in metallo cromato con ottagoni di cristallo incastonati all'interno.

 Lampadine alogene G9 28W 2700 K incluse.

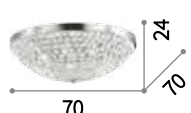

9,500 Kg / 0,1879 m³
G9 max 12 x 40W

059129 € 685



5,000 Kg / 0,0924 m³
G9 max 7 x 40W

059150 € 360

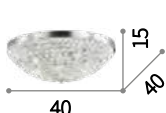

3,250 Kg / 0,0451 m³
G9 max 5 x 40W

059143 € 213

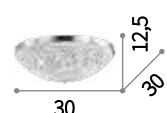



1,950 Kg / 0,0282 m³
G9 max 3 x 40W

059136 € 114

 3000 K / 300 Lm
209043 € 3,50

 3000 K / 300 Lm
209043 € 3,50

 3000 K / 300 Lm
209043 € 3,50

 3000 K / 300 Lm
209043 € 3,50



P. 044



P. 196

Calypso

Montatura in metallo cromato. Elementi decorativi in cristallo molato.



IP20

6,600 Kg / 0,0816 m³
E14 max 8 x 40W

066424 € 435



IP20

3,200 Kg / 0,0350 m³
E14 max 4 x 40W

066400 € 264



3000 K / 430 Lm
101200 € 2,90

3000 K / 430 Lm
101200 € 2,90



P. 045 P. 197

Audi-61

Montatura in metallo cromato. Catene di ottagononi in cristallo. Diffusore in vetro soffiato.

Lampadine alogene G9 28W
2700 K incluse.



IP20

7,410 Kg / 0,1124 m³
G9 max 8 x 40W

133904 € 450

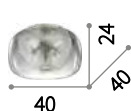

IP20

4,950 Kg / 0,0719 m³
G9 max 6 x 40W

133898 € 292



3000 K / 300 Lm
209043 € 3,50

3000 K / 300 Lm
209043 € 3,50



P. 048 P. 197



Compo

Montatura in metallo cromato o verniciato bianco opaco. Elementi diffusori in vetro soffiato bianco incamiciato e acidato o trasparente fumè.

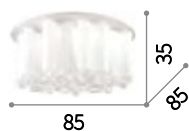

■ ⊕ IP20

25,620 Kg / 0,5084 m³
E27 max 15 x 60W

125565 € 1.150



■ ⊕ IP20

17,200 Kg / 0,3008 m³
E27 max 10 x 60W

125510 € 832
172804 € 904

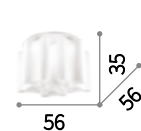

■ ⊕ IP20

9,900 Kg / 0,1918 m³
E27 max 6 x 60W

125503 € 433
172828 € 503



3000 K / 860 Lm
119571 € 6,50



3000 K / 860 Lm
119571 € 6,50



3000 K / 860 Lm
119571 € 6,50



P. 078

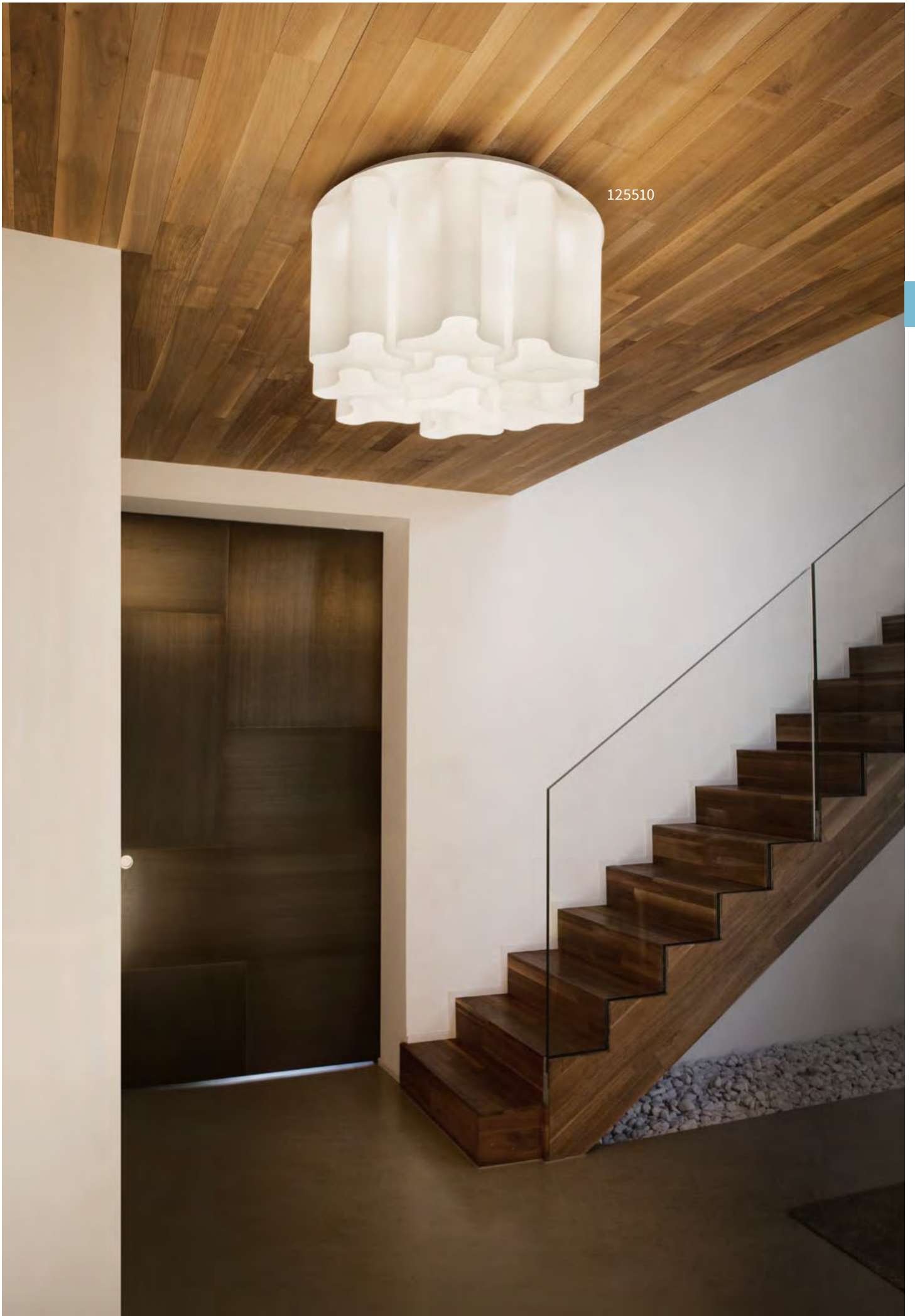

125510



Almond

Montatura in metallo verniciato bianco opaco. Elementi diffusori in vetro soffiato bianco incamiciato e acidato.

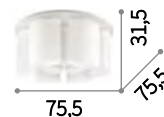

■ ⊕ IP20

26,390 Kg / 0,3100 m³
E27 max 9 x 60W

159645 ■ € 552

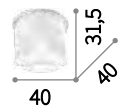

■ ⊕ IP20

7,610 Kg / 0,1048 m³
E27 max 3 x 60W

159638 ■ € 262

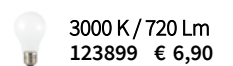
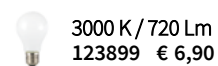



Daisy **new**

Base in metallo rifinita con foglia oro.
Diffusori in vetro soffiato bianco, acidato e
con rigatura in rilievo.

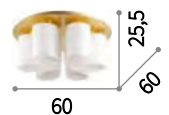

■ □ IP20

12,000 Kg / 0,1183 m³
E27 max 6x60W

247779 ■ € 360 **new**

💡 3000 K / 720 Lm
123899 € 6,90



Smarties

Montatura in metallo. Diffusore in vetro bianco soffiato e acidato oppure trasparente e sabbiato nella zona centrale.

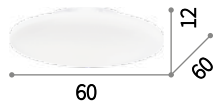

4,690 Kg / 0,1480 m³
E27 max 3x60W

032023 € 220

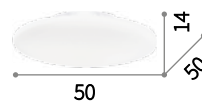

3,030 Kg / 0,1009 m³
E27 max 3x60W

035512 € 203
032030 € 152

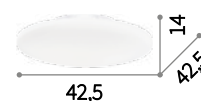

2,810 Kg / 0,0599 m³
E27 max 2x60W

035536 € 170
032047 € 136

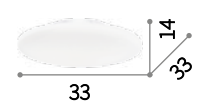

1,790 Kg / 0,0454 m³
E27 max 1x60W

035543 € 116
009223 € 88



P. 090 P. 203 P. 265

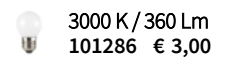
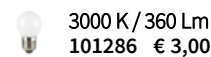
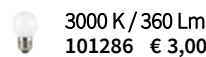
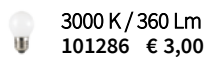



Glory

Montatura rifinita in nickel satinato.
Diffusore in vetro bianco soffiato e acidato.

LED Lampadine LED G9 3,2W 3000 K
incluse nel modello 101149.
Cod. 209043

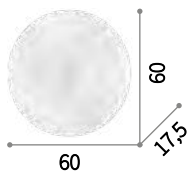

■ ■ ⊕ IP20
4,810 Kg / 0,1789 m³
E27 max 5 x 60W
019765 € 290

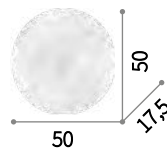

■ ■ ⊕ IP20
3,410 Kg / 0,0744 m³
E27 max 3 x 60W
019758 € 165

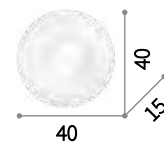

■ ■ ⊕ IP20
2,100 Kg / 0,0700 m³
E27 max 2 x 60W
101132 € 150

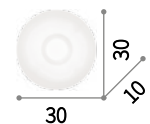



■ ■ ⊕ ⚠ IP20 
1,200 Kg / 0,0309 m³
G9 max 1 x 40W
101149 € 83



P. 091

 3000 K / 360 Lm
101286 € 3,00

 3000 K / 360 Lm
101286 € 3,00

 3000 K / 360 Lm
101286 € 3,00

 3000 K / 300 Lm
209043 € 3,50

Arizona

Montatura in metallo rifinito in ottone satinato. Diffusore in vetro bianco soffiato, acidato e con rigature decorative in rilievo.

LED Lampadine LED GX53 9,5W 3000 K include. Cod. 123936

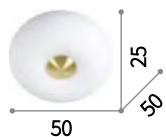

IP20

7,680 Kg / 0,1299 m³
GX53 max 5 x 15W

214511 € 400

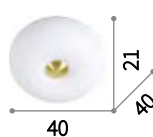

IP20

3,050 Kg / 0,0744 m³
GX53 max 3 x 15W

214504 € 260

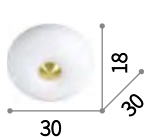

IP20

2,960 Kg / 0,0452 m³
GX53 max 2 x 15W

214498 € 182

3000 K / 760 Lm
123936 € 5,90

3000 K / 760 Lm
123936 € 5,90

3000 K / 760 Lm
123936 € 5,90



P. 093

Ulisse

Montatura in metallo verniciato bianco opaco. Diffusore in vetro bianco soffiato e acidato.

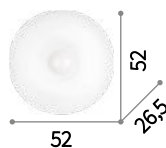

IP20

4,750 Kg / 0,1218 m³
E27 max 3 x 60W

098586 € 216

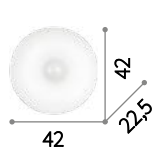

IP20

2,290 Kg / 0,0720 m³
E27 max 3 x 60W

095196 € 138



3000 K / 860 Lm
119571 € 6,50

3000 K / 860 Lm
119571 € 6,50



P. 093



Candy

Montatura in metallo con finitura nickel satinato. Diffusore in vetro bianco soffiato e acidato.

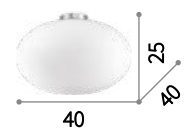

IP20

2,500 Kg / 0,0799 m³
E27 max 1 x 60W

086781 € 160



P. 092

P. 265

3000 K / 720 Lm
123899 € 6,90

Ovalino

Diffusore composto da elementi circolari in lastra di vetro curvata e acidata.

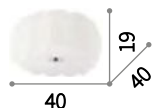
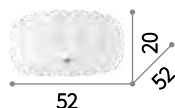

■  IP20

■  IP20

7,700 Kg / 0,1448 m³
E27 max 8 x 60W

5,100 Kg / 0,1202 m³
E27 max 5 x 60W

094014 ■ € 240

093963 ■ € 190

 3000 K / 720 Lm
123899 € 6,90

 3000 K / 720 Lm
123899 € 6,90



P. 095 P. 203

Mapa

Montatura in metallo. Diffusore a sfera in vetro bianco soffiato e acidato.

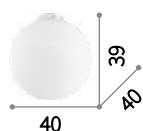

■  IP20

2,590 Kg / 0,1290 m³
E27 max 1 x 60W

059839 ■ € 153

 3000 K / 860 Lm
119571 € 6,50

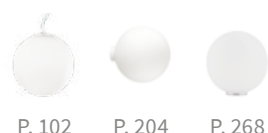

P. 102 P. 204 P. 268

Lana

Diffusore in vetro trasparente con decorazioni serigrafate all'interno e sabbiate all'esterno. Ganci ferma vetro in metallo cromato.

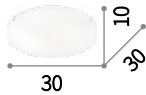
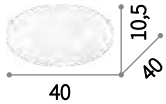

1,500 Kg / 0,0279 m³
E27 max 3 x 60W

068145 € 52



0,800 Kg / 0,0168 m³
E27 max 2 x 60W

068138 € 35

 3000 K / 360 Lm
101286 € 3,00

 3000 K / 360 Lm
101286 € 3,00



P. 088

P. 202

Phoenix

Montatura in metallo cromato. Paralume con telaio in metallo e rivestimento in tessuto. Elementi decorativi con catene di ottagoni in cristallo molato.

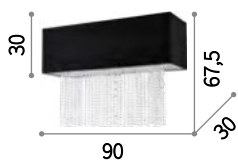

6,800 Kg / 0,1074 m³
E27 max 5 x 60W

099118 € 474

101156 € 474

099118



 3000 K / 720 Lm
123899 € 6,90



P. 119



P. 205



P. 293



101156



122205

122212

Woody

Montatura in metallo cromato. Diffusore in PVC o in tessuto, chiuso sul fondo da vetro trasparente acidato.



090863

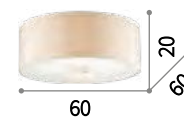

6,000 Kg / 0,1352 m³
E27 max 5 x 60W

122205 € 195
090863 € 195
122212 € 195

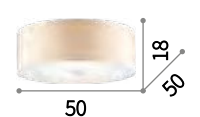

3,800 Kg / 0,0908 m³
E27 max 4 x 60W

103266 € 145
090900 € 145
103273 € 145



P. 126



P. 212



P. 272



P. 296



3000 K / 720 Lm
123899 € 6,90



3000 K / 720 Lm
123899 € 6,90

Wheel

Montatura circolare in metallo smaltato.
Paralume in lamina di PVC rivestita di tessuto.

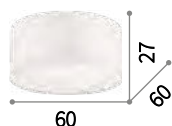

■ IP20
3,890 Kg / 0,1270 m³
E27 max 5 x 60W
036021 € 195

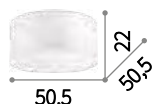

■ IP20
2,280 Kg / 0,0758 m³
E27 max 3 x 60W
036014 € 100

3000 K / 720 Lm
123899 € 6,90

3000 K / 720 Lm
123899 € 6,90



P. 129



Ritz

Base in metallo smaltato. Paralume e pannello diffusore inferiore in lamina di PVC rivestita di tessuto.

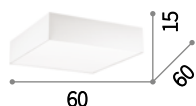

■ IP20
1,710 Kg / 0,0968 m³
E27 max 4 x 60W
152912 € 188

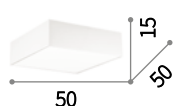

■ IP20
1,480 Kg / 0,0700 m³
E27 max 4 x 60W
152899 € 150

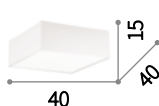

■ IP20
1,110 Kg / 0,0444 m³
E27 max 4 x 52W
152875 € 116

3000 K / 720 Lm
123899 € 6,90

3000 K / 720 Lm
123899 € 6,90

3000 K / 720 Lm
123899 € 6,90





Titti

Montatura in metallo con elementi in legno naturale. Diffusori in metallo. Rifinito con vernice lucida.



■ ⊕ IP20

3,060 Kg / 0,0459 m³
E27 max 6 x 60W

157160 € 152

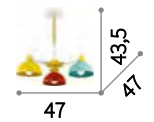

■ ⊕ IP20

1,650 Kg / 0,0268 m³
E27 max 3 x 60W

157146 € 86

💡 3000 K / 720 Lm
123899 € 6,90

💡 3000 K / 720 Lm
123899 € 6,90



Multiflex

Montatura in metallo rifinito con vernice opaca. Bracci flessibili rivestiti di gomma.

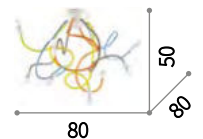

■ ⊕ IP20

4,330 Kg / 0,0353 m³
E14 max 8 x 40W

159010 ■ € 293



P. 131 P. 213

3000 K / 360 Lm
101217 € 3,00



Octopus

Base in metallo rifinito opaco. Bracci flessibili rivestiti di gomma di colore bianco, nero o multicolor. Diffusori in vetro trasparente soffiato e sabbato.

 Lampadine alogene G9 28W 2700 K incluse.

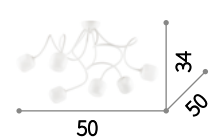
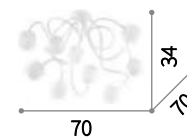



 IP20 

 IP20 

4,530 Kg / 0,0512 m³
G9 max 9 x 28W

3,000 Kg / 0,0390 m³
G9 max 6 x 28W

174990  € 360
175041  € 360
175010  € 360

174921  € 260
174976  € 260
174952  € 260

 3000 K / 300 Lm
209043 € 3,50

 3000 K / 300 Lm
209043 € 3,50



Tender

Montatura in cromo con bracci flessibili.
Diffusori trasparenti in vetro pirex soffiato
con parte interna smerigliata.

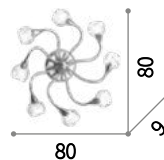

2,658 Kg / 0,0202 m³
E14 max 8 x 40W

004211 € 204

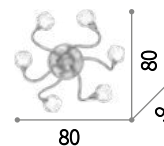

2,490 Kg / 0,0180 m³
E14 max 6 x 40W

028699 € 148

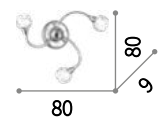



1,379 Kg / 0,0115 m³
E14 max 3 x 40W

028682 € 93



P. 213

 3000 K / 360 Lm
101217 € 3,00

 3000 K / 360 Lm
101217 € 3,00

 3000 K / 360 Lm
101217 € 3,00

Mallow

Base e bracci in metallo con finitura in vernice opaca bianca. Diffusori in vetro trasparente soffiato e sabbato.

 Lampadine alogene G9 28W 2700 K incluse.

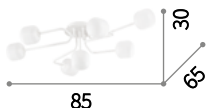

 IP20 

2,100 Kg / 0,0527 m³
G9 max 7 x 28W

174419 € 264

 3000 K / 300 Lm
209043 € 3,50



P. 308



Pon Pon

Montatura in metallo cromato modellato artigianalmente. Diffusori con bolle di vetro soffiato avvolte da filamento in alluminio.

 Lampadine LED G9 3,2W 3000 K incluse. Cod. 209043

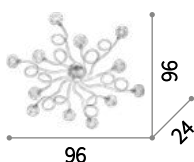

 IP20 

2,900 Kg / 0,0972 m³
G9 max 12 x 40W

074641 € 298

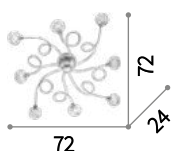

 IP20 

2,340 Kg / 0,0874 m³
G9 max 8 x 40W

074665 € 267

 3000 K / 300 Lm
209043 € 3,50

 3000 K / 300 Lm
209043 € 3,50



Cross

Montatura in metallo cromato con LED integrati su bacchette removibili per una rapida sostituzione.

LED Sorgente luminosa LED 3000 K, 20.000 h di durata.

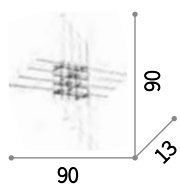

■ ■ □ IP20
2,170 Kg / 0,1390 m³
LED 38,4W / 2000 Lm
114767 ■ ■ € 435

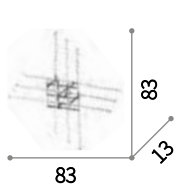

■ ■ □ IP20
1,650 Kg / 0,1074 m³
LED 28,8W / 1500 Lm
114750 ■ ■ € 365



Mikado

Montatura in metallo cromato. Diffusori in materiale acrilico satinato. Sorgente luminosa a led integrati.

LED Sorgente luminosa LED 3000 K, 20.000 h di durata.

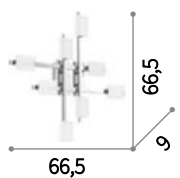

■ ■ □ IP20
2,850 Kg / 0,0551 m³
LED 56W / 4400 Lm
196657 ■ ■ € 400

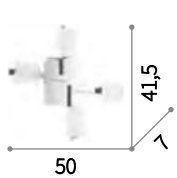

■ ■ □ IP20
1,600 Kg / 0,0222 m³
LED 28W / 2600 Lm
196640 ■ ■ € 240



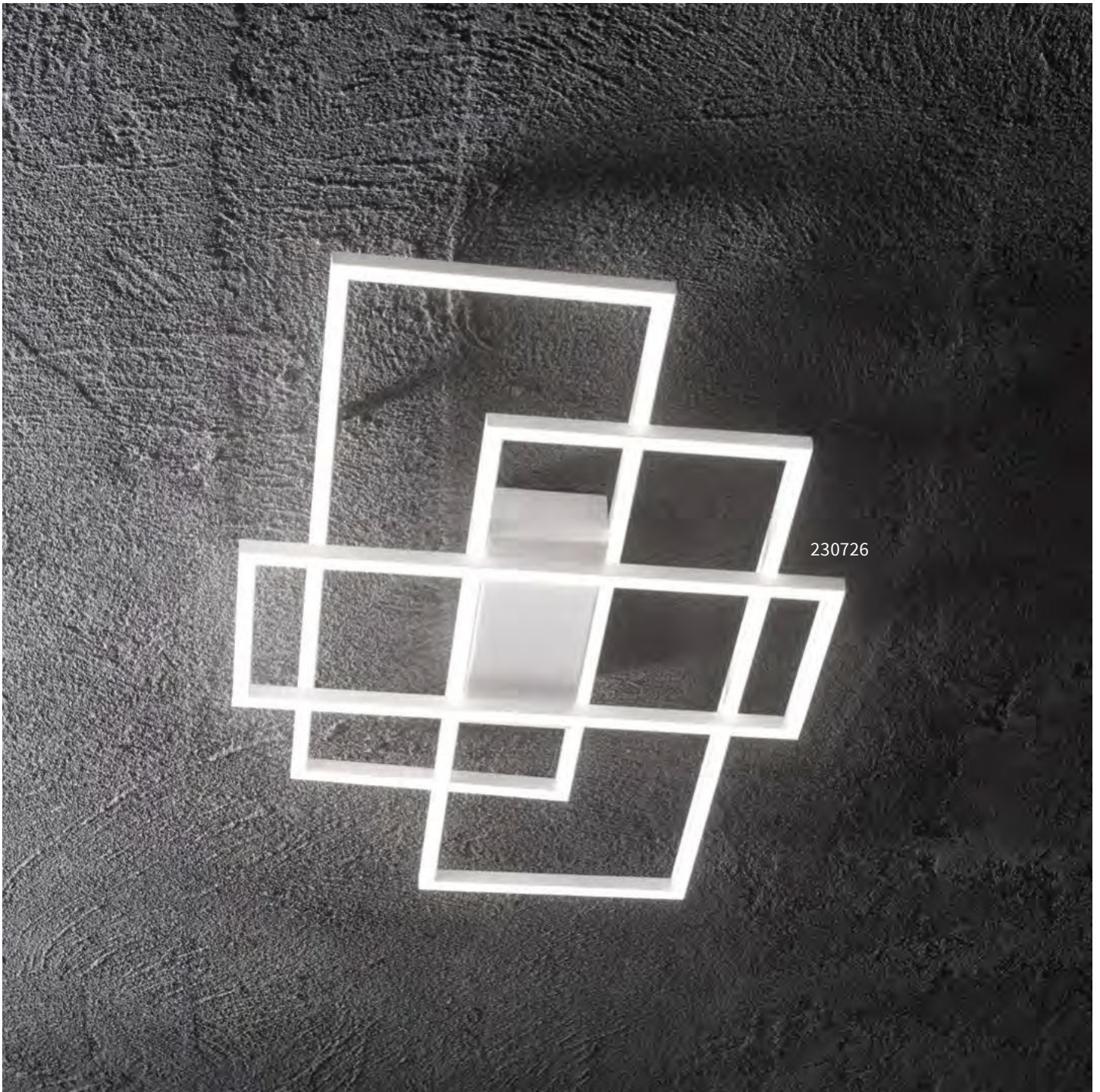

Frame **new**

Base e montatura in metallo verniciato bianco opaco. Diffusori in materiale plastico colore opale.

LED Sorgente luminosa LED 3000 K, 30.000 h di durata.

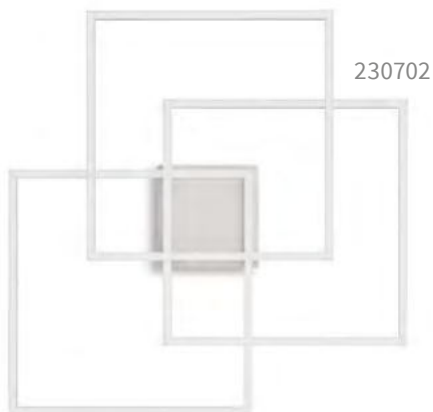

230702

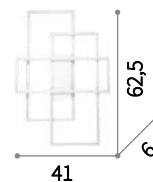

IP20

1,240 Kg / 0,0263 m³
LED 31W / 2200 Lm

230726 € 220 **new**

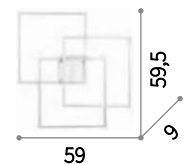

IP20

1,430 Kg / 0,0530 m³
LED 35W / 2800 Lm

230702 € 250 **new**



Karol **new**

Corpo luce in metallo verniciato bianco opaco. Diffusore in materiale plastico colore opale.

LED Sorgente luminosa LED 4000 K, 10.000 h di durata.

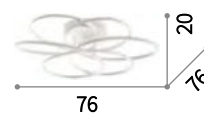

■ □ ⊕ IP20

3,430 Kg / 0,1185 m³
LED 63W / 8380 Lm

227832 ■ € 360 **new**

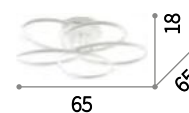

■ □ ⊕ IP20

2,300 Kg / 0,0901 m³
LED 45W / 6900 Lm



227825 ■ € 280 **new**

Flat

Montatura in metallo smaltato bianco opaco. Diffusore in lastra di acrilico satinato trasparente.

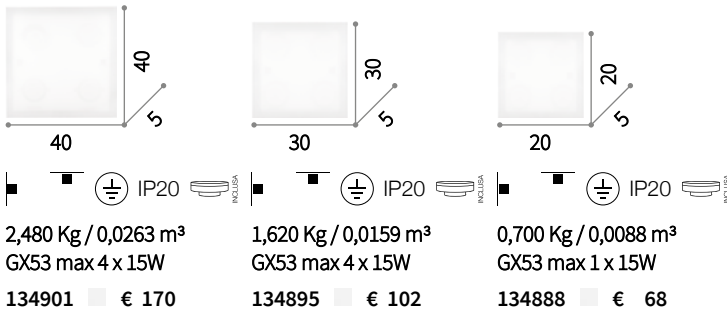
LED Lampadine LED GX53 9,5W 3000 K include. Cod. 123936





 3000 K / 760 Lm 123936 € 5,90
  3000 K / 760 Lm 123936 € 5,90
  3000 K / 760 Lm 123936 € 5,90

Celine

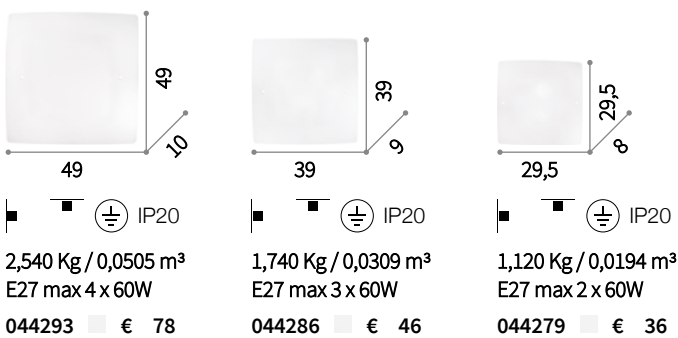
Base in metallo smaltato. Diffusore in vetro trasparente sabbaiato. Viti ferma vetro in metallo cromato.



 3000 K / 360 Lm 101286 € 3,00
  3000 K / 360 Lm 101286 € 3,00
  3000 K / 360 Lm 101286 € 3,00

Iris

Base in metallo cromato. Diffusore in vetro trasparente acidato.

LED Lampadine LED GX53 9,5W 3000 K include. Cod. 123936

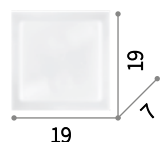
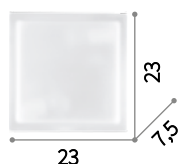

3,210 Kg / 0,0108 m³
GX53 max 1 x 15W

104546 € 97

2,240 Kg / 0,0081 m³
GX53 max 1 x 15W

104539 € 75

3000 K / 760 Lm
123936 € 5,90

3000 K / 760 Lm
123936 € 5,90

Ocean

Diffusore composto da due lastre di vetro: sotto con bordo a specchio e smerigliato al centro, sopra con decorazione serigrafata e applicazioni di bottoni in vetro.

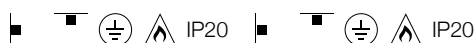
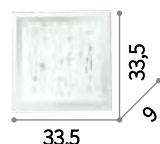
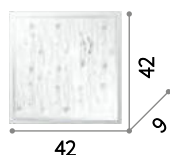

2,930 Kg / 0,0281 m³
E27 max 3 x 60W

081441 € 82
091013 € 82

1,930 Kg / 0,0160 m³
E27 max 2 x 60W

081434 € 54
091006 € 54



091013



081434

3000 K / 360 Lm
101286 € 3,00

3000 K / 360 Lm
101286 € 3,00

Esil

Diffusore in vetro trasparente sabbato con decorazione serigrafata e applicazioni di elementi in cristallo molato. Viti ferma vetro in metallo cromato.

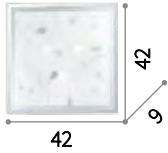

IP20
 2,930 Kg / 0,0243 m³
 E27 max 3 x 60W
 080390 € 85



3000 K / 360 Lm
 101286 € 3,00

Steno

Base in metallo con vetro serigrafato e sabbato. Diffusore in vetro con decorazione serigrafata e applicazioni di elementi in cristallo molato.

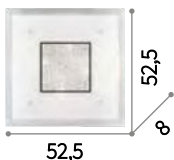

IP20
 4,600 Kg / 0,0566 m³
 E27 max 4 x 60W
 087597 € 177

3000 K / 430 Lm
 101279 € 2,90

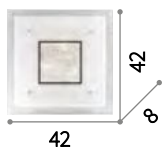

IP20
 3,000 Kg / 0,0339 m³
 E27 max 3 x 60W
 087580 € 116

3000 K / 430 Lm
 101279 € 2,90

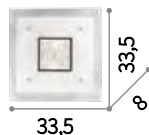

IP20
 1,800 Kg / 0,0173 m³
 E27 max 2 x 60W
 087573 € 76

3000 K / 430 Lm
 101279 € 2,90



Mito

Montatura in metallo con finitura in vernice bianca opaca. Lampadine GX53 sostituibili.

LED Lampadine LED GX53 9,5W 3000 K incluse. Cod. 123936

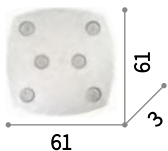

IP20
6,530 Kg / 0,0198 m³
GX53 max 6 x 15W
175690 € 214

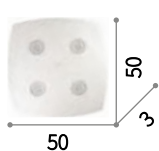

IP20
4,740 Kg / 0,0144 m³
GX53 max 4 x 15W
175706 € 164

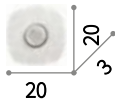

IP20
0,700 Kg / 0,0024 m³
GX53 max 1 x 15W
175676 € 50

3000 K / 760 Lm
123936 € 5,90

3000 K / 760 Lm
123936 € 5,90

3000 K / 760 Lm
123936 € 5,90

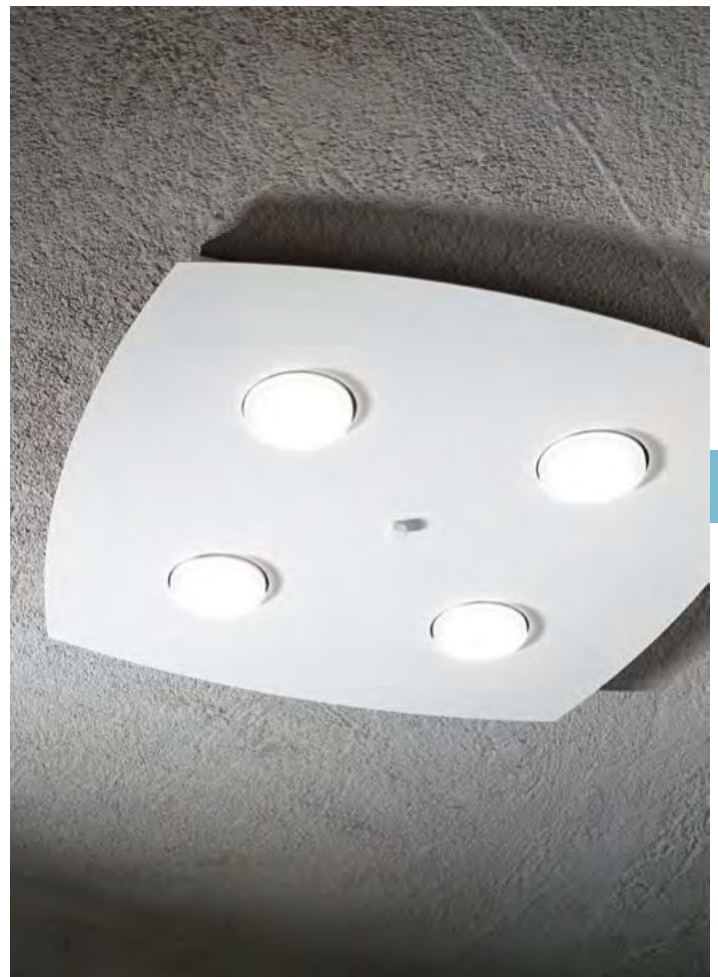

Totem

Base in metallo sagomato a laser e verniciato bianco opaco. Lampadine led GX53 sostituibili.

LED Lampadine LED GX53 9,5W 3000 K incluse. Cod. 123936

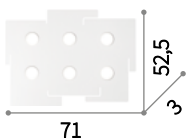

IP20
5,140 Kg / 0,0454 m³
GX53 max 6 x 15W
215785 € 190

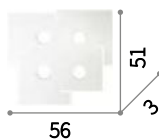

IP20
3,770 Kg / 0,0312 m³
GX53 max 4 x 15W
215778 € 145

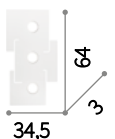

IP20
2,870 Kg / 0,0220 m³
GX53 max 3 x 15W
215761 € 120

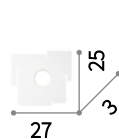

IP20
0,930 Kg / 0,0053 m³
GX53 max 1 x 15W
215747 € 50

3000 K / 760 Lm
123936 € 5,90

3000 K / 760 Lm
123936 € 5,90

3000 K / 760 Lm
123936 € 5,90

3000 K / 760 Lm
123936 € 5,90

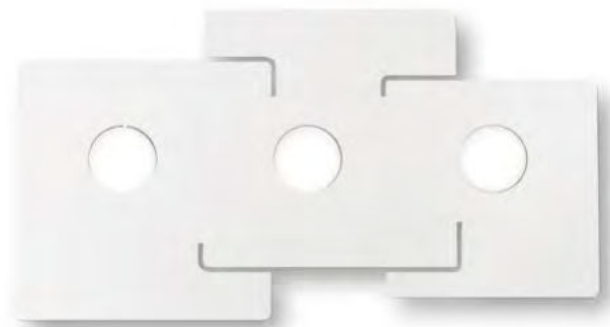

Ali

Diffusore in vetro bianco acidato composto da tre elementi: due laterali e uno frontale. Viti fermavetro cromate.

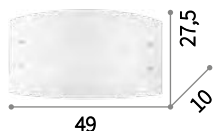

IP20

2,510 Kg / 0,0350 m³
E27 max 4 x 60W

026565 € 85

3000 K / 360 Lm
101286 € 3,00



P. 216



Dony

Diffusore in vetro trasparente soffiato ed acidato. Decorazioni serigrafate in bianco. Ganci ferma vetro in metallo cromato.

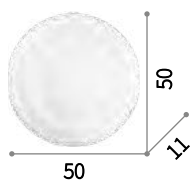

IP20

3,440 Kg / 0,0535 m³
E27 max 4 x 60W

019642 € 85

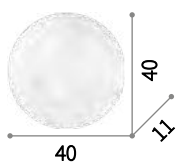

IP20

1,880 Kg / 0,0389 m³
E27 max 3 x 60W

019635 € 53

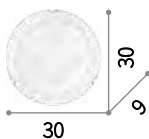

IP20

1,100 Kg / 0,0202 m³
E27 max 2 x 60W

020891 € 33

3000 K / 360 Lm
101286 € 3,00

3000 K / 360 Lm
101286 € 3,00

3000 K / 360 Lm
101286 € 3,00



Geko

Montatura in metallo smaltato bianco.
Diffusore con vetro trasparente serigrafato in bianco. Elemento centrale fissa vetro in metallo cromato.

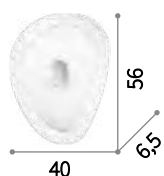

IP20

3,820 Kg / 0,0385 m³
E27 max 4 x 60W

116112 € 137

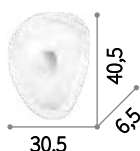

IP20

2,000 Kg / 0,0203 m³
E27 max 3 x 60W

018508 € 97

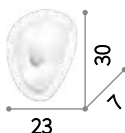

IP20

1,200 Kg / 0,0130 m³
E27 max 2 x 60W

010861 € 67

3000 K / 360 Lm
101286 € 3,00

3000 K / 360 Lm
101286 € 3,00

3000 K / 360 Lm
101286 € 3,00



Gemma ^{new}

Base in plastica con varie finiture.
Diffusore in policarbonato bianco opaco.
Sistema di fissaggio rapido. Sorgente led integrata sostituibile.

LED Sorgente luminosa LED 3000 K,
20.000 h di durata.

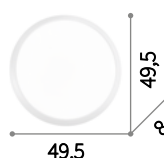

IP20

1,210 Kg / 0,0400 m³
LED 36W / 2400 Lm

252636 € 60 **new**
252643 € 60 **new**

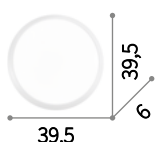

IP20

0,760 Kg / 0,0275 m³
LED 24W / 1650 Lm

252612 € 35 **new**
252629 € 35 **new**

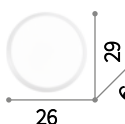

IP20

0,430 Kg / 0,0163 m³
LED 12W / 720 Lm

252599 € 25 **new**
252605 € 25 **new**



Save

Montatura in metallo cromato. Diffusore in vetro soffiato bianco acidato.

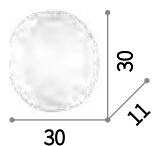

■ ■ ⊕ IP20

2,000 Kg / 0,0281 m³
E27 max 1 x 60W

093345 ■ € 80



3000 K / 720 Lm
123899 € 6,90

Ring

Montatura in metallo cromato. Diffusore in vetro bianco soffiato e acidato con fissaggio a baionetta.



■ ■ ⊕ △ IP20

2,020 Kg / 0,0370 m³
E27 max 3 x 60W

045733 ■ € 93

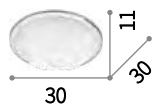

■ ■ ⊕ △ IP20

1,220 Kg / 0,0217 m³
E27 max 2 x 60W

045726 ■ € 72



3000 K / 360 Lm
101286 € 3,00



3000 K / 360 Lm
101286 € 3,00

Toffee

Base in metallo cromato. Diffusore in vetro trasparente acidato.

LED Lampadine LED GX53 9,5W 3000 K include. Cod. 123936

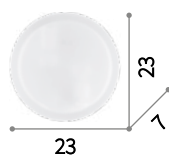

2,120 Kg / 0,0080 m³
GX53 max 1 x 15W
104485 € 78

3000 K / 760 Lm
123936 € 5,90

Simply

Diffusore in vetro trasparente sabbato. Ganci ferma vetro in metallo smaltato con sistema di bloccaggio a molla.

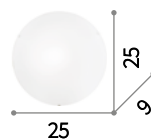
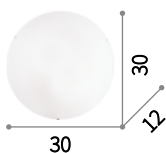
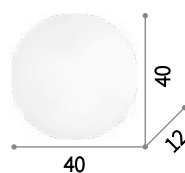
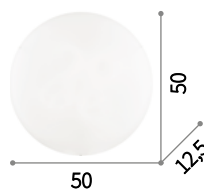

3,190 Kg / 0,0487 m³
E27 max 4 x 60W
007991 € 68

1,670 Kg / 0,0284 m³
E27 max 3 x 60W
007984 € 44

1,010 Kg / 0,0172 m³
E27 max 2 x 60W
007977 € 30

0,670 Kg / 0,0131 m³
E27 max 1 x 60W
007960 € 22

3000 K / 360 Lm
101286 € 3,00

3000 K / 360 Lm
101286 € 3,00

3000 K / 360 Lm
101286 € 3,00

3000 K / 360 Lm
101286 € 3,00

Logos

Montatura in metallo con finitura in vernice bianca opaca. Lampadine GX53 sostituibili.

LED Lampadine LED GX53 9,5W 3000 K incluse. Cod. 123936

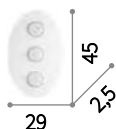
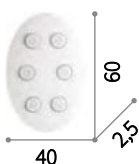

IP20



INCLUSA



IP20



2,850 Kg / 0,0278 m³
GX53 max 6 x 15W

175799 € 214

1,450 Kg / 0,0160 m³
GX53 max 3 x 15W

175768 € 143

3000 K / 760 Lm
123936 € 5,90

3000 K / 760 Lm
123936 € 5,90



P. 225



Lunare

Base e corpo luce interamente in metallo con finitura bianco. Cavo esterno rivestito da spirale metallica. Diffusori posizionabili.

LED Lampadine LED GU10 7W 3000 K incluse. Cod.123943

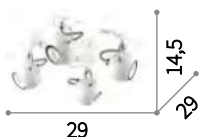

IP20



INCLUSA



1,700 Kg / 0,0188 m³
GU10 max 4 x 28W

077918 € 140

3000 K / 640 Lm
123943 € 3,90



P. 256

P. 648







Oby

Montatura in metallo verniciato bianco opaco, con snodi cromati. Corpo luce orientabile con diffusore in materiale plastico bianco.

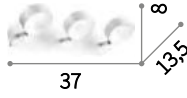
LED Sorgente luminosa LED 3000 K, 20.000 h di durata.

 <p>55</p>	 <p>37</p>
 IP20	 IP20
1,210 Kg / 0,0058 m ³ LED 24W / 1600 Lm	0,870 Kg / 0,0038 m ³ LED 18W / 1200 Lm
196718 ■ € 210	196701 ■ € 147



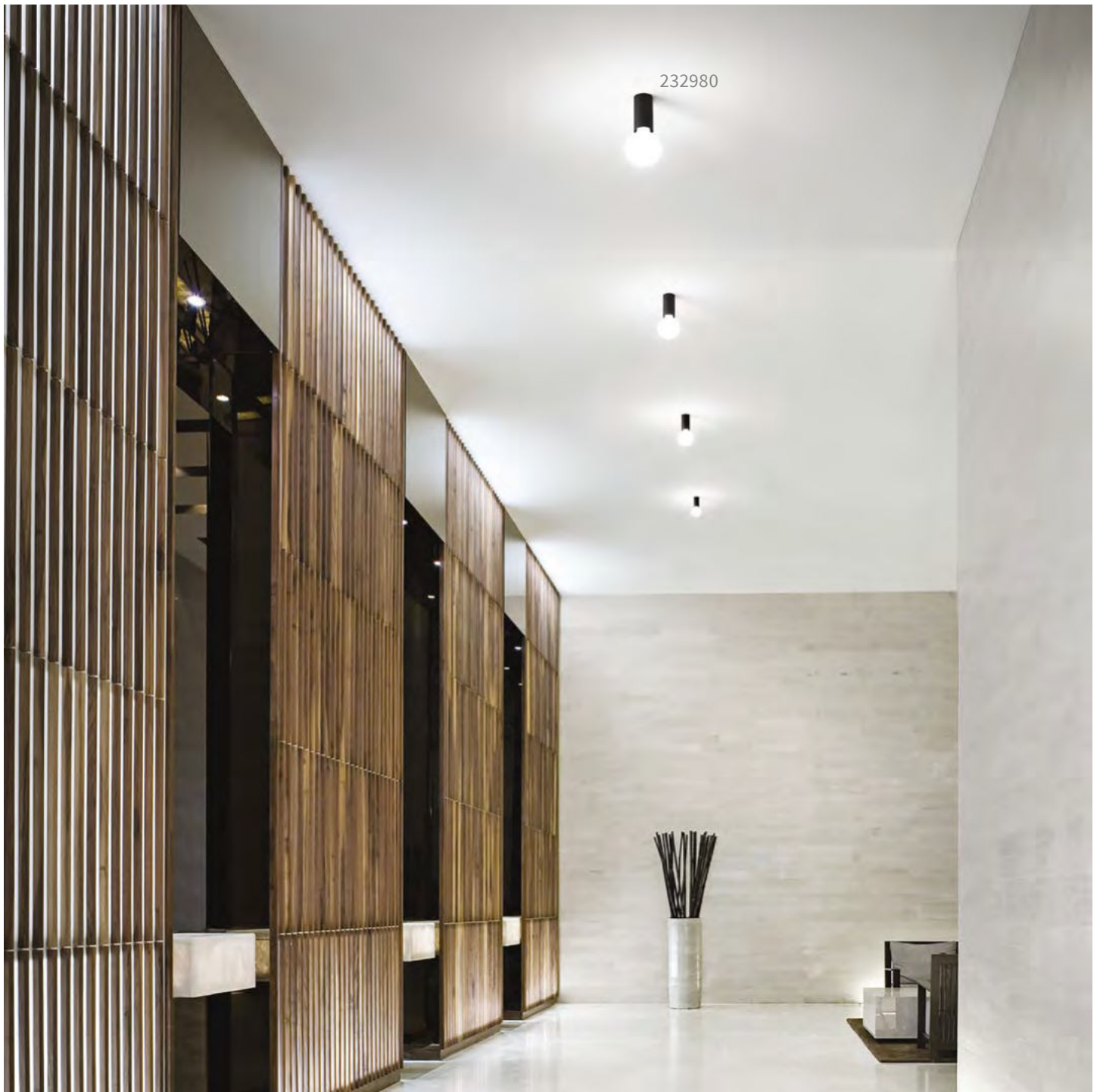

232980

Petit **new**

Corpo luce in metallo verniciato opaco bianco, nero o placcato ottone o cromo.

LED Lampadine LED E27 8W Globo D95 3000 K incluse. Cod. 101330

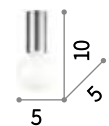

0,790 Kg / 0,0007 m³
E27 max 1x60W

232966 € 18 **new**
233017 € 18 **new**
233031 € 20 **new**
232980 € 18 **new**

3000 K / 720 Lm
101330 € 8,50



006338



122731 089584 119830

Alfa

Montatura in metallo con finitura in cromo, brunito, bianco satinato o nickel satinato. Corpo luce posizionabile con rotazione dello stelo e snodo per l'inclinazione.

 Lampadine alogene GU10 28W 2700 K incluse.

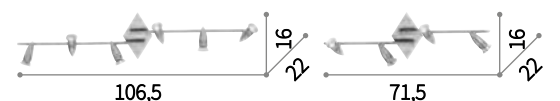

  IP20    IP20 

1,140 Kg / 0,0196 m³
GU10 max 6 x 50W

1,070 Kg / 0,0138 m³
GU10 max 4 x 50W

122748 € 100
089591 € 100
006338 € 100

122731 € 70
089584 € 70
006321 € 70
119830 € 75

 3000 K / 400 Lm
108292 € 3,50

 3000 K / 400 Lm
108292 € 3,50



P. 257

Slem

Montatura in metallo con finitura in bianco, cromo o nickel satinato. Corpo luce posizionabile con rotazione dello stelo e snodo per l'inclinazione.

 Lampadine alogene GU10 28W
2700 K incluse.

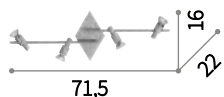

1,070 Kg / 0,0152 m³
GU10 max 4 x 50W

142098 € 70
142067 € 70
018850 € 70

 3000 K / 400 Lm
108292 € 3,50



P. 258



099064 122984

Elis

Montatura in metallo cromato. Corpo luce orientabile. Diffusore in vetro pirex trasparente e smerigliato a sabbia nella parte centrale.

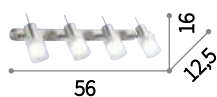

1,250 Kg / 0,0095 m³
E14 max 4 x 40W

031101 € 103

 3000 K / 360 Lm
101217 € 3,00



P. 258



Nostalgia

Montatura in metallo cromato. Base con lastra in vetro bianco. Diffusori posizionabili in vetro trasparente stampato.

 Lampadine alogene G9 28W 2700 K incluse.

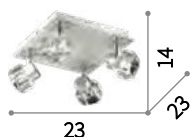

 IP20

2,050 Kg / 0,0107 m³
G9 max 4x40W

077963 € 145



 3000 K / 300 Lm
209043 € 3,50



P. 259

Snake

Montatura in metallo cromato. Corpo luce posizionabile. Diffusore in vetro bianco soffiato e acidato.

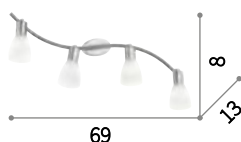

 IP20

1,280 Kg / 0,0137 m³
E14 max 4 x 40W

002781 € 73



 3000 K / 360 Lm
101217 € 3,00



P. 259

Ciak

Montatura in metallo verniciato nero opaco. Diffusore posizionabile con alette mobili per l'orientamento del flusso luminoso.

 Lampadine alogene GU10 28W
2700 K include.



1,700 Kg / 0,0137 m³
GU10 max 4 x 50W
095707 ■ € 144

 3000 K / 400 Lm
108292 ■ € 3,50



P. 257



Movie

Montatura interamente in metallo verniciato nero opaco. Diffusore orientabile con alette mobili per la regolazione del flusso luminoso.

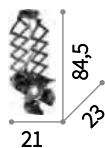

2,190 Kg / 0,0166 m³
E27 max 1 x 60W
155500 ■ € 170

 3000 K / 720 Lm
101330 ■ € 8,50



P. 314



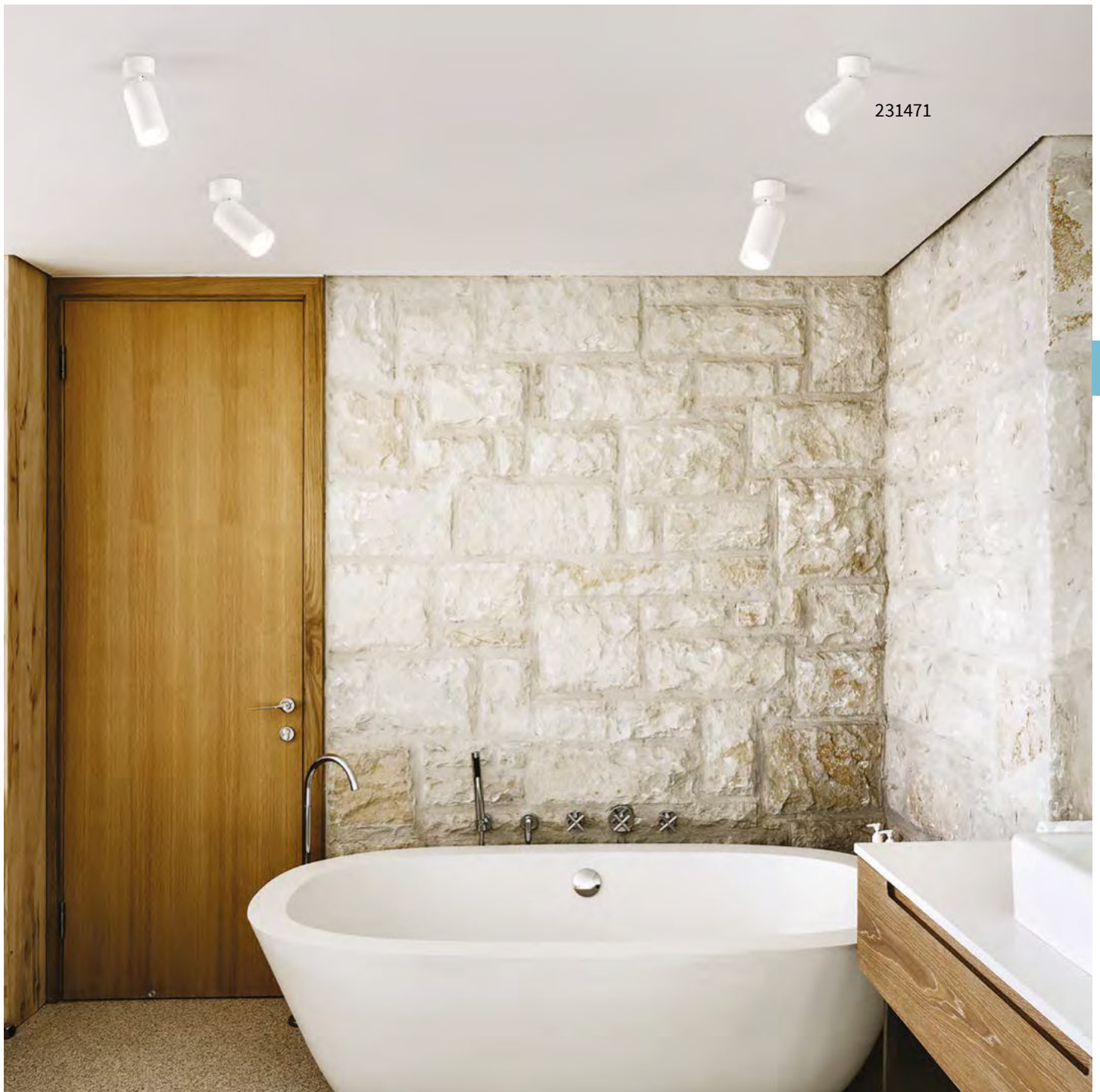

Dynamite **new**

Montatura in metallo verniciato a polveri o placcato. Diffusori orientabili.

LED Lampadine LED GU10 7W 3000 K include. Cod.123943



231471



244662



0,430 Kg / 0,0022 m³
GU10 max 1x28W

231495 € 75 **new**
244662 € 85 **new**
231471 € 75 **new**

3000 K / 640 Lm
123943 € 3,90

Moderno

Lampade da parete



Nodi 192



Corallo 192



Rain 193



Giada 193



Aurora 194



Neve 194



Moonlight 195



Edison 200



Picchio 201



Elica 202



Lana 202



Smarties 203



Ovalino 203



Penombra 204



Effetti 209



Sheraton 210



Gea 211



Woody 212



Hilton 212



Multiflex 213



Tender 213



Union 218



Tick 219



Vela 220



Commodore 220



Fix 221



Gingle 222



Rubens 223



Clip 231



Flash 232



Tek 233



Denis 233



Pila 234



Camerino 234



Line 235



Mirror-20 243



Mirror-51 243



Arco 244



Cico 244



Double 245



Lucciola 245



Focus 246



Book 254



Gim 255



Hellen 255



Oby 256



Lunare 256



Ciak 257



Alfa 257

						
Admiral 195	Roma 196	Orion 196	Calypso 197	Audi-61 197	Radio 198	Minimal 199
						
Mapa 204	Luxury 205	Phoenix 205	Basket 206	Nordik 206	Hotel 207	Holiday 208
						
Tudor 214	Paul 214	Puzzle 215	Anello 215	Ali 216	Triplo 216	Audi-B 217
						
Sunrise 224	Logos 225	Tea 226	Moris 227	Zed 228	Box 229	Posta 230
						
Toy 235	Subway 236	Privè 237	Alma 238	Bonjour 239	Bow 240	Mirror-10 242
						
Goose 248	Page 249	Lite 250	Flex 251	Dynamo 251	Probe 252	Read 253
						
Slem 258	Elis 258	Nostalgia 259	Snake 259			

Nodi

Montatura in metallo cromato. Elementi di giunzione ruotabili per una disposizione personalizzata. Diffusori in vetro bianco soffiato, acidato o trasparente e cromato.

LED Lampadine LED G4 2W 3000 K
incluse. Cod. 222257

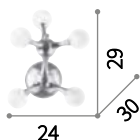

1,400 Kg / 0,0245 m³
G4 max 5x20W

022277 € 146
200477 € 240



 3000 K / 170 Lm
222257 € 3,90

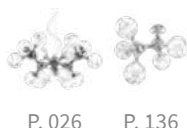

Corallo

Montatura a sfera e dettagli in metallo cromato. Elementi decorativi in vetro bianco lavorato a mano.

LED Lampadine LED G9 3,2W 3000 K
incluse. Cod. 209043

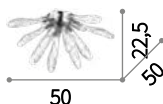

1,920 Kg / 0,0162 m³
G9 max 3x40W

081960 € 227



 3000 K / 300 Lm
209043 € 3,50

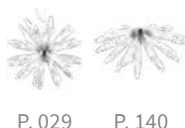

Rain

Montatura in metallo cromato. Pendagli con elementi in cristallo colorato e molato in varie forme e gocce finali.

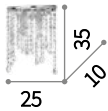

IP20

0,750 Kg / 0,0032 m³
E14 max 2 x 40W

008325 € 57



3000 K / 430 Lm
101224 € 2,90



P. 038



P. 143



P. 262



P. 292



Giada

Montatura in metallo cromato. Pendagli con elementi ottagonali e puntali finali in cristallo molato.



Lampadine alogene G9 28W 2700 K
includ.

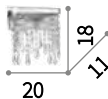

IP20

0,890 Kg / 0,0030 m³
G9 max 2 x 40W

098784 € 88

099217 € 90



3000 K / 300 Lm
209043 € 3,50



P. 039



P. 143

098784



099217



Aurora

Montatura in metallo cromato. Pendagli con elementi in cristallo molato ottagonali.

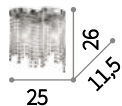

IP20

0,900 Kg / 0,0039 m³
E14 max 2 x 40W

013763 € 96



3000 K / 430 Lm
101224 € 2,90



P. 040



Neve

Montatura in metallo. Elementi decorativi con sfere di vetro fissate a fili di nylon. Disponibile con montatura cromata e sfere trasparenti o con montatura in bianco opaco e sfere bianche e trasparenti.

Lampadine alogene G9 28W 2700 K incluse.

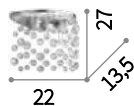

IP20

2,070 Kg / 0,0041 m³
G9 max 3 x 40W

106021 € 95
033938 € 90



3000 K / 300 Lm
209043 € 3,50



P. 144



P. 263

033938



106021



Moonlight

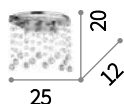

Montatura in metallo con finitura disponibile in cromo o dorato. Pendagli con ottagoni e sfere in cristallo molato.

 Lampadine alogene G9 28W 2700 K incluse.





0,800 Kg / 0,0041 m³
G9 max 3x40W

077833  € 96
082813  € 102

 3000 K / 300 Lm
209043 € 3,50



P. 146

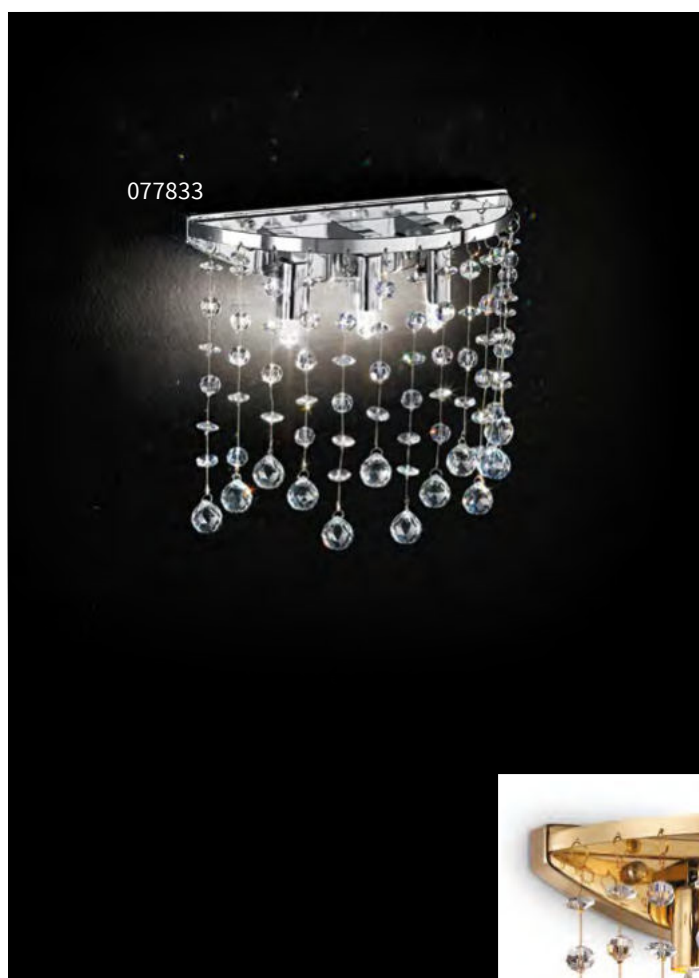

082813

Admiral

Diffusore composto da anelli in metallo saldati tra loro e da elementi in cristallo molato incastonati all'interno.

 Lampadine LED G9 3,2W 3000 K incluse. Cod. 209043

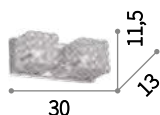



1,490 Kg / 0,0113 m³
G9 max 2x40W

080857  € 158

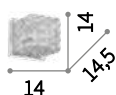



1,080 Kg / 0,0058 m³
G9 max 1x40W

080284  € 100

 3000 K / 300 Lm
209043 € 3,50

 3000 K / 300 Lm
209043 € 3,50



P. 149



Roma

Montatura e dettagli in metallo cromato.
Diffusore con elementi quadrati in
cristallo molato sulla fascia laterale e
vetro sabbato sul fondo.

 Lampadine alogene G9 28W
2700 K incluse.

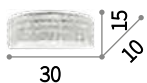

 IP20 

1,200 Kg / 0,0147 m³
G9 max 2x40W

093086  € 136

 3000 K / 300 Lm
209043 € 3,50



Orion

Diffusore composto da anelli in metallo
cromato con ottagoni di cristallo
incastonati all'interno.

 Lampadine LED G9 3,2W 3000 K
incluse. Cod. 209043



 IP20 

1,050 Kg / 0,0132 m³
G9 max 2x40W

059112  € 96

 3000 K / 300 Lm
209043 € 3,50



Calypso

Montatura in metallo cromato. Elementi decorativi in cristallo molato.

LED Lampadine LED G9 3,2W 3000 K
incluse. Cod. 209043

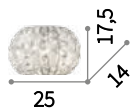

IP20
1,420 Kg / 0,0146 m³
G9 max 2x40W
044163 € 113

3000 K / 300 Lm
209043 € 3,50



P. 045

P. 153

Audi-61

Montatura in metallo cromato. Catene di ottagononi in cristallo. Diffusore in vetro soffiato.

LED Lampadine LED G9 3,2W 3000 K
incluse. Cod. 209043

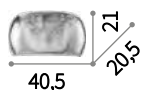

IP20
3,370 Kg / 0,0431 m³
G9 max 4x40W
133911 € 228

3000 K / 300 Lm
209043 € 3,50



P. 048

P. 153





119465

Radio

Rosone e montatura in metallo. Diffusore posizionabile. Cavo elettrico in tessuto. Disponibile con finitura in cromo o con vernice opaca bianca o nera.

LED

Lampadine LED E27 8W Globo D125 trasparente 3000 K incluse.
Cod. 101347



P. 056



P. 311

119427



119502

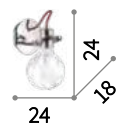

IP20

0,450 Kg / 0,0119 m³
E27 max 1x60W

119465 € 50

119427 € 55

119502 € 50



3000 K / 860 Lm
101347 € 8,90



045191

Minimal

Montatura in metallo rifinito in cromo o in smalto colorato. Cavo elettrico con rivestimento in tessuto.

LED Lampadine LED E27 8W Globo D125 trasparente 3000 K incluse. Cod. 101347

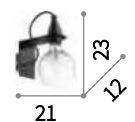

IP20 

0,720 Kg / 0,0164 m³
E27 max 1 x 60W

045191  € 60
045207  € 60
045214  € 60



P. 057 P. 312

 3000 K / 860 Lm
101347 € 8,90



Edison

Montatura in metallo rifinito in smalto opaco bianco o nero. Cavo elettrico in tessuto.

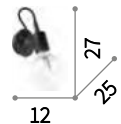

■  IP20

0,410 Kg / 0,0130 m³
E27 max 1 x 60W

138374  € 46
148908  € 46



P. 059



3000 K / 860 Lm
101347 € 8,90



Picchio

Lampada a pinza con montatura e copriportampada in metallo. Filo elettrico in tessuto. Disponibile con finitura in cromo o smaltata in bianco.

ON
OFF Lampada con interruttore integrato.

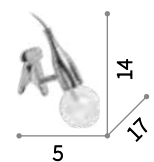

■ □ IP20

0,420 Kg / 0,0023 m³
E27 max 1 x 60W

098944 ■ € 45
098951 ■ € 45

💡 3000 K / 860 Lm
101323 € 7,90

Elica

Montatura in nickel satinato. Diffusore in vetro bianco soffiato, incamiciato e acidato.

LED Lampadine LED G9 3,2W 3000 K incluse. Cod. 209043

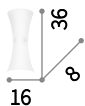

IP20

0,980 Kg / 0,0217 m³
G9 max 2x40W

017617 € 63

3000 K / 300 Lm
209043 € 3,50

P. 264

P. 292



Lana

Diffusore in vetro trasparente con decorazioni serigrafate all'interno e sabbiate all'esterno. Ganci ferma vetro in metallo cromato.

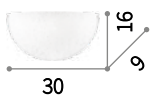

IP20

0,470 Kg / 0,0094 m³
E27 max 1 x 60W

068121 € 24

3000 K / 360 Lm
101286 € 3,00

P. 088

P. 163



Smarties

Montatura in metallo. Diffusore in vetro bianco soffiato e acidato.

LED Lampadine LED G9 3,2W 3000 K
incluse. Cod. 209043

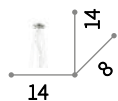

0,440 Kg / 0,0079 m³
G9 max 1x40W

014814 € 32



3000 K / 300 Lm
209043 € 3,50



P. 090



P. 158



P. 265

Ovalino

Diffusore composto da elementi circolari in lastra di vetro curvata e acidata.

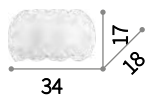

1,800 Kg / 0,0563 m³
E27 max 2 x 60W

038025 € 100



3000 K / 360 Lm
101286 € 3,00



P. 095



P. 162

Penombra

Montatura e vela superiore in metallo rifinito in ottone. Diffusore in vetro bianco soffiato e acidato.

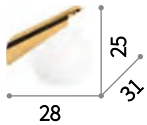

IP20

1,830 Kg / 0,0339 m³
E27 max 1 x 60W

176666 € 130



3000 K / 720 Lm
123899 € 6,90



Mapa

Montatura in metallo cromato o bianco. Diffusore a sfera in vetro bianco soffiato e acidato o in vetro trasparente cromato con sfumatura verso il basso.

LED Lampadine LED G9 3,2W 3000 K incluse nel modello 059808. Cod. 209043

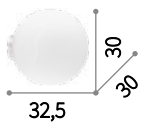

IP20

1,660 Kg / 0,0647 m³
E27 max 1 x 60W

059822 € 76
186856 € 128

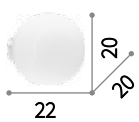

IP20

0,900 Kg / 0,0259 m³
E27 max 1 x 60W

059815 € 42
186849 € 77

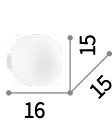

IP20

0,380 Kg / 0,0115 m³
G9 max 1 x 40W

059808 € 36

3000 K / 860 Lm
119571 € 6,50

3000 K / 860 Lm
119571 € 6,50

3000 K / 300 Lm
209043 € 3,50

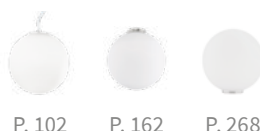

Luxury

Montatura in metallo rifinita in ottone o cromo. Base nera opaca. Paralume in pvc con bordi in tessuto.

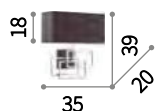

IP20

1,220 Kg / 0,0371 m³
E27 max 1 x 60W

201054 € 188
201092 € 197

3000 K / 860 Lm
119571 € 6,50



201092



201054

Phoenix

Montatura in metallo cromato. Paralume con telaio in metallo e rivestimento in tessuto. Elementi decorativi con catene di ottagononi in cristallo molato.

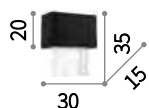

IP20

1,100 Kg / 0,0306 m³
E14 max 2 x 40W

115696 € 146
113715 € 146

3000 K / 360 Lm
101217 € 3,00



113715



115696

Basket

Montatura in metallo cromato. Diffusore in spago ignifugo.

 Lampadine alogene G9 28W 2700 K incluse.

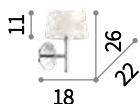

 IP20

0,470 Kg / 0,0064 m³
G9 max 1x40W

082493 € 60

 3000 K / 300 Lm
209043 € 3,50



Nordik

Montatura in metallo verniciato nero opaco. Paralume in lamina di PVC dorato rivestito in tessuto nero.

 Sorgente luminosa LED 3000 K, 15.000 h di durata.

 Lampada con interruttore integrato.

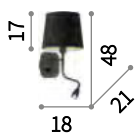

 IP20

0,630 Kg / 0,0156 m³
E14 max 1x40W +
LED 1W / 45 Lm

158242 € 86

 3000 K / 430 Lm
101200 € 2,90





Hotel

Paralume rivestito in tessuto. Diffusori in vetro satinato. Modello AP2 con LED esterno orientabile e interruttore indipendente.

LED Sorgente luminosa LED 3000 K nel modello 215693, 035949, 103204, 215709 e 035956, 15.000 h di durata.

ON OFF Lampada con interruttore integrato nei modelli: 215693, 035949, 103204, 215709 e 035956.



103204



215709



215693

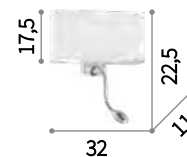

IP20

1,410 Kg / 0,0166 m³
E27 max 1 x 60W +
LED 1W / 45 Lm

215693 € 85
035949 € 85
103204 € 85
215709 € 85
035956 € 85

3000 K / 720 Lm
123899 € 6,90



IP20

1,230 Kg / 0,0166 m³
E27 max 1 x 60W
152851 € 60

3000 K / 720 Lm
123899 € 6,90



124179

Holiday

Montatura in metallo con base in vernice opaca e struttura in cromo. Paralume con lamina di pvc rivestita in tessuto. Interruttore unico con controllo indipendente delle due sorgenti luminose.

LED Sorgente luminosa LED 3000 K, 15.000 h di durata.

ON OFF Lampada con interruttore integrato.

124162

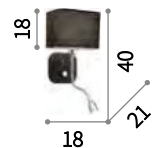

IP20

0,640 Kg / 0,0111 m³
E14 max 1 x 40W +
LED 1W / 45 Lm

124162 € 82
124179 € 82

3000 K / 360 Lm
101217 € 3,00



Effetti

Montatura in metallo verniciato bianco opaco. Paralume in nastro di tessuto. Applique con controllo indipendente delle due sorgenti luminose.

LED Sorgente luminosa LED 3000 K, 15.000 h di durata.

ON OFF Lampada con interruttore integrato.



■  IP20

0,710 Kg / 0,0175 m³
E14 max 1x40W +
LED 1W / 70 Lm

132976 ■ € 100

 3000 K / 360 Lm
101217 € 3,00



074900

Sheraton

Montatura in metallo cromato. Paralumi in lamina di PVC rivestita di tessuto. Applique con luci a controllo indipendente da interruttore unico.

LED Sorgente luminosa LED 3000 K, 15.000 h di durata.

ON/OFF Lampada con interruttore integrato.



074917

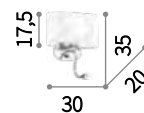

IP20

0,770 Kg / 0,0145 m³
E14 max 1 x 40W +
LED 1W / 45 Lm

074900 € 98
074917 € 98

3000 K / 360 Lm
101217 € 3,00



Gea **new**

Corpo luce in alluminio verniciato a polveri bianco o nero. Diffusore con led integrato orientabile. Paralume in pvc rivestito di tessuto. Presa USB. Interruttori indipendenti.

LED Sorgente luminosa LED 3000 K, 20.000 h di durata.

ON/OFF Lampada con interruttore integrato.

USB Lampada con presa USB integrata.

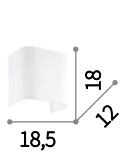

0,140 Kg / 0,0180 m³

239576 € 13 **new**
 239606 € 13 **new**
 239613 € 13 **new**
 239590 € 13 **new**



IP20

0,500 Kg / 0,0021 m³
 E27 max 1x60W + LED 3W / 130 Lm

239521 € 85 **new**
 239545 € 85 **new**

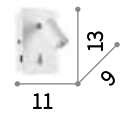

IP20

0,400 Kg / 0,0013 m³
 LED 3W / 130 Lm

239637 € 75 **new**
 239644 € 75 **new**

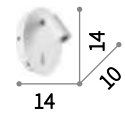

IP20

0,400 Kg / 0,0018 m³
 LED 3W / 130 Lm

239682 € 75 **new**
 239699 € 75 **new**

3000 K / 720 Lm
 123899 € 6,90

Woody

Montatura in metallo cromato. Diffusore in PVC o in tessuto, chiuso sul fondo da vetro trasparente acidato.

 Lampadine alogene G9 28W
2700 K incluse.



 IP20 

0,460 Kg / 0,0100 m³
G9 max 1x40W

143156 € 55
087665 € 55

 3000 K / 300 Lm
209043 € 3,50



Hilton

Montatura in cromo. Paralume in lamina di PVC rivestita in tessuto bianco o nero, chiuso da vetro trasparente acidato.

 Lampadine alogene G9 28W
2700 K incluse.

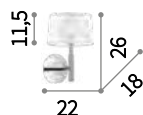

 IP20 

0,700 Kg / 0,0105 m³
G9 max 1x40W

075471 € 60
164601 € 60

 3000 K / 300 Lm
209043 € 3,50



Multiflex

Montatura in metallo rifinito con vernice opaca. Bracci flessibili rivestiti di gomma.

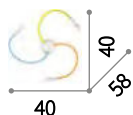

IP20

0,770 Kg / 0,0066 m³

E14 max 3 x 40W

186900 € 86

3000 K / 360 Lm
101217 € 3,00

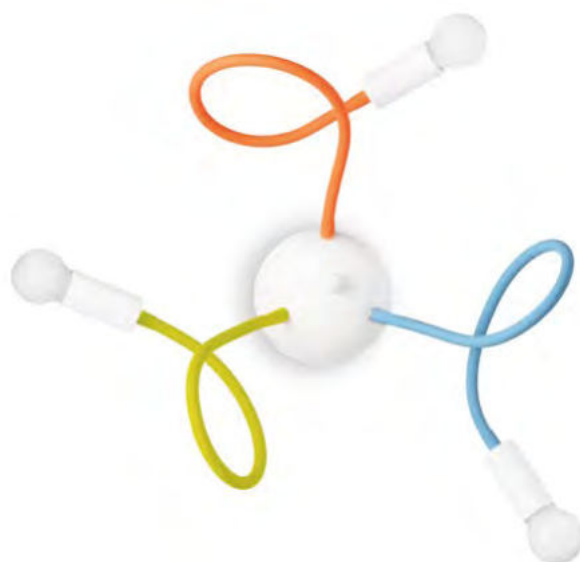

Tender

Montatura in cromo con bracci flessibili.
Diffusori trasparenti in vetro pirex soffiato con parte interna smerigliata.

ON
OFF Lampada con interruttore integrato.



IP20

0,440 Kg / 0,0040 m³

E14 max 1 x 40W

004235 € 36

3000 K / 360 Lm
101217 € 3,00



Tudor

Base in metallo cromato. Diffusore composto da cornice in vetro trasparente molato e mezzo tubo in vetro pirex sabbiato nella parte centrale.

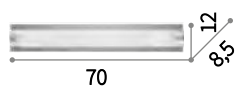

IP20
1,900 Kg / 0,0214 m³
E14 max 4 x 40W
051864 € 84

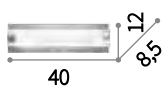

IP20
1,130 Kg / 0,0117 m³
E14 max 2 x 40W
051857 € 54

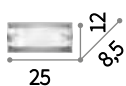

IP20
0,700 Kg / 0,0077 m³
E14 max 1 x 40W
051840 € 40

3000 K / 360 Lm
101217 € 3,00

3000 K / 360 Lm
101217 € 3,00

3000 K / 360 Lm
101217 € 3,00



Paul ^{new}

Montatura in metallo rifinito bianco o nero. Diffusore in vetro soffiato, incamiciato e acidato.

LED Lampadine LED G9 3,2W 3000 K include. Cod. 209043



IP20
0,560 Kg / 0,0064 m³
G9 max 2 x 40W
060620 € 50
231105 € 50 **new**



IP20
0,540 Kg / 0,0056 m³
G9 max 2 x 40W
231129 € 50 **new**
231143 € 50 **new**



060620



231143

3000 K / 300 Lm
209043 € 3,50

3000 K / 300 Lm
209043 € 3,50

Puzzle

Montatura in metallo cromato. Diffusore in vetro soffiato bianco, incamiciato e acidato.

LED Lampadine LED G9 3,2W 3000 K
incluse. Cod. 209043

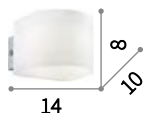

■ IP20 LED

0,520 Kg / 0,0061 m³
G9 max 1x40W

035185 ■ € 42

3000 K / 300 Lm
209043 ■ € 3,50



Anello

Montatura in metallo cromato. Diffusore disponibile in vetro soffiato incamiciato e acidato oppure in vetro trasparente cromato. Copri lampadina in vetro pirex satinato.

Lampadine alogene G9 28W 2700 K
incluse.

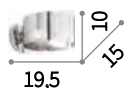

■ IP20 LED

0,400 Kg / 0,0117 m³
G9 max 1x40W

028361 ■ € 45

028323 ■ € 45

3000 K / 300 Lm
209043 ■ € 3,50



028361



028323

Ali

Diffusore in vetro bianco acidato composto da tre elementi: due laterali e uno frontale. Viti fermavetro cromate.



IP20

1,410 Kg / 0,0204 m³
E27 max 2 x 60W

026558 € 45



3000 K / 360 Lm
101286 € 3,00



P. 178

Triplo

Diffusore con triplo vetro, uno trasparente e piano alla base e due smerigliati ad acido e ricurvi sulla parte superiore. Elementi ferma vetro in metallo cromato.

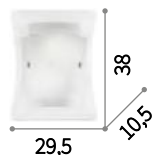

IP20

2,170 Kg / 0,0283 m³
E27 max 2 x 60W

026480 € 58



IP20

1,260 Kg / 0,0141 m³
E27 max 1 x 60W

026473 € 40



3000 K / 360 Lm
101286 € 3,00

3000 K / 360 Lm
101286 € 3,00



Audi-B

Montatura in metallo cromato. Diffusore in lastra di vetro trasparente con spessore di 10 mm. Emette luce verso l'alto e verso il basso.

LED Lampadine LED R7s 6W 78 mm
3000 K incluse. Cod. 189109

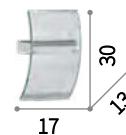

■  IP20 

1,610 Kg / 0,0105 m³
R7s max 1 x 100W

017082 € 70

 3000 K / 850 Lm
189109 € 12,90



Union

Montatura in metallo rifinito con vernice opaca bianca. Diffusore con lastra di vetro trasparente acidato, fissato con magneti.

LED Lampadine LED GX53 9,5W 3000 K incluse. Cod. 123936

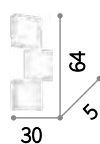

3,950 Kg / 0,0368 m³
GX53 max 3 x 15W
142203 € 178

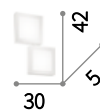

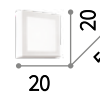

2,640 Kg / 0,0257 m³
GX53 max 2 x 15W
142197 € 118



1,360 Kg / 0,0092 m³
GX53 max 1 x 15W
116099 € 68

 3000 K / 760 Lm
123936 € 5,90

 3000 K / 760 Lm
123936 € 5,90

 3000 K / 760 Lm
123936 € 5,90



238944

Tick **new**

Corpo luce in metallo verniciato a polveri bianco o rifinito in foglia oro o argento.
Diffusore inclinabile di 90°.

LED Sorgente luminosa LED 3000 K,
30.000 h di durata.



238951



238975

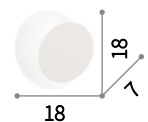

■ □ IP20

0,440 Kg / 0,0028 m³
LED 6W / 390 Lm

238975 ■ € 45 **new**

238951 ■ € 50 **new**

238944 ■ € 50 **new**

Vela

Base in metallo verniciato bianco opaco.
Diffusore dissipatore in lastra curva
d'alluminio da 6 mm di spessore.

LED Sorgente luminosa LED 3000 K,
15.000 h di durata.



■ □ IP20

0,450 Kg / 0,0057 m³
LED 5W / 420 Lm

090337 ■ € 74



Commodore

Corpo luce interamente in metallo con
finitura in vernice bianca opaca.

Lightbulb icon Lampadine LED GX53 9,5W 3000 K
incluse. Cod. 123936

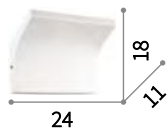

■ □ IP20  INCLUSA

1,170 Kg / 0,0069 m³
GX53 max 2 x 15W

125923 ■ € 95

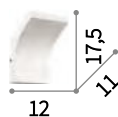

■ □ IP20  INCLUSA

0,640 Kg / 0,0034 m³
GX53 max 1 x 15W

125886 ■ € 65

 3000 K / 760 Lm
123936 € 5,90

 3000 K / 760 Lm
123936 € 5,90





Fix

Base in metallo con finitura bianca opaca o cromo. Diffusore-dissipatore in lastra d'alluminio da 6 mm di spessore. LED integrati.

LED Sorgente luminosa LED 3000 K, 20.000 h di durata.

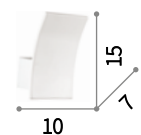

■ □ IP20

0,390 Kg / 0,0050 m³
LED 5W / 420 Lm

117867 ■ € 75
123066 ■ € 90



Gingle

Base e corpo luce in metallo verniciato a polveri. Sorgente luminosa a led integrati con emissione di luce riflessa.

LED Sorgente luminosa LED 3000 K, 17.500 h di durata.

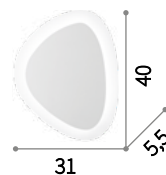

■ ■ □ IP20
1,540 Kg / 0,0233 m³
LED 34W / 3550 Lm
196220 € 230

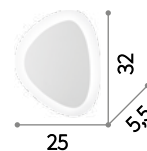

■ ■ □ IP20
1,000 Kg / 0,0139 m³
LED 26W / 2580 Lm
196206 € 165

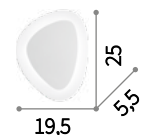

■ ■ □ IP20
0,730 Kg / 0,0153 m³
LED 18W / 1940 Lm
196190 € 115



Rubens

Montatura e ferma vetro centrale in metallo rifinito bianco opaco. Diffusore in vetro trasparente con graniglia.

LED Sorgente luminosa LED 3000 K, 20.000 h di durata.

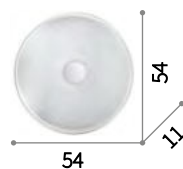

54
 ■ □ ⊕ IP20
 4,700 Kg / 0,0648 m³
 LED 50W / 4000 Lm
 178790 ■ € 250

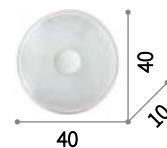

40
 ■ □ ⊕ IP20
 2,680 Kg / 0,0339 m³
 LED 24W / 1920 Lm
 178783 ■ € 155

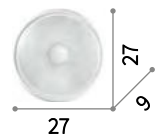

27
 ■ □ ⊕ IP20
 1,210 Kg / 0,0154 m³
 LED 10W / 800 Lm
 178776 ■ € 85



133300

Sunrise

Corpo luce interamente in metallo rifinito con vernice opaca. Disponibile tutto bianco o nero con interno in foglia oro.



Lampadine alogene G9 28W 2700 K incluse.



133263

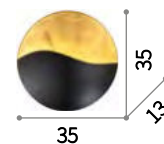

IP20 
 1,290 Kg / 0,0362 m³
 G9 max 4 x 40W
 133300 € 167

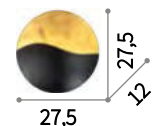

IP20 
 0,850 Kg / 0,0224 m³
 G9 max 3 x 40W
 133263 € 103
 133270 € 140

 3000 K / 300 Lm
 209043 € 3,50

 3000 K / 300 Lm
 209043 € 3,50



Logos

Montatura in metallo con finitura in vernice bianca opaca. Lampadine GX53 sostituibili.

LED Lampadine LED GX53 9,5W 3000 K incluse. Cod. 123936

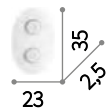

IP20  

0,910 Kg / 0,0103 m³
GX53 max 2 x 15W

175720 € 85



P. 182

 3000 K / 760 Lm
123936 € 5,90



142333

Tea

Corpo luce in fusione di alluminio rifinito con vernici opache a polveri. Doppio diffusore in acrilico trasparente satinato: uno sopra e uno sotto.

LED Sorgente luminosa LED 3000 K, 30.000 h di durata.



142340

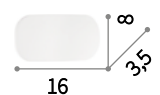

IP20

0,440 Kg / 0,0029 m³
LED 6W / 450 Lm

142340 € 82
142333 € 82



Moris

Diffusore in vetro soffiato incamiciato e acidato bianco o in vetro trasparente rifinito in cromo.

 Lampadine alogene G9 28W 2700 K incluse.



0,520 Kg / 0,0071 m³
G9 max 2 x 40W

034546 € 60
134987 € 74

 3000 K / 300 Lm
209043 € 3,50



115160

Zed

Base in metallo con finitura bianca o cromata. Diffusore-dissipatore in lastra d'alluminio da 6 mm di spessore. LED integrati.

LED Sorgente luminosa LED 3000 K, 20.000 h di durata.



115153

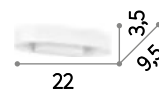

IP20
0,460 Kg / 0,0023 m³
LED 5W / 390 Lm

115153 € 78
115160 € 82



IP20

0,380 Kg / 0,0024 m³
LED 5W / 390 Lm

115177 € 78



115177



009537

009513

Box

Montatura in metallo cromato. Diffusore in vetro soffiato, incamiciato e acidato. Bianco all'interno e colorato all'esterno.

 Lampadine alogene G9 28W 2700 K incluse.

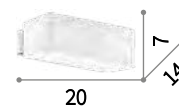

 IP20 

0,660 Kg / 0,0100 m³
G9 max 2 x 40W

009537  € 62
009513  € 62

 3000 K / 300 Lm
209043 € 3,50





Posta

Corpo luce in metallo disponibile in alluminio spazzolato, in cromo o smaltato bianco. Diffusore composto di tre vetri trasparenti smerigliati.



Model	Finish	Price (€)
051987	White Enamel	70
009957	Brushed Aluminum	70
051956	Chrome	80
051970	White Enamel	65
009933	Brushed Aluminum	65
051949	Chrome	70
051963	White Enamel	55
009940	Brushed Aluminum	55
051932	Chrome	60

 3000 K / 430 Lm
101200 € 2,90

 3000 K / 430 Lm
101200 € 2,90

 3000 K / 430 Lm
101200 € 2,90



031361

Clip

Corpo luce interamente in lamina di metallo con varie finiture. Nella versione piccola, diffusori in vetro pirex sabbato.

 Lampadine alogene G9 28W 2700 K incluse nei modelli: 049236, 091136, 049229, 091129 e 170923.



088273



014166



187365



088266



44

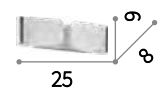

25

 IP20

 IP20 

1,210 Kg / 0,0168 m³
E27 max 2 x 60W

0,730 Kg / 0,0037 m³
G9 max 2 x 40W

014166 € 80

049236 € 68

088273 € 88

091136 € 80

031361 € 80

049229 € 68

088266 € 88

091129 € 80

187365 € 80

170923 € 68

 3000 K / 430 Lm
101279 € 2,90

 3000 K / 300 Lm
209043 € 3,50



007380

Flash

Corpo luce in metallo con finitura in corten, cromo o vernice opaca bianca.



 Lampadine alogene G9 28W 2700 K include.



169118

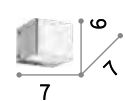
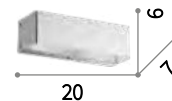

095288





 IP20 
0,360 Kg / 0,0013 m³
G9 max 2 x 40W

 IP20 
0,200 Kg / 0,0005 m³
G9 max 1 x 40W

095288 € 45
007397 € 45

095264 € 25
007380 € 25
169118 € 25

 3000 K / 300 Lm
209043 € 3,50



 3000 K / 300 Lm
209043 € 3,50

Tek



Montatura in metallo cromato. Diffusore con lastra in vetro trasparente molato e smerigliato nella zona centrale.

 Lampadine alogene G9 28W 2700 K incluse.

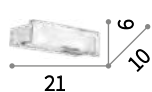

 IP20  INCLUSA
0,850 Kg / 0,0060 m³
G9 max 3 x 40W
052151 € 75



 IP20  INCLUSA
0,600 Kg / 0,0041 m³
G9 max 2 x 40W
052144 € 60

 3000 K / 300 Lm
209043 € 3,50

 3000 K / 300 Lm
209043 € 3,50





Denis



Diffusore con triplo vetro. Due laterali in vetro trasparente acidato e uno frontale trasparente con decorazione bianca centrale serigrafata.

 Lampadine alogene R7s 100W 118 mm 2700 K incluse.



 IP20  INCLUSA
1,070 Kg / 0,0117 m³
R7s max 1 x 100W
005454 € 52



 IP20  INCLUSA
0,820 Kg / 0,0108 m³
R7s max 1 x 100W
005294 € 42

 3000 K / 1200 Lm
189093 € 17,00

 3000 K / 1200 Lm
189093 € 17,00



Pila

Montatura in metallo con finitura in cromo. Diffusore in vetro pirex smerigliato nella parte centrale.

LED Lampadine LED R7s 10W 118 mm
3000 K incluse. Cod. 189093



0,530 Kg / 0,0067 m³
R7s max 1 x 150W

027265 € 68

 3000 K / 1200 Lm
189093 € 17,00



Camerino

Base in alluminio. Diffusore in vetro bianco soffiato e acidato, chiuso alle estremità da dischi in materiale acrilico trasparente.

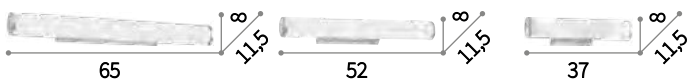

 IP20

1,170 Kg / 0,0157 m³
E14 max 4 x 40W

027104 € 75

 IP20

0,960 Kg / 0,0123 m³
E14 max 3 x 40W

027098 € 65

 IP20

0,780 Kg / 0,0097 m³
E14 max 2 x 40W

027081 € 55

 3000 K / 360 Lm
101217 € 3,00

 3000 K / 360 Lm
101217 € 3,00

 3000 K / 360 Lm
101217 € 3,00



Line

Montatura in metallo con finitura in cromo. Diffusore a LED con barra a sezione quadrata in acrilico satinato.

LED Sorgente luminosa LED 3000 K, 20.000 h di durata.

ON OFF Lampada con interruttore integrato.

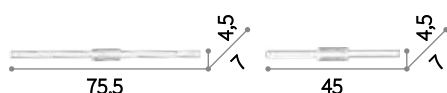

IP20

0,790 Kg / 0,0046 m³
LED 8,4W / 740 Lm

031491 € 147

IP20

0,540 Kg / 0,0028 m³
LED 4,8W / 420 Lm

031484 € 108



Toy

Montatura in alluminio cromato. Predisposto per fissaggio diretto su specchio. Diffusore acrilico. Driver esterno.

LED Sorgente luminosa LED 3000 K, 20.000 h di durata.

IP44 Grado di protezione IP44.

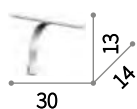

IP44

0,360 Kg / 0,0074 m³
LED 7,2W / 490 Lm

005225 € 65





Subway ^{new}

Montatura in metallo verniciato bianco opaco. Diffusore cilindrico in vetro bianco.

LED Sorgente luminosa LED 3000 K, 20.000 h di durata.

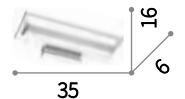

■ □ IP20

0,440 Kg / 0,0105 m³
LED 8W / 600 Lm

224480 ■ € 80 ^{new}

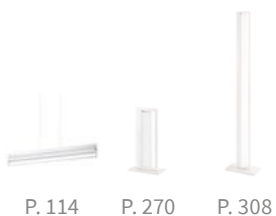

P. 114

P. 270

P. 308



045627

Privè

Corpo luce interamente in metallo con varie finiture. L'assenza di diffusore consente di montare una vasta gamma di lampade con attacco E14.

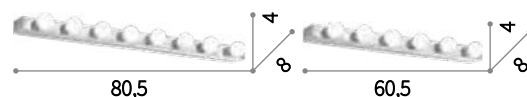

IP20

1,420 Kg / 0,0143 m³
E14 max 8 x 40W

159522 € 97
045634 € 97

IP20

1,100 Kg / 0,0095 m³
E14 max 6 x 40W

159423 € 77
045627 € 77
179681 € 107
187570 € 77
159508 € 77

3000 K / 360 Lm
101217 € 3,00

3000 K / 360 Lm
101217 € 3,00



225029

Alma **new**

Corpo luce in metallo rifinito brunito, cromo o con vernice a polveri bianco. Diffusore fisso in materiale plastico colore opale.

LED Sorgente luminosa LED 3000 K, 20.000 h di durata.



224930

224954

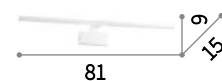

81

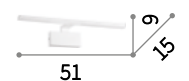

51

■ □ IP20

0,660 Kg / 0,0303 m³
LED 20W / 1300 Lm

225029 □ € 115 **new**
224992 ■ € 130 **new**
225005 ■ € 130 **new**

■ □ IP20

0,650 Kg / 0,0195 m³
LED 12W / 820 Lm

224985 □ € 90 **new**
224930 ■ € 100 **new**
224954 ■ € 100 **new**



Bonjour

Montatura in metallo o bianco. Diffusore inclinabile con schermo in materiale plastico. Interruttore sulla base. Led integrato.

LED Sorgente luminosa LED 3000 K, 20.000 h di durata.



199870



199894

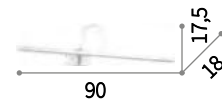

■ □ IP20
0,530 Kg / 0,0346 m³
LED 12W / 900 Lm

199931 □ € 146
199917 ▨ € 168

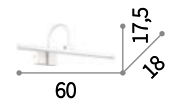

■ □ IP20
0,480 Kg / 0,0220 m³
LED 8W / 650 Lm

199894 □ € 115
199870 ▨ € 136



Bow

Montatura in metallo con finitura disponibile in bianco, brunito, cromo, nickel o ottone satinato. Diffusore a LED inclinabile. Interruttore sulla base.

LED Sorgente luminosa LED 3000 K, 20.000 h di durata.

ON/OFF Lampada con interruttore integrato.

<p>76</p>	<p>46</p>	<p>26</p>
IP20	IP20	IP20
0,860 Kg / 0,0335 m ³ LED 7,98W / 450 Lm	0,790 Kg / 0,0207 m ³ LED 4,62W / 250 Lm	0,640 Kg / 0,0117 m ³ LED 2,52W / 150 Lm
137612 € 152 007021 € 152 007069 € 152 121130 € 152 121147 € 152	137605 € 110 007045 € 110 007038 € 110 121178 € 110 121161 € 110	137599 € 95 005386 € 95 005379 € 95 121154 € 95 121338 € 95



005386



Mirror-10

Montatura in metallo con finitura disponibile in brunito, cromo o nickel. Diffusore posizionabile.

LED Lampadine LED G9 3,2W 3000 K incluse. Cod. 209043

017297



017310

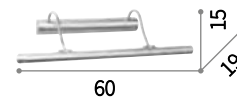

IP20 

1,090 Kg / 0,0181 m³
G9 max 4 x 40W

017303 € 105
017297 € 105
017310 € 105

 3000 K / 300 Lm
209043 € 3,50

Mirror-20

Montatura in metallo con finitura disponibile in brunito, in cromo o in ottone. Diffusore regolabile.

 Lampadine alogene G9 28W 2700 K incluse.

 Lampada con interruttore integrato.

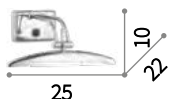

 IP20 

0,550 Kg / 0,0077 m³
G9 max 2 x 40W

017334  € 70

031507  € 70

017327  € 70

 3000 K / 300 Lm
209043 € 3,50



Mirror-51

Montatura in metallo con finitura cromo. Diffusore posizionabile.

 Sorgente luminosa LED 3000 K, 15.000 h di durata.

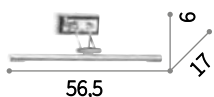

 IP20

0,720 Kg / 0,0081 m³
LED 12W / 1200 Lm

143859  € 118

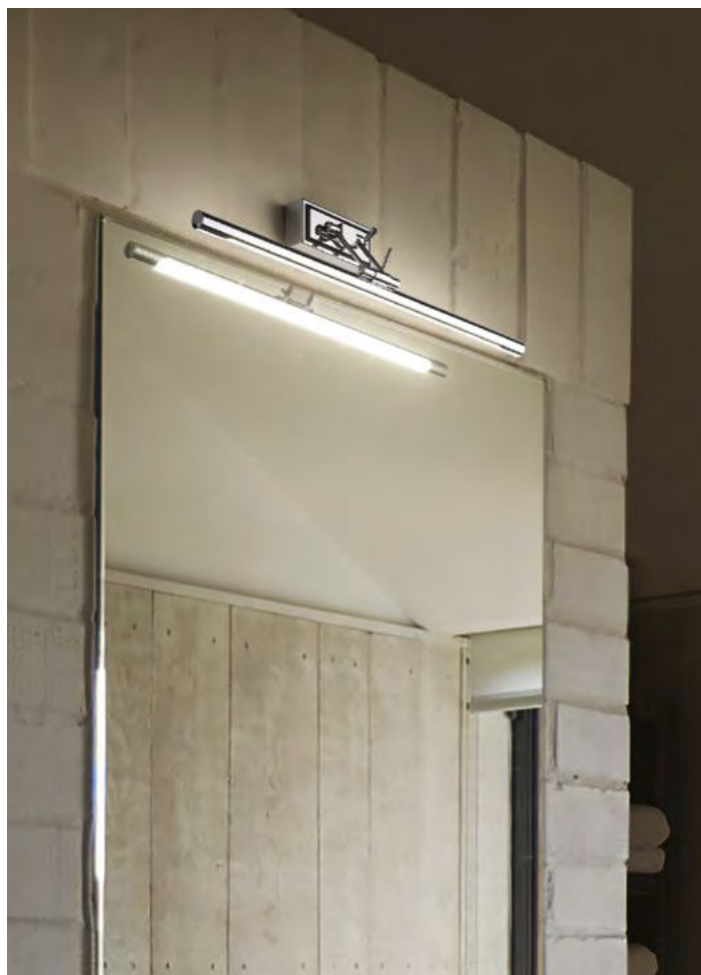

Arco

Montatura in metallo con finitura disponibile in cromo o nickel. Diffusore in tubolare di vetro pirex trasparente con schermo in rete metallica all'interno.



Lampadine alogene R7s 120W 118 mm 2700 K incluse.

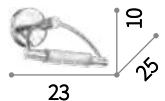

0,580 Kg / 0,0061 m³
R7s max 1 x 150W

008905 € 50
008912 € 50

3000 K / 1200 Lm
189093 € 17,00



Cico

Montatura in metallo con finitura disponibile in cromo, brunito o nickel. Diffusori indipendenti tra loro e posizionabili.



Lampadine alogene G9 28W 2700 K incluse.

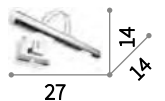

0,530 Kg / 0,0036 m³
G9 max 2 x 40W

014432 € 68
014449 € 68
014456 € 68

3000 K / 300 Lm
209043 € 3,50



Double

Montatura in metallo cromato. Diffusori in vetro pirex trasparente chiuso alle estremità e smerigliato a sabbia nelle parti centrali.

LED Lampadine LED G9 3,2W 3000 K incluse. Cod. 209043

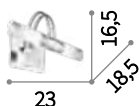

IP20

0,530 Kg / 0,0042 m³
G9 max 2 x 40W

008851 € 50

3000 K / 300 Lm
209043 € 3,50



Lucciola

Montatura in metallo cromato. Diffusore in vetro trasparente acidato.

Lampadine alogene R7s 80W 78 mm 2700 K incluse.

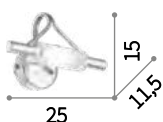

IP20

0,450 Kg / 0,0047 m³
R7s max 1 x 100W

013275 € 56

3000 K / 850 Lm
189109 € 12,90





Focus

Corpo luce in metallo con braccio flessibile orientabile rivestito in gomma. Rifinito in bianco o in nero opaco oppure in grigio con dettagli in cromo.

LED Sorgente luminosa LED 3000 K, 30.000 h di durata.

ON/OFF Lampada con interruttore integrato.



IP20	IP20
0,400 Kg / 0,0025 m ³ LED 3W / 200 Lm	0,410 Kg / 0,0020 m ³ LED 3W / 130 Lm
097183 € 56 097206 € 56 097190 € 56	203171 € 60 203188 € 60 203195 € 60





142708

Goose

Montatura e diffusore in fusione d'alluminio verniciato a polveri con colori opachi. Braccio flessibile rivestito in gomma siliconica.

LED Sorgente luminosa LED 3000 K, 30.000 h di durata.

ON/OFF Lampada con interruttore integrato.



142692



IP20

0,430 Kg / 0,0040 m³
LED 3W / 200 Lm

142708 € 110
142692 € 110



142241

Page **new**

Corpo luce in fusione di alluminio con finitura brunito, cromo o nickel oppure rifinito con vernice a polveri opaca bianca o nera. Diffusore orientabile con lente e elemento snodato in metallo cromato.

LED Sorgente luminosa LED 3000 K, 30.000 h di durata.

ON OFF Lampada con interruttore integrato. 233659

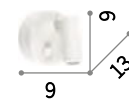

IP20

0,280 Kg / 0,0030 m³
LED 3W / 210 Lm

142586	€ 78
233659	€ 85 new
233673	€ 85 new
233680	€ 85 new
142579	€ 78

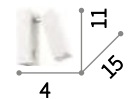

IP20

0,420 Kg / 0,0022 m³
LED 3W / 210 Lm

142258	€ 85
233703	€ 90 new
233857	€ 90 new
233864	€ 90 new
142241	€ 85



Lite **new**

Base e corpo luce in alluminio con finitura bianco, nero, nickel o ottone. Diffusore orientabile. Interruttore incorporato. Installazione ad incasso su scatola di derivazione tipo 502.

LED Sorgente luminosa LED 3000 K, 20.000 h di durata.

ON OFF Lampada con interruttore integrato.



250137



250120

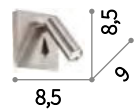

■  IP20

0,340 Kg / 0,0008 m³
LED 3W / 130 Lm

250106  € 45 **new**
250137  € 50 **new**
250120  € 50 **new**
250113  € 45 **new**

Flex

Montatura e braccio flessibile in metallo con finitura disponibile in cromo e nickel. Diffusore orientabile a piacere. Dotato di interruttore sulla base.

LED Lampadine LED GU10 7W 3000 K incluse. Cod.123943

ON/OFF Lampada con interruttore integrato.

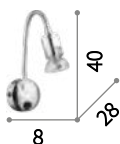

IP20

0,270 Kg / 0,0014 m³
GU10 max 1 x 50W

000305 € 28
006161 € 28

3000 K / 640 Lm
123943 € 3,90



Dynamo

Montatura e braccio flessibile in metallo con finitura disponibile in cromo, nickel e brunito. Diffusore orientabile a piacere. Dotato di interruttore sulla base.

LED Sorgente luminosa LED 4000 K, 20.000 h di durata.

ON/OFF Lampada con interruttore integrato.

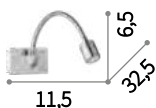

IP20

0,500 Kg / 0,0028 m³
LED 3W / 200 Lm

031460 € 65
031477 € 65
121352 € 70





Probe **new**

Corpo luce in alluminio verniciato a polveri bianco o nero. Doppio diffusore: superiore in acrilico e inferiore con braccetto flessibile. Interruttori indipendenti incorporati. Presa USB.

LED Sorgente luminosa LED 3000 K, 20.000 h di durata.

ON OFF Lampada con interruttore integrato.

USB Lampada con presa USB integrata.

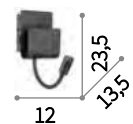

IP20

0,870 Kg / 0,0020 m³
LED 9W / 580 Lm

243160 € 120 **new**
237930 € 120 **new**



176536

Read

Montatura metallica verniciata a polveri.
Diffusore orientabile con LED integrato.
Presa USB.

LED Sorgente luminosa LED 3000 K,
15.000 h di durata.

ON/OFF Lampada con interruttore integrato.

USB Lampada con presa USB integrata.



176550



IP20

1,060 Kg / 0,0049 m³
LED 3W / 130 Lm

176536 € 107
176550 € 107



Book

Montatura metallica verniciata a polveri.
Diffusore in vetro satinato. Braccio flessibile gommato con LED. Doppio interruttore. Presa USB.

LED Sorgente luminosa LED 3000 K, 15.000 h di durata.

ON/OFF Lampada con interruttore integrato.

USB Lampada con presa USB integrata.

174972



IP20

1,570 Kg / 0,0148 m³
G9 max 1 x 28W +
LED 3W / 130 Lm

174792 € 130
174808 € 130



IP20

1,570 Kg / 0,0148 m³
G9 max 1 x 28W +
LED 3W / 130 Lm

174822 € 130
174846 € 130

3000 K / 300 Lm
209043 € 3,50

3000 K / 300 Lm
209043 € 3,50

Gim

Montatura in alluminio verniciato a polveri. Diffusore ruotabile con schermo acrilico satinato. Interruttore incorporato. LED integrati.

LED Sorgente luminosa LED 3000 K, 15.000 h di durata.

ON OFF Lampada con interruttore integrato.

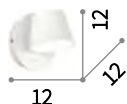

IP20

0,450 Kg / 0,0034 m³
LED 6W / 530 Lm

167152 € 60
167121 € 60



167121



167152

Hellen

Montatura in alluminio verniciato a polveri. Diffusore ruotabile con schermo acrilico satinato.

LED Sorgente luminosa LED 3000 K, 15.000 h di durata.

ON OFF Lampada con interruttore integrato.

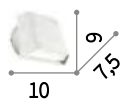

IP20

0,360 Kg / 0,0018 m³
LED 6W / 470 Lm

176628 € 60



Oby

Montatura in metallo verniciato bianco opaco, con snodi cromati. Corpo luce orientabile con diffusore in materiale plastico bianco.

LED Sorgente luminosa LED 3000 K, 20.000 h di durata.

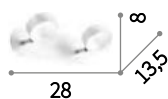

IP20

0,620 Kg / 0,0030 m³
LED 12W / 810 Lm

196695 € 95

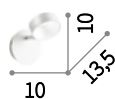

IP20

0,310 Kg / 0,0020 m³
LED 6W / 450 Lm

196688 € 48



P. 183

Lunare

Base e corpo luce interamente in metallo con finitura bianco. Cavo esterno rivestito da spirale metallica. Diffusori posizionabili.

Lightbulb icon Lampadine alogene GU10 28W 2700 K include.



IP20

0,880 Kg / 0,0071 m³
GU10 max 3 x 28W

077901 € 92



IP20

0,650 Kg / 0,0049 m³
GU10 max 2 x 28W

077895 € 70



IP20

0,250 Kg / 0,0020 m³
GU10 max 1 x 28W

077888 € 32



3000 K / 400 Lm
108292 € 3,50

3000 K / 400 Lm
108292 € 3,50

3000 K / 400 Lm
108292 € 3,50



P. 182



P. 648

Ciak

Montatura in metallo verniciato nero opaco. Diffusore posizionabile con alette mobili per l'orientamento del flusso luminoso.

 Lampadine alogene GU10 28W
2700 K incluse.

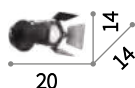

 IP20  INCLUSA

0,300 Kg / 0,0024 m³
GU10 max 1 x 50W

095653 ■ € 44

 3000 K / 400 Lm
108292 € 3,50



P. 188

Alfa

Montatura in metallo con finitura in cromo, brunito, bianco satinato o nickel satinato. Corpo luce posizionabile con rotazione dello stelo e snodo per l'inclinazione.

 Lampadine alogene GU10 28W
2700 K incluse.

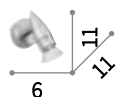
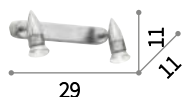

 IP20  INCLUSA  IP20  INCLUSA

0,390 Kg / 0,0023 m³
GU10 max 2 x 50W

0,170 Kg / 0,0009 m³
GU10 max 1 x 50W

122717 ■ € 30
089577 ■ € 30
009483 ■ € 30

099057 ■ € 16
089560 ■ € 16
009377 ■ € 16
119786 ■ € 18

 3000 K / 400 Lm
108292 € 3,50

 3000 K / 400 Lm
108292 € 3,50



P. 185



089560 009377 119786

Slem

Montatura in metallo con finitura in bianco, cromo o nickel satinato. Corpo luce posizionabile con rotazione dello stelo e snodo per l'inclinazione.

LED Lampadine LED GU10 7W 3000 K incluse. Cod.123943



018829

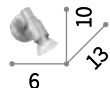
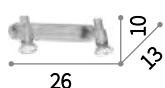

0,400 Kg / 0,0025 m³
GU10 max 2 x 50W

0,200 Kg / 0,0010 m³
GU10 max 1 x 50W

142081 € 32
142050 € 32
018836 € 32

099064 € 14
122984 € 14
018829 € 14

3000 K / 640 Lm
123943 € 3,90

3000 K / 640 Lm
123943 € 3,90



P. 186



099064 122984

Elis

Montatura in metallo cromato. Corpo luce orientabile. Diffusore in vetro pirex trasparente e smerigliato a sabbia nella parte centrale.

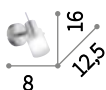
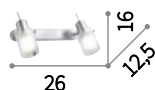
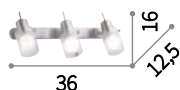

0,920 Kg / 0,0064 m³
E14 max 3 x 40W

0,650 Kg / 0,0049 m³
E14 max 2 x 40W

0,350 Kg / 0,0024 m³
E14 max 1 x 40W

031095 € 78

031088 € 52

031071 € 26

3000 K / 360 Lm
101217 € 3,00

3000 K / 360 Lm
101217 € 3,00

3000 K / 360 Lm
101217 € 3,00





P. 186

Nostalgia

Montatura in metallo cromato. Base con lastra in vetro bianco. Diffusori posizionabili in vetro trasparente stampato.

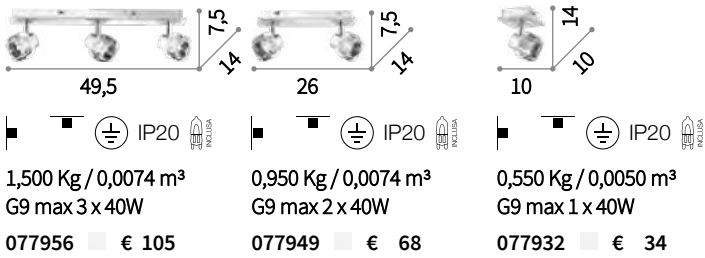
 Lampadine alogene G9 28W 2700 K incluse.



 3000 K / 300 Lm
209043 € 3,50

 3000 K / 300 Lm
209043 € 3,50

 3000 K / 300 Lm
209043 € 3,50

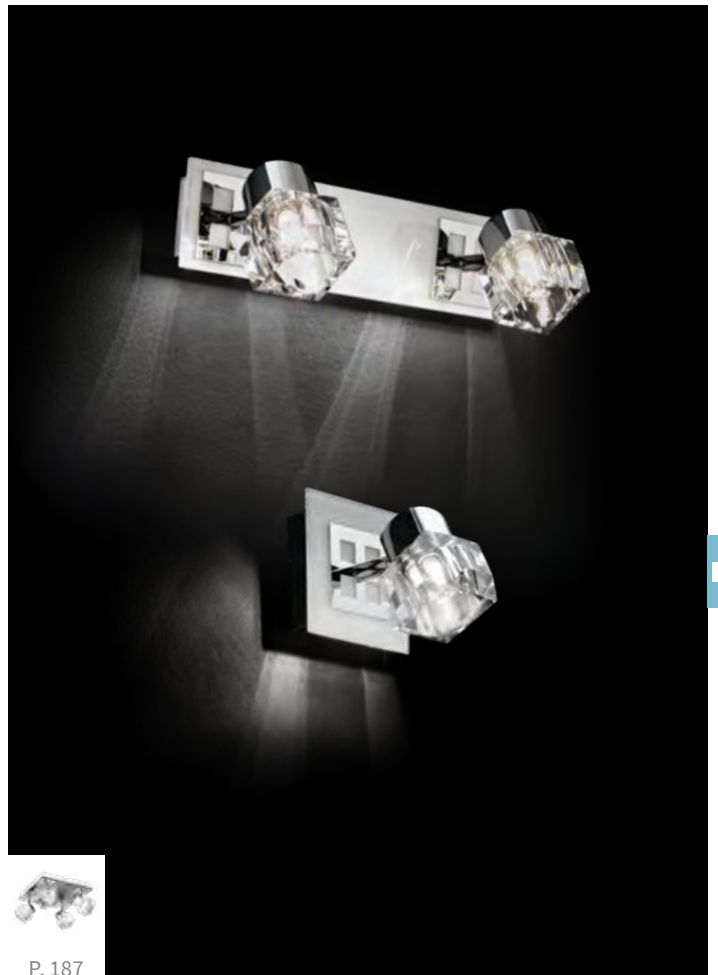

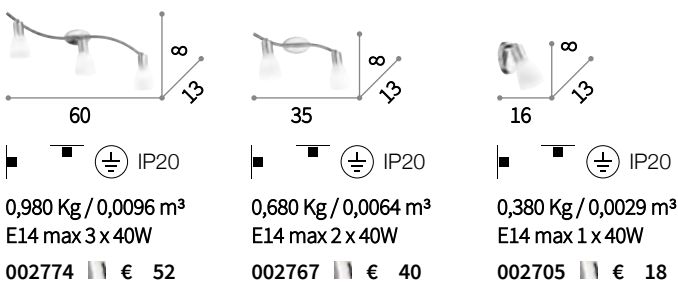

Snake

Montatura in metallo cromato. Corpo luce posizionabile. Diffusore in vetro bianco soffiato e acidato.



 3000 K / 360 Lm
101217 € 3,00

 3000 K / 360 Lm
101217 € 3,00

 3000 K / 360 Lm
101217 € 3,00



Moderno

Lampade da tavolo



Rain 262



Royal 262



Neve 263



Roma 263



Elica 264



Aladino 264



Smarties 265



Microphone 266



Mapa Max 267



Mapa 268



Penombra 269



Carta 269



Subway 270



Luxury 270



Woody 272



Hilton 272



Isa 273



Sheraton 273



Regol 274



London 275



Kalì 276



Lolita 277



Futura 278



Kelly 280



Sally 281



Wally 281



Gru 282



Studio 283



Birillo 286



Edo 287



Prato 287



Cupcake 288



Desiree 289



Candy 265



Luce Max 266



Basket 271



Nordik 271



York 276



Eminent 277



Air 284



Cerchio 285



Kalì

Pag 276

Rain

Montatura in metallo cromato. Pendagli con elementi in cristallo colorato e molato in varie forme e gocce finali.

ON OFF Lampada con interruttore integrato.

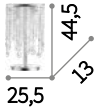

IP20

2,030 Kg / 0,0249 m³
E14 max 2 x 40W

008356 € 100
105284 € 133

3000 K / 430 Lm
101224 € 2,90

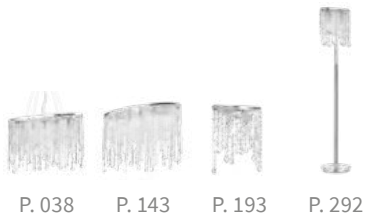

105284

Royal

Montatura circolare e portalampane in metallo cromato. Pendagli con elementi in cristallo molato ottagonali, quadrati, rettangolari e gocce finali.

LED Lampadine LED G9 3,2W 3000 K
includ. Cod. 209043

ON OFF Lampada con interruttore integrato.

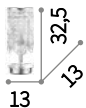

IP20

1,270 Kg / 0,0071 m³
G9 max 1x40W

053028 € 105

3000 K / 300 Lm
209043 € 3,50



P. 147



Neve

Montatura in metallo. Elementi decorativi con sfere di vetro fissate a fili di nylon. Disponibile con montatura cromata e sfere trasparenti.

LED Lampadine LED G9 3,2W 3000 K incluse. Cod. 209043

ON OFF Lampada con interruttore integrato.

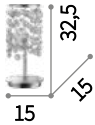

IP20
1,300 Kg / 0,0081 m³
G9 max 1x40W
033945 € 80



3000 K / 300 Lm
209043 € 3,50



P. 144

P. 194

Roma

Montatura e dettagli in metallo cromato. Diffusore con elementi quadrati in cristallo molato sulla fascia laterale e vetro sabbato sul fondo.

Lightbulb icon Lampadine alogene G9 28W 2700 K incluse.

ON OFF Lampada con interruttore integrato.

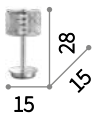

IP20
1,930 Kg / 0,0182 m³
G9 max 1x40W
114620 € 107



3000 K / 300 Lm
209043 € 3,50



P. 041

P. 150

P. 196

Elica

Montatura in nickel satinato. Diffusore in vetro bianco soffiato, incamiciato e acidato.

 Lampada con interruttore integrato.

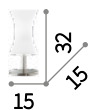

 IP20

1,730 Kg / 0,0229 m³
E14 max 1 x 40W

014593 € 93

 3000 K / 360 Lm
101217 € 3,00



Aladino

Montatura in metallo smaltato bianco satinato. Diffusore in vetro soffiato incamiciato acidato.

 Lampada con interruttore integrato.



 IP20

3,630 Kg / 0,0722 m³
G9 max 3 x 40W

137285 € 204

 3000 K / 300 Lm
209043 € 3,50



Smarties

Montatura in metallo. Diffusore in vetro bianco soffiato e acidato.

LED Lampadine LED G9 3,2W 3000 K
includ. Cod. 209043

**ON
OFF** Lampada con interruttore integrato.

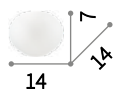

IP20  

0,470 Kg / 0,0079 m³
G9 max 1x40W

032078 € 40



 3000 K / 300 Lm
209043 € 3,50



P. 090



P. 158



P. 203

Candy

Montatura in metallo con finitura nickel satinato. Diffusore in vetro bianco soffiato e acidato.

LED Lampadine LED G9 3,2W 3000 K
includ. Cod. 209043

**ON
OFF** Lampada con interruttore integrato.

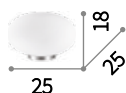

IP20  

1,200 Kg / 0,0287 m³
G9 max 1x40W

086804 € 70



 3000 K / 300 Lm
209043 € 3,50



P. 092



P. 161

Luce Max

Montatura in cromo. Diffusore in vetro soffiato con decorazione interna in filo d'alluminio.

ON OFF Lampada con interruttore integrato.

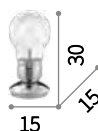

IP20

1,240 Kg / 0,0271 m³

E27 max 1 x 60W

033686 € 46



3000 K / 860 Lm
119571 € 6,50



P. 097

Microphone ^{new}

Base e montatura in metallo verniciato a polveri bianco, nero o placcato ottone. Cavo rivestito in tessuto con interruttore incorporato.

LED Lampadine LED E27 8W Globo D95 3000 K incluse. Cod. 101323

ON OFF Lampada con interruttore integrato.



IP20

0,490 Kg / 0,0042 m³

E27 max 1 x 60W

232508 € 55 ^{new}

232546 € 65 ^{new}

232485 € 55 ^{new}

3000 K / 860 Lm
101323 € 7,90



P. 313





Mapa Max

Montatura in cromo. Diffusore in vetro soffiato con decorazione interna in filo d'alluminio.

ON
OFF Lampada con interruttore integrato.

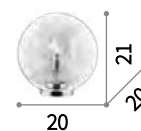

 IP20

0,970 Kg / 0,0287 m³
E27 max 1x60W

045139 € 56



P. 101



3000 K / 860 Lm
119571 € 6,50



Mapa

Montatura in metallo cromato o bianco.
Diffusore a sfera in vetro bianco soffiato e acidato, con decorazione dipinta o in vetro trasparente cromato con sfumatura verso il basso.

ON OFF Lampada con interruttore integrato.



161433

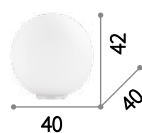

IP20

3,520 Kg / 0,1354 m³
E27 max 1x60W

000206 € 146

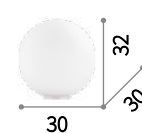

IP20

1,880 Kg / 0,0515 m³
E27 max 1x60W

009131 € 68

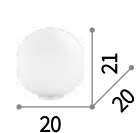

IP20

1,050 Kg / 0,0214 m³
E27 max 1x60W

009155 € 42
161433 € 56
186863 € 78



P. 102 P. 162 P. 204

3000 K / 860 Lm
119571 € 6,50

3000 K / 860 Lm
119571 € 6,50

3000 K / 860 Lm
119571 € 6,50

Penombra

Montatura e vela superiore in metallo rifinito in ottone. Diffusore in vetro bianco soffiato e acidato.

 Lampada con interruttore integrato.

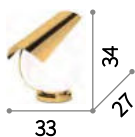

 IP20

2,550 Kg / 0,0488 m³

E27 max 1 x 60W

176680  € 150

 3000 K / 720 Lm
123899 € 6,90



P. 107

P. 204



Carta ^{new}

Montatura in metallo verniciato bianco opaco. Diffusore in policarbonato con rivestimento ad effetto carta. Cavo rivestito in tessuto.

 Lampada con interruttore integrato.

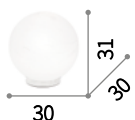

 IP20

1,500 Kg / 0,0400 m³

E27 max 1 x 25W

226057  € 90 ^{new}





 IP20

0,510 Kg / 0,0155 m³

E27 max 1 x 25W

248417  € 60 ^{new}

 3000 K / 720 Lm
123899 € 6,90

 3000 K / 720 Lm
123899 € 6,90



P. 105



Subway ^{new}

Montatura in metallo verniciato bianco opaco. Diffusore cilindrico in vetro bianco. Cavi elettrici in pvc trasparente.

LED Sorgente luminosa LED 3000 K, 20.000 h di durata.

ON OFF Lampada con interruttore integrato.

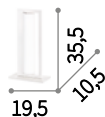

IP20

1,720 Kg / 0,0560 m³
LED 8W / 560 Lm

224473 € 100 ^{new}



Luxury

Montatura in metallo rifinita in ottone o cromo. Base nera opaca. Paralume in pvc con bordi in tessuto.

ON OFF Lampada con interruttore integrato.

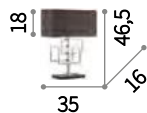

IP20

2,890 Kg / 0,0333 m³
E27 max 1 x 60W

201078 € 236
201115 € 246



201115



201054

3000 K / 860 Lm
119571 € 6,50

Basket

Montatura in metallo cromato. Diffusore in spago ignifugo.

ON
OFF Lampada con interruttore integrato.

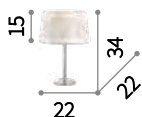

IP20

1,200 Kg / 0,0224 m³
E27 max 1 x 60W

082387 € 74

3000 K / 720 Lm
123899 € 6,90



Nordik

Montatura in metallo verniciato nero opaco. Paralume in lamina di PVC dorato rivestito in tessuto nero.

ON
OFF Lampada con interruttore integrato.

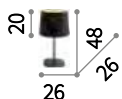

IP20

1,220 Kg / 0,0504 m³
E27 max 1 x 60W

161686 € 83

3000 K / 860 Lm
119571 € 6,50



Woody

Montatura in metallo cromato. Diffusore in PVC o in tessuto.

LED Lampadine LED G9 3,2W 3000 K incluse. Cod. 209043

ON OFF Lampada con interruttore integrato.

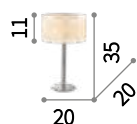

IP20 INCLUSA

0,780 Kg / 0,0121 m³
G9 max 1x40W

143187 € 65
087672 € 65



 3000 K / 300 Lm
209043 € 3,50



Hilton

Montatura in cromo. Paralume in lamina di PVC rivestita in tessuto. Sul fondo, diffusore in vetro trasparente sabbato.

LED Lampadine LED G9 3,2W 3000 K incluse nel modello 075525. Cod. 209043

ON OFF Lampada con interruttore integrato.

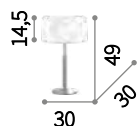

IP20
2,180 Kg / 0,0431 m³
E14 max 2 x 40W

075532 € 120

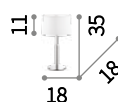

IP20 INCLUSA
0,830 Kg / 0,0109 m³
G9 max 1 x 40W

075525 € 80



 3000 K / 360 Lm
101217 € 3,00

 3000 K / 300 Lm
209043 € 3,50



Isa

Montatura in metallo cromato. Paralumi in lamina di pvc trasparente avvolto da nastri in tessuto leggero di colore bianco. Diffusore in vetro trasparente sabbiato.

LED Lampadine LED G9 3,2W 3000 K incluse. Cod. 209043

ON/OFF Lampada con interruttore integrato.

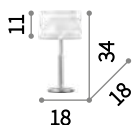

IP20

0,850 Kg / 0,0098 m³
G9 max 1x40W

016559 € 74

3000 K / 300 Lm
209043 € 3,50



Sheraton

Montatura in metallo cromato. Paralumi in lamina di PVC rivestita di tessuto.

LED Lampadine LED G9 3,2W 3000 K incluse. Cod. 209043

ON/OFF Lampada con interruttore integrato.



IP20

0,800 Kg / 0,0096 m³
G9 max 1x40W

075013 € 75

3000 K / 300 Lm
209043 € 3,50





Regol

Montatura snodata in metallo. Diffusore regolabile ad altezze diverse. Disponibile con finitura nickel satinato e paralume rivestito in tessuto bianco o con finitura cromo e paralume in PVC cromato.

ON
OFF Lampada con interruttore integrato.

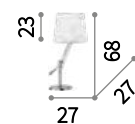

IP20

2,880 Kg / 0,0398 m³
E27 max 1x60W

014616 € 130
019772 € 158



P. 304

3000 K / 860 Lm
119571 € 6,50



London

Montatura in metallo rifinito in cromo, ottone o con vernice opaca bianca o nera. Paralume in lamina di PVC rivestito di tessuto, per la versione cromo in lamina di PVC cromata e semi trasparente.

ON
OFF Lampada con interruttore integrato.

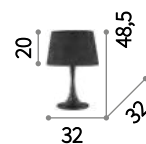

IP20

1,910 Kg / 0,0645 m³
E27 max 1 x 60W

110448 € 90
032375 € 97
110455 € 90

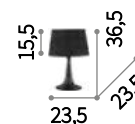

IP20

1,270 Kg / 0,0253 m³
E27 max 1 x 60W

110530 € 56
032368 € 65
110554 € 56

3000 K / 860 Lm
119571 € 6,50

3000 K / 860 Lm
119571 € 6,50

Kali **new**

Corpo luce in ceramica con decori in rilievo. Paralume in pvc rivestito con tessuto. Cavo in pvc con interruttore integrato.

ON
OFF Lampada con interruttore integrato.

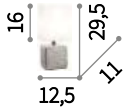

IP20

0,620 Kg / 0,0036 m³
E14 max 1 x 40W

245348 € 20 **new**



IP20

0,660 Kg / 0,0092 m³
E14 max 1 x 40W

245331 € 20 **new**



IP20

0,600 Kg / 0,0055 m³
E14 max 1 x 40W

245393 € 20 **new**



245331

245393

245348

3000 K / 360 Lm
101217 € 3,00

3000 K / 360 Lm
101217 € 3,00

3000 K / 360 Lm
101217 € 3,00

York

Base in legno naturale con dettagli in metallo. Paralume in lamina di pvc rivestito in tessuto. Cavo esterno in tessuto. Disponibile anche con montatura e paralume bianchi o neri.

ON
OFF Lampada con interruttore integrato.

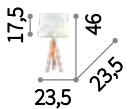

IP20

0,500 Kg / 0,0172 m³
E27 max 1 x 60W

121376 € 90

089782 € 90

121413 € 90



P. 317



121413

121376

089782

3000 K / 860 Lm
119571 € 6,50

Eminent ^{new}

Montatura in metallo verniciato a polveri di colore bianco o nero. Asta in legno naturale. Paralume in pvc rivestito con tessuto. Cavo rivestito in tessuto con interruttore.

ON OFF Lampada con interruttore integrato.

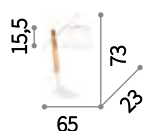

IP20

1,970 Kg / 0,0275 m³
E27 max 1 x 60W

207568 ■ € 120 ^{new}
238388 ■ € 120 ^{new}

 3000 K / 720 Lm
123899 € 6,90

P. 302



238388



207568

Lolita ^{new}

Lampada da tavolo a batteria ricaricabile con finitura bianca o nera. Montatura in metallo. Diffusore in materiale plastico. Autonomia di 5 ore.

LED Sorgente luminosa LED 3000 K, 25.000 h di durata.

ON OFF Lampada con interruttore integrato.

IP44 Grado di protezione IP44.

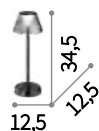

IP44

0,530 Kg / 0,0078 m³
LED 7W / 450 Lm

250281 ■ € 68 ^{new}
250274 ■ € 68 ^{new}



250274



250281



Futura

Braccio in alluminio e plastica, snodato con cavo a vista in pvc. Diffusore orientabile a led e interruttore incorporato. Spina con alimentatore.

LED Sorgente luminosa LED 4000 K, 25.000 h di durata.

ON OFF Lampada con interruttore integrato.

+ Lampada con dimmer.

Hand Lampada con dimmer tattile.

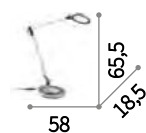

1,830 Kg / 0,0069 m³
LED 10W / 600 Lm

204895 ■ € 115
204888 ■ € 115



P. 310



204888



108117

Kelly

Lampada tecnica in metallo con finitura bianco o nero opaco. Braccio snodato e bilanciato a molle. Diffusore orientabile.

ON
OFF Lampada con interruttore integrato.



108094

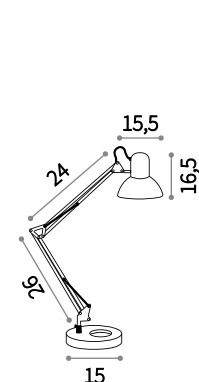

IP20

1,430 Kg / 0,0065 m³
E27 max 1 x 42W

108117 € 34
108094 € 34

3000 K / 360 Lm
101286 € 3,00

Sally

Lampada tecnica in metallo con finitura nero opaco. Braccio snodato e bilanciato a molle. Diffusore orientabile.



Lampada con interruttore integrato.

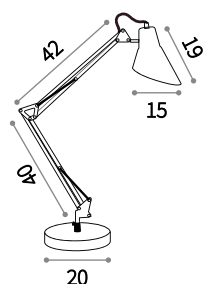

IP20

2,600 Kg / 0,0132 m³
E27 max 1x42W

061160 ■ € 75



3000 K / 720 Lm
123899 € 6,90



Wally

Lampada tecnica in metallo con finitura nero opaco. Braccio snodato e bilanciato a molle. Diffusore orientabile.



Lampada con interruttore integrato.

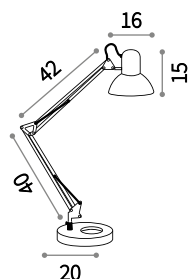

IP20

2,450 Kg / 0,0111 m³
E27 max 1x42W

061191 ■ € 72



3000 K / 360 Lm
101286 € 3,00





147659

Gru

Montatura interamente in metallo. Asta con finitura in cromo. Base e diffusore con finitura in alluminio anodizzato o in vernice opaca bianca o nera. Diffusore ruotabile e regolabile in altezza.

LED Sorgente luminosa LED 3000 K, 15.000 h di durata.

ON OFF Lampada con interruttore integrato.

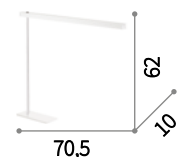

IP20

2,220 Kg / 0,0084 m³
LED 6,3W / 400 Lm

147642 € 165
147635 € 165
147659 € 165



Studio

Montatura in metallo. Diffusore in vetro soffiato incamiciato. Accensione e regolazione di intensità con dispositivo touch attivo su tutta la montatura.



Lampadine alogene G9 28W 2700 K incluse.



Lampada con interruttore integrato.



Lampada con dimmer.



Lampada con dimmer tattile.

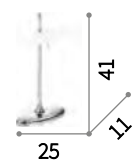

1,200 Kg / 0,0280 m³
G9 max 2 x 28W

010069 € 108



3000 K / 300 Lm
209043 € 3,50



Air

Corpo luce in metallo verniciato a polveri.
Diffusore in materiale acrilico. Cavo con
alimentatore e interruttore. Led integrato.

LED Sorgente luminosa LED 3000 K,
20.000 h di durata.

ON
OFF Lampada con interruttore integrato.

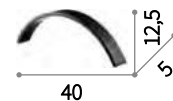

IP20

0,480 Kg / 0,0056 m³
LED 10W / 720 Lm

207766 € 85
207780 € 85



Cerchio **new**

Corpo luce in metallo verniciato bianco o nero opaco. Diffusore in materiale plastico colore opale. Cavo in pvc con interruttore e alimentatore incorporati.

LED Sorgente luminosa LED 3000 K, 20.000 h di durata.

ON/OFF Lampada con interruttore integrato.

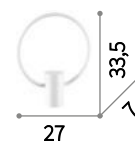

IP20

0,910 Kg / 0,0145 m³
LED 12W / 470 Lm

224633 **€ 115 new**
224640 **€ 115 new**



116570

Birillo

Lampada da tavolo o da terra con base in metallo cromato e diffusore in vetro soffiato bianco e acidato o fumè.

ON
OFF Lampada con interruttore integrato.



000251

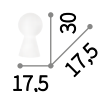

IP20

IP20

IP20

3,550 Kg / 0,0945 m³
E27 max 1 x 60W

2,310 Kg / 0,0454 m³
E27 max 1 x 60W

1,240 Kg / 0,0248 m³
E27 max 1 x 60W

000275 € 194
116594 € 255

000251 € 120
116587 € 145

000268 € 75
116570 € 80

3000 K / 860 Lm
119571 € 6,50

3000 K / 860 Lm
119571 € 6,50

3000 K / 860 Lm
119571 € 6,50

Edo

Montatura interna in metallo cromato.
Diffusore in vetro bianco soffiato,
incamiciato e acidato.

 Lampada con interruttore integrato.

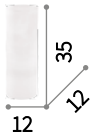

 IP20

1,150 Kg / 0,0172 m³
E27 max 1 x 60W

044590 € 50

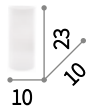

 IP20

0,730 Kg / 0,0082 m³
E27 max 1 x 60W

044606 € 37

 3000 K / 720 Lm
123899 € 6,90

 3000 K / 360 Lm
101286 € 3,00



Prato

Diffusore in vetro soffiato bianco
incamiciato e acidato.

 Lampada con interruttore integrato.

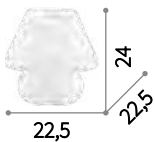

 IP20

1,380 Kg / 0,0219 m³
E27 max 1 x 60W

074702 € 57

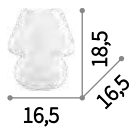

 IP20

0,650 Kg / 0,0099 m³
E14 max 1 x 40W

074726 € 36

 3000 K / 360 Lm
101286 € 3,00

 3000 K / 360 Lm
101217 € 3,00





194448

Cupcake **new**

Base in resina smaltata bianca o rosa.
Diffusore in vetro bianco soffiato e acidato.
Cavo di alimentazione con interruttore.

LED

Lampadine LED GX53 9,5W
3000 K incluse nei modelli: 248479 e
248486. Cod. 123936

**ON
OFF**

Lampada con interruttore integrato.



194417



IP20

4,290 Kg / 0,0695 m³
E27 max 1 x 60W

194417 € 150
194448 € 150

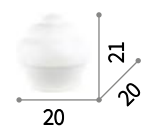

IP20

1,120 Kg / 0,0270 m³
GX53 max 1 x 15W

248479 € 75 **new**
248486 € 75 **new**

 3000 K / 720 Lm
123899 € 6,90

 3000 K / 760 Lm
123936 € 5,90





Desiree

Montatura e base in metallo cromato.
Paralume in lamina di PVC rivestita in
tessuto.

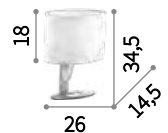
 Lampada con interruttore integrato.



 IP20
0,920 Kg / 0,0130 m³
E14 max 1 x 40W
074870 ■ € 105

 3000 K / 360 Lm
101217 ■ € 3,00

Moderno

Lampade da terra



Rain 292



Elica 292



Luxury 293



Phoenix 293



Cylinder 294



Nordik 294



Basket 295



Sheraton 297



Dorsale 298



Daddy 300



Pagoda 301



Eminent 302



Colonna 306



Stand Up 307



Mallow 308



Subway 308



Polly 309



Futura 310



Radio 311



Stage 315



Tridente 316



York 317



Klimt 318



Fit 319



Woody 296



Hilton 296



Isa 297



Piano 303



Regol 304



London 305



Minimal 312



Microphone 313



Movie 314

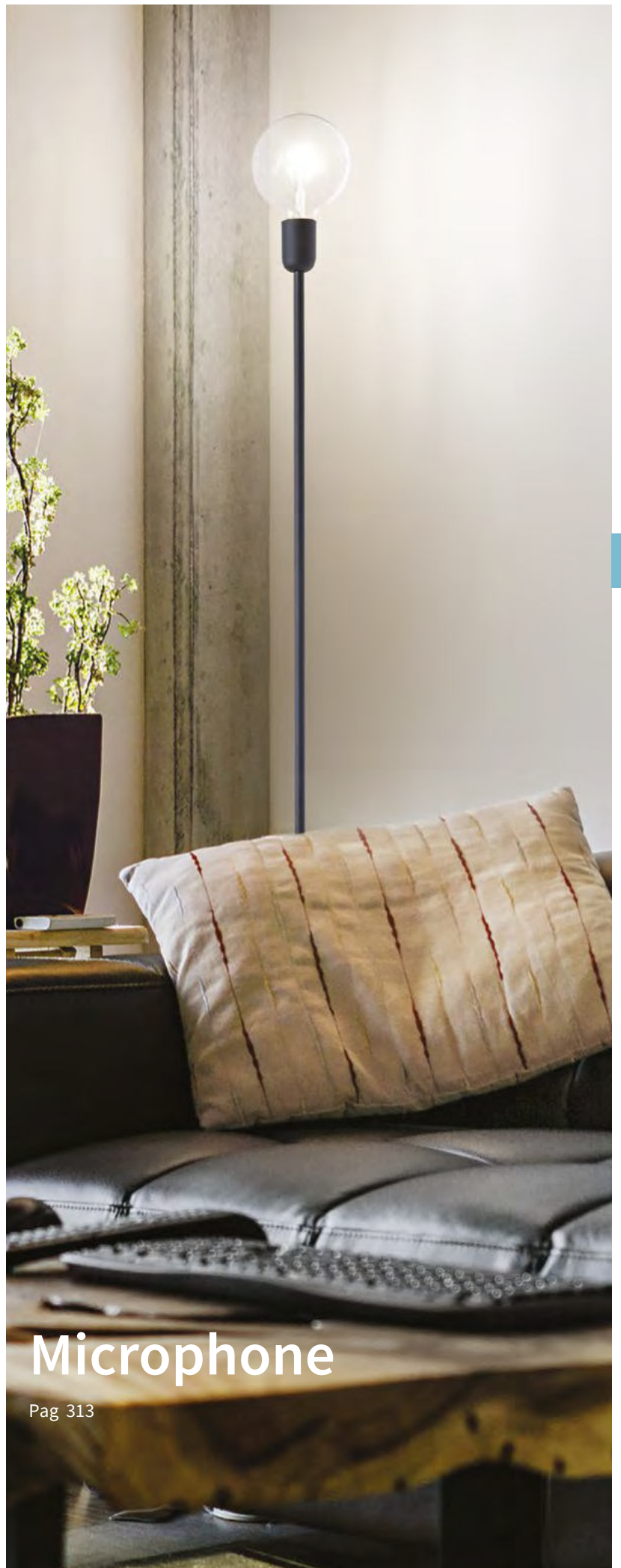

Microphone

Pag 313

Rain

Montatura in metallo cromato. Pendagli con elementi in cristallo colorato e molato in varie forme e gocce finali.

ON
OFF Lampada con interruttore integrato.

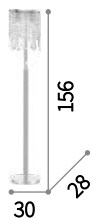

IP20

5,300 Kg / 0,0450 m³

E14 max 2 x 40W

080277 € 270



3000 K / 430 Lm
101224 € 2,90



P. 038



P. 143



P. 193



P. 262



Elica

Montatura in nickel satinato. Diffusore in vetro bianco soffiato, incamiciato e acidato.

ON
OFF Lampada con interruttore integrato.

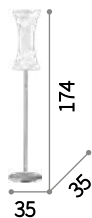

IP20

9,700 Kg / 0,1303 m³

E27 max 1 x 60W

017587 € 340



3000 K / 720 Lm
123899 € 6,90



P. 202



P. 264



Luxury

Montatura in metallo rifinita in ottone o cromo. Base nera opaca. Paralume in pvc con bordi in tessuto.



Lampada con interruttore integrato.

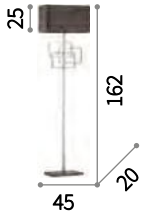

IP20

7,440 Kg / 0,2321 m³
E27 max 1 x 60W

201085 € 470
201122 € 492



3000 K / 860 Lm
101347 € 8,90



P. 118



P. 205



P. 270

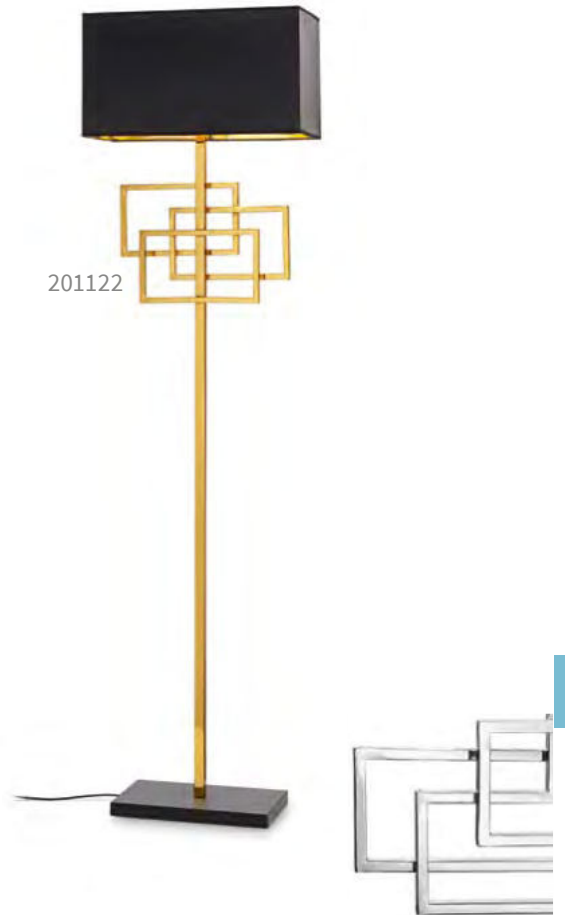

201122



201085

Phoenix

Montatura in metallo cromato. Paralume con telaio in metallo e rivestimento in tessuto. Elementi decorativi con catene di ottagoni in cristallo molato.



Lampada con interruttore integrato.

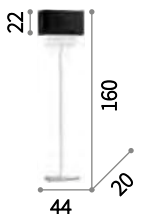

IP20

6,000 Kg / 0,1582 m³
E27 max 1 x 60W

115719 € 330
113692 € 330



3000 K / 720 Lm
101354 € 9,00



P. 119



P. 163



P. 205



115719



113692

Cylinder

Montatura in metallo. Diffusore in vetro soffiato bianco acidato.

 Lampada con interruttore integrato.

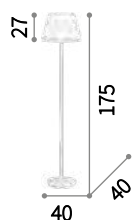

 IP20

10,010 Kg / 0,1145 m³
E27 max 2 x 60W

111452  € 200

 3000 K / 720 Lm
123899 € 6,90



P. 080



Nordik

Montatura in metallo verniciato nero opaco. Paralume in lamina di PVC dorato rivestito in tessuto nero.

 Lampada con interruttore integrato.

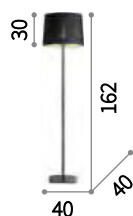

 IP20

3,620 Kg / 0,0897 m³
E27 max 1 x 60W

161716  € 173

 3000 K / 860 Lm
101347 € 8,90



P. 124



P. 206



P. 271





Basket

Montatura in metallo cromato. Diffusore in spago ignifugo.

ON
OFF Lampada con interruttore integrato.



IP20
8,270 Kg / 0,0990 m³
E27 max 1x60W
082448 € 220



P. 122



P. 206



P. 271



3000 K / 720 Lm
101354 € 9,00

Woody

Montatura in metallo cromato. Diffusore in PVC o in tessuto, chiuso sul fondo da vetro trasparente acidato.



Lampada con interruttore integrato.

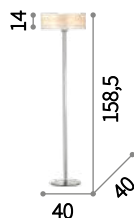

IP20

4,800 Kg / 0,0749 m³
E14 max 2 x 40W

143163 € 215
087689 € 215

3000 K / 360 Lm
101217 € 3,00



Hilton

Montatura in cromo. Paralume in lamina di PVC rivestita in tessuto. Sul fondo, diffusore in vetro trasparente sabbaiato.



Lampada con interruttore integrato.

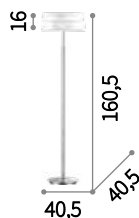

IP20

6,600 Kg / 0,0739 m³
E14 max 2 x 40W

075488 € 210

3000 K / 360 Lm
101217 € 3,00



Isa

Montatura in metallo cromato. Paralumi in lamina di pvc trasparente avvolto da nastri in tessuto leggero di colore bianco. Diffusore in vetro trasparente sabbaiato.

 Lampada con interruttore integrato.

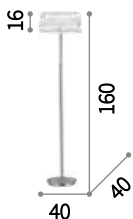

 IP20

6,300 Kg / 0,0693 m³

E14 max 2 x 40W

018546 € 210

 3000 K / 360 Lm
101217 € 3,00



P. 128



P. 273



Sheraton

Montatura in metallo cromato. Paralumi in lamina di PVC rivestita di tessuto.

 Lampada con interruttore integrato.

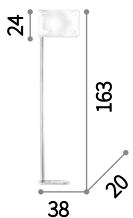

 IP20

4,980 Kg / 0,0376 m³

E27 max 1 x 60W

074931 € 195

 3000 K / 720 Lm
101354 € 9,00



P. 130



P. 210



P. 273



Dorsale

Montatura in metallo rifinito in cromo o con vernice opaca bianca o nera. Braccio a sezione quadrata composto da tre elementi. Paralume in lamina di PVC, disponibile in colore cromo o rivestita in tessuto bianco o nero.

ON
OFF Lampada con interruttore integrato.



014371



005126

012605

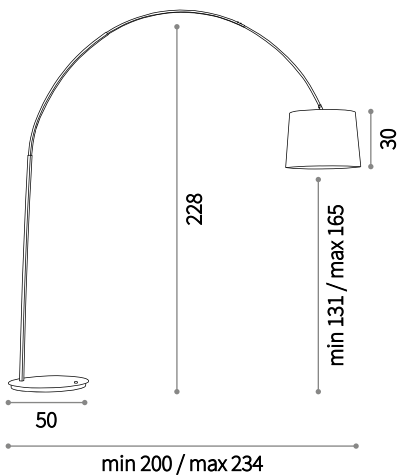

IP20

12,430 Kg / 0,1565 m³
E27 max 1 x 60W

095127 € 520
012605 € 565
005126 € 590
091983 € 520
014371 € 565

3000 K / 860 Lm
101347 € 8,90



095127

091983



110363

Daddy

Montatura in metallo. Disponibile in nero e bianco opaco con paralume rivestito in tessuto o in cromo con paralume in lamina di pvc cromata semitrasparente.

ON **OFF** Lampada con interruttore integrato.



110356

110370

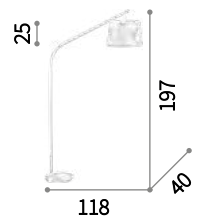

IP20

7,250 Kg / 0,1287 m³
E27 max 1x60W

110356 € 250
110370 € 315
110363 € 250

3000 K / 860 Lm
101347 € 8,90



Pagoda

Montatura e base in metallo rifinito con smalto satinato. Paralume a inclinazione regolabile rivestito di tessuto.

ON
OFF Lampada con interruttore integrato.

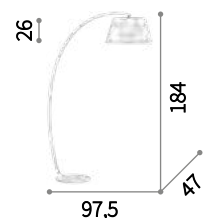

IP20

11,620 Kg / 0,1755 m³
E27 max 1x60W

051741 € 298
062273 € 298
051765 € 298

3000 K / 860 Lm
101347 € 8,90



207582

Eminent **new**

Montatura in metallo verniciato a polveri di colore bianco o nero. Asta in legno naturale. Paralume in pvc rivestito con tessuto. Cavo rivestito in tessuto con interruttore.

ON
OFF Lampada con interruttore integrato.



207599

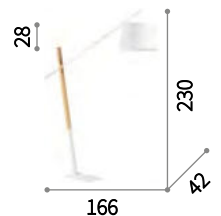

IP20

10,610 Kg / 0,1120 m³
E27 max 1x60W

207582 € 398
207599 € 398 **new**



P. 277

3000 K / 720 Lm
101354 € 9,00



145365

Piano

Montatura e diffusore in metallo rifinito con vernice opaca bianca o nera. Tavolino di supporto in legno naturale tornito.



Lampada con interruttore integrato.



138282

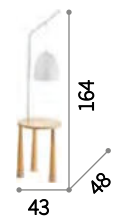

IP20

6,250 Kg / 0,1553 m³
E27 max 1x60W

138282 ■ € 408
145365 ■ € 408

3000 K / 720 Lm
101330 € 8,50



Regol

Montatura snodata in metallo. Diffusore regolabile ad altezze diverse. Disponibile con finitura nickel satinato e paralume rivestito in tessuto bianco.

ON
OFF Lampada con interruttore integrato.

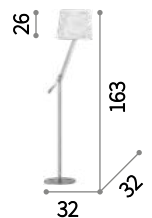

IP20

5,420 Kg / 0,0702 m³
E27 max 1x60W

014609 € 200



P. 274



3000 K / 860 Lm
101347 € 8,90



110257

London

Montatura in metallo rifinito in cromo, ottone o con vernice opaca bianca o nera. Paralume in lamina di PVC rivestito di tessuto, per la versione cromo in lamina di PVC cromata e semi trasparente.

ON
OFF Lampada con interruttore integrato.

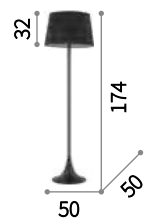

IP20

7,120 Kg / 0,1879 m³
E27 max 1x100W

110233 € 223
032382 € 240
110257 € 246
110240 € 223



P. 123



P. 275



3000 K / 860 Lm
101347 € 8,90



Colonna

Montatura in metallo cromato o verniciato bianco o nero opaco. Diffusore in acrilico. Cavo in tessuto. Lampadine a LED sostituibili.

LED Lampadine LED GX53 9,5W 3000 K incluse. Cod. 123936

ON/OFF Lampada con interruttore integrato.

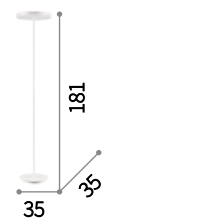
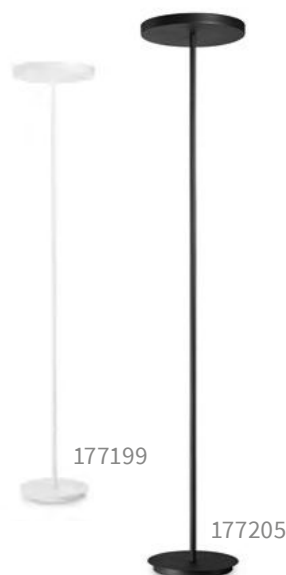

IP20

7,740 Kg / 0,0710 m³
GX53 max 4 x 15W

177199 € 270
177212 € 305
177205 € 270

3000 K / 760 Lm
123936 € 5,90



Stand Up

Montatura in metallo con finitura in cromo. Diffusore in vetro pirex smerigliato nella parte centrale.

LED Lampadine LED R7s 10W 118 mm 3000 K incluse. Cod. 189093

ON OFF Lampada con interruttore integrato.

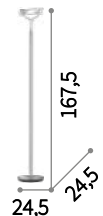

4,130 Kg / 0,0233 m³
R7s max 1 x 150W
027289 € 143

3000 K / 1200 Lm
189093 € 17,00

Mallow

Base e bracci in metallo con finitura in vernice opaca bianca. Diffusori in vetro trasparente soffiato e sabbato.

 Lampadine alogene G9 28W 2700 K incluse.

 Lampada con interruttore integrato.



 IP20 

5,690 Kg / 0,1808 m³
G9 max 6x28W

174426 € 400



P. 170



Subway ^{new}

Montatura in metallo verniciato bianco opaco. Diffusore cilindrico in vetro bianco. Cavi elettrici in pvc trasparente.

 Sorgente luminosa LED 3000 K, 20.000 h di durata.

 Lampada con interruttore integrato.

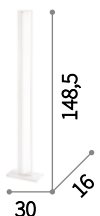

 IP20

7,370 Kg / 0,0588 m³
LED 27W / 2530 Lm

224466 € 350 ^{new}



P. 114

P. 236

P. 270





Polly

Diffusori e base in metallo cromato o smaltato bianco o nero. Dettagli e raccordi in metallo cromato. Diffusori orientabili.



Lampada con interruttore integrato.

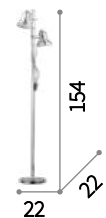

IP20

3,500 Kg / 0,0207 m³
E27 max 2x60W

061122 € 87
061115 € 87
061139 € 87



3000 K / 860 Lm
119571 € 6,50

Futura

Braccio in alluminio e plastica, snodato con cavo a vista in pvc. Diffusore orientabile a led e interruttore incorporato. Spina con alimentatore.

LED Sorgente luminosa LED 4000 K, 25.000 h di durata.

ON OFF Lampada con interruttore integrato.

+ Lampada con dimmer.

☞ Lampada con dimmer tattile.

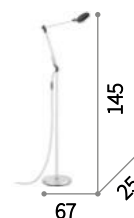

4,440 Kg / 0,0095 m³
LED 10W / 600 Lm

204956 ■ € 155
204949 ■ € 155



P. 278



119458

Radio

Rosone e montatura in metallo. Diffusore posizionabile. Cavo elettrico in tessuto. Disponibile con finitura in cromo o con vernice opaca bianca.

LED Lampadine LED E27 8W Globo D125 trasparente 3000 K incluse. Cod. 101347

ON OFF Lampada con interruttore integrato.



P. 056



P. 198



119410

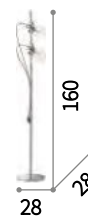

IP20

6,270 Kg / 0,0428 m³
E27 max 2 x 60W

119458 € 156
119410 € 195

3000 K / 860 Lm
101347 € 8,90



Minimal

Montatura in metallo rifinito in cromo
o in smalto colorato nero. Cavo elettrico
con rivestimento in tessuto.

LED

Lampadine LED E27 8W Globo D125
trasparente 3000 K incluse.
Cod. 101347

**ON
OFF**

Lampada con interruttore integrato.

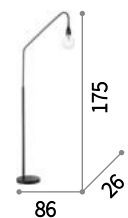

IP20  

5,840 Kg / 0,0806 m³
E27 max 1 x 60W

163369 ■ € 144



P. 057

P. 199

 3000 K / 860 Lm
101347 € 8,90



232331

Microphone ^{new}

Base e montatura in metallo verniciato a polveri bianco, nero o placcato ottone. Cavo rivestito in tessuto con interruttore incorporato.

LED

Lampadine LED E27 8W Globo D125 trasparente 3000 K incluse.
Cod. 101347

**ON
OFF**

Lampada con interruttore integrato.



P. 266

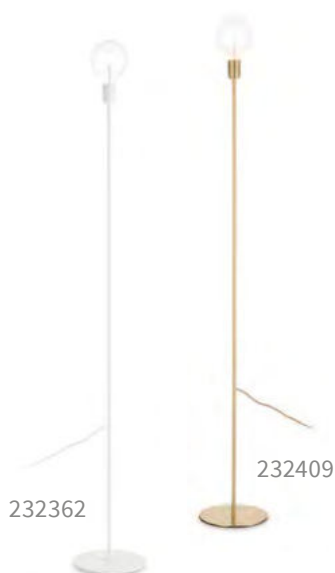

232362

232409

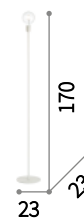

IP20  

2,320 Kg / 0,0425 m³
E27 max 1x60W

232362 € 125 ^{new}

232409 € 150 ^{new}

232331 € 125 ^{new}

 3000 K / 860 Lm
101347 € 8,90



Movie

Montatura interamente in metallo verniciato nero opaco. Diffusore orientabile con alette mobili per la regolazione del flusso luminoso.

ON **OFF** Lampada con interruttore integrato.

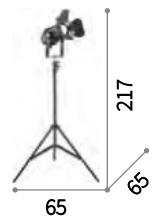

IP20

1,980 Kg / 0,0186 m³
E27 max 1x60W

138527 ■ € 392



P. 188

3000 K / 720 Lm
101330 € 8,50



Stage

Corpo luce in metallo rifinito con vernice nera opaca. Treppiede con asta telescopica regolabile in altezza. Diffusore orientabile, decorato internamente in foglia argento o in foglia oro.

ON
OFF Lampada con interruttore integrato.

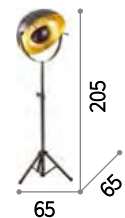

IP20

5,540 Kg / 0,1163 m³
E27 max 1x60W

132785 € 324
132778 € 324

3000 K / 860 Lm
119571 € 6,50



Tridente

Treppiede in legno naturale. Paralume in lamina di pvc rivestita in tessuto e con supporto in metallo con finitura nickel satinato.

ON
OFF Lampada con interruttore integrato.

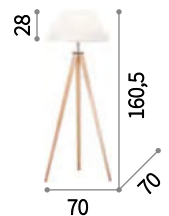

IP20

3,080 Kg / 0,1476 m³
E27 max 1x60W

146317 € 335

3000 K / 720 Lm
101354 € 9,00



089805

York

Base in legno naturale con dettagli in metallo. Paralume in lamina di pvc rivestito in tessuto. Cavo esterno in tessuto. Disponibile anche con montatura e paralume bianchi o neri.

ON **OFF** Lampada con interruttore integrato.



P. 276

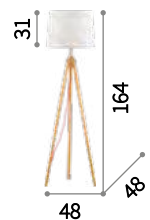

IP20

2,810 Kg / 0,0947 m³
E27 max 1x60W

121406 € 175
089805 € 175
121437 € 175

3000 K / 860 Lm
101347 € 8,90



Klimt

Treppiede in legno naturale. Paralume in lamina di pvc rivestita in tessuto e con supporto in metallo cromato.

ON
OFF Lampada con interruttore integrato.

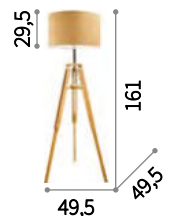

IP20

3,870 Kg / 0,1284- m³
E27 max 1x60W

137827 € 330

3000 K / 860 Lm
101347 € 8,90



220963

Fit

Base in metallo verniciato opaco.
Paralume con tessuto naturale
intercambiabile e lavabile. Due tessuti
inclusi: bianco/nero e canvas.

ON
OFF Lampada con interruttore integrato.



197036

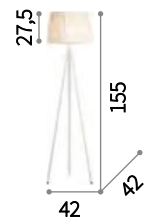

IP20

2,500 Kg / 0,0969 m³
E27 max 1 x 60W

197036 € 260
220963 € 260

3000 K / 720 Lm
101354 € 9,00

Classico

Lampade a sospensione



Copernico 324



Equinoxe 325



Kepler 326



Spark 327



Dna 328



Grape 329



Umile 330



Rustik 334



Blob 334



Pan 335



Kiss 335



Triumph 336



Lingotto 337



Igor 338



Clarissa 342



Onion 343



Ampolla 344



Volt 346



Abc 347



Citrus 348



Bergen 349



Klaus 351



Frida 352



Doc 353



Edelweiss 354



Lugano 355



Cantina 356



Brooklyn 357



Mint 361



Bistrò 362



Gretel 364



Hansel 365



Newton 366



Triade 367



Metro 368



Folk 371



Sailor 372



Moby 373



Fisherman 374



Fiordi 375



Nabucco 376



Beethoven 377



Continental 382



Redentore 383



Amadeus 384



Giudecca 385



Tiepolo 386



Rose 387



Florian 388



Liberty 395



Casanova 396



Doge 397



Danieli 398



Brigitta 399



Alexander 400



Baronet 401



Culto 331



World 332



Loko 333



Ice 339



Plumber 340



Electric 341



Saloon 350



Cesto 350



Tnt 351



Up and Down 358



Mandarin 359



Eris 360



Breeze 368



Hangar 369



Navy 370



Colossal 378



Santa 380



Negresco 381



Napoleon 390



Gioconda 392



Impero 394



Strauss 402



Ca' D'oro 403



Rialto 403



Mint

Pag 361

Classico

Lampade a sospensione



Radetzky 404



Renoir 405



Vanity 406



Maximilian 407



Miramare 407



Bon Bon 408



White Lady 409



Blanche 412



Accademy 413



Pegaso 414



Event 416



Terry 416



Pantheon 417



Violette 418



Spiga 421



Duca 421



Elisir 422



Martinez 423



Carlton 424



Elegant 425



Majestic 425



Evasione 429



Audi-77 429



Pearl 430



Dubai 431



Caesar 432



Augustus 433



Opera 434



Harem 438



Hamam 439



Nawa 440



Kronplatz 441



Amaca 442



Haunt 443



Canapa 444



Chalet 448



Driftwood 449



Volterra 450



Pisa 450



Giglio 451



Firenze 451



Palio 452



Tirol 454



Valentina 454



Foglia 455



Cascina 456



Justine 456



Corte 457



Sem 458



Norma 461



Stella 462



Deca 463



Orangerie 464



Rondo 465



Maglie 466



Anfora 466



Windsor 409



Camelia 410



Lilly 411



Senix 419



Romantik 419



Provence 420



Alba 426



Luxor 427



Pashà 428



Swan 436



Paris 437



Queen 437



Corda 445



Millennium 446



Monet 447



Cortina 452



Artù 453



Camilla 453



Brandy 459



Potty 460



Entry 460



Kyoto 467



Nabucco

Pag 376



Copernico

Montatura in metallo verniciato bianco o nero opaco con dettagli in ottone. Diffusori in vetro incamiciato bianco soffiato e acidato.

LED Lampadine LED G9 3,2W 3000 K incluse. Cod. 209043

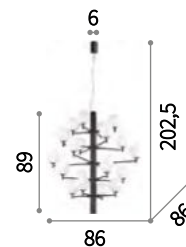

IP20
 10,270 Kg / 0,1340 m³
 G9 max 20 x 40W
 197326 € 835
 197333 € 835

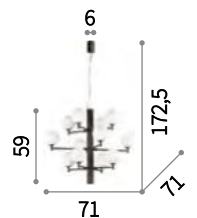

IP20
 6,870 Kg / 0,0903 m³
 G9 max 12 x 40W
 197302 € 525
 197319 € 525

3000 K / 300 Lm
 209043 € 3,50

3000 K / 300 Lm
 209043 € 3,50



200125



Equinoxe

Montatura a bracci in metallo con finitura cromo o ottone antico. Diffusori in vetro soffiato trasparente.

LED Lampadine LED G4 2W 3000 K incluse. Cod. 222257



200118

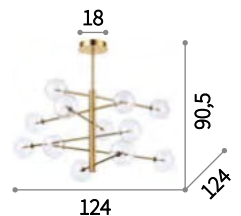

IP20

5,540 Kg / 0,1304 m³
G4 max 12x2W

200118 € 680
200125 € 732



P. 488

3000 K / 170 Lm
222257 € 3,90



Kepler

Catena e montatura in metallo verniciato nero opaco. Diffusori in vetro soffiato trasparente ambrato.

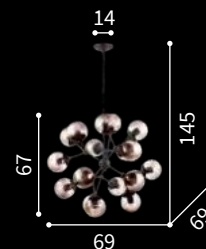

IP20

5,300 Kg / 0,1296 m³
E27 max 18 x 40W

162478 ■ € 650

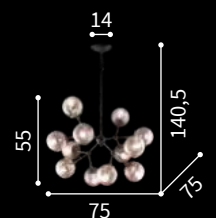

IP20

3,630 Kg / 0,1010 m³
E27 max 12 x 40W

162201 ■ € 440



P. 489

3000 K / 430 Lm
101279 € 2,90

3000 K / 430 Lm
101279 € 2,90



Spark **new**

Rosone e montatura in metallo verniciato nero opaco con portalampade placcati. Cavo elettrico rivestito in tessuto.

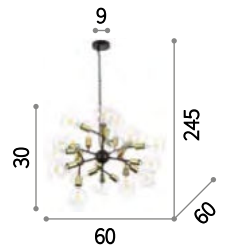

IP20

3,000 Kg / 0,0885 m³
E27 max 24 x 60W

238241 ■ € 380 **new**





Dna

Rosone e montatura in metallo dorato.
 Diffusori in vetro incamiciato bianco,
 soffiato e acidato. Cavi d'acciaio regolabili.

LED Lampadine LED G9 3,2W 3000 K
 incluse. Cod. 209043



IP20   

4,930 Kg / 0,1901 m³
 G9 max 25 x 15W

208398 € 835

 3000 K / 300 Lm
 209043 € 3,50



Grape **new**

Montatura in metallo rifinito ottone satinato. Cavi rivestiti in tessuto. Diffusore in vetro soffiato bianco con striature satinato.

LED

Lampadine LED G9 3,2W 3000 K incluse nel modello 241340. Cod. 209043

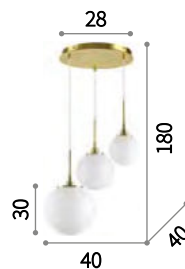

IP20

3,300 Kg / 0,0639 m³
G9 max 3 x 28W

241340 € 220 **new**



IP20

3,080 Kg / 0,1303 m³
E27 max 1 x 60W

241364 € 155 **new**

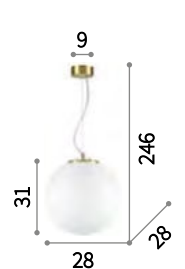

IP20

2,500 Kg / 0,0693 m³
E27 max 1 x 60W

241357 € 110 **new**

3000 K / 300 Lm
209043 € 3,50

3000 K / 720 Lm
123899 € 6,90

3000 K / 720 Lm
123899 € 6,90

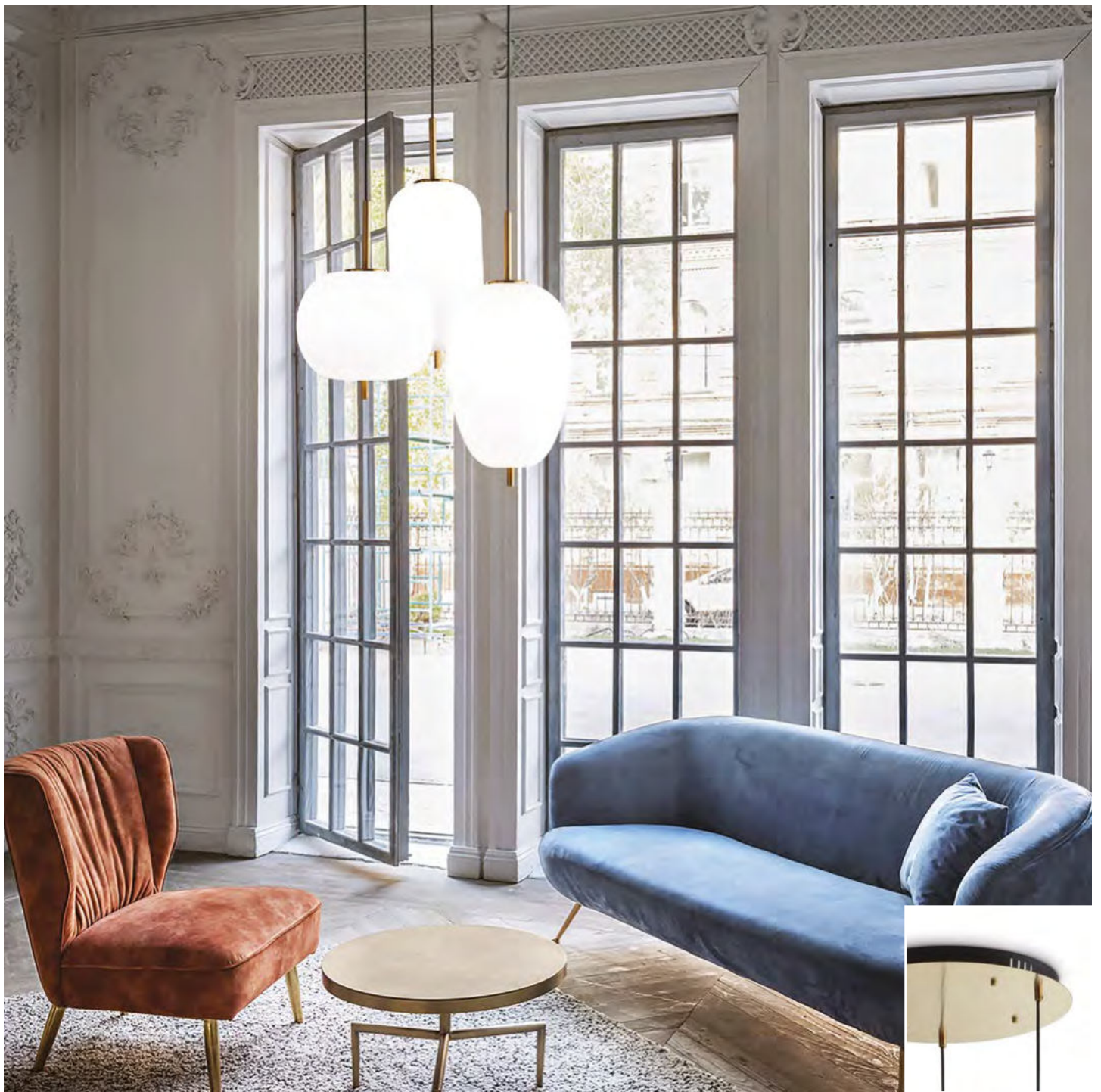

Umile **new**

Rosone ed elementi decorativi in metallo con finitura oro satinato. Diffusori in vetro soffiato bianco acidato. Led integrati.

LED Sorgente luminosa LED 3000 K, 20.000 h di durata.

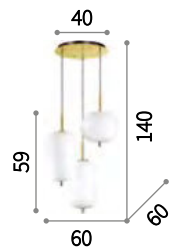

IP20

8,600 Kg / 0,2150 m³
LED 50W / 3160 Lm

224541 € 350 **new**



Culto **new**

Montatura in metallo verniciato nero opaco e base con elemento in ottone satinato. Diffusori in vetro soffiato bianco, acidato. Cavo rivestito in pvc nero.

LED Lampadine LED G9 3,2W 3000 K incluse. Cod. 209043



P. 470 P. 489 P. 522 P. 547

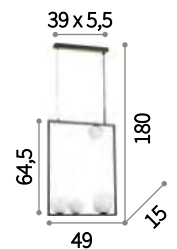

IP20 INCLUDE

2,420 Kg / 0,0808 m³
G9 max 4 x 28W

225135 ■ € 260 **new**

3000 K / 300 Lm
209043 € 3,50



World

Montatura in metallo con finitura brunito o cromo. Diffusore in vetro soffiato trasparente. SP4 con paralumi in PVC rivestiti in tessuto. Copricatena in velluto.

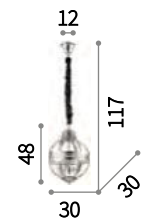
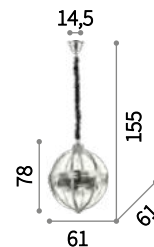

IP20

IP20

13,020 Kg / 0,5011 m³
E14 max 4 x 40W

4,870 Kg / 0,0771 m³
E14 max 3 x 40W

156347 € 965
156330 € 965

156323 € 450
156316 € 450

3000 K / 430 Lm
101224 € 2,90

3000 K / 430 Lm
101224 € 2,90



Loko

Montatura in metallo con finitura ottone satinato. Diffusore in vetro incamiciato bianco, soffiato e acidato.

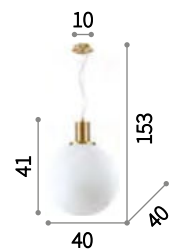

IP20

2,970 Kg / 0,1290 m³
E27 max 1 x 60W

197920 € 200

3000 K / 720 Lm
101354 € 9,00

Rustik

Rosone in metallo nero opaco. Cavo in tessuto. Portalampade in metallo brunito. Diffusore in vetro soffiato trasparente effetto fumè.

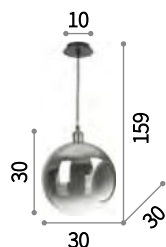

IP20

2,780 Kg / 0,0664 m³
E27 max 1 x 60W

198071 € 148

2200 K / 300 Lm
151717 € 6,90



Blob

Montatura in metallo. Cavo in tessuto. Diffusore in vetro soffiato trasparente con finitura fumè o ambra.

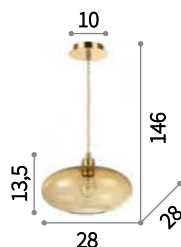

IP20

1,470 Kg / 0,0347 m³
E27 max 1 x 42W

207988 € 130
207995 € 130

3000 K / 860 Lm
119571 € 6,50



Pan

Montatura in metallo. Diffusori con elementi decorativi a tubi metallici di diverse misure. Cavi d'acciaio regolabili.

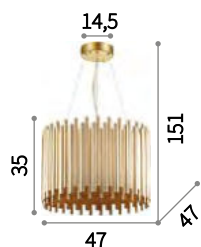

IP20

13,920 Kg / 0,1355 m³
E27 max 5 x 60W

208817 € 626

3000 K / 860 Lm
119571 € 6,50

P. 490



Kiss

Rosone, elemento centrale con portalampade e aste decorative interamente in metallo con finitura ottone satinato.

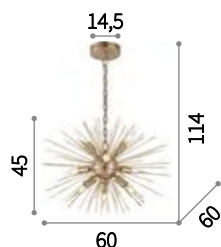

IP20

3,490 Kg / 0,1861 m³
E14 max 9 x 40W

201368 € 520

2200 K / 300 Lm
151649 € 4,50





160269

Triumph **new**

Montatura interamente in metallo con finitura nero o ottone invecchiato.



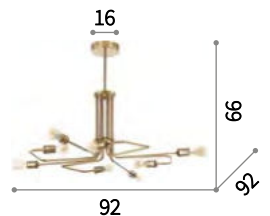

242347



IP20

3,640 Kg / 0,0470 m³
E27 max 8x60W

160269  € 445
242347  € 410 **new**



P. 470

P. 490

 2200 K / 300 Lm
151687 € 4,90



Lingotto

Montatura in metallo verniciato: base nera opaca e telaio ottone opaco. Diffusori in vetro incamiciato bianco, soffiato e acidato.

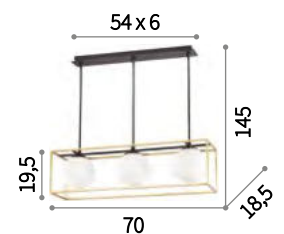

IP20

4,530 Kg / 0,0564 m³
E14 max 3 x 40W

198125 € 240



P. 471

3000 K / 360 Lm
101217 € 3,00



Igor

Montatura in metallo con finitura opaca nera. Diffusore con lastre di vetro trasparente.

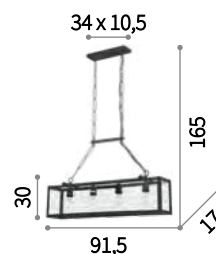

IP20

8,810 Kg / 0,0941 m³
E27 max 4x60W

092942 ■ € 300

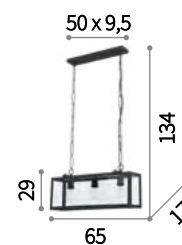

IP20

7,100 Kg / 0,0682 m³
E27 max 3x60W

092881 ■ € 220

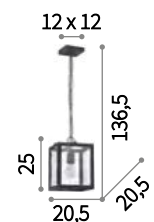

IP20

2,600 Kg / 0,0281 m³
E27 max 1x60W

092850 ■ € 110



P. 491

2200 K / 300 Lm
151694 € 5,90

2200 K / 300 Lm
151694 € 5,90

2200 K / 300 Lm
151694 € 5,90



237664

Ice **new**

Rosone e montatura in metallo verniciato bianco o nero opaco. Copri porta lampade in metallo rifinito ottone satinato. Cavo elettrico in pvc.



237671

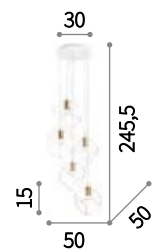

IP20

2,920 Kg / 0,0345 m³
E27 max 5 x 60W

237671 ■ € 160 **new**
237664 ■ € 160 **new**

 3000 K / 360 Lm
101286 € 3,00



Plumber

Montatura con elementi idraulici in metallo. Finiture: nero opaco o nero antichizzato. Modello SP1 con cavo in tessuto intrecciato.



136738



175355

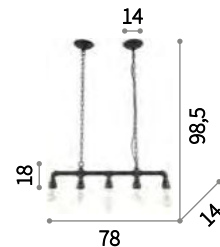

IP20

3,270 Kg / 0,0304 m³
E27 max 5 x 60W

175355 ■ € 170
136738 ■ € 170



IP20

0,890 Kg / 0,0032 m³
E27 max 1 x 60W

187716 ■ € 58
155906 ■ € 58

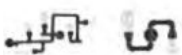

P. 472 P. 491

2200 K / 300 Lm
151687 € 4,90

2200 K / 300 Lm
151717 € 6,90



Electric

Montatura in metallo rifinito corten. Cavo in tessuto. Portalampane in ceramica smaltata. Cavi in acciaio a lunghezza regolabile.

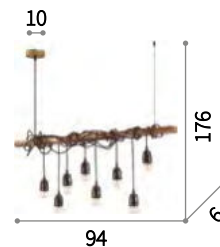

IP20

3,000 Kg / 0,0162 m³
E27 max 8 x 60W

176369 ■ € 230

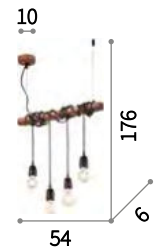

IP20

1,800 Kg / 0,0093 m³
E27 max 4 x 60W

176352 ■ € 150

 2200 K / 300 Lm
151687 € 4,90

 2200 K / 300 Lm
151687 € 4,90



220604



Clarissa

Rosone, copri portalampane e diffusore interamente in metallo verniciato bianco opaco o rifinito in rame lucido.



220611

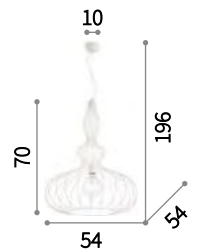

IP20

3,000 Kg / 0,3169 m³
E27 max 1x8W

220604 € 178
220611 € 278

3000 K / 860 Lm
101323 € 7,90



Onion

Montatura interamente in metallo rifinito con vernice marrone a effetto metallico. Cavo in tessuto.

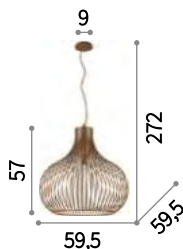

IP20

5,050 Kg / 0,2383 m³
E27 max 1 x 60W
205311 € 325



IP20

3,520 Kg / 0,1325 m³
E27 max 1 x 60W
205304 € 220



IP20

2,380 Kg / 0,0705 m³
E27 max 1 x 60W
205298 € 135

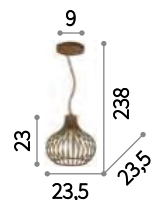

IP20

1,260 Kg / 0,0169 m³
E27 max 1 x 60W
205281 € 65

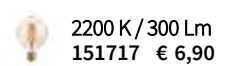
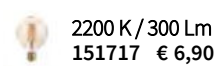
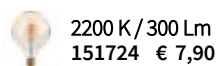
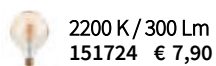



Ampolla

Rosone porta lampade e struttura decorativa in metallo con finitura bianco, nero e rame. Cavo elettrico regolabile in lunghezza.

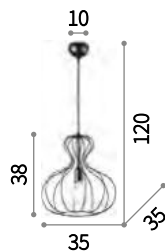

IP20

0,950 Kg / 0,0709 m³
E27 max 1 x 60W

194295 € 90
166209 € 95
148502 € 90

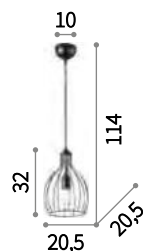

IP20

0,590 Kg / 0,0480 m³
E27 max 1 x 60W

200880 € 80
167282 € 85
148151 € 80

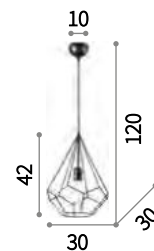

IP20

0,720 Kg / 0,0480 m³
E27 max 1 x 60W

200897 € 140
167367 € 150
148175 € 140

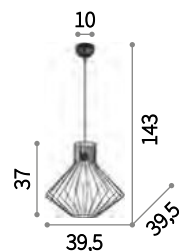

IP20

1,470 Kg / 0,1013 m³
E27 max 1 x 60W

200903 € 160
167503 € 169
167497 € 160

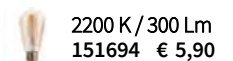
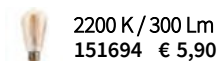
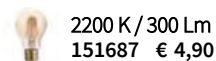
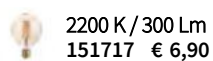



148502



Volt

Montatura interamente in metallo con finitura rame. Sospensione con cavo elettrico regolabile in lunghezza.

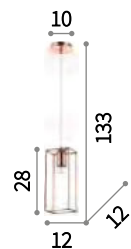

IP20

0,810 Kg / 0,0067 m³
E27 max 1 x 60W

137124 € 64

2200 K / 300 Lm
151687 € 4,90



Abc

Rosone, copri portalamapade e struttura decorativa interamente in metallo rifinito ottone satinato. Cavo in tessuto nero.

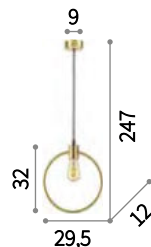

IP20

0,570 Kg / 0,0077 m³
E27 max 1x 70W

207841 € 88

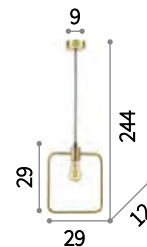

IP20

0,610 Kg / 0,0077 m³
E27 max 1x 70W

207858 € 88

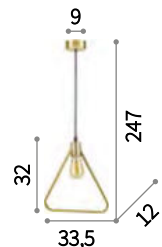

IP20

0,590 Kg / 0,0088 m³
E27 max 1x 70W

207834 € 88

2200 K / 300 Lm
151700 € 4,50

2200 K / 300 Lm
151717 € 6,90

2200 K / 300 Lm
151694 € 5,90



Citrus

Rosone in legno naturale. Corpo luce con elementi in multistrato di legno verniciato. Cavo in tessuto nero.

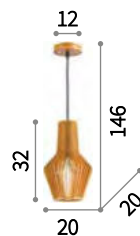

IP20

0,660 Kg / 0,0174 m³
E27 max 1x60W

159843 € 115

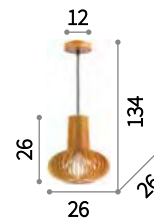

IP20

0,720 Kg / 0,0242 m³
E27 max 1x60W

159850 € 125

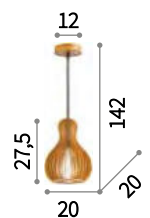

IP20

0,510 Kg / 0,0148 m³
E27 max 1x60W

159867 € 95

3000 K / 860 Lm
119571 € 6,50

3000 K / 860 Lm
119571 € 6,50

3000 K / 860 Lm
119571 € 6,50



Bergen **new**

Rosone in metallo verniciato a polveri di colore nero. Montatura in legno naturale. Diffusore in vetro soffiato trasparente con motivo decorativo in rilievo e finitura fumè. Cavo rivestito in tessuto.

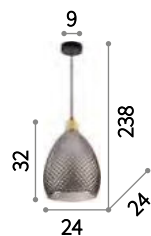

1,430 Kg / 0,0315 m³
E27 max 1 x 60W

238746 € 145 **new**

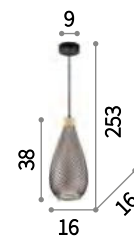

1,570 Kg / 0,0236 m³
E27 max 1 x 60W

238838 € 145 **new**



1,840 Kg / 0,0347 m³
E27 max 1 x 60W

238920 € 145 **new**

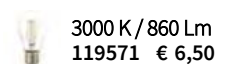
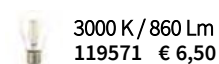
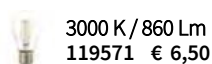

Saloon

Rosone in metallo con finitura bronzo.
Cavi elettrici in tessuto. Paralume in metallo rifinito nickel, lavorato e antichizzato a mano.

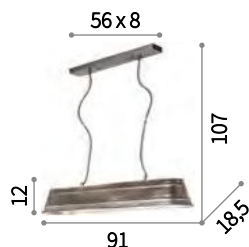

IP20

2,310 Kg / 0,0374 m³
E27 max 4 x 60W

195872 € 260

3000 K / 860 Lm
119571 € 6,50



Cesto

Montatura e diffusore interamente in metallo modellato artigianalmente con finitura grezza. Cavo in tessuto.



IP20

1,610 Kg / 0,0800 m³
E27 max 1 x 60W

162416 € 150

2200 K / 300 Lm
151724 € 7,90



Tnt

Montatura con elementi idraulici in metallo rifinito con effetto ghisa. Corpo luce in cemento. Diffusore con gabbia metallica.

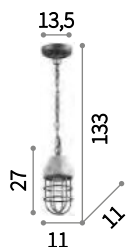

1,600 Kg / 0,0160 m³
E27 max 1 x 60W

168159 ■ € 88

 2200 K / 300 Lm
151687 ■ € 4,90



Klaus

Rosone e copri portalampada in ceramica smaltata lucida. Cavo elettrico intrecciato rivestito in tessuto.

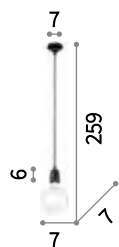

0,280 Kg / 0,0006 m³
E27 max 1 x 60W

135038 ■ € 29

 2200 K / 300 Lm
151694 ■ € 5,90





Frida

Rosone e copriportalampada in metallo con finiture varie. Cavo in tessuto nero.

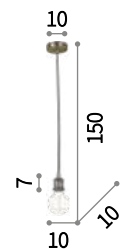

IP20

0,320 Kg / 0,0015 m³
E27 max 1 x 60W

139432	■	€ 29
122106	■	€ 29
122083	■	€ 29
139425	■	€ 29



P. 492 P. 651

2200 K / 300 Lm
151717 € 6,90



Doc

Rosone e copriportalampada in metallo con finiture varie. Cavo in tessuto nero. Interruttore incorporato al portalampade.

ON
OFF Lampada con interruttore integrato.

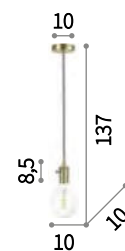

IP20

0,220 Kg / 0,0015 m³
E27 max 1 x 60W

- 163123 € 52
- 163154 € 52
- 163109 € 52
- 163161 € 52

2200 K / 300 Lm
223933 € 7,50



Edelweiss

Rosone in metallo verniciato opaco. Cavo in tessuto con portalampade in metallo brunito. Diffusore in ceramica.



⏏ (⊕) IP20

4,960 Kg / 0,0600 m³
E27 max 4 x 60W
206790 ■ € 420

💡 3000 K / 720 Lm
123899 € 6,90



Lugano

Rosone in metallo verniciato opaco. Cavo in tessuto con portalampane in metallo brunito. Diffusore in ceramica.

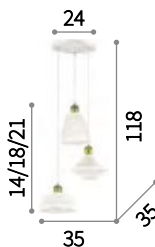

IP20

2,950 Kg / 0,0618 m³
E27 max 3 x 60W

206875 € 330

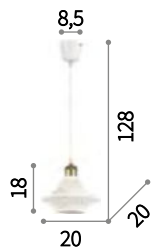

IP20

0,850 Kg / 0,0090 m³
E27 max 1 x 60W

206806 € 104

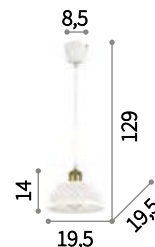

IP20

0,700 Kg / 0,0063 m³
E27 max 1 x 60W

206844 € 104

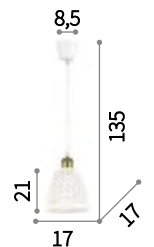

IP20

0,860 Kg / 0,0068 m³
E27 max 1 x 60W

206820 € 104

3000 K / 720 Lm
123899 € 6,90

3000 K / 720 Lm
123899 € 6,90

3000 K / 720 Lm
123899 € 6,90

3000 K / 720 Lm
123899 € 6,90



Cantina

Montatura, diffusore e copriportalampada in metallo disponibile con finitura brunito o rame. Cavo elettrico rivestito in tessuto e intrecciato.

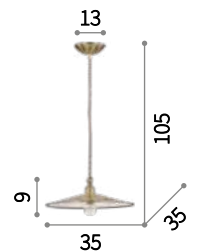

IP20

0,810 Kg / 0,0189 m³
E27 max 1x60W

112732 € 70
112701 € 70

3000 K / 860 Lm
119571 € 6,50





Brooklyn

Montatura in metallo con finitura in brunito. Diffusore in cemento. Sospensioni con cavo in tessuto nero.

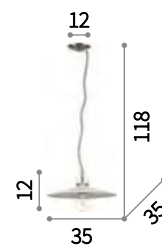

IP20

1,930 Kg / 0,0552 m³
E27 max 1 x 60W

153445 ■ € 118



IP20

1,070 Kg / 0,0244 m³
E27 max 1 x 60W

153438 ■ € 95

2200 K / 300 Lm
151694 € 5,90

2200 K / 300 Lm
151694 € 5,90



Up and Down

Montatura in metallo rifinito con vernice nera opaca. Copri portalampade e viti in metallo brunito. Diffusori regolabili in altezza individualmente con sistema a contrappeso.

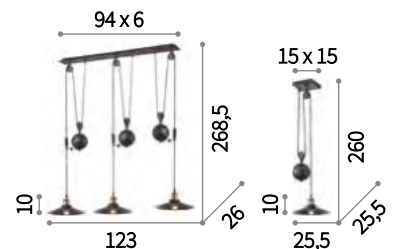

IP20

6,760 Kg / 0,0582 m³
E27 max 3 x 60W

136349 ■ € 335

IP20

1,940 Kg / 0,0151 m³
E27 max 1 x 60W

136332 ■ € 118

2200 K / 300 Lm
151687 € 4,90

2200 K / 300 Lm
151687 € 4,90



Mandarin

Montatura e diffusore in metallo. Interno rifinito con smalto bianco. Cavo elettrico regolabile in lunghezza.

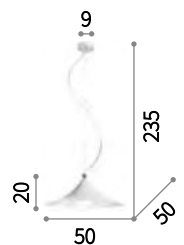

IP20

1,870 Kg / 0,0622 m³
E27 max 1 x 60W

087276 € 108

3000 K / 720 Lm
101354 € 9,00



Eris **new**

Montatura in metallo con rosone e diffusore verniciati bianco o nero opaco, dettagli in finitura oro satinato. Cavo elettrico intrecciato con rivestimento in tessuto.

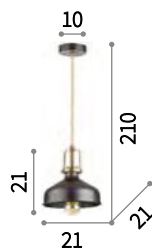

IP20

0,630 Kg / 0,0102 m³
E27 max 1 x 60W

238104 € 50 **new**
249056 € 50 **new**



IP20

1,080 Kg / 0,0257 m³
E27 max 1 x 60W

238135 € 60 **new**
249063 € 60 **new**



IP20

0,740 Kg / 0,0126 m³
E27 max 1 x 60W

238173 € 50 **new**
249070 € 50 **new**

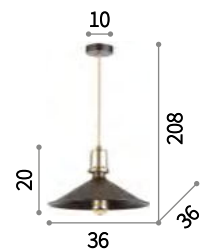

IP20

0,960 Kg / 0,0231 m³
E27 max 1 x 60W

238210 € 60 **new**
249087 € 60 **new**

3000 K / 360 Lm
101286 € 3,00

3000 K / 720 Lm
101330 € 8,50

3000 K / 360 Lm
101286 € 3,00

3000 K / 360 Lm
101286 € 3,00



Mint **new**

Montatura in metallo con finitura ottone satinato e rosone nero opaco. Cavo rivestito in tessuto. Diffusore in vetro soffiato con rigatura in rilievo. Disponibile nelle finiture fumè o verde.



237398

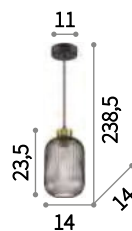

1,350 Kg / 0,0147 m³
E27 max 1x60W

237442 € 75 **new**
248554 € 75 **new**



1,560 Kg / 0,0532 m³
E27 max 1x60W

237398 € 100 **new**
237428 € 100 **new**



1,80 Kg / 0,0269 m³
E27 max 1x60W

237510 € 110 **new**
237497 € 110 **new**

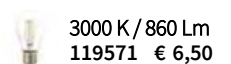
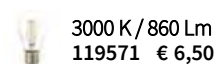
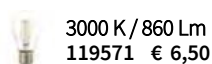



Bistrò

Montatura in metallo verniciato nero.
 Diffusore in vetro, ambra, trasparente o
 fumè, soffiato e modellato artigianalmente.

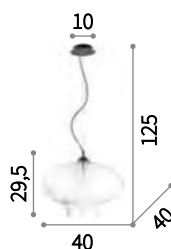

IP20

2,190 Kg / 0,0806 m³
 E27 max 1x60W

120898 € 158
 163772 € 158
 120904 € 180

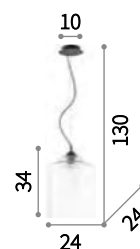

IP20

1,840 Kg / 0,0427 m³
 E27 max 1x60W

112305 € 105
 163789 € 105
 112312 € 120

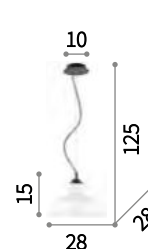

IP20

1,200 Kg / 0,0274 m³
 E27 max 1x60W

112336 € 80
 112343 € 87

3000 K / 860 Lm
 119571 € 6,50

3000 K / 860 Lm
 119571 € 6,50

3000 K / 860 Lm
 119571 € 6,50





Gretel

Montatura in metallo rifinito in vernice nera opaca con applicazione in legno naturale. Diffusori in vetro soffiato trasparente. Cavi in tessuto nero.

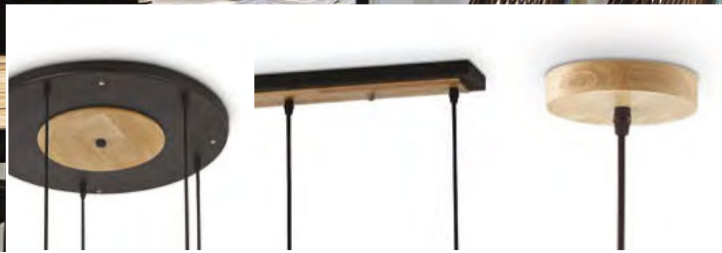

IP20

5,960 Kg / 0,0206 m³
E27 max 5 x 60W

103174 ■ € 390

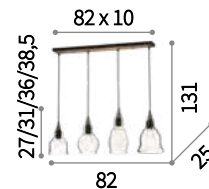

IP20

4,090 Kg / 0,0205 m³
E27 max 4 x 60W

122557 ■ € 320

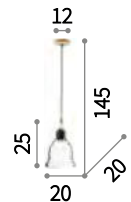

IP20

0,950 Kg / 0,0198 m³
E27 max 1 x 60W

122564 ■ € 80

3000 K / 860 Lm
119571 € 6,50

3000 K / 860 Lm
119571 € 6,50

3000 K / 860 Lm
119571 € 6,50



Hansel

Montatura in metallo verniciato nero opaco con inserto in corda. Diffusore in vetro trasparente ambrato con bordi nero opaco.

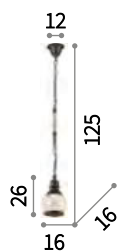

IP20

1,150 Kg / 0,1419 m³
E27 max 1x60W

168579 ■ € 95

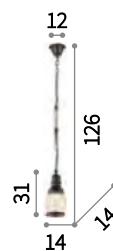

IP20

0,930 Kg / 0,0983 m³
E27 max 1x60W

168609 ■ € 95

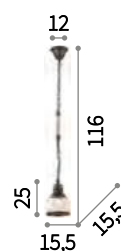

IP20

1,050 Kg / 0,0243 m³
E27 max 1x60W

168586 ■ € 95



3000 K / 860 Lm
119571 € 6,50



3000 K / 860 Lm
119571 € 6,50



3000 K / 860 Lm
119571 € 6,50



Newton

Montatura e diffusore in metallo. Braccio regolabile. Diffusore orientabile smaltato bianco all'interno nero all'esterno. Cavi in acciaio regolabili.

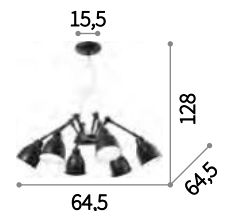

⏏ (E) IP20

3,530 Kg / 0,1393 m³
E27 max 6 x 60W

174242 ■ € 365



P. 493

P. 523

P. 550

💡 3000 K / 720 Lm
123899 € 6,90



Triade

Rosone e diffusore in metallo verniciato a polveri con interno bianco. Elemento decorativo a sfera dorato.

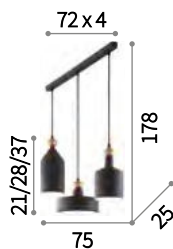

IP20

2,630 Kg / 0,0797 m³
E27 max 3 x 42W

194677 ■ € 195

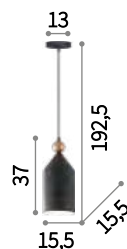

IP20

1,020 Kg / 0,0105 m³
E27 max 1 x 42W

194684 ■ € 55



IP20

0,960 Kg / 0,0169 m³
E27 max 1 x 42W

221489 ■ € 55

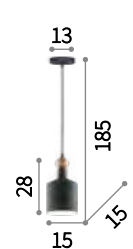

IP20

0,750 Kg / 0,0090 m³
E27 max 1 x 42W

221496 ■ € 55

3000 K / 720 Lm
101330 € 8,50

3000 K / 720 Lm
101330 € 8,50

3000 K / 720 Lm
101330 € 8,50

3000 K / 720 Lm
101330 € 8,50

Metro

Montatura e diffusore in metallo. Interno smaltato in bianco. Cavo elettrico regolabile in lunghezza.

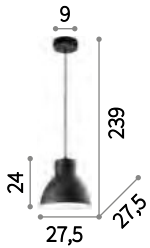

IP20

0,970 Kg / 0,0261 m³
E27 max 1 x 60W

139098 ■ € 56

3000 K / 720 Lm
101354 € 9,00



P. 652



Breeze new

Montatura e diffusore in metallo. Interno smaltato in bianco. Cavo elettrico regolabile in lunghezza.

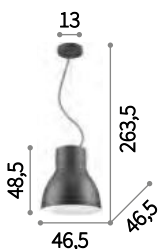

IP20

3,490 Kg / 0,070 m³
E27 max 1 x 60W

232041 ■ € 150 new

3000 K / 720 Lm
101354 € 9,00

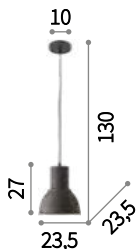

IP20

0,790 Kg / 0,0206 m³
E27 max 1 x 60W

137681 ■ € 50

3000 K / 720 Lm
101354 € 9,00





Hangar

Montatura e diffusore in alluminio anodizzato. Interno smaltato bianco. Cavo elettrico regolabile in lunghezza.



IP20

1,800 Kg / 0,0442 m³
E27 max 1x60W

100326 € 162
100333 € 162

3000 K / 720 Lm
101354 € 9,00



Navy

Montatura e diffusore in metallo con finitura alluminio, brunito e rame. Interno smaltato bianco. Cavo elettrico regolabile in lunghezza.

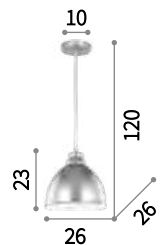

IP20

0,800 Kg / 0,0235 m³
E27 max 1 x 60W

020716	€ 76
020747	€ 76
020723	€ 76

3000 K / 720 Lm
101354 € 9,00



Folk

Rosone e diffusore in metallo decorato con effetto ossidato. Parabola interna ondulata e smaltata bianca. Cavo in tessuto nero.

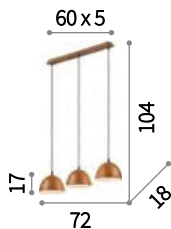

IP20

2,190 Kg / 0,0255 m³
E27 max 3 x 60W

174235 ■ € 170

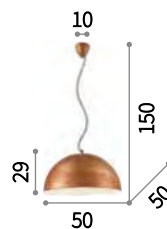

IP20

3,070 Kg / 0,0843 m³
E27 max 1 x 60W

174228 ■ € 230

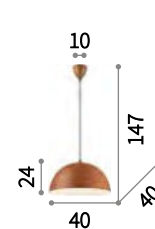

IP20

1,980 Kg / 0,0420 m³
E27 max 1 x 60W

174211 ■ € 128

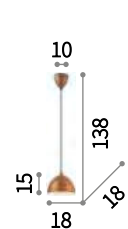

IP20

0,530 Kg / 0,0072 m³
E27 max 1 x 60W

174204 ■ € 50

3000 K / 360 Lm
101286 € 3,00

3000 K / 720 Lm
101354 € 9,00

3000 K / 720 Lm
101330 € 8,50

3000 K / 720 Lm
123899 € 6,90



025278

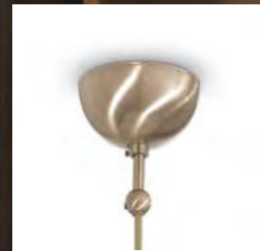

Sailor

Corpo luce a cupola in metallo con finitura brunito e rame e smaltato bianco all'interno. Diffusore in vetro soffiato con effetto rustico.



025308

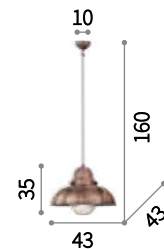

IP20

2,920 Kg / 0,1060 m³
E27 max 1 x 60W

025315 € 225
025285 € 225

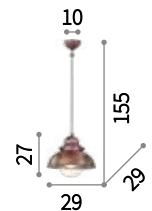

IP20

1,700 Kg / 0,0467 m³
E27 max 1 x 60W

025278 € 135
025308 € 135



P. 493

3000 K / 860 Lm
119571 € 6,50

3000 K / 860 Lm
119571 € 6,50



Moby

Montatura e diffusore in metallo con interno bianco. Disponibile nelle finiture alluminio, bianco, nero o rame.

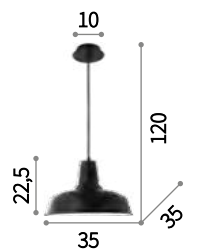

⚡ IP20

1,200 Kg / 0,0356 m³
E27 max 1x60W

102047	€ 94
102054	€ 125
093697	€ 125
093659	€ 94

💡 3000 K / 720 Lm
101330 € 8,50



P. 653



125824



Fisherman

Corpo luce interamente in metallo con finitura in cromo, rame o in vernice nera opaca. Diffusore in lastra di vetro serigrafato bianco.



134871

125831

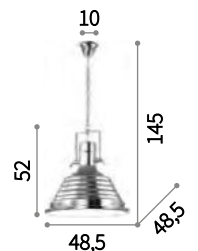

IP20

5,040 Kg / 0,0899 m³
E27 max 1x60W

125824 € 300
134871 € 300
125831 € 250

3000 K / 860 Lm
101323 € 7,90

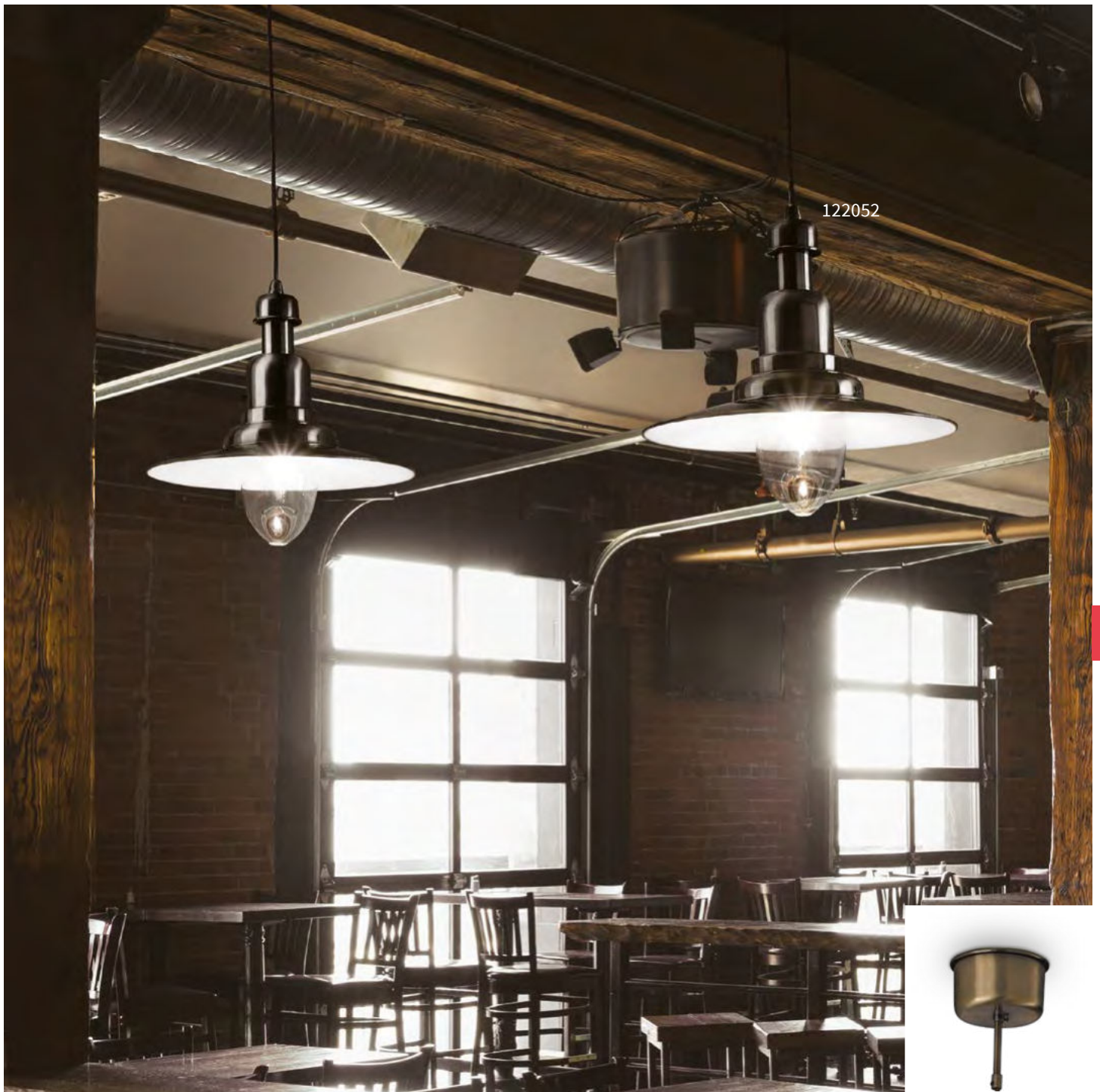

122052



Fiordi

Corpo luce in metallo, disponibile con finitura in brunito o smalto nero. Diffusore in vetro trasparente soffiato e rifinito artigianalmente.



005041

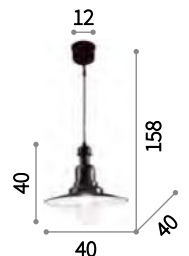

IP20

2,370 Kg / 0,0484 m³
E27 max 1x60W

005041 € 200
122052 € 200

3000 K / 860 Lm
119571 € 6,50



Nabucco **new**

Montatura in metallo con finitura oro. Elementi decorativi in cristallo trasparente molato. Quadrati nella parte superiore e a losanga in quella inferiore.

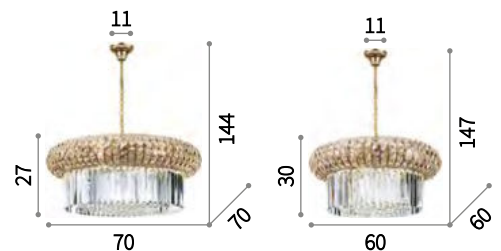

IP20

18,730 Kg / 0,2127 m³
E14 max 18 x 40W

237800 € 680 **new**

IP20

13,810 Kg / 0,1703 m³
E14 max 12 x 40W

237794 € 550 **new**

3000 K / 430 Lm
101200 € 2,90

3000 K / 430 Lm
101200 € 2,90



Beethoven

Lampadario in vetro trasparente soffiato e lavorato a mano. Montatura e dettagli in metallo rifinito in cromo. Copricatena in velluto.

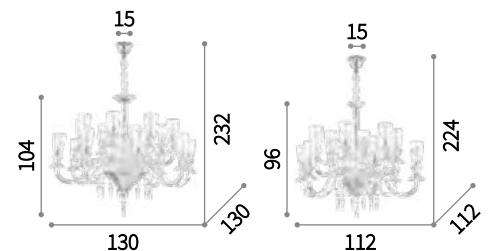

■ ⊕ IP20

34,000 Kg / 0,4950 m³
E14 max 16 x 40W

103426 € 1.500

■ ⊕ IP20

30,000 Kg / 0,3612 m³
E14 max 12 x 40W

103419 € 1.200

💡 3000 K / 430 Lm
101224 € 2,90

💡 3000 K / 430 Lm
101224 € 2,90



081564



114170

Colossal

Montatura e dettagli in metallo cromato.
 Bracci in vetro soffiato trasparente o
 con interno di colore grigio o bianco
 avorio. Pendagli ed elementi decorativi
 in vetro trasparente e cristallo molato.
 Copricatena in velluto.

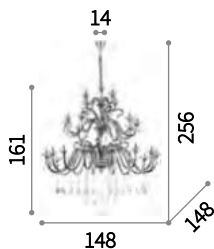

IP20

44,170 Kg / 0,7792 m³
 E14 max 30 x 40W

183077 € 2.600

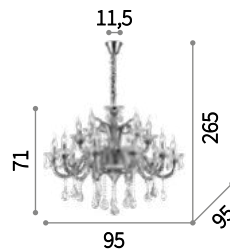

IP20

19,000 Kg / 0,2963 m³
 E14 max 15 x 40W

114170 € 970
 081564 € 1.000
 081526 € 1.000

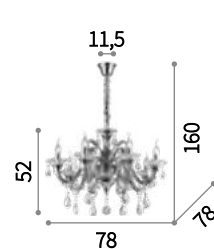

IP20

11,400 Kg / 0,1406 m³
 E14 max 8 x 40W

114187 € 590
 081557 € 625
 081519 € 625

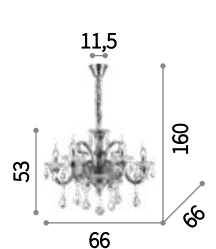

IP20

9,200 Kg / 0,1095 m³
 E14 max 6 x 40W

114194 € 480
 081540 € 500
 081502 € 500



P. 502

3000 K / 430 Lm
 101224 € 2,90

3000 K / 430 Lm
 101224 € 2,90

3000 K / 430 Lm
 101224 € 2,90

3000 K / 430 Lm
 101224 € 2,90

183077





Santa

Lampadario in vetro trasparente soffiato e lavorato a mano. Dettagli in metallo cromato. Copricatena in velluto.

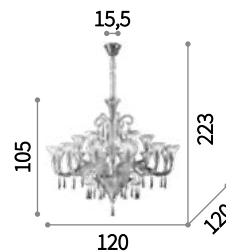

IP20

29,940 Kg / 0,3944 m³
E14 max 18 x 40W

142227 € 1.400

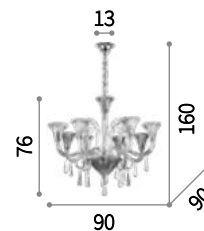

IP20

13,800 Kg / 0,1859 m³
E14 max 8 x 40W

103518 € 660

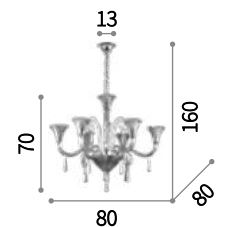

IP20

10,200 Kg / 0,1331 m³
E14 max 6 x 40W

103501 € 510



P. 502

3000 K / 430 Lm
101224 € 2,90

3000 K / 430 Lm
101224 € 2,90

3000 K / 430 Lm
101224 € 2,90



087771



Negresco

Montatura in metallo con finitura in cromo o dorata. Bracci in vetro soffiato trasparente con interno dorato nella versione oro. Centrale composto da blocchi di cristallo molato. Elementi decorativi in vetro trasparente e cristallo molato. Copricatena in velluto.



141060

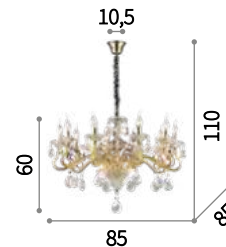

IP20

14,400 Kg / 0,1687 m³
E14 max 10 x 40W

141060 € 798
087771 € 848

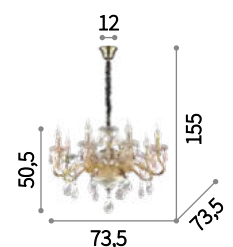

IP20

11,300 Kg / 0,1461 m³
E14 max 8 x 40W

141053 € 648
087764 € 686

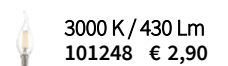
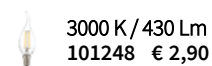



Continental

Montatura e dettagli in metallo cromato. Bracci in vetro soffiato. Pendagli ed elementi decorativi in vetro trasparente e cristallo molato. Copricatena in velluto.

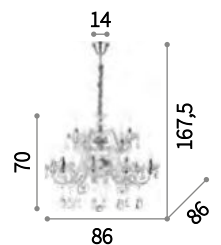

IP20

14,900 Kg / 0,2574 m³
E14 max 12 x 40W
207483 € 835

3000 K / 430 Lm
101224 € 2,90



Redentore

Montatura in metallo cromato. Elementi decorativi in vetro soffiato e cristallo molato. Copricatena in velluto.

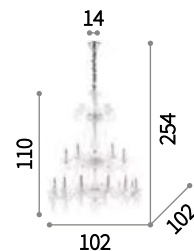

⌚ IP20

35,250 Kg / 0,3574 m³
E14 max 18 x 40W

176291 € 868

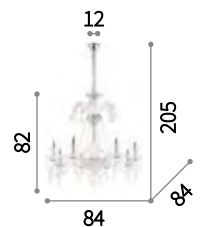

⌚ IP20

16,300 Kg / 0,2779 m³
E14 max 8 x 40W

187457 € 645

 3000 K / 430 Lm
101224 € 2,90

 3000 K / 430 Lm
101224 € 2,90



Amadeus

Montatura in metallo cromato. Elementi decorativi in vetro soffiato e cristallo molato. Copricatena in velluto.

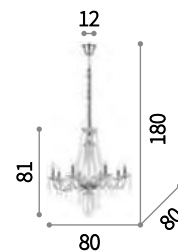

IP20

8,200 Kg / 0,1574 m³
E14 max 8 x 40W

168777 € 428

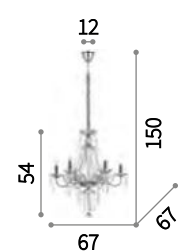

IP20

6,700 Kg / 0,1114 m³
E14 max 6 x 40W

168753 € 362

3000 K / 430 Lm
101224 € 2,90

3000 K / 430 Lm
101224 € 2,90



027838



Giudecca

Lampadario in vetro soffiato lavorato a mano con dettagli in metallo cromato. Pendagli con ottagoni e gocce in cristallo molato. Copricatena in velluto. Disponibile nelle finiture trasparente, nero e rosso.



032504



027418

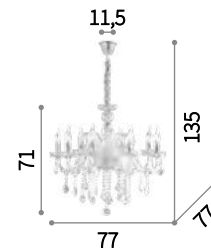

IP20

7,040 Kg / 0,1273 m³
E14 max 8 x 40W

027838 € 400

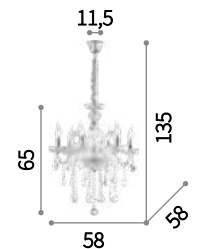

IP20

5,770 Kg / 0,1041 m³
E14 max 6 x 40W

027821 € 325
027418 € 345
032504 € 345

3000 K / 430 Lm
101248 € 2,90

3000 K / 430 Lm
101248 € 2,90



Tiepolo

Lampadario in vetro soffiato lavorato a mano con dettagli in metallo cromato. Pendagli con ottagononi e gocce in cristallo molato. Copricatena in velluto.

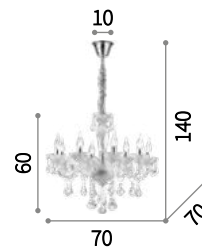

IP20

7,220 Kg / 0,1040 m³
E14 max 8x 40W

034720 € 440

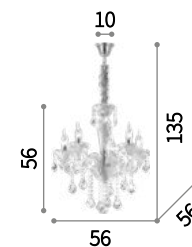

IP20

5,120 Kg / 0,0791 m³
E14 max 5x 40W

034713 € 370

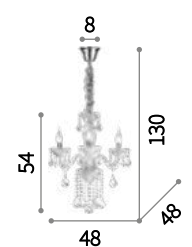

IP20

3,650 Kg / 0,0609 m³
E14 max 3x 40W

034706 € 263

3000 K / 360 Lm
101231 € 3,00

3000 K / 360 Lm
101231 € 3,00

3000 K / 360 Lm
101231 € 3,00



Rose

Lampadario in vetro soffiato con dettagli in metallo cromato. Ottagoni e gocce in cristallo molato. Copricatena in velluto.

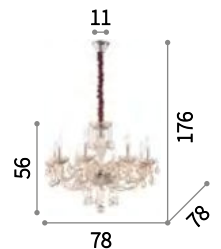

⏏ Ⓢ IP20

7,630 Kg / 0,1321 m³
E14 max 8x40W
166889 € 470

 3000 K / 430 Lm
101248 € 2,90



Florian

Montatura in metallo con elementi decorativi in vetro. Pendagli con ottagoni e gocce finali in cristallo molato. Disponibile nelle versioni con vetro trasparente e metallo dorato o cromato.

IP20	IP20	IP20
17,200 Kg / 0,3482 m ³ E14 max 18 x 40W	9,760 Kg / 0,2187 m ³ E14 max 12 x 40W	6,380 Kg / 0,1368 m ³ E14 max 6 x 40W
075150 € 878 075181 € 920	035604 € 554 035611 € 574	035628 € 428 035635 € 444



P. 503

P. 554

3000 K / 430 Lm
101224 € 2,90

3000 K / 430 Lm
101224 € 2,90

3000 K / 430 Lm
101224 € 2,90

035604





167398

Napoleon

Montatura in metallo cromato o dorato.
Elementi decorativi in vetro soffiato e
cristallo molato. Copricatena in velluto.

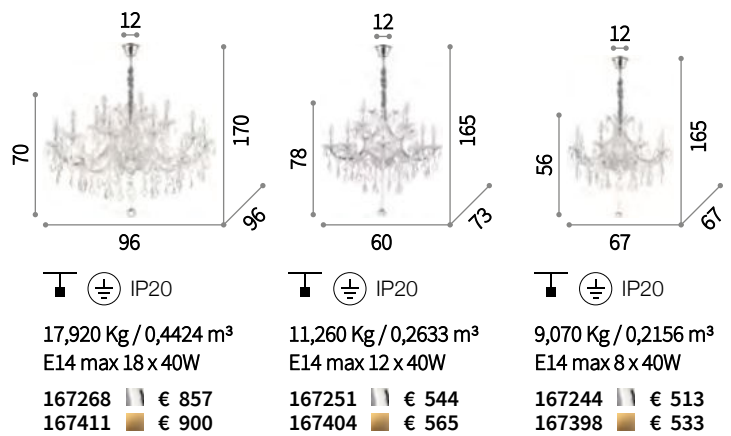

3000 K / 430 Lm
101224 € 2,90

3000 K / 430 Lm
101224 € 2,90

3000 K / 430 Lm
101224 € 2,90



167268





Gioconda

Corpo luce in fusione di metallo con finitura oro o argento antico. Pendagli ottagonali e tondi in cristallo molato. Copricatena in velluto.

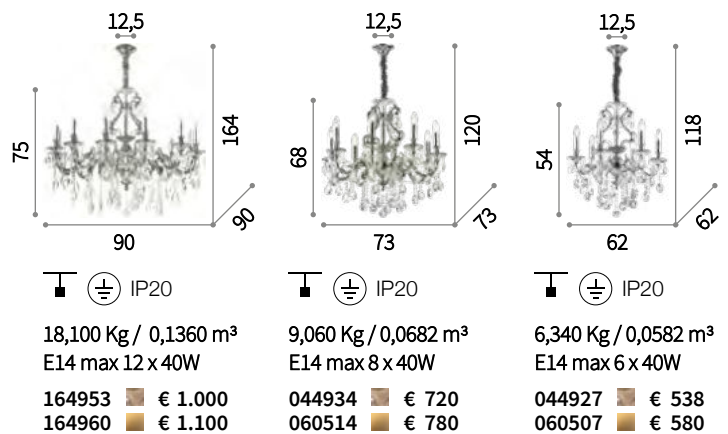

P. 504



3000 K / 430 Lm
101224 € 2,90



3000 K / 430 Lm
101224 € 2,90



3000 K / 430 Lm
101224 € 2,90



044934



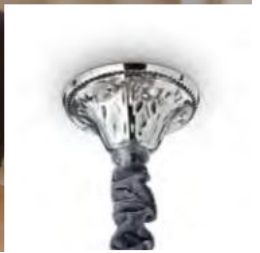

Impero

Corpo luce in fusione di metallo con finitura argento antico. Elementi decorativi in cristallo molato. Copricatena in velluto.

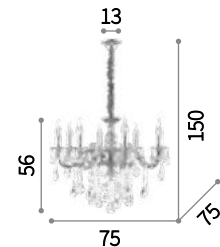

IP20

7,500 Kg / 0,0454 m³
E14 max 8 x 40W

014395 € 630

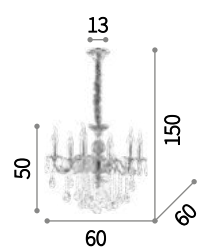

IP20

5,000 Kg / 0,0340 m³
E14 max 6 x 40W

002408 € 430

3000 K / 430 Lm
101224 € 2,90

3000 K / 430 Lm
101224 € 2,90



Liberty

Montatura in metallo verniciato color ruggine. Elementi decorativi in cristallo molato. Copricatena in velluto.

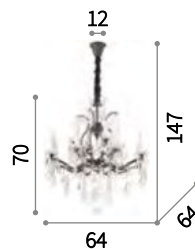

IP20

8,660 Kg / 0,2042 m³
E14 max 12 x 40W

166551 ■ € 566

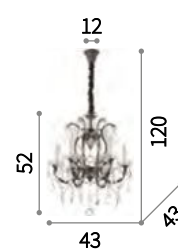

IP20

5,300 Kg / 0,1160 m³
E14 max 6 x 40W

073729 ■ € 366

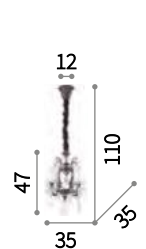

IP20

3,800 Kg / 0,0643 m³
E14 max 4 x 40W

166544 ■ € 266

3000 K / 430 Lm
101224 € 2,90

3000 K / 430 Lm
101224 € 2,90

3000 K / 430 Lm
101224 € 2,90



104775

Casanova

Lampadario in vetro soffiato e lavorato a mano con copri portalampade e dettagli in metallo cromato. Disponibile trasparente, bianco, multicolor o fumè.

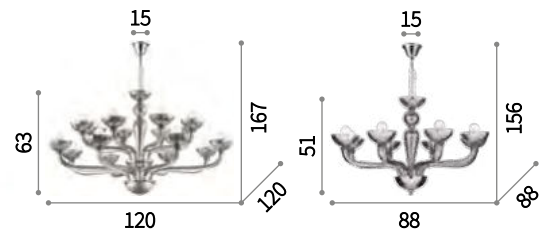

IP20

15,960 Kg / 0,2445 m³
E14 max 16 x 40W

044248 € 1.150
094120 € 1.250
095639 € 1.350

IP20

9,210 Kg / 0,1592 m³
E14 max 8 x 40W

044255 € 570
094045 € 600
095615 € 630
104775 € 600

3000 K / 430 Lm
101200 € 2,90

3000 K / 430 Lm
101200 € 2,90



044453



Doge

Lampadario in vetro, trasparente o bianco, soffiato e lavorato a mano. Montatura e dettagli in metallo rifinito in cromo.



113678

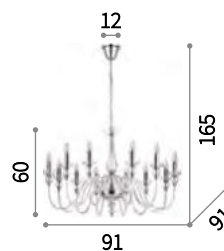

IP20

9,400 Kg / 0,3064 m³
E14 max 12 x 40W

168906 € 560

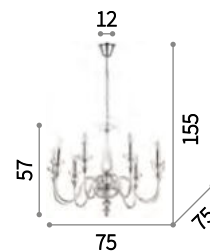

IP20

6,660 Kg / 0,2071 m³
E14 max 9 x 40W

044453 € 460

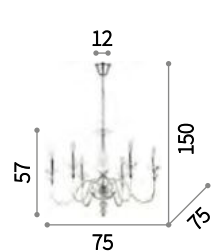

IP20

5,240 Kg / 0,1537 m³
E14 max 6 x 40W

044422 € 360
113678 € 420



P. 504



3000 K / 430 Lm
101224 € 2,90



3000 K / 430 Lm
101224 € 2,90



3000 K / 430 Lm
101224 € 2,90



159973

Danieli

Montatura in metallo cromato o dorato. Elementi decorativi in vetro soffiato trasparente o ambrato. Copricatena in velluto.



213484

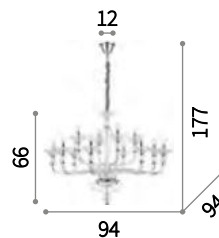

IP20

10,180 Kg / 0,2477 m³
E14 max 12 x 40W

213484 € 680
221373 € 770

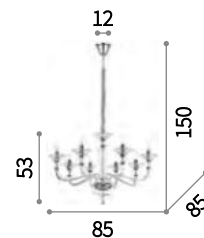

IP20

7,510 Kg / 0,2048 m³
E14 max 8 x 40W

159980 € 500
159973 € 530

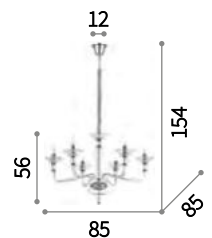

IP20

3,840 Kg / 0,1759 m³
E14 max 6 x 40W

159959 € 440
159942 € 480

3000 K / 430 Lm
101200 € 2,90

3000 K / 430 Lm
101200 € 2,90

3000 K / 430 Lm
101200 € 2,90



199375

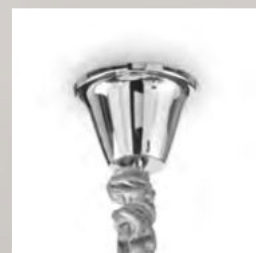

Brigitta

Lampadario in vetro soffiato trasparente o ambrato, lavorato artigianalmente con montatura in metallo e copricatena in velluto.



199412

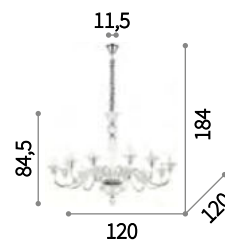

IP20

12,500 Kg / 0,2380 m³
E14 max 12 x 40W

199375 € 730
199405 € 800

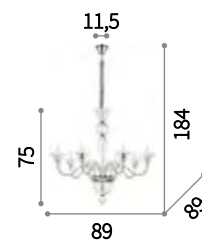

IP20

7,700 Kg / 0,1797 m³
E14 max 8 x 40W

199382 € 550
199412 € 590

3000 K / 430 Lm
101200 € 2,90

3000 K / 430 Lm
101200 € 2,90



Alexander

Lampadario in vetro trasparente soffiato e lavorato a mano. Montatura e dettagli in metallo rifinito in cromo. Copricatena in velluto.

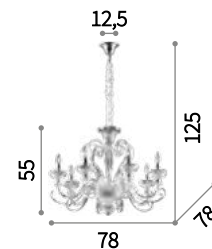

IP20

8,900 Kg / 0,1699 m³
E14 max 8 x 40W

090269 € 650

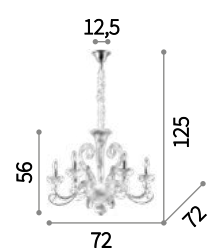

IP20

7,300 Kg / 0,1326 m³
E14 max 6 x 40W

090252 € 555

3000 K / 430 Lm
101224 € 2,90

3000 K / 430 Lm
101224 € 2,90



Baronet

Montatura in metallo dorato. Elementi decorativi in vetro soffiato e cristallo molato. Copricatena in velluto.

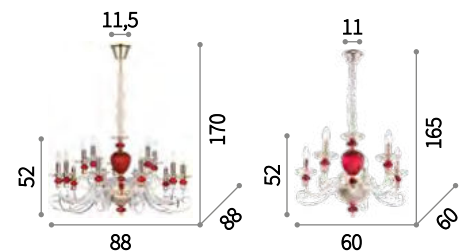

IP20

20,080 Kg / 0,2487 m³
E14 max 15 x 40W

168289 € 858

IP20

7,030 Kg / 0,1053 m³
E14 max 5 x 40W

168258 € 430

3000 K / 430 Lm
101224 € 2,90

3000 K / 430 Lm
101224 € 2,90



Strauss

Montatura e dettagli in metallo con finitura oro rosa. Bracci in vetro soffiato trasparente. Elementi decorativi in cristallo ambrato. Copricatena in velluto.

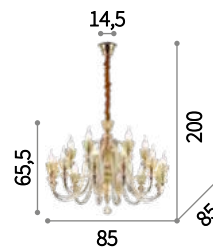

IP20

20,700 Kg / 0,4508 m³
E14 max 18 x 40W

140629 € 1.045

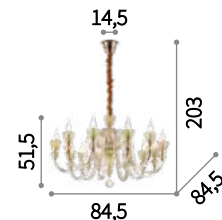

IP20

14,930 Kg / 0,3414 m³
E14 max 12 x 40W

140612 € 795

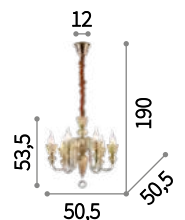

IP20

7,410 Kg / 0,1420 m³
E14 max 6 x 40W

140605 € 420



P. 505



3000 K / 430 Lm
101248 € 2,90



3000 K / 430 Lm
101248 € 2,90



3000 K / 430 Lm
101248 € 2,90

Ca' D'oro

Lampadario in vetro trasparente soffiato e lavorato a mano, rifinito con ambra in pasta di vetro. Coppa interna in metallo ottonato.

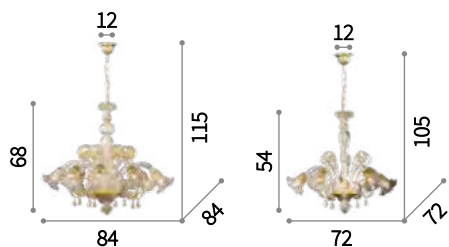

IP20

8,300 Kg / 0,1750 m³
E14 max 8 x 40W

020976 € 900

IP20

5,950 Kg / 0,1448 m³
E14 max 5 x 40W

020969 € 780

3000 K / 430 Lm
101200 € 2,90

3000 K / 430 Lm
101200 € 2,90



P. 506



Rialto

Lampadario in vetro trasparente soffiato e lavorato a mano, rifinito con ambra in pasta di vetro. La coppa interna è in metallo ottonato.

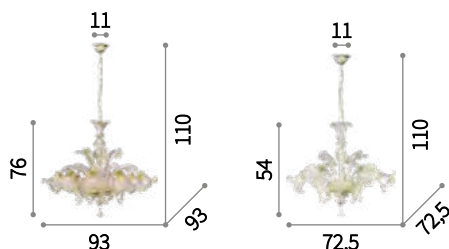

IP20

9,900 Kg / 0,1521 m³
E14 max 8 x 40W

004099 € 900

IP20

6,970 Kg / 0,1485 m³
E14 max 5 x 40W

009704 € 774

3000 K / 430 Lm
101200 € 2,90

3000 K / 430 Lm
101200 € 2,90





Radetzky

Lampadario in vetro soffiato e lavorato a mano. Dettagli in metallo cromato. Copricatena in velluto.

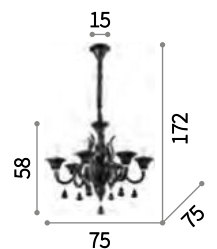

⏏ ⊕ IP20

9,460 Kg / 0,1826 m³

E14 max 6x40W

141084 ■ € 648

 3000 K / 430 Lm
101224 € 2,90



197791



Renoir

Lampadario in vetro soffiato con dettagli in metallo cromato. Pendagli in cristallo molato. Copricatena in velluto.



045672

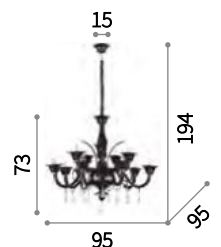

IP20

15,420 Kg / 0,1799 m³
E14 max 12 x 40W

197791 € 900
045672 € 900

3000 K / 430 Lm
101224 € 2,90

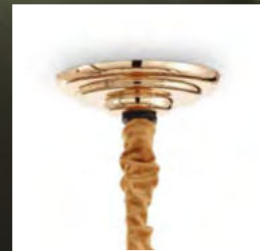

Vanity

Montatura in metallo dorato con dettagli nero opaco. Elementi decorativi in cristallo molato. Copricatena in velluto.

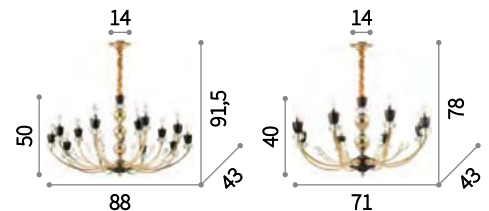

IP20

8,850 Kg / 0,2878 m³
E14 max 15 x 40W

206639 € 565

IP20

4,940 Kg / 0,1454 m³
E14 max 8 x 40W

206622 € 366

3000 K / 430 Lm
101224 € 2,90

3000 K / 430 Lm
101224 € 2,90

Maximilian

Lampadario lavorato a mano in vetro colorato bianco. Montatura e dettagli in metallo cromato. Copricatena in velluto.

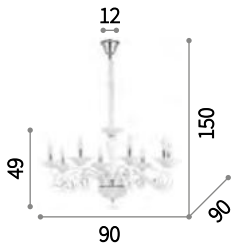

IP20

6,640 Kg / 0,1363 m³
E14 max 8 x 40W

111490 € 324

3000 K / 430 Lm
101224 € 2,90



Miramare

Lampadario in vetro trasparente e bianco soffiato e lavorato a mano. Copri portalampade e dettagli in metallo cromato. Copricatena in velluto.

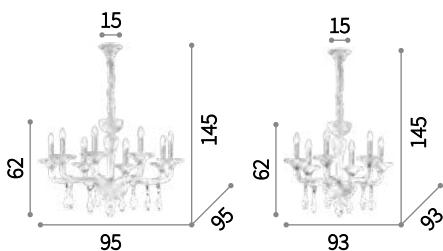

IP20

8,800 Kg / 0,1653 m³
E14 max 8 x 40W

068190 € 466

3000 K / 430 Lm
101224 € 2,90

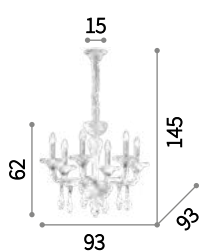

IP20

8,100 Kg / 0,1437 m³
E14 max 6 x 40W

068183 € 408

3000 K / 430 Lm
101224 € 2,90





Bon Bon

Montatura con bracci in fusione di metallo rifinito con vernice opaca bianca o nera. Bobeche in vetro soffiato nella versione bianca, in metallo in quella nera. Copricatena in velluto.

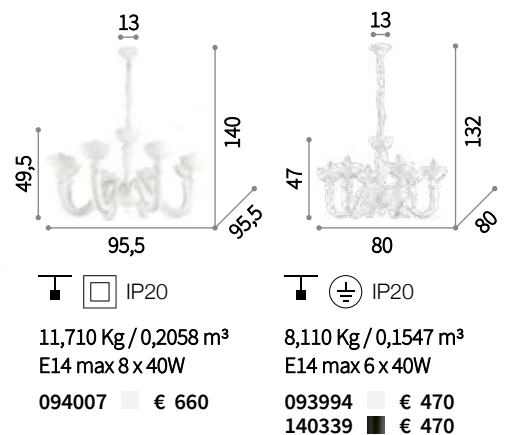

P. 506

3000 K / 360 Lm
101217 € 3,00

3000 K / 360 Lm
101217 € 3,00

White Lady

Lampadario in vetro soffiato lavorato a mano con copri portalampade e dettagli in metallo cromato. Copricatena in velluto.

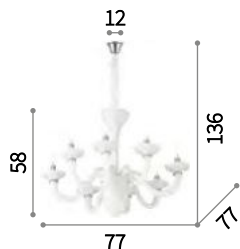

IP20

6,910 Kg / 0,1552 m³
E14 max 8 x 40W

019390 € 445

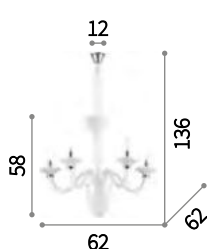

IP20

5,080 Kg / 0,1086 m³
E14 max 5 x 40W

019383 € 272



3000 K / 430 Lm
101224 € 2,90

3000 K / 430 Lm
101224 € 2,90



Windsor

Lampadario in vetro bianco soffiato e lavorato a mano con copri portalampade e dettagli in metallo cromato. Copricatena in velluto.

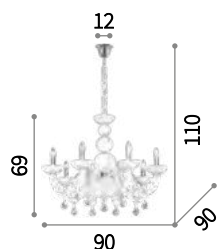

IP20

9,230 Kg / 0,2111 m³
E14 max 8 x 40W

022772 € 610



3000 K / 430 Lm
101224 € 2,90





Camelia

Lampadario in vetro soffiato e lavorato a mano. Montatura in metallo cromato. Bracci trasparenti. Bobeches e coppa centrale disponibili in bianco. Pendagli in cristallo molato trasparente. Cavi in acciaio a lunghezza regolabile da dispositivi automatici.

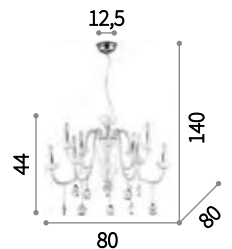

IP20

5,940 Kg / 0,1724 m³
E14 max 10 x 40W +
E27 max 1 x 60W

117782 € 545

3000 K / 430 Lm
101224 € 2,90

073453



Lilly

Lampadario in vetro soffiato trasparente e colorato lavorato artigianalmente. Dettagli in metallo cromato. Copricatena in velluto.



022789

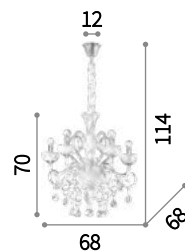

IP20

5,890 Kg / 0,1363 m³
E14 max 5 x 40W

022789 € 540
073453 € 575

3000 K / 430 Lm
101200 € 2,90



111896



Blanche

Montatura in metallo rifinito con smalto satinato bianco o nero. Paralumi in lamina di PVC rivestita di tessuto bianco o nero. Copricatena in velluto.



035581

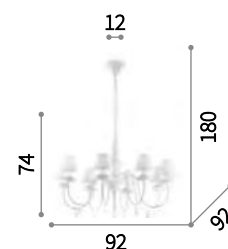

IP20

6,820 Kg / 0,1975 m³
E14 max 8 x 40W

035574 € 437
111896 € 437

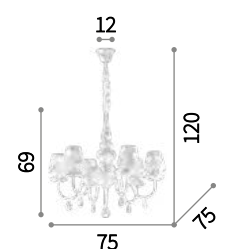

IP20

4,800 Kg / 0,1451 m³
E14 max 6 x 40W

035581 € 357
111872 € 357



P. 507

3000 K / 360 Lm
101231 € 3,00

3000 K / 360 Lm
101231 € 3,00



Accademy

Montatura in metallo cromato. Bobeches e pendagli in cristallo molato. Paralumi in lamina di PVC rivestita da fili neri. Copricatena in velluto.

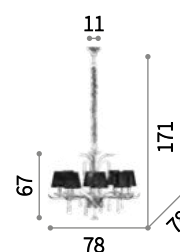

⏏ (⊕) IP20

8,290 Kg / 0,1617 m³
E14 max 8 x 40W

020594 || € 528

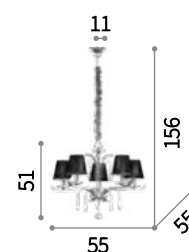



⏏ (⊕) IP20

5,610 Kg / 0,0979 m³
E14 max 5 x 40W

020600 || € 345



 3000 K / 430 Lm
101224 € 2,90

 3000 K / 430 Lm
101224 € 2,90



Pegaso

Montatura in metallo cromato oppure
ottone satinato. Corpo centrale, bobeches
e pendagli in cristallo molato. Paralumi in
organza. Copricatena in velluto.

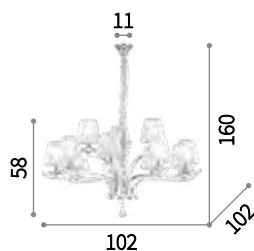

IP20

8,100 Kg / 0,3349 m³
E14 max 12 x 40W

066431 € 636
197746 € 725

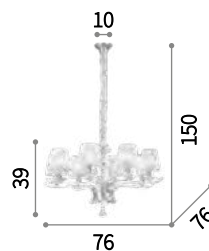

IP20

7,900 Kg / 0,2138 m³
E14 max 8 x 40W

059242 € 492
197739 € 575

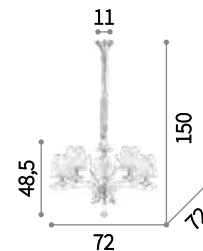

IP20

5,600 Kg / 0,1445 m³
E14 max 5 x 40W

066448 € 377
197722 € 414

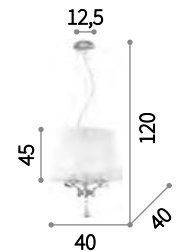

IP20

3,050 Kg / 0,0758 m³
E14 max 3 x 40W

059235 € 178
197715 € 205



P. 507



P. 537



P. 556



3000 K / 360 Lm
101231 € 3,00



3000 K / 360 Lm
101231 € 3,00



3000 K / 360 Lm
101231 € 3,00



3000 K / 360 Lm
101231 € 3,00



197746



Event

Montatura in metallo cromato. Elemento centrale e bobecche in vetro soffiato trasparente. Paralumi in vetro fumè con parte interna trasparente sabbiata. Copricatena in velluto.

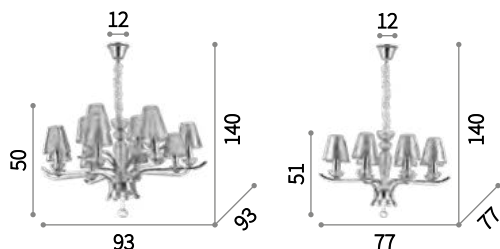

IP20

8,490 Kg / 0,2890 m³
E14 max 12 x 40W

115832 € 785

IP20

5,880 Kg / 0,1956 m³
E14 max 8 x 40W

115849 € 565

3000 K / 360 Lm
101231 € 3,00

3000 K / 360 Lm
101231 € 3,00



Terry

Lampadario in vetro trasparente soffiato e lavorato a mano. Montatura e dettagli in metallo cromato. Paralumi in vetro trasparente con parte centrale sabbiata. Pendenti con ottagononi e gocce in cristallo molato.

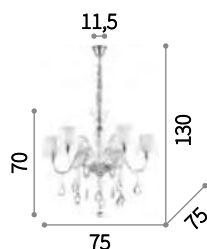

IP20

7,000 Kg / 0,1773 m³
E14 max 6 x 40W

112398 € 445

3000 K / 360 Lm
101231 € 3,00





088051

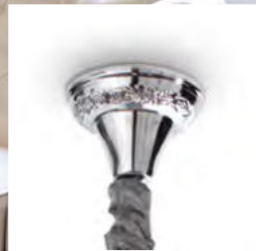

Pantheon

Montatura in metallo cromato o dorato.
 Elemento centrale con biglie in vetro.
 Pendagli e bobecche in cristallo molato.
 Paralume di tessuto con decorazione in
 rilievo e brillantini. Copricatena in velluto.

088068

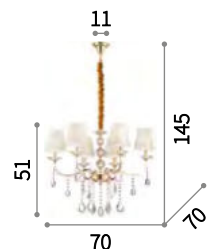

⏏ Ⓢ IP20

5,500 Kg / 0,0900 m³
 E14 max 6 x 40W

088051 € 467
 088068 € 496

 3000 K / 430 Lm
 101224 € 2,90



Violette

Montatura in metallo cromato con perle di vetro. Bobeches e pendagli in cristallo molato. Paralume in lamina di PVC, rivestita da fili in tessuto argentato.

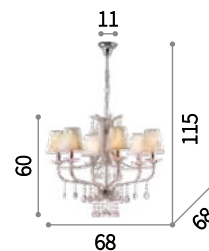

IP20

7,660 Kg / 0,2594 m³
E14 max 6 x 40W

015439 € 440



IP20

2,760 Kg / 0,0468 m³
E14 max 3 x 40W

018072 € 228

3000 K / 430 Lm
101224 € 2,90

3000 K / 430 Lm
101224 € 2,90

Senix

Montatura in metallo cromato. Paralumi in lamina di PVC rivestita di tessuto con fantasia floreale in rilievo. Bobeches e pendagli in cristallo molato. Copricatena in velluto.

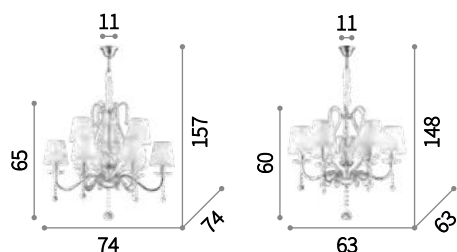



⏏ (⊕) IP20

6,840 Kg / 0,1094 m³
E14 max 9 x 40W
032610 € 550

⏏ (⊕) IP20

5,270 Kg / 0,0796 m³
E14 max 6 x 40W
032597 € 440

 3000 K / 360 Lm
101231 € 3,00

 3000 K / 360 Lm
101231 € 3,00



Romantik

Montatura in metallo rifinito argento antico. Bracci in vetro soffiato. Elementi decorativi in cristallo molato. Copricatena in velluto.

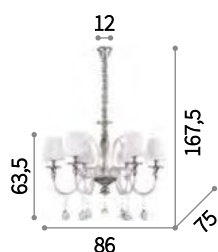

⏏ (⊕) IP20

7,690 Kg / 0,2757 m³
E14 max 6 x 40W
174945 € 726

 3000 K / 430 Lm
101224 € 2,90





Provence

Corpo luce in legno tornito e bracci in metallo. Finitura con vernice opaca. Paralumi in lamina di PVC rivestita in tessuto a trama grossa.

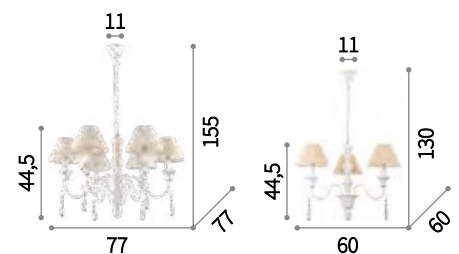

IP20

3,100 Kg / 0,0700 m³
E14 max 6 x 40W

003399 € 320

IP20

2,000 Kg / 0,0420 m³
E14 max 3 x 40W

025032 € 192



P. 531



P. 555



3000 K / 430 Lm
101224 € 2,90



3000 K / 430 Lm
101224 € 2,90

Spiga

Montatura ed elementi decorativi interamente in metallo. Paralumi in PVC rivestiti di tessuto.

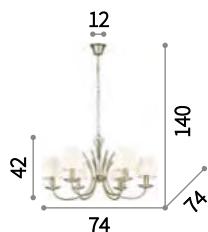

IP20

2,810 Kg / 0,2461 m³
E14 max 6 x 40W

168821 € 376

3000 K / 360 Lm
101231 € 3,00



Duca

Montatura in metallo cromato con mazza centrale e coppa ottenute da stampi. Diffusori in vetro pyrex cromato.

Lampadine alogene G9 28W 2700 K incluse.

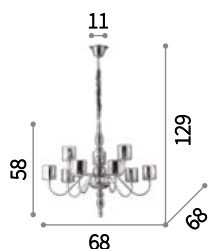

IP20

3,880 Kg / 0,0899 m³
G9 max 9 x 40W

031712 € 335

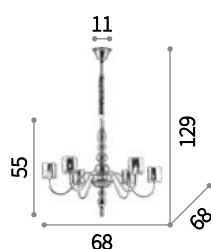

IP20

2,900 Kg / 0,0894 m³
G9 max 6 x 40W

004556 € 270

3000 K / 300 Lm
209043 € 3,50

3000 K / 300 Lm
209043 € 3,50





200071



Elisir

Montatura in metallo. Elementi decorativi a prisma in cristallo molato trasparente nella versione cromo, ambra in quella ottone.

LED Lampadine LED G9 3,2W 3000 K include. Cod. 209043



200002

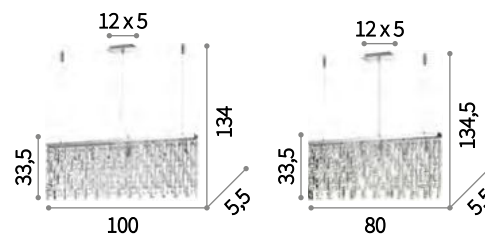

IP20

8,380 Kg / 0,0408 m³
G9 max 8 x 40W

200002 € 510
200071 € 530

IP20

6,370 Kg / 0,0325 m³
G9 max 6 x 40W

199993 € 450
200064 € 460



P. 473 P. 508 P. 536

3000 K / 300 Lm
209043 € 3,50

3000 K / 300 Lm
209043 € 3,50



166360



Martinez

Montatura in metallo cromato o dorato.
Elementi decorativi con catene di ottoni
e barre in cristallo molato trasparente.

213583

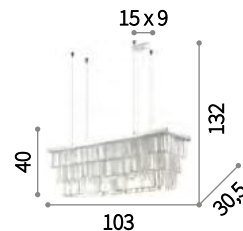

⏏ ⊕ IP20

17,600 Kg / 0,1129 m³
E14 max 8 x 40W

166360 ⏏ € 607
213583 ⏏ € 638

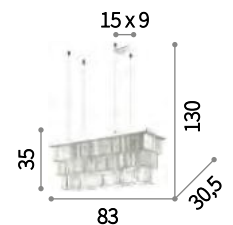

⏏ ⊕ IP20

14,490 Kg / 0,0723 m³
E14 max 6 x 40W

166322 ⏏ € 544



P. 473 P. 508

⏏ 3000 K / 430 Lm
101224 € 2,90

⏏ 3000 K / 430 Lm
101224 € 2,90



166247



Carlton

Montatura in metallo cromato o dorato.
Elementi decorativi con catene di ottoni
e barre in cristallo molato trasparente.



213521

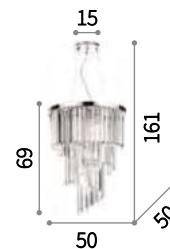

IP20

12,800 Kg / 0,1614 m³
E14 max 12 x 40W

166247 € 530
213521 € 562

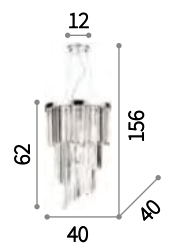

IP20

10,000 Kg / 0,1136 m³
E14 max 8 x 40W

117737 € 468

3000 K / 430 Lm
101224 € 2,90

3000 K / 430 Lm
101224 € 2,90



P. 474 P. 509

Elegant

Montatura in cromo. Canne in vetro trasparente con sezione a stella.

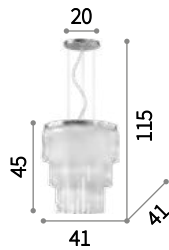

IP20

10,080 Kg / 0,1105 m³
E14 max 12 x 40W

026695 € 407



3000 K / 430 Lm
101224 € 2,90



P. 474

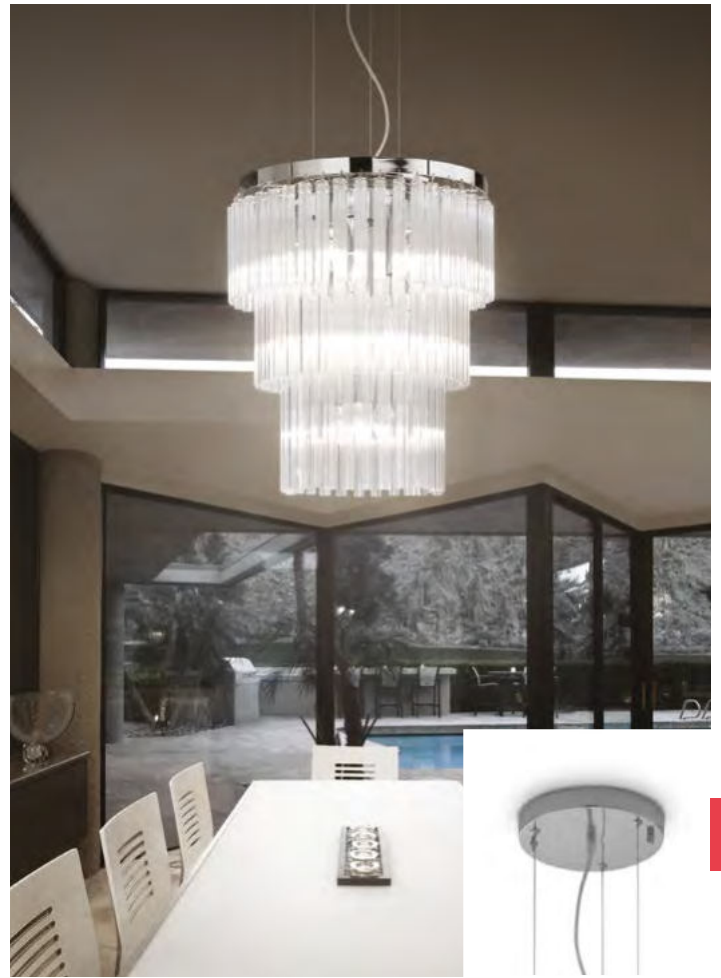

Majestic

Montatura circolare in metallo cromato. Elementi decorativi con canne di vetro modellate artigianalmente e fissate con clip a cavi metallici.

Lampadine alogene G9 28W 2700 K incluse.



IP20

16,700 Kg / 0,1526 m³
G9 max 10 x 40W

087269 € 850



3000 K / 300 Lm
209043 € 3,50



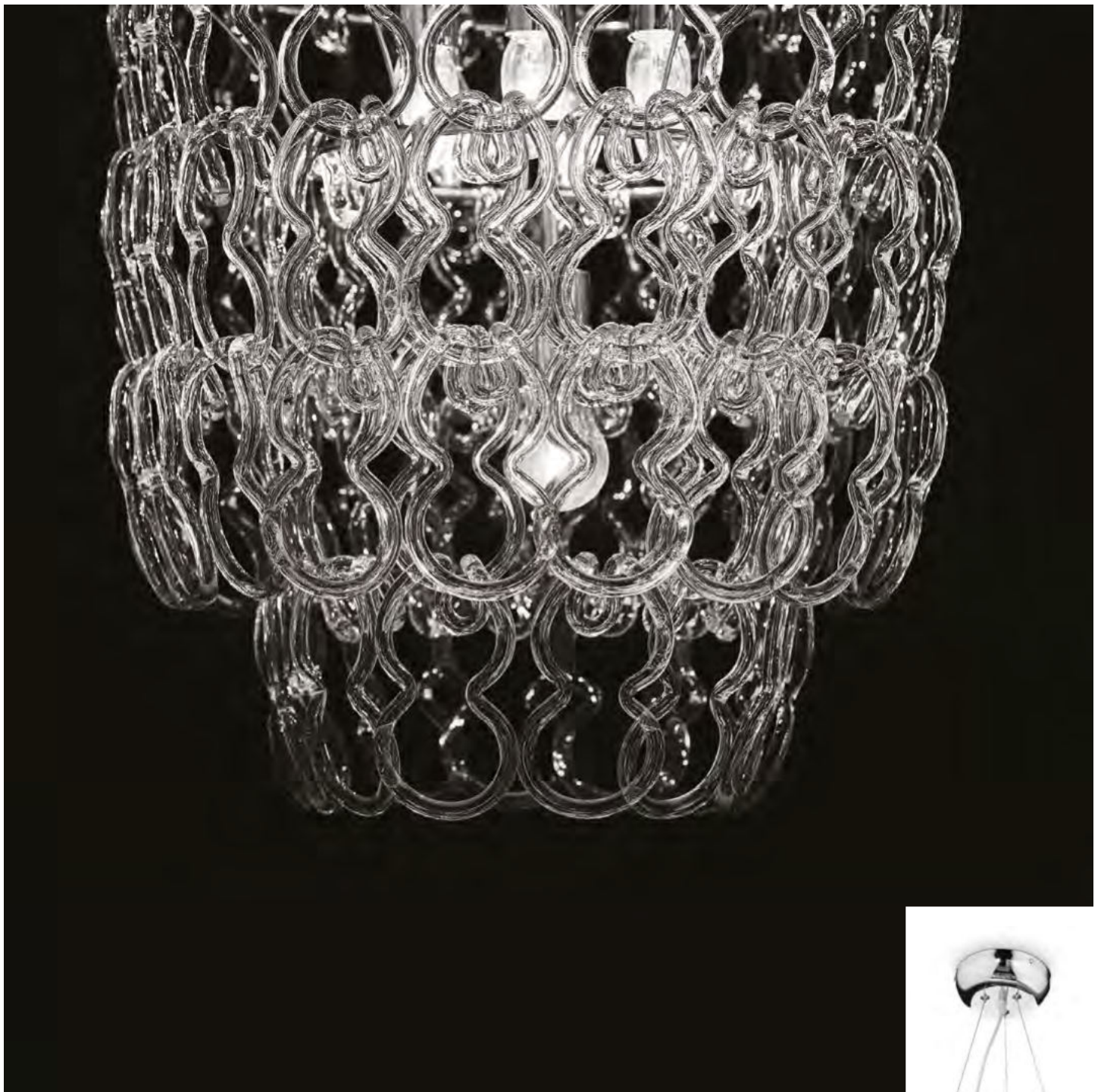

Alba

Montatura in cromo. Vetri in canna di pirex sagomati a mano e componibili a piacere. Sospensioni con cavi in acciaio a lunghezza regolabile da dispositivi automatici.

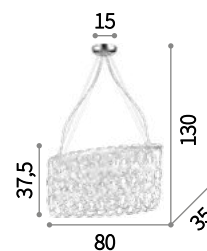

IP20

8,690 Kg / 0,0827 m³
E14 max 7 x 40W

007151 € 462



IP20

10,550 Kg / 0,1102 m³
E14 max 6 x 40W +
E27 max 1 x 60W

020365 € 528



P. 476

3000 K / 430 Lm
101224 € 2,90

3000 K / 430 Lm
101224 € 2,90





Luxor

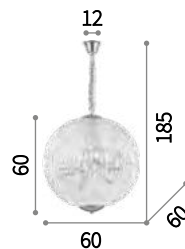

Montatura in metallo cromato. Diffusore con elementi decorativi ottagonali e rettangolari in cristallo molato. Copricatena in velluto.

 Lampadine alogene G9 28W 2700 K incluse.



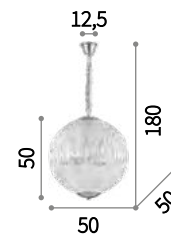



  IP20  INCLUSA
12,250 Kg / 0,3047 m³
G9 max 12 x 40W
116235 || € 972

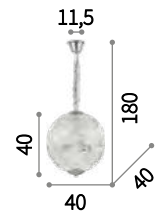



  IP20  INCLUSA
8,780 Kg / 0,2054 m³
G9 max 8 x 40W
116228 || € 780



  IP20  INCLUSA
8,340 Kg / 0,1260 m³
G9 max 6 x 40W
092911 || € 530

 3000 K / 300 Lm
209043 € 3,50

 3000 K / 300 Lm
209043 € 3,50

 3000 K / 300 Lm
209043 € 3,50



082196



Pashà

Montatura in metallo. Diffusore composto da filari di perle in cristallo molato e fondo chiuso da vetro circolare sabbato. Cavi in acciaio a lunghezza regolabile con dispositivi fermacavo automatici.



164984

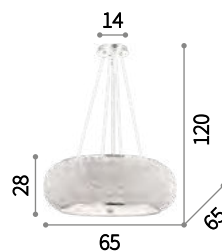

IP20

13,000 Kg / 0,1777 m³
E14 max 14 x 40W

164977 € 900
164984 € 945

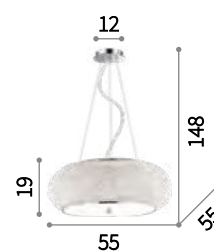

IP20

8,500 Kg / 0,1007 m³
E14 max 10 x 40W

082196 € 710
082257 € 732

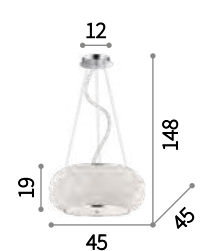

IP20

5,350 Kg / 0,0573 m³
E14 max 6 x 40W

082158 € 533
082172 € 554



P. 475 P. 509

3000 K / 430 Lm
101200 € 2,90

3000 K / 430 Lm
101200 € 2,90



3000 K / 430 Lm
101200 € 2,90

Evasione

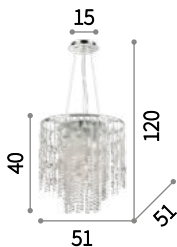

Pendagli in cristallo molato. Sospensioni con cavo in acciaio a lunghezza regolabile da dispositivo fermacavo automatico.

 Lampadine alogene G9 28W 2700 K incluse.



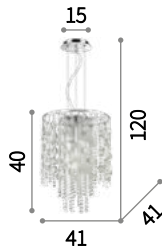

 IP20  INCLUSA
7,100 Kg / 0,1082 m³
G9 max 10 x 40W
044767  € 460



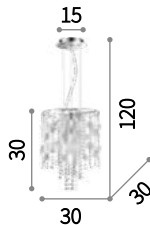



 IP20  INCLUSA
5,900 Kg / 0,0706 m³
G9 max 8 x 40W
044774  € 370





 IP20  INCLUSA
2,800 Kg / 0,0283 m³
G9 max 4 x 40W
062211  € 198



 3000 K / 300 Lm
209043  € 3,50

 3000 K / 300 Lm
209043  € 3,50



 3000 K / 300 Lm
209043  € 3,50

Audi-77

Pendagli ottagonali e tondi in cristallo molato. Sospensioni con cavi a lunghezza regolabile da dispositivi automatici.

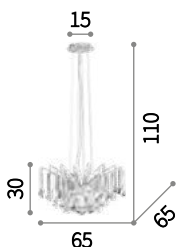
 Lampadine alogene G9 28W 2700 K incluse.





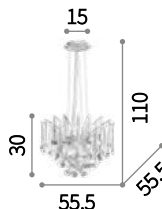

 IP20  INCLUSA
6,550 Kg / 0,1347 m³
G9 max 8 x 40W
020556  € 460



 IP20  INCLUSA
5,230 Kg / 0,1044 m³
G9 max 6 x 40W
019499  € 388



 3000 K / 300 Lm
209043  € 3,50

 3000 K / 300 Lm
209043  € 3,50



Pearl

Rosone e montatura in metallo cromato.
Elementi decorativi con catene di ottoni
in cristallo molato.



IP20

4,280 Kg / 0,0524 m³
E14 max 6 x 40W

211558 € 435

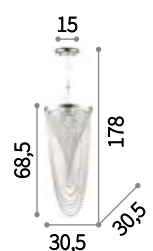

IP20

2,850 Kg / 0,0275 m³
E14 max 4 x 40W

211541 € 335

3000 K / 430 Lm
101224 € 2,90

3000 K / 430 Lm
101224 € 2,90



215969

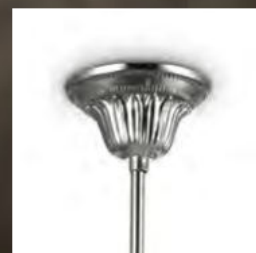

Dubai new

Montatura in metallo cromato o dorato.
Elementi decorativi con perle, ottagoni e
prismi in cristallo molato trasparente.



207216

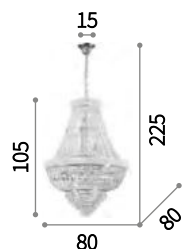

IP20

20,000 Kg / 0,7875 m³
E14 max 24 x 40W

243597 € 1.250 new
243528 € 1.300 new



IP20

9,170 Kg / 0,2723 m³
E14 max 10 x 40W

215969 € 840
207216 € 880

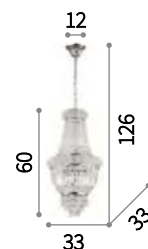

IP20

4,990 Kg / 0,0917 m³
E14 max 5 x 40W

207193 € 440
200965 € 460



P. 476



P. 510



3000 K / 430 Lm
101224 € 2,90



3000 K / 430 Lm
101224 € 2,90



3000 K / 430 Lm
101224 € 2,90



114743



Caesar

Montatura in metallo con finitura in oro o cromo. Elementi decorativi in cristallo molato ottagonali con finali a puntale.

 Lampadine alogene G9 28W
2700 K include.



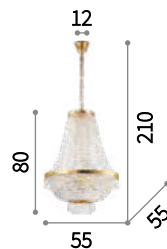

033532



  IP20 

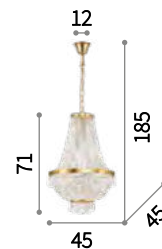

9,600 Kg / 0,2965 m3
G9 max 12 x 40W

114279  € 887
114743  € 924



  IP20 

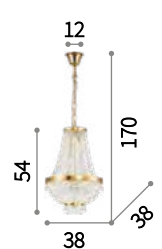

6,700 Kg / 0,2253 m3
G9 max 9 x 40W

041827  € 760
114736  € 804



  IP20 

5,100 Kg / 0,1175 m3
G9 max 6 x 40W

033532  € 515
114729  € 540





P. 477



P. 510

 3000 K / 300 Lm
209043 € 3,50

 3000 K / 300 Lm
209043 € 3,50

 3000 K / 300 Lm
209043 € 3,50



112800



Augustus

Montatura in metallo cromato o dorato.
Elementi decorativi con perle di cristallo
molato.

 Lampadine alogene G9 28W 2700 K
includi.



113197

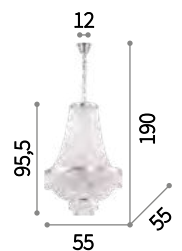

 IP20 

9,840 Kg / 0,3114 m³
G9 max 12x40W

112800  € 1.000
113197  € 1.000



 3000 K / 300 Lm
209043 € 3,50



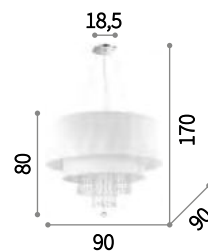

Opera

Montatura in cromo. Paralume in lamina di PVC con riflessi metallizzati e rivestita da fili. Pendagli in cristallo molato. Sospensioni con cavi in acciaio a lunghezza regolabile.

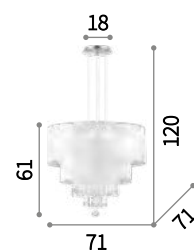

 IP20
 6,880 Kg / 0,3322 m³
 E27 max 10 x 60W
 165011 ■ € 645



 IP20
 7,450 Kg / 0,1652 m³
 E27 max 6 x 60W
 068299 ■ € 395
 122601 ■ € 395
 103327 ■ € 395

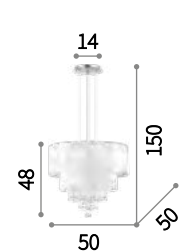

 IP20
 2,780 Kg / 0,0646 m³
 E27 max 4 x 60W
 182179 ■ € 275



P. 511



P. 536



P. 554



3000 K / 720 Lm
123899 € 6,90



3000 K / 720 Lm
123899 € 6,90



3000 K / 720 Lm
123899 € 6,90

068275





035826



Swan

Montatura in cromo. Corpo luce in vetro soffiato e lavorato a mano. Elementi decorativi in cristallo molato. Paralume in tessuto d'organza plissettato. Copricatena in velluto.



208152

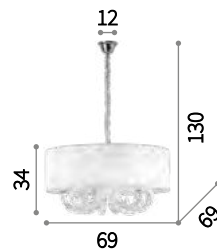

IP20

6,420 Kg / 0,2708 m³
E14 max 6 x 40W

035826 € 455
208152 € 455

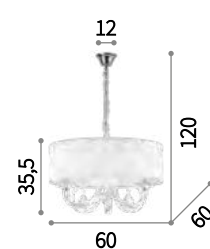

IP20

4,770 Kg / 0,1632 m³
E14 max 3 x 40W

035840 € 315
208497 € 315



P. 511

3000 K / 360 Lm
101217 € 3,00

3000 K / 360 Lm
101217 € 3,00

Paris

Montatura in nickel satinato. Bobeches in cristallo molato. Paralume in lamina di PVC rivestita da fili argentati. Sospensione con cavi in acciaio a lunghezza regolabile.

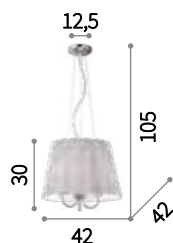

IP20

2,280 Kg / 0,0794 m³
E14 max 3 x 40W

018010 ■ € 168

3000 K / 430 Lm
101200 € 2,90



Queen

Montatura in metallo dorato con elementi decorativi e base in cristallo molato. Paralume in lamina di PVC, rivestita in tessuto con decorazione trapuntata e brillantini dorati.



IP20

3,300 Kg / 0,0920 m³
E14 max 3 x 40W

079400 ■ € 200

3000 K / 430 Lm
101200 € 2,90





Harem

Montatura con decori in rilievo in metallo brunito e ottagononi in cristallo molato incastonati. Diffusori in vetro soffiato trasparente leggermente ambrato con pendaglio a nappa. Copricatena in velluto.

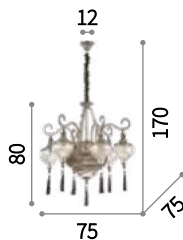

IP20

8,550 Kg / 0,2571 m³
E27 max 9 x 60W
116006 € 900

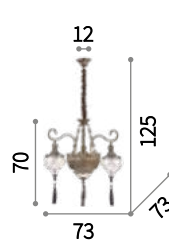

IP20

4,600 Kg / 0,1346 m³
E27 max 5 x 60W
115993 € 580



IP20

3,150 Kg / 0,0604 m³
E27 max 3 x 60W
115986 € 320

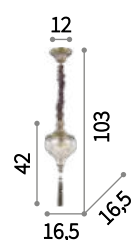

IP20

0,980 Kg / 0,0228 m³
E27 max 1 x 60W
115979 € 130



P. 479



P. 512



3000 K / 860 Lm
119571 € 6,50



3000 K / 860 Lm
119571 € 6,50



3000 K / 860 Lm
119571 € 6,50



3000 K / 860 Lm
119571 € 6,50



Hamмам

Montatura in metallo rifinito argento.
 Diffusori in vetro soffiato trasparente.
 Pendagli a nappa. Copricatena in velluto.

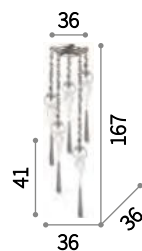

IP20

4,030 Kg / 0,1752 m³
 E14 max 5 x 40W

139586 ■ € 425

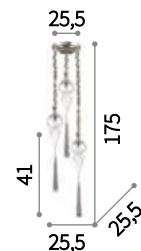

IP20

2,530 Kg / 0,0852 m³
 E14 max 3 x 40W

135823 ■ € 255

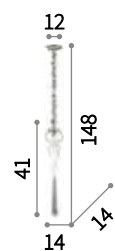

IP20

0,840 Kg / 0,0264 m³
 E14 max 1 x 40W

135816 ■ € 85



P. 512



3000 K / 430 Lm
 101200 € 2,90



3000 K / 430 Lm
 101200 € 2,90



3000 K / 430 Lm
 101200 € 2,90



Nawa

Montatura e diffusore in metallo traforato con finitura effetto argento.

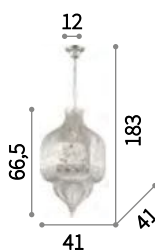

IP20

4,010 Kg / 0,1634 m³
E27 max 8 x 60W

141954 ■ € 526

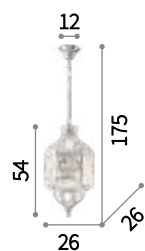

IP20

2,760 Kg / 0,0852 m³
E27 max 3 x 60W

141923 ■ € 360

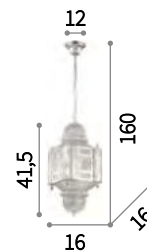

IP20

2,100 Kg / 0,0368 m³
E27 max 1 x 60W

138343 ■ € 232

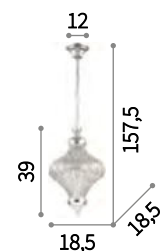

IP20

1,350 Kg / 0,0368 m³
E27 max 1 x 60W

140827 ■ € 157

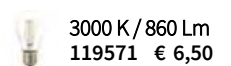
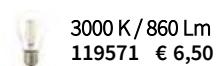
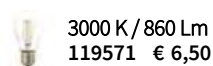
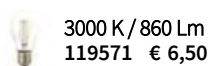



Kronplatz

Montatura in metallo cromato. Paralume in lamina di PVC rivestita con tessuto canvas. Sospensioni con cavi in acciaio a lunghezza regolabile da dispositivi automatici.

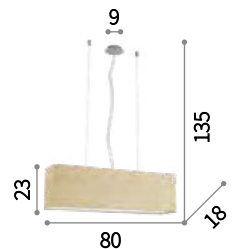

IP20

1,590 Kg / 0,0520 m³
E14 max 4 x 40W

110899 € 150



P. 530

P. 551

3000 K / 430 Lm
101200 € 2,90



Amaca

Rosone in metallo verniciato bianco opaco. Cavo avvolto da corde. Paralume con tessuto naturale intercambiabile e lavabile.

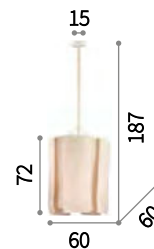

IP20

1,570 Kg / 0,0234 m³
E27 max 1 x 60W

207650 € 150

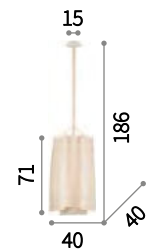

IP20

1,160 Kg / 0,0117 m³
E27 max 1 x 60W

207636 € 104

3000 K / 860 Lm
101347 € 8,90

3000 K / 860 Lm
101347 € 8,90



Haunt

Rosone in metallo verniciato bianco opaco. Cavo in tessuto. Diffusore con cesto in vimini al naturale o verniciato in bianco.

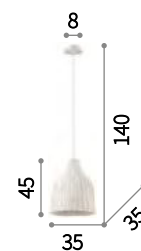

IP20

0,460 Kg / 0,0622 m³
E27 max 1x60W

159256 € 130
159812 € 130

3000 K / 860 Lm
101347 € 8,90



Canapa

Montature metalliche e cavi elettrici rivestiti interamente in corda di canapa naturale.

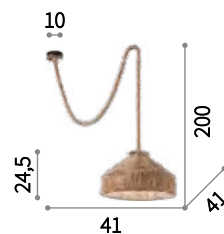

IP20
 2,190 Kg / 0,0944 m³
 E27 max 1 x 15W
 134833 € 150



IP20
 0,650 Kg / 0,0063 m³
 E27 max 2 x 15W
 134840 € 52

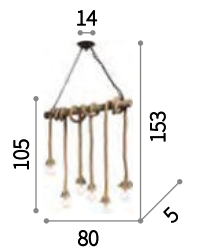

IP20
 2,410 Kg / 0,0254 m³
 E27 max 6 x 15W
 134826 € 147

3000 K / 860 Lm
 119571 € 6,50

3000 K / 860 Lm
 119571 € 6,50

3000 K / 860 Lm
 119571 € 6,50



Corda

Montatura e dettagli in metallo verniciato nero opaco con parti rivestite in corda di canapa naturale.

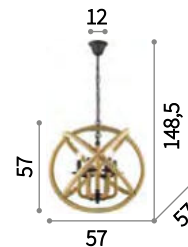

IP20

4,550 Kg / 0,2084 m³
E14 max 6 x 40W

130910 € 272

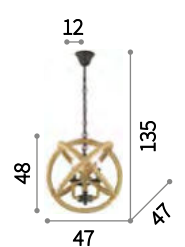

IP20

3,580 Kg / 0,1351 m³
E14 max 3 x 40W

130903 € 192

3000 K / 430 Lm
101200 € 2,90

3000 K / 430 Lm
101200 € 2,90

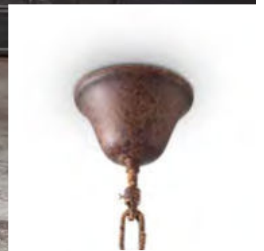

Millennium

Montatura e dettagli in metallo verniciato con effetto ruggine. Elementi decorativi centrali in legno naturale antichizzato.

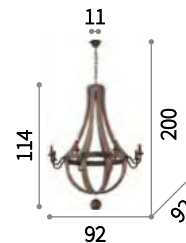

IP20

8,330 Kg / 1,0291 m³
E14 max 8 x 40W

129709 € 1.072

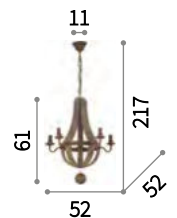

IP20

2,670 Kg / 0,2695 m³
E14 max 5 x 40W

129921 € 390

3000 K / 430 Lm
101224 € 2,90

3000 K / 430 Lm
101224 € 2,90



Monet

Montatura in metallo con fasce circolari decorate a sbalzo. Catene con perle in legno naturale. Finitura con vernice opaca bianca.



IP20

6,700 Kg / 0,0534 m³
E14 max 6 x 40W

162751 € 398

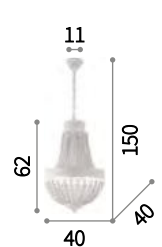

IP20

5,300 Kg / 0,0387 m³
E14 max 5 x 40W

162737 € 304

3000 K / 360 Lm
101217 € 3,00

3000 K / 360 Lm
101217 € 3,00



Chalet

Montatura con struttura portante in metallo. Elementi decorativi in resina lavorata artigianalmente e dipinta a mano come fedele riproduzione di corna e legno intagliato.

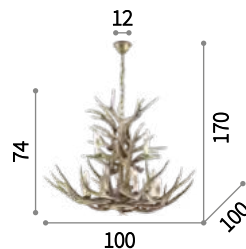

IP20

14,650 Kg / 0,2100 m³
E14 max 12 x 40W

113975 € 880

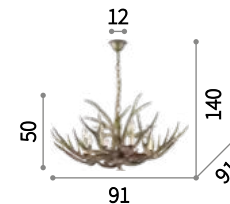

IP20

8,350 Kg / 0,1535 m³
E14 max 8 x 40W

115504 € 660

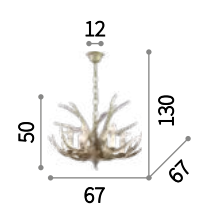

IP20

5,700 Kg / 0,2270 m³
E14 max 6 x 40W

115498 € 550



P. 513



P. 530



3000 K / 430 Lm
101224 € 2,90



3000 K / 430 Lm
101224 € 2,90



3000 K / 430 Lm
101224 € 2,90



Driftwood

Montatura in metallo. Elementi decorativi con rami di legno naturale.

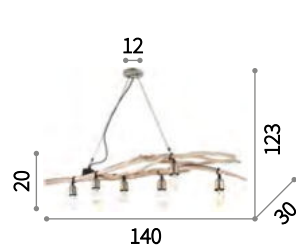

IP20

4,500 Kg / 0,1402 m³
E27 max 6 x 60W

180922 € 370

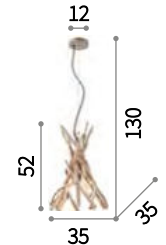

IP20

1,240 Kg / 0,0599 m³
E27 max 1 x 60W

129600 € 260



P. 532

P. 553

2200 K / 300 Lm
151687 € 4,90

2200 K / 300 Lm
151687 € 4,90

Volterra

Rosone e bracci in metallo con finitura rustica. Corpo luce ed elementi decorativi in legno naturale intagliato e dipinto a mano.

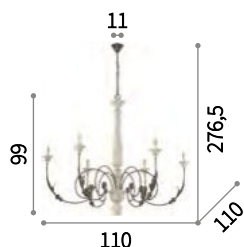

IP20

7,450 Kg / 0,2520 m³
E14 max 6 x 40W

166483 € 1.100

3000 K / 430 Lm
101248 € 2,90



Pisa

Montatura e bracci in metallo. Decorato a mano con foglia d'oro e antichizzato.

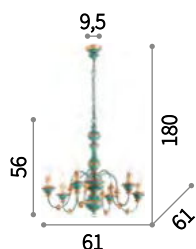

IP20

4,640 Kg / 0,0881 m³
E14 max 6 x 40W

093550 € 322

3000 K / 430 Lm
101224 € 2,90



Giglio

Montatura con struttura portante in metallo. Corpo luce in resina modellata con tecniche artigianali che riproducono fedelmente il legno intagliato. Decorato e antichizzato a mano con foglia d'oro.

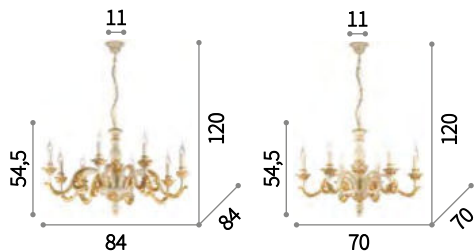

IP20

10,100 Kg / 0,1270 m³
E14 max 8 x 40W

075341 € 490

IP20

6,700 Kg / 0,0889 m³
E14 max 6 x 40W

075327 € 413

3000 K / 430 Lm
101248 € 2,90

3000 K / 430 Lm
101248 € 2,90



P. 513



Firenze

Corpo luce in resina. Bracci e foglie in metallo modellato artigianalmente. Decorato a mano con foglia d'oro e antichizzato.

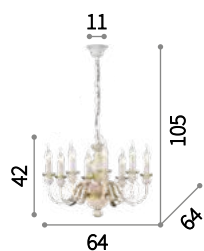

IP20

6,440 Kg / 0,0842 m³
E14 max 8 x 40W

012872 € 362
020839 € 362

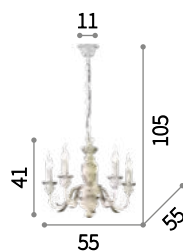

IP20

4,360 Kg / 0,0609 m³
E14 max 5 x 40W

012865 € 278
020822 € 278

3000 K / 430 Lm
101248 € 2,90

3000 K / 430 Lm
101248 € 2,90



012872



020839



P. 514



P. 531



P. 555



Palio

Corpo luce e dettagli in resina modellata con tecniche artigianali che riproducono fedelmente il legno intagliato. Bracci in metallo. Decorato e antichizzato a mano.

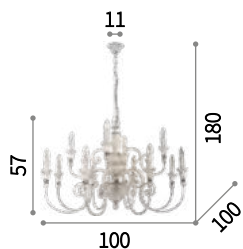

IP20

11,200 Kg / 0,3366 m³
E14 max 12 x 40W

093789 € 865

3000 K / 430 Lm
101224 € 2,90



Cortina

Montatura in metallo modellato artigianalmente. Elemento centrale e basi porta lampade in resina. Decorato a mano con effetto antichizzato.

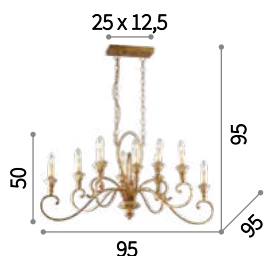

IP20

7,800 Kg / 0,1806 m³
E14 max 10 x 40W

088433 € 555

3000 K / 430 Lm
101224 € 2,90



Artù

Montatura in nickel con finitura lucida.
Alle estremità dei bracci, elementi decorativi in cristallo molato. Copricatena in velluto.

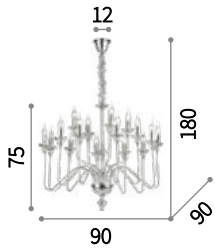

IP20

9,500 Kg / 0,4031 m³
E14 max 16 x 40W
073149 € 900

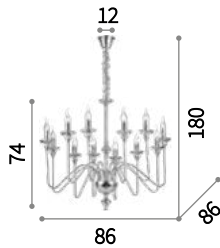
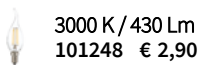

IP20

8,120 Kg / 0,3587 m³
E14 max 12 x 40W
073132 € 770

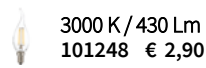

Camilla

Montatura ed elementi decorativi interamente in metallo modellato artigianalmente e dipinto a mano.

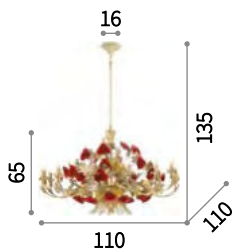

IP20

11,000 Kg / 0,8197 m³
E14 max 12 x 40W
173917 € 1.200

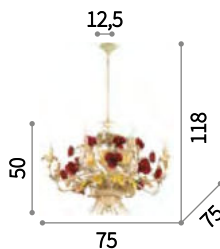
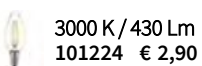

IP20

5,510 Kg / 0,2957 m³
E14 max 8 x 40W
168081 € 720

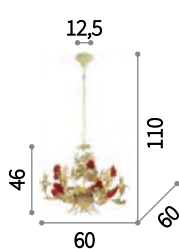
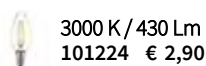

IP20

3,810 Kg / 0,1861 m³
E14 max 6 x 40W
168067 € 500

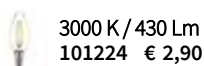

Tirol

Montatura in metallo decorato a mano in color ruggine. Elementi floreali in vetro trasparente lavorato a pinza. Vetri trasparenti con sfumatura in giallo tenue, rifiniti artigianalmente.

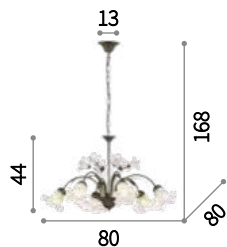

IP20

4,811 Kg / 0,0580 m³
E14 max 6 x 40W

024486 € 254

3000 K / 430 Lm
101200 € 2,90



P. 480



Valentina

Montatura in metallo lavorato e dipinto a mano in bianco antico con riflessi oro e dettagli in rosa e verde. Vetri satinati.

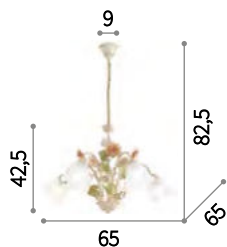

IP20

3,040 Kg / 0,1260 m³
E14 max 5 x 40W

220659 € 258

3000 K / 360 Lm
101231 € 3,00



P. 481





Foglia

Montatura in metallo decorato a mano di colore nero. Diffusore in vetro centrifugato con decorazioni in rilievo dipinte a mano.

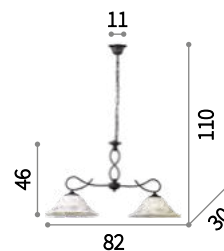

IP20

3,270 Kg / 0,1362 m³
E27 max 2x60W

021416 € 172

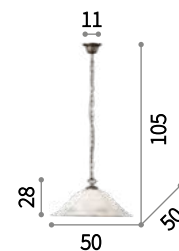

IP20

4,810 Kg / 0,0816 m³
E27 max 1x100W

021430 € 82

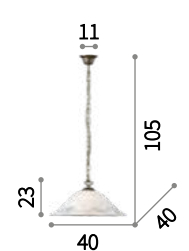

IP20

3,290 Kg / 0,0566 m³
E27 max 1x60W

007533 € 70



P. 481



P. 514



3000 K / 860 Lm
119571 € 6,50



3000 K / 860 Lm
119571 € 6,50



3000 K / 860 Lm
119571 € 6,50

Cascina

Montatura ed elementi decorativi a foglia in metallo lavorato artigianalmente. Decorato a mano con vernice bianca e oro.

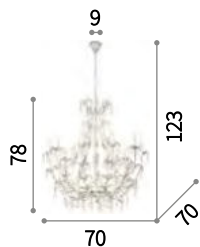

IP20

7,400 Kg / 0,3810 m³
E14 max 10 x 40W

100302 € 545

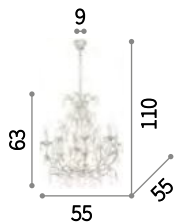

IP20

4,000 Kg / 0,3169 m³
E14 max 8 x 40W

100289 € 320

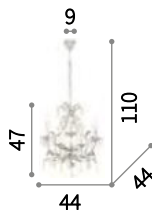

IP20

2,300 Kg / 0,1648 m³
E14 max 5 x 40W

100272 € 205

3000 K / 430 Lm
101224 € 2,90

3000 K / 430 Lm
101224 € 2,90

3000 K / 430 Lm
101224 € 2,90



Justine

Rosone e montatura in metallo con bracci in fusione. Rifinito con vernice opaca bianca. Copricatena in velluto.

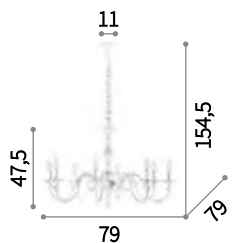

IP20

4,550 Kg / 0,3281 m³
E14 max 8 x 40W

197524 € 420

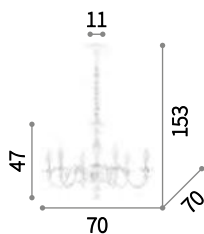

IP20

3,440 Kg / 0,2592 m³
E14 max 6 x 40W

197500 € 320

3000 K / 430 Lm
101248 € 2,90

3000 K / 430 Lm
101248 € 2,90





Corte

Montatura completamente in metallo modellato con lavorazione artigianale. Finitura dipinta a mano con effetto antichizzato. Disponibile nella versione bianca o ruggine.

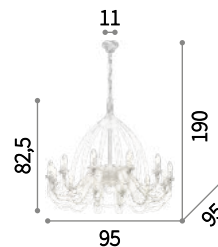

IP20

7,100 Kg / 0,6840 m³
E14 max 12 x 40W

097664 € 293
097671 € 293



IP20

5,220 Kg / 0,3169 m³
E14 max 8 x 40W

005898 € 210
057194 € 210

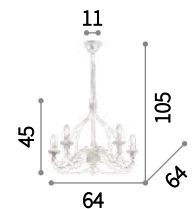

IP20

3,180 Kg / 0,1500 m³
E14 max 5 x 40W

005881 € 132
057187 € 132



3000 K / 430 Lm
101224 € 2,90

3000 K / 430 Lm
101224 € 2,90

3000 K / 430 Lm
101224 € 2,90



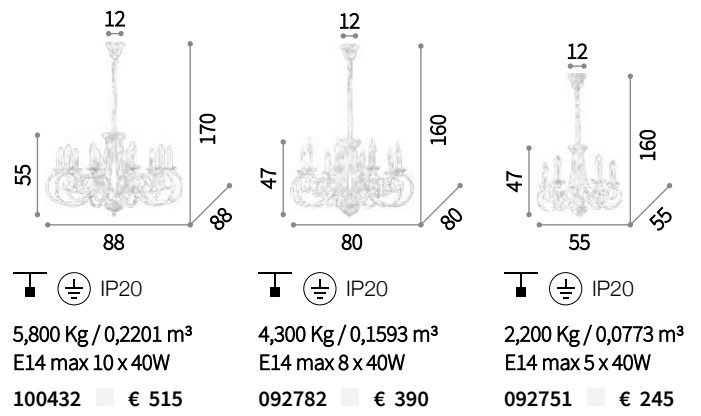

Sem

Montatura completamente in metallo modellato con lavorazione artigianale. Rifinito con vernice satinata bianca.



 3000 K / 430 Lm
101224 € 2,90

 3000 K / 430 Lm
101224 € 2,90

 3000 K / 430 Lm
101224 € 2,90



Brandy

Montatura completamente in metallo modellato con lavorazione artigianale. Dipinto a mano con effetto antichizzato.



IP20

2,500 Kg / 0,1109 m³
E14 max 8 x 40W

066639 € 238

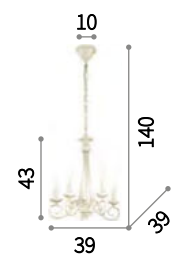

IP20

2,200 Kg / 0,0496 m³
E14 max 5 x 40W

066622 € 138

3000 K / 430 Lm
101224 € 2,90

3000 K / 430 Lm
101224 € 2,90

Potty

Rosone in metallo verniciato nero opaco. Cavo rivestito in corda. Diffusori con vasi in vetro soffiato trasparente.

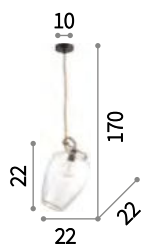

1,600 Kg / 0,0459 m³
E27 max 1 x 60W

158709 € 90

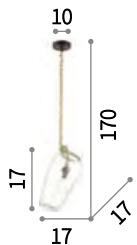

1,070 Kg / 0,0313 m³
E27 max 1 x 60W

158785 € 90

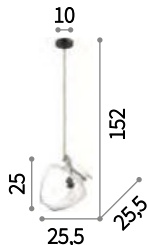

1,840 Kg / 0,0545 m³
E27 max 1 x 60W

158808 € 90

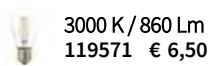
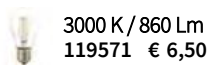
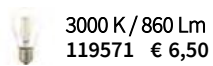

Entry

Montatura e dettagli in metallo rifinito con vernice nera opaca. Diffusore in vetro soffiato trasparente.

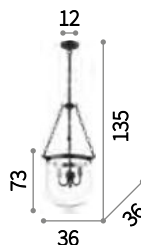

3,230 Kg / 0,0781 m³
E14 max 3 x 40W

134215 € 245

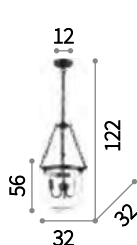

2,500 Kg / 0,0493 m³
E14 max 3 x 40W

134208 € 210

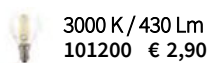
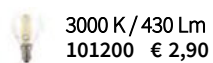



094786



Norma

Montatura in metallo con finitura in cromo o in brunito. Diffusore composto da lastre di vetro trasparente con bordo molato. Copricatena in velluto.



005911

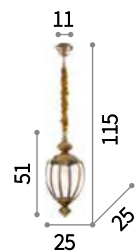

⏏ Ⓢ IP20

2,620 Kg / 0,0286 m³
E27 max 1x60W

094786  € 160
005911  € 160



P. 479



P. 515

 3000 K / 430 Lm
101279 € 2,90



Stella

Montatura in metallo modellata artigianalmente. Diffusore composto di lastre di vetro trasparente incastonate nella struttura metallica. Porzione apribile per la sostituzione della lampadina.

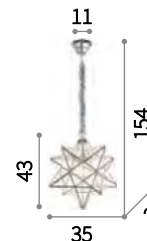

IP20

3,100 Kg / 0,0968 m³
E27 max 1 x 60W

093079 € 246

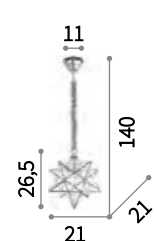

IP20

1,600 Kg / 0,0226 m³
E27 max 1 x 60W

093000 € 137

3000 K / 860 Lm
119571 € 6,50

3000 K / 860 Lm
119571 € 6,50

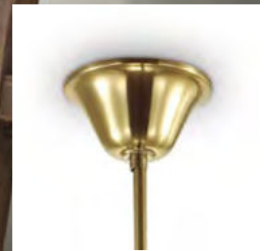

Deca

Montatura in metallo con finitura in brunito. Diffusore in lastre di vetro trasparente, apribile per sostituzione lampadina.

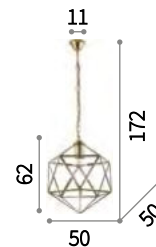

IP20

6,720 Kg / 0,2288 m³
E27 max 1 x 60W

168869 ■ € 330

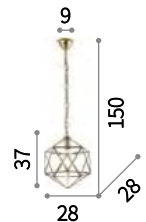

IP20

2,580 Kg / 0,0671 m³
E27 max 1 x 60W

168852 ■ € 175

2200 K / 300 Lm
151724 € 7,90

2200 K / 300 Lm
151717 € 6,90

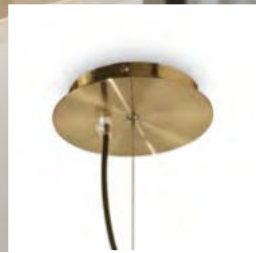

Orangerie

Montatura in metallo rifinito brunito.
Diffusore in lastre di vetro trasparente.
Cavo in tessuto nero.



IP20

5,000 Kg / 0,1221 m³
E27 max 1 x 60W

160085 ■ € 296

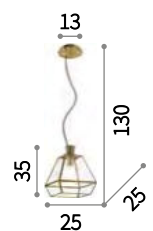

IP20

2,200 Kg / 0,0414 m³
E27 max 1 x 60W

152776 ■ € 168

3000 K / 860 Lm
119571 € 6,50

3000 K / 860 Lm
119571 € 6,50



Rondo

Montatura in metallo con finitura in brunito. Diffusore in lastre di vetro trasparente. Cavo in acciaio regolabile in lunghezza.

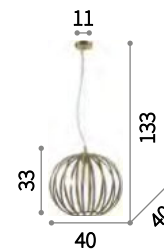

IP20

3,910 Kg / 0,1237 m³
E27 max 1 x 60W

168968 ■ € 368

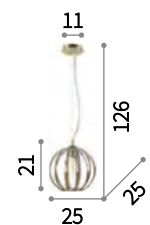

IP20

1,970 Kg / 0,0403 m³
E27 max 1 x 60W

168951 ■ € 194

 2200 K / 300 Lm
151724 € 7,90

 2200 K / 300 Lm
151717 € 6,90

Maglie

Rosone e montatura a gabbia in metallo verniciato nero opaco. Diffusore in vetro bianco soffiato artigianalmente.

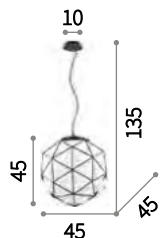

5,160 Kg / 0,1565 m³
E27 max 1 x 60W

159263 ■ € 323

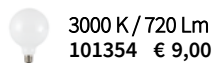

Anfora

Montatura in metallo sagomato artigianalmente e smaltato nero. Diffusore in vetro trasparente soffiato a mano.

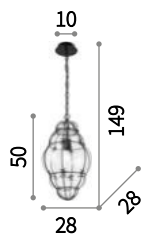

3,340 Kg / 0,0846 m³
E27 max 1 x 42W

131795 ■ € 130

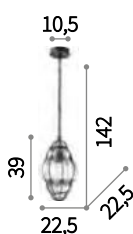

1,940 Kg / 0,0497 m³
E27 max 1 x 42W

131788 ■ € 100

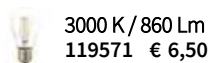
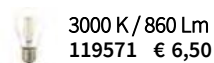



Kyoto

Rosone e montatura in metallo verniciato nero opaco. Diffusore con lastre di vetro trasparente satinato.

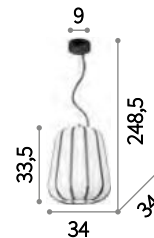

■ □ IP20

3,980 Kg / 0,0848 m³
E27 max 1 x 60W

208282 ■ € 312

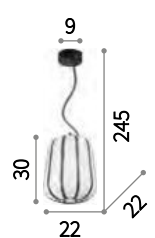

■ □ IP20

2,700 Kg / 0,0468 m³
E27 max 1 x 60W

208299 ■ € 208

3000 K / 720 Lm
101330 € 8,50

3000 K / 720 Lm
123899 € 6,90

Classico

Lampade da soffitto



Culto 470



Triumph 470



Spark 471



Lingotto 471

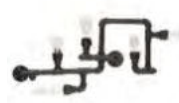

Plumber 472



Elisir 473



Martinez 473



Pashà 475



Alba 476



Dubai 476



Caesar 477



Magnolia 477



Bijoux 478



Harem 479



Valentina 481



Foglia 481



Tintoretto 482



Shell 483



Winery 484



Bob Mini 484



Maracas 485



Carlton 474



Elegant 474



Norma 479



Tirol 480



Polka 485



Magnolia

Pag 477

Culto new

Montatura in metallo verniciato nero opaco e base con elemento in ottone satinato. Diffusori in vetro soffiato bianco, acidato.

LED Lampadine LED G9 3,2W 3000 K incluse. Cod. 209043

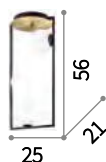

IP20

1,620 Kg / 0,0484 m³
G9 max 3x28W

225128 ■ € 210 new

3000 K / 300 Lm
209043 € 3,50



P. 331



P. 489



P. 522



P. 547



Triumph new

Montatura interamente in metallo con finitura nero o ottone invecchiato.

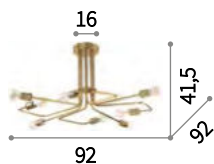

IP20

3,270 Kg / 0,0454 m³
E27 max 8 x 60W

160313 ■ € 435

242378 ■ € 405 new

2200 K / 300 Lm
151687 € 4,90



P. 336



P. 490



160313

Spark new

Montatura in metallo verniciato nero opaco con portalampane placcati.

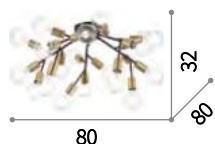

■ □ IP20

2,730 Kg / 0,0864 m³
E27 max 20 x 60W

238333 ■ € 330 new



3000 K / 860 Lm
101323 € 7,90



P. 327

Lingotto

Montatura in metallo verniciato: base nera opaca e telaio ottone opaco. Diffusori in vetro incamiciato bianco, soffiato e acidato.

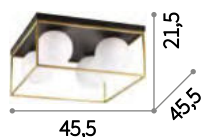

■ ⊕ IP20

5,580 Kg / 0,0540 m³
E14 max 4 x 40W

198156 ■ € 247

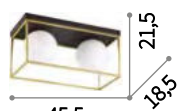

■ ⊕ IP20

3,370 Kg / 0,0451 m³
E14 max 2 x 40W

198149 ■ € 164

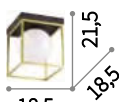

■ ⊕ IP20

1,810 Kg / 0,0183 m³
E14 max 1 x 40W

198132 ■ € 100

3000 K / 360 Lm
101217 € 3,00

3000 K / 360 Lm
101217 € 3,00

3000 K / 360 Lm
101217 € 3,00



P. 337



Plumber

Montatura con elementi idraulici in metallo. Finiture: nero opaco o nero antichizzato.



136707



175324

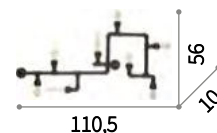

IP20

5,570 Kg / 0,1076 m³
E27 max 8 x 42W

175331 ■ € 320
136714 ■ € 320

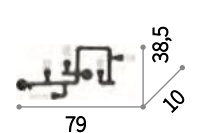

IP20

4,180 Kg / 0,0504 m³
E27 max 5 x 42W

175324 ■ € 215
136707 ■ € 215

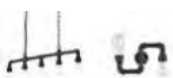

P. 340 P. 491

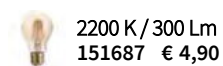

2200 K / 300 Lm
151687 € 4,90

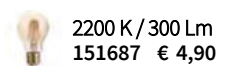

2200 K / 300 Lm
151687 € 4,90

Elisir

Montatura in metallo. Elementi decorativi a prisma in cristallo molato trasparente nella versione cromo, ambra in quella ottone.

LED Lampadine LED G9 3,2W 3000 K incluse. Cod. 209043

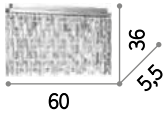

IP20

5,000 Kg / 0,0232 m³
G9 max 6x40W

200026 € 390
200095 € 400

3000 K / 300 Lm
209043 € 3,50



20095



20026

Martinez

Montatura in metallo cromato o dorato. Elementi decorativi con catene di ottagoni e barre in cristallo molato trasparente.

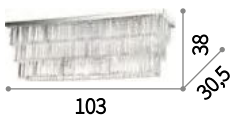

IP20

17,500 Kg / 0,0807 m³
E14 max 8 x 40W

166285 € 607
213569 € 638

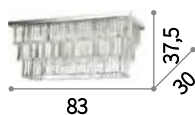

IP20

14,300 Kg / 0,0659 m³
E14 max 6 x 40W

166261 € 544

3000 K / 430 Lm
101224 € 2,90

3000 K / 430 Lm
101224 € 2,90



213569



166285

Carlton

Montatura in metallo cromato o dorato.
Elementi decorativi con catene di ottagoni
e barre in cristallo molato trasparente.

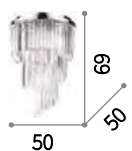

■ IP20

13,840 Kg / 0,1563 m³
E14 max 12 x 40W

168937 € 530
213507 € 562

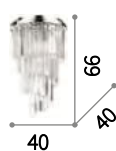

■ IP20

10,200 Kg / 0,1066 m³
E14 max 8 x 40W

168920 € 468

213507



3000 K / 430 Lm
101224 € 2,90

3000 K / 430 Lm
101224 € 2,90



P. 424

P. 509



168937

Elegant

Montatura in cromo. Canne in vetro
trasparente con sezione a stella.
Plafoniere con sfere centrali di cristallo
molato.

■ Lampadine alogene G9 28W 2700 K
includere.

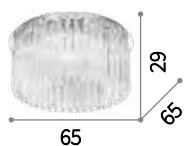

■ IP20

13,940 Kg / 0,1918 m³
G9 max 12 x 40W

019468 € 555

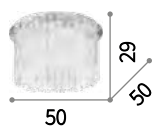

■ IP20

8,620 Kg / 0,1136 m³
G9 max 8 x 40W

019451 € 355



3000 K / 300 Lm
209043 € 3,50

3000 K / 300 Lm
209043 € 3,50



P. 425



100791

Pashà

Montatura in metallo. Diffusore composto da filari di perle in cristallo molato e fondo chiuso da vetro circolare sabbaiato.



100784

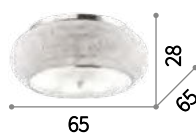

■ ⊕ IP20

13,000 Kg / 0,1809 m³
E14 max 14 x 40W

164991 € 857
165004 € 910



■ ⊕ IP20

8,800 Kg / 0,1040 m³
E14 max 10 x 40W

100746 € 738
100791 € 768

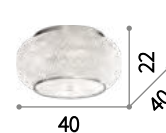

■ ⊕ IP20

6,200 Kg / 0,0529 m³
E14 max 6 x 40W

100784 € 562
100807 € 586



P. 428 P. 509

3000 K / 430 Lm
101200 € 2,90

3000 K / 430 Lm
101200 € 2,90

3000 K / 430 Lm
101200 € 2,90

Alba

Montatura in cromo. Vetri in canna di pirex sagomati a mano e componibili a piacere.

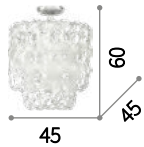

■ IP20

10,690 Kg / 0,1208 m³

E14 max 6 x 40W +
E27 max 1 x 60W

025490 € 518

3000 K / 430 Lm
101224 € 2,90



Dubai new

Montatura in metallo cromato o dorato. Elementi decorativi con perle, ottagoni e prismi in cristallo molato trasparente.

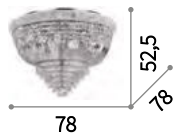

■ IP20

14,290 Kg / 0,4438 m³
E14 max 24 x 40W

243566 € 1.000 new
243498 € 1.050 new

3000 K / 430 Lm
101224 € 2,90

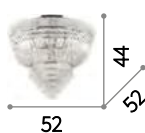

■ IP20

6,310 Kg / 0,2028 m³
E14 max 6 x 40W

207186 € 690
201016 € 720

3000 K / 430 Lm
101224 € 2,90

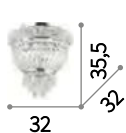

■ IP20

3,010 Kg / 0,0721 m³
E14 max 3 x 40W

207162 € 340
200996 € 365

3000 K / 430 Lm
101224 € 2,90



201016



207186

Caesar

Montatura in metallo con finitura in oro o cromo. Elementi decorativi in cristallo molato ottagonali con finali a puntale.

 Lampadine alogene G9 28W 2700 K incluse.

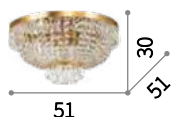

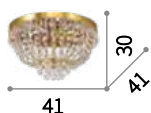

51



41



 IP20 

5,920 Kg / 0,1040 m³
G9 max 6 x 40W

093475  € 585
114682  € 615

 IP20 

3,820 Kg / 0,0632 m³
G9 max 5 x 40W

103792  € 510
114675  € 535

 3000 K / 300 Lm
209043 € 3,50

 3000 K / 300 Lm
209043 € 3,50



P. 432



P. 510



093475



114682

Magnolia new

Montatura in metallo con finitura oro. Elementi decorativi in cristallo molato trasparente. Nella parte superiore si alternano elementi trasparenti ed elementi fumè.

 Lampadine LED G9 3,2W 3000 K incluse. Cod. 209043

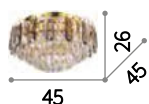

45

 IP20 

9,780 Kg / 0,1071 m³
G9 max 7 x 15W

241296  € 450 new

 3000 K / 300 Lm
209043 € 3,50





Bijoux

Montatura circolare e portalampane in metallo cromato. Elementi decorativi con catene di ottagoni e pendagli finali a sfera in cristallo molato.



Lampadine alogene G9 28W
2700 K incluse.

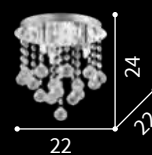
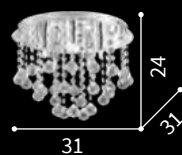

2,370 Kg / 0,0181 m³
G9 max 5 x 40W

089485 ■ € 162



1,810 Kg / 0,0125 m³
G9 max 4 x 40W

089478 ■ € 124



1,380 Kg / 0,0088 m³
G9 max 3 x 40W

089461 ■ € 100

3000 K / 300 Lm
209043 € 3,50

3000 K / 300 Lm
209043 € 3,50

3000 K / 300 Lm
209043 € 3,50

Harem

Montatura con decori in rilievo in metallo brunito e ottagoni in cristallo molato incastonati. Diffusori in vetro soffiato trasparente leggermente ambrato con pendaglio a nappa.

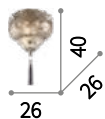

IP20

1,640 Kg / 0,0236 m³
E27 max 3 x 42W

139609 ■ € 200



3000 K / 860 Lm
119571 ■ € 6,50



P. 438



P. 512

Norma

Montatura in metallo con finitura in cromo o in brunito. Diffusore composto da lastre di vetro trasparente con bordo molato.

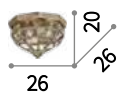

IP20

1,640 Kg / 0,0145 m³
E14 max 3 x 40W

094793 ■ € 140

004426 ■ € 140

094793



004426



3000 K / 430 Lm
101200 ■ € 2,90



P. 461



P. 515



Tirol

Montatura in metallo decorato a mano in color ruggine. Elementi floreali in vetro trasparente lavorato a pinza. Vetri trasparenti con sfumatura in giallo tenue, rifiniti artigianalmente.



■ ■ ⊕ IP20
 4,410 Kg / 0,0768 m³
 E14 max 6 x 40W
 024493 ■ € 202

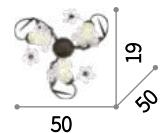

■ ■ ⊕ IP20
 2,660 Kg / 0,0494 m³
 E14 max 3 x 40W
 024509 ■ € 118



P. 454



3000 K / 430 Lm
 101200 € 2,90



3000 K / 430 Lm
 101200 € 2,90

Valentina

Montatura in metallo lavorato e dipinto a mano in bianco antico con riflessi oro e dettagli in rosa e verde. Vetri satinati.

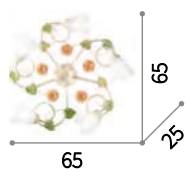

■ ■ ⊕ IP20
3,330 Kg / 0,1260 m³
E14 max 5 x 40W
220635 ■ € 237

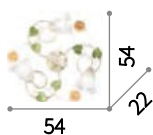

■ ■ ⊕ IP20
3,000 Kg / 0,0756 m³
E14 max 3 x 40W
220628 ■ € 150



3000 K / 360 Lm
101231 € 3,00

3000 K / 360 Lm
101231 € 3,00



Foglia

Montatura in metallo decorato a mano di colore nero. Diffusore in vetro centrifugato con decorazioni in rilievo dipinte a mano.

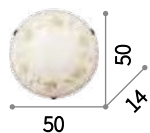

■ ■ ⊕ △ IP20
4,200 Kg / 0,0331 m³
E27 max 3 x 60W
013817 ■ € 97

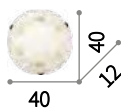

■ ■ ⊕ △ IP20
2,440 Kg / 0,0218 m³
E27 max 2 x 60W
013800 ■ € 55



3000 K / 430 Lm
101279 € 2,90

3000 K / 430 Lm
101279 € 2,90





Tintoretto

Montatura in metallo cromato.
Diffusore ed elementi decorativi in vetro
trasparente modellato a mano e rifinito
con graniglia.

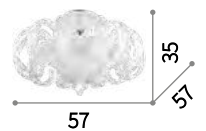

IP20

8,080 Kg / 0,1080 m³
E14 max 4 x 40W

103440 € 415



3000 K / 430 Lm
101224 € 2,90

008622



Shell

Diffusore di vetro trasparente lavorato in piastra e decorato all'interno con graniglia. Blocca vetro con dettaglio in metallo. Disponibile trasparente con dettaglio cromato o ambra con dettaglio ottonato.

140186

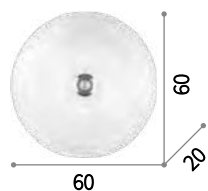

8,850 Kg / 0,0943 m³
E27 max 6 x 60W

008622 € 214
140193 € 214

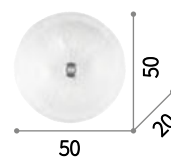

6,150 Kg / 0,0647 m³
E27 max 4 x 60W

008615 € 150
140186 € 150

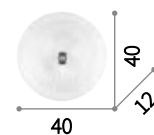

3,940 Kg / 0,0381 m³
E27 max 3 x 60W

008608 € 100
140179 € 100

3000 K / 430 Lm
101279 € 2,90

3000 K / 430 Lm
101279 € 2,90

3000 K / 430 Lm
101279 € 2,90

Winery

Corpo luce con portalampade incorporato interamente in ceramica smaltata bianca o nera.

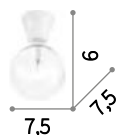

■ ■ □ IP20

0,290 Kg / 0,0004 m³
E27 max 1 x 60W

155227 ■ € 17
155142 ■ € 17

 3000 K / 860 Lm
101323 € 7,90



P. 498

155142



155227



Bob Mini

Montatura in metallo decorato effetto ruggine. Diffusori orientabili con raccordo di cavo in tessuto e gabbietta metallica nera.

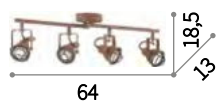

■ ■ ⊕ IP20

1,280 Kg / 0,0163 m³
GU10 max 4 x 25W

155494 ■ € 138

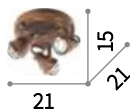

■ ■ ⊕ IP20

0,960 Kg / 0,0091 m³
GU10 max 3 x 25W

156415 ■ € 103

 3000 K / 560 Lm
101378 € 6,50

 3000 K / 560 Lm
101378 € 6,50



P. 499



Maracas

Montatura interamente in metallo rifinito in ottone satinato. Diffusori orientabili in vetro soffiato trasparente.

LED Lampadine LED G4 2W 3000 K incluse. Cod. 222257

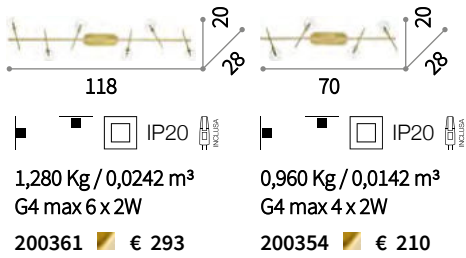

3000 K / 170 Lm
222257 € 3,90

3000 K / 170 Lm
222257 € 3,90



P. 488

Polka

Faretto da incasso fisso con montatura in metallo cromato. Elemento decorativo esterno in gesso con finitura in brunito, ottone o con vernice opaca bianca.

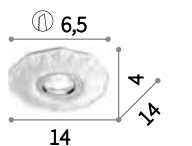

IP20

0,200 Kg / 0,0025 m³
GU10 max 1 x 50W

115597 € 12

115610 € 12

115580 € 12

3000 K / 400 Lm
108292 € 3,50



Classico

Lampade da parete



Equinoxe 488



Maracas 488



Kepler 489



Culto 489



Pan 490



Triumph 490



Plumber 491



Cantina 492



Sailor 493



Newton 493



Shower 494



Limbo 495



Retrò 496



Beverly 497



Astrid 500



Barber 501



Santa 502



Colossal 502



Negresco 503



Florian 503



Gioconda 504



Strauss 505

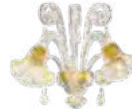

Ca' D'oro 506



Bon Bon 506



Blanche 507



Pegaso 507



Elisir 508



Martinez 508



Dubai 510



Caesar 510



Opera 511



Swan 511



Harem 512



Hammam 512



Chalet 513



Foglia 514



Corte 515



Norma 515



Carmen 516



Peter 516



Fiocco 517



Ape 517



Carrara 519



Igor 491



Frida 492



Winery 498



Bob Mini 499



Doge 504



Danieli 505



Carlton 509



Pashà 509



Giglio 513



Firenze 514



Stones 518



Scacchi 518



Beverly

Pag 497

Equinoxe

Montatura a bracci in metallo con finitura cromo o ottone antico. Diffusori in vetro soffiato trasparente.

LED Lampadine LED G4 2W 3000 K incluse. Cod. 222257

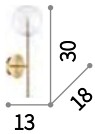

IP20

0,990 Kg / 0,0243 m³
G4 max 1x2W

200132 € 95
200149 € 105

3000 K / 170 Lm
222257 € 3,90



P. 325



Maracas

Montatura interamente in metallo rifinito in ottone satinato. Diffusori orientabili in vetro soffiato trasparente.

LED Lampadine LED G4 2W 3000 K incluse. Cod. 222257

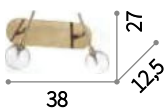

IP20

0,550 Kg / 0,0049 m³
G4 max 2x2W

200347 € 108

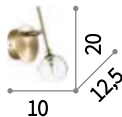

IP20

0,280 Kg / 0,0034 m³
G4 max 1x2W

200330 € 54

3000 K / 170 Lm
222257 € 3,90

3000 K / 170 Lm
222257 € 3,90



P. 485



Kepler

Montatura in metallo verniciato nero opaco. Diffusori in vetro soffiato trasparente ambrato.

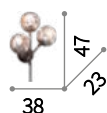

IP20

0,900 Kg / 0,0428 m³
E27 max 3 x 60W

187006 ■ € 190

3000 K / 430 Lm
101279 € 2,90



P. 326



Culto **new**

Montatura in metallo verniciato nero opaco e base con elemento in ottone satinato. Diffusori in vetro soffiato bianco, acidato.

LED Lampadine LED G9 3,2W 3000 K
includ. Cod. 209043

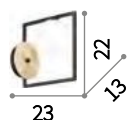

IP20

0,680 Kg / 0,0117 m³
G9 max 1x28W

225111 ■ € 85 **new**

3000 K / 300 Lm
209043 € 3,50



P. 331



P. 470



P. 522



P. 547



Pan

Montatura in metallo. Diffusori con elementi decorativi a tubi metallici di diverse misure.

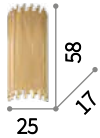

IP20

6,340 Kg / 0,0461 m³
E14 max 2 x 40W

208794 € 313



3000 K / 430 Lm
101200 € 2,90



P. 335

Triumph ^{new}

Montatura interamente in metallo con finitura nero o ottone invecchiato. Modelli AP con cavo in tessuto con interruttore e spina.



Lampada con interruttore integrato.

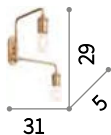

IP20

0,710 Kg / 0,0067 m³
E27 max 2 x 60W

160245 € 140
242385 € 130 *new*

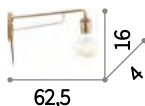

IP20

0,490 Kg / 0,0083 m³
E27 max 1 x 60W

160214 € 85
242392 € 80 *new*



242385



160214



2200 K / 300 Lm
151687 € 4,90



2200 K / 300 Lm
151687 € 4,90



P. 336

P. 470

Plumber

Montatura con elementi idraulici in metallo. Finiture: nero opaco o nero antichizzato.

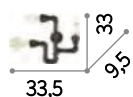

IP20

2,200 Kg / 0,0154 m³
E27 max 3 x 42W

175317 ■ € 150
142517 ■ € 150

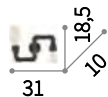

IP20

1,420 Kg / 0,0121 m³
E27 max 2 x 42W

136691 ■ € 104

2200 K / 300 Lm
151687 € 4,90

2200 K / 300 Lm
151687 € 4,90

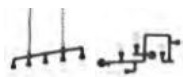

P. 340 P. 472



142517



175317

Igor

Montatura in metallo con finitura opaca bianca o nera. Diffusore con lastre di vetro trasparente.

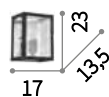

IP20

1,590 Kg / 0,0136 m³
E27 max 1 x 60W

149684 ■ € 68
092836 ■ € 68

2200 K / 300 Lm
151694 € 5,90



P. 338



149684



092836

Frida

Montatura in metallo con finiture brunito e rame. Cavo in tessuto nero.



IP20

0,430 Kg / 0,0092 m³
E27 max 1 x 60W

163338 € 37
163321 € 37

2200 K / 300 Lm
151717 € 6,90



163338



163321



Cantina

Montatura, diffusore e copriportalampada in metallo disponibile con finitura brunito o rame.

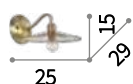

IP20

0,520 Kg / 0,0184 m³
E14 max 1 x 40W

112695 € 60
112626 € 60

3000 K / 430 Lm
101200 € 2,90



P. 356



112626



200095

Sailor

Corpo luce a cupola in metallo con finitura brunito e rame e smaltato bianco all'interno. Diffusore in vetro soffiato con effetto rustico.

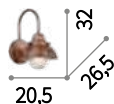

IP20

1,250 Kg / 0,0250 m³
E27 max 1 x 60W

025292 € 105
025261 € 105

3000 K / 860 Lm
119571 € 6,50



P. 372



025261



025292

Newton

Montatura e diffusore in metallo. Disponibile con finitura in nickel satinato, brunito o con vernice nera opaca. Braccio regolabile. Diffusore orientabile smaltato bianco all'interno.



IP20

0,600 Kg / 0,0093 m³
E27 max 1 x 60W

016399 € 50
027876 € 50
027852 € 38

3000 K / 720 Lm
123899 € 6,90



P. 366



P. 523



P. 550



027876



016399



027852



Shower

Montatura in metallo verniciato opaco bianco o nero. Elemento snodato in cromo. Diffusore orientabile. Cavo in tessuto con interruttore e spina.

ON
OFF Lampada con interruttore integrato.

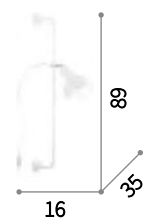

■ □ IP20

0,760 Kg / 0,0391 m³
E27 max 1x60W

179667 ■ € 104
179643 ■ € 104

3000 K / 720 Lm
123899 € 6,90



180212

Limbo

Diffusore orientabile in metallo verniciato opaco bianco o nero. Supporto a morsetto in metallo. Cavo con interruttore e spina.

ON
OFF Lampada con interruttore integrato.



180229

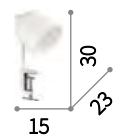

IP20

0,600 Kg / 0,0107 m³
E27 max 1 x 60W

180212 € 55
180229 € 55

3000 K / 720 Lm
123899 € 6,90



Retrò

Montatura e diffusore interamente in metallo con finitura brunito. Diffusore orientabile.

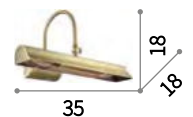

IP20

0,790 Kg / 0,0152 m³
E14 max 2 x 28W

144917 € 87

3000 K / 430 Lm
101224 € 2,90



Beverly

Montatura in metallo con finitura in ottone satinato o in cromo. Braccio snodato regolabile. Paralume in lamina di PVC rivestito in tessuto.

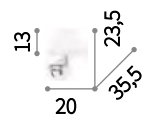

■ IP20

0,460 Kg / 0,0227 m³
E14 max 1x40W

126784 € 50
140247 € 56

3000 K / 360 Lm
101217 € 3,00



P. 551



180304

Winery

Corpo luce con portalampade incorporato interamente in ceramica smaltata bianca o nera. Modello AP con assetto inclinato verso il basso.



180298

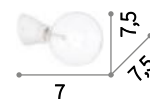

■ ■ □ IP20

0,250 Kg / 0,0004 m³
E27 max 1 x 60W

180298 ■ € 19
180304 ■ € 19



P. 484



3000 K / 860 Lm
101323 € 7,90





Bob Mini

Montatura in metallo decorato effetto ruggine. Diffusori orientabili con raccordo di cavo in tessuto e gabbietta metallica nera.

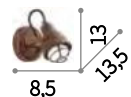

 IP20
 0,630 Kg / 0,0060 m³
 GU10 max 2 x 25W
 156408 ■ € 75



 IP20
 0,290 Kg / 0,0025 m³
 GU10 max 1 x 25W
 156392 ■ € 42



P. 484

 3000 K / 560 Lm
 101378 € 6,50

 3000 K / 560 Lm
 101378 € 6,50



139951

Astrid

Montatura in metallo con finitura in brunito o vernice nera opaca. Diffusore in vetro trasparente.



140001

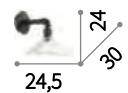

IP20

1,530 Kg / 0,0236 m³
E27 max 1 x 60W

140001 € 65
139951 € 65

3000 K / 430 Lm
101279 € 2,90



159997

Barber

Base, snodo e copri portalampane interamente in metallo. Corpo luce inclinabile. Disponibile nella versione brunito o nickel.

LED Lampadine LED GU10 5W 3000 K incluse. Cod. 108292



160016

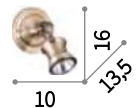

IP20 

0,230 Kg / 0,0025 m³
GU10 max 1 x 28W

160016 € 53
159997 € 53

 3000 K / 400 Lm
108292 € 3,50

Santa

Lampadario in vetro trasparente soffiato e lavorato a mano. Dettagli in metallo cromato. Versione oro disponibile con graniglia sul vetro.

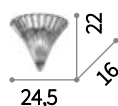
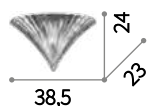

■ IP20

■ IP20

2,900 Kg / 0,0380 m³
E14 max 1 x 40W

1,200 Kg / 0,0184 m³
E14 max 1 x 40W

087368 € 175
087375 € 175

013060 € 75
013046 € 75

3000 K / 430 Lm
101224 € 2,90

3000 K / 430 Lm
101224 € 2,90



P. 380

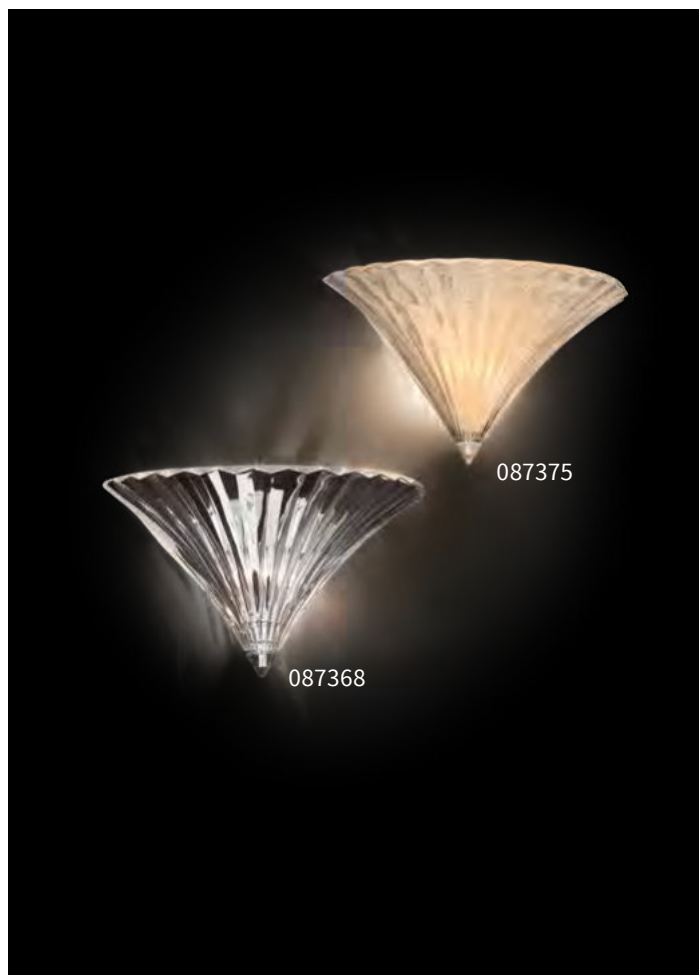

Colossal

Montatura e dettagli in metallo cromato. Bracci in vetro soffiato trasparente o con interno di colore grigio o bianco avorio.

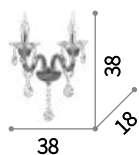

■ IP20

1,870 Kg / 0,0159 m³
E14 max 2 x 40W

114200 € 110
081533 € 125
081496 € 125

3000 K / 430 Lm
101224 € 2,90



P. 378



081496



114200

081533

Negresco

Montatura in metallo con finitura in cromo o dorata. Bracci in vetro soffiato trasparente con interno dorato nella versione oro. Centrale composto da blocchi di cristallo molato. Elementi decorativi in vetro trasparente e cristallo molato.

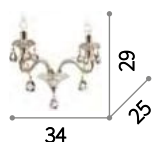

IP20

2,320 Kg / 0,0321 m³
E14 max 2 x 40W

141046 € 120
087757 € 128

3000 K / 430 Lm
101248 € 2,90



P. 381



141046



087757

Florian

Montatura in metallo con elementi decorativi in vetro. Pendagli con ottagoni e gocce finali in cristallo molato. Disponibile nelle versioni con vetro trasparente e metallo dorato o cromato.

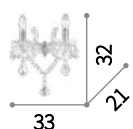

IP20

1,430 Kg / 0,0189 m³
E14 max 2 x 40W

035642 € 117
035659 € 120

3000 K / 430 Lm
101224 € 2,90



P. 388



P. 554

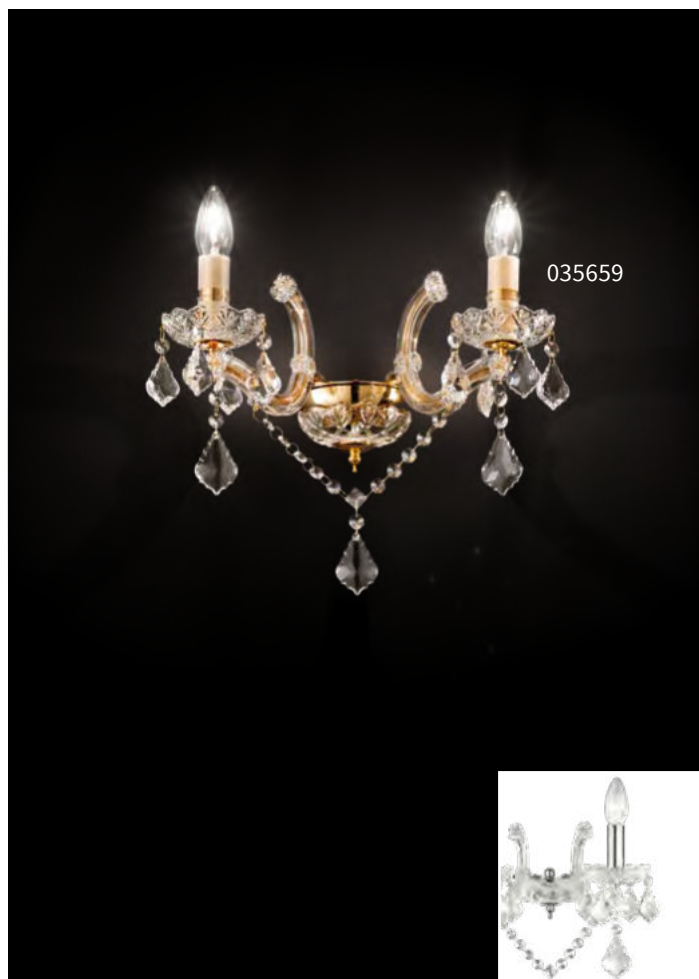

035659



035642

Gioconda

Corpo luce in fusione di metallo con finitura oro o argento antico. Pendagli ottagonali e tondi in cristallo molato.

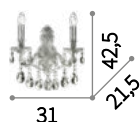

IP20

1,310 Kg / 0,0111 m³
E14 max 2 x 40W

044910 € 158
060491 € 164

3000 K / 430 Lm
101224 € 2,90



P. 392



060491



060491

Doge

Lampadario in vetro, trasparente o bianco, soffiato e lavorato a mano. Montatura e dettagli in metallo rifinito in cromo.



IP20

1,260 Kg / 0,0568 m³
E14 max 2 x 40W

044392 € 116
113654 € 136

3000 K / 430 Lm
101224 € 2,90



P. 397



113654



035642

Danieli

Montatura in metallo cromato o dorato.
Elementi decorativi in vetro soffiato
trasparente o ambrato.

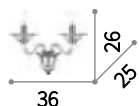

IP20

1,480 Kg / 0,0261 m³
E14 max 2 x 40W

159966 € 110
159935 € 120



159966

3000 K / 430 Lm
101200 € 2,90



P. 398



159935

Strauss

Montatura e dettagli in metallo con
finitura oro rosa. Bracci in vetro soffiato
trasparente. Elementi decorativi in
cristallo ambrato.

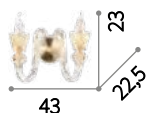

IP20

2,080 Kg / 0,0431 m³
E14 max 2 x 40W

140599 € 110



3000 K / 430 Lm
101248 € 2,90



P. 402

Ca' D'oro

Lampadario in vetro trasparente soffiato e lavorato a mano, rifinito con ambra in pasta di vetro. Coppa interna in metallo ottonato.

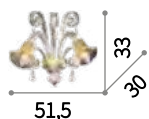

IP20

2,220 Kg / 0,0372 m³
E14 max 2 x 40W

020983 € 260

3000 K / 430 Lm
101200 € 2,90



P. 403



Bon Bon

Montatura con bracci in fusione di metallo rifinito con vernice opaca bianca. Bobeche in vetro soffiato.



IP20

1,670 Kg / 0,0343 m³
E14 max 2 x 40W

093987 € 140

3000 K / 360 Lm
101217 € 3,00



P. 408



Blanche

Montatura in metallo rifinito con smalto satinato bianco o nero. Paralumi in lamina di PVC rivestita di tessuto bianco o nero.

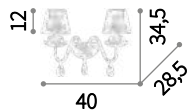

IP20

1,480 Kg / 0,0383 m³
E14 max 2 x 40W

035598 € 100
111889 € 100

3000 K / 360 Lm
101231 € 3,00



P. 412



035598



111889

Pegaso

Montatura in metallo cromato oppure ottone satinato. Corpo centrale, bobeches e pendagli in cristallo molato. Paralumi in organza.

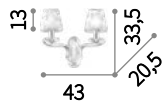

IP20

1,600 Kg / 0,0302 m³
E14 max 2 x 40W

059211 € 120
197708 € 125

3000 K / 360 Lm
101231 € 3,00



P. 414



P. 537



P. 556



059211



197708

Elisir

Montatura in metallo. Elementi decorativi a prisma in cristallo molato trasparente nella versione cromo, ambra in quella ottone.

LED Lampadine LED G9 3,2W 3000 K incluse. Cod. 209043

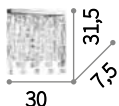

IP20

1,670 Kg / 0,0093 m³
G9 max 3 x 40W

199986 € 166
200057 € 170

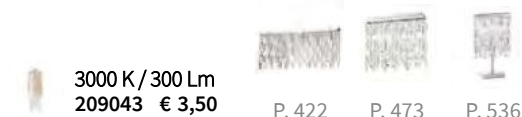

3000 K / 300 Lm
209043 € 3,50

P. 422

P. 473

P. 536

200057



199986

Martinez

Montatura in metallo cromato o dorato. Elementi decorativi con catene di ottagoni e barre in cristallo molato trasparente.

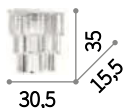

IP20

3,320 Kg / 0,0145 m³
E14 max 3 x 40W

166254 € 168
213545 € 178



3000 K / 430 Lm
101224 € 2,90

P. 423

P. 473

213545



166254

Carlton

Montatura in metallo cromato o dorato.
Elementi decorativi con catene di ottagoni
e barre in cristallo molato trasparente.

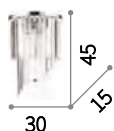

IP20

2,570 Kg / 0,0154 m³
E14 max 3 x 40W

168913 € 128
213491 € 137

3000 K / 430 Lm
101224 € 2,90



P. 424 P. 474

213491



168913

Pashà

Montatura in metallo. Diffusore composto
da filari di perle in cristallo molato e fondo
chiuso da vetro circolare sabbato.

Lampadine alogene G9 28W 2700 K
includere.

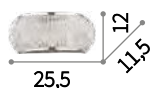

IP20

1,110 Kg / 0,0076 m³
G9 max 3 x 40W

082264 € 150
082288 € 157

3000 K / 300 Lm
209043 € 3,50



P. 428 P. 475



082288



082264

Dubai

Montatura in metallo cromato o dorato.
Elementi decorativi con perle, ottagononi e
prismi in cristallo molato trasparente.

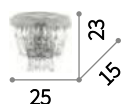

IP20

1,190 Kg / 0,0259 m³
E14 max 2 x 40W

207155 € 156
201023 € 165

3000 K / 430 Lm
101224 € 2,90



201023



207155

Caesar

Montatura in metallo con finitura in oro
o cromo. Elementi decorativi in cristallo
molato ottagonali con finali a puntale.

Lampadine alogene G9 28W 2700 K
includere.

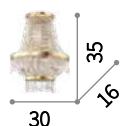

IP20

2,290 Kg / 0,0357 m³
G9 max 3 x 40W

137698 € 285
137704 € 295

3000 K / 300 Lm
209043 € 3,50



137698



137704

Opera

Montatura in cromo. Paralume in lamina di PVC con riflessi metallizzati e rivestita da fili. Pendagli in cristallo molato.

LED Sorgente luminosa LED 3000 K, 15.000 h di durata.

ON/OFF Lampada con interruttore integrato.



IP20

1,550 Kg / 0,0220 m³

E14 max 2 x 40W +
LED 1W / 45 Lm

068268 € 125

 3000 K / 360 Lm
101217 € 3,00



P. 434



P. 536



P. 554

Swan

Montatura in cromo. Corpo luce in vetro soffiato e lavorato a mano. Elementi decorativi in cristallo molato. Paralume in tessuto d'organza plissettato.



IP20

2,468 Kg / 0,0517 m³

E14 max 2 x 40W

035864 € 160

 3000 K / 360 Lm
101217 € 3,00



P. 436



Harem

Montatura con decori in rilievo in metallo brunito e ottagoni in cristallo molato incastonati. Diffusori in vetro soffiato trasparente leggermente ambrato con pendaglio a nappa.



IP20

0,900 Kg / 0,0273 m³

E27 max 1 x 60W

115962 ■ € 140



3000 K / 860 Lm
119571 ■ € 6,50



P. 438



P. 479

Hammam

Montatura in metallo rifinito argento. Diffusori in vetro soffiato trasparente. Pendagli a nappa.

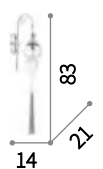

IP20

0,750 Kg / 0,0338 m³

E14 max 1 x 40W

139593 ■ € 105



3000 K / 430 Lm
101200 ■ € 2,90



P. 439

Chalet

Montatura con struttura portante in metallo. Elementi decorativi in resina lavorata artigianalmente e dipinta a mano come fedele riproduzione di corna e legno intagliato.

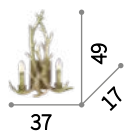

IP20

1,770 Kg / 0,0759 m³
E14 max 2 x 40W

115511 ■ € 170



3000 K / 430 Lm
101224 € 2,90



P. 448



P. 530



Giglio

Montatura con struttura portante in metallo. Corpo luce in resina modellata con tecniche artigianali che riproducono fedelmente il legno intagliato. Decorato e antichizzato a mano con foglia d'oro.

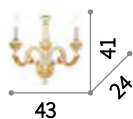

IP20

2,400 Kg / 0,0268 m³
E14 max 2 x 40W

075280 ■ € 154



3000 K / 430 Lm
101248 € 2,90



P. 451



Firenze

Corpo luce in resina. Bracci e foglie in metallo modellato artigianalmente. Decorato a mano con foglia d'oro e antichizzato.

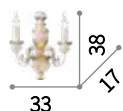

IP20

2,050 Kg / 0,0405 m³
E14 max 2 x 40W

012902 € 104
020846 € 104



012902

3000 K / 430 Lm
101248 € 2,90



P. 451



P. 531



P. 555



020846

Foglia

Montatura in metallo decorato a mano di colore nero. Diffusore in vetro centrifugato con decorazioni in rilievo dipinte a mano.

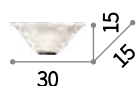

IP20

0,620 Kg / 0,0072 m³
E27 max 1 x 60W

013787 € 25



3000 K / 430 Lm
101279 € 2,90



P. 455



P. 481

Corte

Montatura completamente in metallo modellato con lavorazione artigianale. Finitura dipinta a mano con effetto antichizzato. Disponibile nella versione bianca o ruggine.

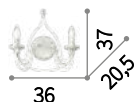

■ □ IP20

1,060 Kg / 0,0329 m³
E14 max 2 x 40W

028460 ■ € 64
057200 ■ € 64



3000 K / 430 Lm
101224 € 2,90



P. 457

Norma

Montatura in metallo con finitura in cromo o in brunito. Diffusore composto da lastre di vetro trasparente con bordo molato.

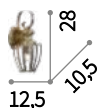

■ ⊕ ▲ IP20

1,590 Kg / 0,0215 m³
E27 max 1 x 60W

100425 ■ € 72
004419 ■ € 72



3000 K / 430 Lm
101279 € 2,90



P. 461



P. 479

Carmen

Corpo luce in resina modellata con tecniche artigianali. Decorato e antichizzato a mano con foglia d'oro e vernice argentata.

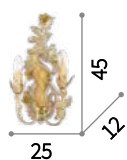

IP20

1,080 Kg / 0,0318 m³
E14 max 2 x 40W

093703 € 170

3000 K / 430 Lm
101248 € 2,90



Peter

Montatura in resina lavorata artigianalmente come fedele riproduzione del legno intagliato. Paralume in lamina di PVC rivestito in tessuto canvas.

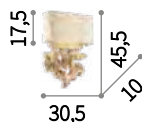

IP20

4,160 Kg / 0,0371 m³
E14 max 2 x 40W

075211 € 195

3000 K / 430 Lm
101200 € 2,90



Fiocco

Diffusore di vetro trasparente lavorato in piastra con graniglia. Decoro centrale color ambra. Viti fermavetro in ottone satinato.

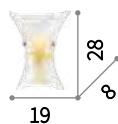
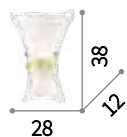

■ IP20

1,800 Kg / 0,0265 m³
E27 max 1 x 60W

014630 € 65

■ IP20

1,080 Kg / 0,0112 m³
E14 max 1 x 40W

014623 € 45

3000 K / 430 Lm
101279 € 2,90

3000 K / 430 Lm
101200 € 2,90



Ape

Diffusore di vetro trasparente lavorato in piastra, decorato con graniglia bianca nella zona centrale e ambra nelle parti laterali. Viti fermavetro in cromo.

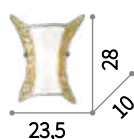
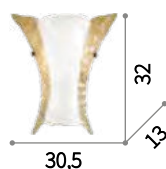

■ IP20

1,820 Kg / 0,0289 m³
E27 max 1 x 60W

002903 € 62

■ IP20

1,180 Kg / 0,0133 m³
E14 max 1 x 40W

002897 € 48

3000 K / 430 Lm
101279 € 2,90

3000 K / 430 Lm
101200 € 2,90

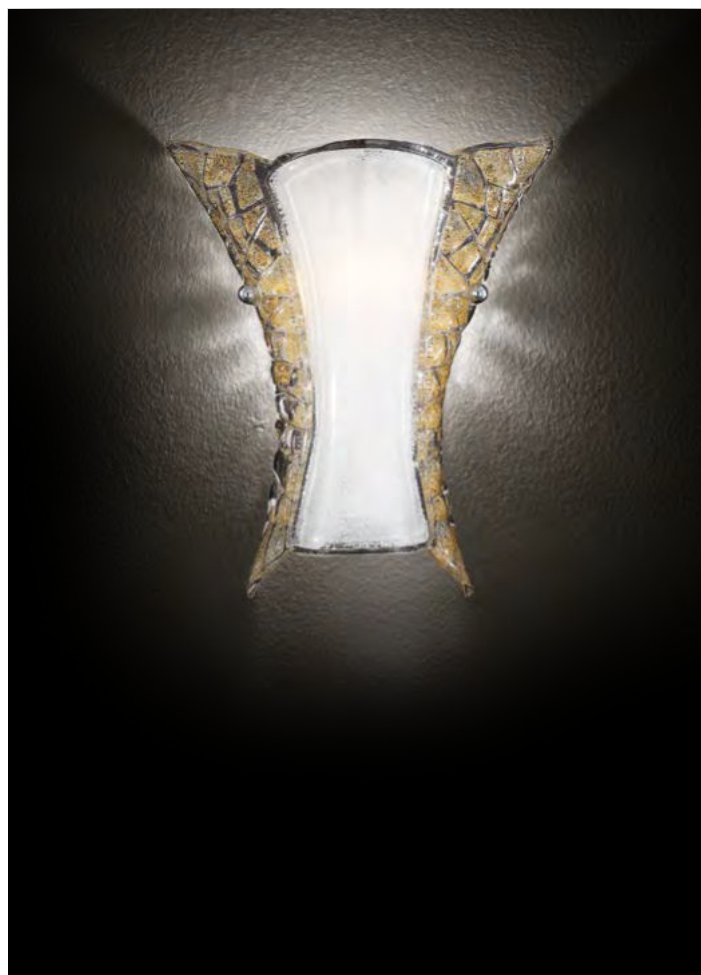

Stones

Montatura in metallo smaltato bianco.
Diffusore interamente realizzato con
elementi in alabastro naturale, aperto
sulle estremità superiore e inferiore.



■ IP20

4,110 Kg / 0,0207 m³
E27 max 2 x 60W

015132 ■ € 110

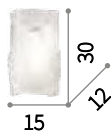

■ IP20

2,660 Kg / 0,0141 m³
E27 max 1 x 60W

015125 ■ € 67

3000 K / 360 Lm
101286 € 3,00

3000 K / 360 Lm
101286 € 3,00



Scacchi

Montatura in metallo smaltato bianco.
Diffusore interamente realizzato con
elementi in alabastro naturale, aperto
sulle estremità superiore e inferiore.



■ IP20

3,010 Kg / 0,0167 m³
E27 max 2 x 60W

015118 ■ € 95

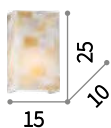

■ IP20

5,900 Kg / 0,0111 m³
E27 max 1 x 60W

015101 ■ € 60

3000 K / 360 Lm
101286 € 3,00

3000 K / 360 Lm
101286 € 3,00







Carrara

Diffusore interamente realizzato con elementi in alabastro, aperto sulle estremità superiore e inferiore.

LED Lampadine LED G9 3,2W 3000 K incluse. Cod. 209043



 IP20 
 1,500 Kg / 0,0081 m³
 G9 max 2 x 40W
 018775 € 78

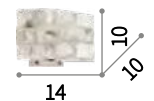

 IP20 
 1,200 Kg / 0,0049 m³
 G9 max 1 x 40W
 000619 € 60

 3000 K / 300 Lm
 209043 € 3,50

 3000 K / 300 Lm
 209043 € 3,50

Classico

Lampade da tavolo



Bin 522



Culto 522



Newton 523



Truman 524



Mermaid 525



Amsterdam 526



Lawyer 527



Kronplatz 530



Chalet 530



Provence 531



Firenze 531



Driftwood 532



Snell 533



Dolomiti 534



Opera 536



Pegaso 537



Step 537



Queen 538



Le Roy 538



Paris 539



Magic 540



Duchessa 543



Alfiere 528



Eternity 529



Boulder 535



Elisir 536



Kate 541



Voga 542



Boulder

Pag 535

Bin

Montatura e diffusore in metallo rifinito con vernice opaca nera. Braccio snodato regolabile. Diffusore orientabile.

ON
OFF Lampada con interruttore integrato.

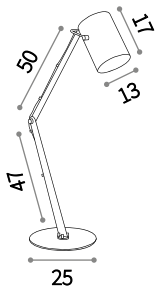

IP20

3,570 Kg / 0,0528 m³
E27 max 1x42W
144863 ■ € 220



P. 546



3000 K / 860 Lm
119571 € 6,50

Culto new

Montatura in metallo verniciato nero opaco e base con elemento in ottone satinato. Diffusori in vetro soffiato bianco, acidato.

LED Lampadine LED G9 3,2W 3000 K include. Cod. 209043

ON
OFF Lampada con interruttore integrato.



IP20
1,350 Kg / 0,0113 m³
G9 max 1x28W

248400 ■ € 95 new



3000 K / 300 Lm
209043 € 3,50



P. 331



P. 470



P. 489



P. 547



003535

Newton

Montatura e diffusore in metallo.
Disponibile con finitura in nickel satinato
o con vernice nera opaca. Braccio
regolabile. Diffusore orientabile smaltato
bianco all'interno.

ON
OFF Lampada con interruttore integrato.



012209

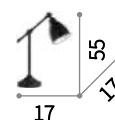

IP20

2,300 Kg / 0,0104 m³
E27 max 1x60W

012209 € 83
003535 € 57

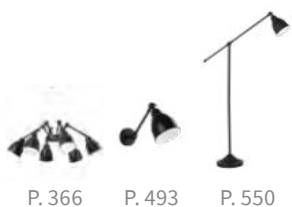

P. 366

P. 493

P. 550

3000 K / 720 Lm
123899 € 6,90



Truman

Montatura e diffusore in metallo rifinito con vernice opaca bianca, grigia o nera. Braccio snodato con raccordi in metallo brunito. Diffusore smaltato bianco all'interno. Cavo rivestito in tessuto vintage bianco e nero.

ON
OFF Lampada con interruttore integrato.

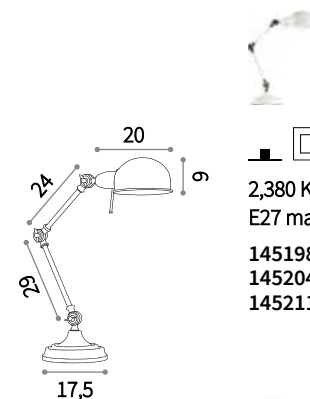

IP20
2,380 Kg / 0,0283 m³
E27 max 1x60W
145198 € 72
145204 € 72
145211 € 72

3000 K / 430 Lm
101279 € 2,90



Mermaid

Montatura interamente in metallo con finitura cromo o bianco antichizzato. Diffusori in vetro trasparente.

ON
OFF Lampada con interruttore integrato.

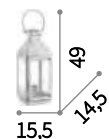

IP20

2,670 Kg / 0,0601 m³
E27 max 1 x 60W

166766 € 158
166667 € 190

IP20

1,630 Kg / 0,0350 m³
E27 max 1 x 60W

166742 € 113
166650 € 143

3000 K / 860 Lm
119571 € 6,50

3000 K / 860 Lm
119571 € 6,50



Amsterdam

Montatura in metallo rifinito brunito.
Braccio regolabile in altezza. Diffusore orientabile.

ON
OFF Lampada con interruttore integrato.



P. 550

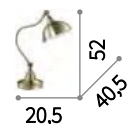

IP20

2,180 Kg / 0,0784 m³
E27 max 1 x 60W

131733 € 159

3000 K / 860 Lm
119571 € 6,50



013657

Lawyer

Montatura in metallo con finitura disponibile in ottone, in cromo o in brunito. Diffusore in vetro soffiato e incamiciato.

ON
OFF Lampada con interruttore integrato.



045047

045030



IP20

1,850 Kg / 0,0373 m³
E27 max 1x60W

045047 € 83
013657 € 83
045030 € 83

3000 K / 860 Lm
119571 € 6,50



Alfiere

Corpo luce in metallo cromato. Paralume in lamina di PVC in colore cromo semitrasparente.

ON
OFF Lampada con interruttore integrato.

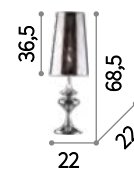

IP20
1,230 Kg / 0,0276 m³
E27 max 1 x 60W
032436 € 95



IP20
0,920 Kg / 0,0139 m³
E27 max 1 x 60W
032467 € 75

 3000 K / 860 Lm
119571 € 6,50

 3000 K / 860 Lm
119571 € 6,50



Eternity

Base in fusione di metallo. Finitura cromo con paralume di organza plissettata e riflessi metallizzati.

ON
OFF Lampada con interruttore integrato.

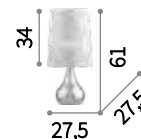

■ IP20
1,720 Kg / 0,0378 m³
E27 max 1 x 60W
036007 ■ € 96

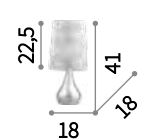

■ IP20
0,770 Kg / 0,0128 m³
E14 max 1 x 40W
035987 ■ € 56

● 3000 K / 720 Lm
123899 € 6,90

● 3000 K / 360 Lm
101217 € 3,00

Kronplatz

Montatura in metallo cromato. Paralume in lamina di PVC rivestita con tessuto canvas.

 Lampadine alogene G9 28W 2700 K incluse.

 Lampada con interruttore integrato.

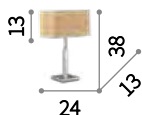

 IP20 

0,830 Kg / 0,0135 m³

G9 max 1x40W

110875 € 70

 3000 K / 300 Lm
209043 € 3,50



Chalet

Montatura con struttura portante in metallo. Elementi decorativi in resina lavorata artigianalmente e dipinta a mano come fedele riproduzione di corna e legno intagliato.

 Lampada con interruttore integrato.

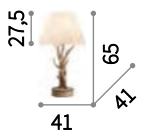

 IP20

3,500 Kg / 0,1650 m³

E27 max 1x60W

128207 € 220

 3000 K / 860 Lm
119571 € 6,50



Provence

Corpo luce in legno tornito e bracci in metallo. Finitura con vernice opaca. Paralumi in lamina di PVC rivestita in tessuto a trama grossa.

ON
OFF Lampada con interruttore integrato.

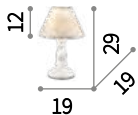

IP20

0,400 Kg / 0,0221 m³
E14 max 1 x 40W

003283 € 60



3000 K / 430 Lm
101200 € 2,90



Firenze

Corpo luce in resina. Bracci e foglie in metallo modellato artigianalmente. Decorato a mano con foglia d'oro e antichizzato.

ON
OFF Lampada con interruttore integrato.

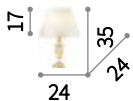

IP20

1,220 Kg / 0,0216 m³
E14 max 1 x 40W

012889 € 94
020853 € 94



012889

3000 K / 430 Lm
101200 € 2,90



020853



Driftwood

Montatura in metallo. Elementi decorativi con rami di legno naturale. Diffusore in lamina di pvc rivestito con tessuto canvas.

ON **OFF** Lampada con interruttore integrato.

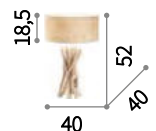

IP20

2,450 Kg / 0,0709 m³

E27 max 1 x 60W

129570 € 200



P. 449

P. 553

2200 K / 300 Lm
151687 € 4,90



Snell

Base in legno naturale. Corpo luce formato da rami veri. Paralume in lamina di pvc rivestita di tessuto.

ON / **OFF** Lampada con interruttore integrato.

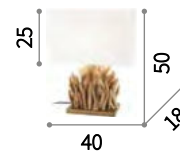

IP20
1,400 Kg / 0,0733 m³
E27 max 1 x 60W
201399 € 260

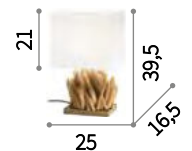

IP20
1,290 Kg / 0,0389 m³
E27 max 1 x 60W
201382 € 215

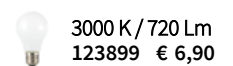
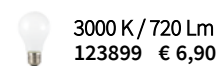



Dolomiti

Corpo luce con elementi in ceramica smaltati. Dettagli metallici in nickel satinato. Paralume in lamina di PVC rivestita di tessuto tipo lino di colore beige.



Lampada con interruttore integrato.



IP20
4,620 Kg / 0,1108 m³
E27 max 1 x 60W
034942 € 134

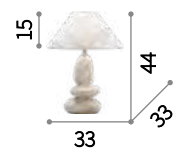

IP20
2,300 Kg / 0,0643 m³
E27 max 1 x 60W
034935 € 87

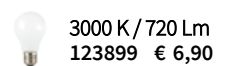
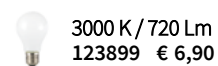



Boulder **new**

Base in cemento lavorato artigianalmente.
Paralume in pvc rivestito con tessuto.
Cavo in tessuto con interruttore.

ON
OFF Lampada con interruttore integrato.



IP20

4,790 Kg / 0,0833 m³
E27 max 1 x 60W

238128 ■ € 115 **new**

 3000 K / 860 Lm
119571 € 6,50

Elisir

Montatura in metallo. Elementi decorativi a prisma in cristallo molato trasparente nella versione cromo, ambra in quella ottone.

LED Lampadine LED G9 3,2W 3000 K incluse. Cod. 209043

ON OFF Lampada con interruttore integrato.

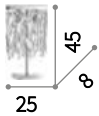

2,960 Kg / 0,0175 m³
G9 max 2x40W

200033 € 225
200101 € 235



3000 K / 300 Lm
209043 € 3,50

P. 422

P. 473

P. 508



200033



200101

Opera

Montatura in cromo. Paralume in lamina di PVC con riflessi metallizzati e rivestita da fili. Pendagli in cristallo molato.

ON OFF Lampada con interruttore integrato.



1,750 Kg / 0,0392 m³
E27 max 1 x 60W

068305 € 110



P. 434

P. 511

P. 554

3000 K / 720 Lm
123899 € 6,90



Pegaso

Montatura in metallo cromato oppure ottone satinato. Corpo centrale, bobeches e pendagli in cristallo molato. Paralumi in organza.

ON
OFF Lampada con interruttore integrato.

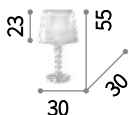

IP20
2,000 Kg / 0,0705 m³
E27 max 1 x 60W
059259 € 165

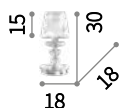

IP20
1,450 Kg / 0,0117 m³
E14 max 1 x 40W
059266 € 77
197753 € 86

3000 K / 720 Lm
123899 € 6,90

3000 K / 360 Lm
101217 € 3,00



P. 414

P. 507



P. 556



059259



197753

Step

Corpo luce in metallo cromato decorato con sfere di vetro. Paralume in lamina di PVC rivestita di tessuto bianco con fantasia floreale in rilievo.

ON
OFF Lampada con interruttore integrato.



IP20
2,870 Kg / 0,0843 m³
E27 max 1 x 60W
026862 € 157



IP20
1,550 Kg / 0,0442 m³
E27 max 1 x 60W
026855 € 86

3000 K / 720 Lm
123899 € 6,90

3000 K / 720 Lm
123899 € 6,90



P. 557



Queen

Montatura in metallo dorato con elementi decorativi e base in cristallo molato. Paralume in lamina di PVC, rivestita in tessuto con decorazione trapuntata e brillantini dorati.

ON
OFF Lampada con interruttore integrato.

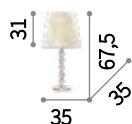

IP20
2,300 Kg / 0,0886 m³
E27 max 1 x 60W
077758 € 165



IP20
1,360 Kg / 0,0460 m³
E27 max 1 x 60W
077741 € 115

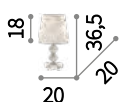

IP20
0,900 Kg / 0,0137 m³
E27 max 1 x 60W
077734 € 90



3000 K / 860 Lm
119571 € 6,50

3000 K / 860 Lm
119571 € 6,50

3000 K / 860 Lm
119571 € 6,50



P. 437

P. 558

Le Roy

Montatura e base in metallo cromato con elementi decorativi in cristallo molato. Paralume in lamina di PVC, rivestita in tessuto con decorazione trapuntata e brillantini argentati.

ON
OFF Lampada con interruttore integrato.

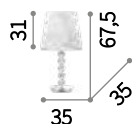

IP20
2,300 Kg / 0,0919 m³
E27 max 1 x 60W
073408 € 150

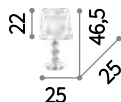

IP20
1,360 Kg / 0,0456 m³
E27 max 1 x 60W
073422 € 100

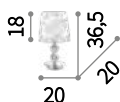

IP20
0,900 Kg / 0,0234 m³
E27 max 1 x 60W
073439 € 80



3000 K / 860 Lm
119571 € 6,50

3000 K / 860 Lm
119571 € 6,50

3000 K / 860 Lm
119571 € 6,50



P. 558





Paris

Montatura in nickel satinato. Bobeches in cristallo molato. Paralume in lamina di PVC rivestita da fili argentati.

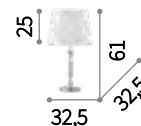

 Lampada con interruttore integrato.

 Lampada con dimmer.

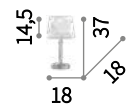

 
 1,900 Kg / 0,0613 m³
 E27 max 1 x 60W
 014975 ■ € 110



 
 0,860 Kg / 0,0143 m³
 E14 max 1 x 40W
 015965 ■ € 68

 3000 K / 860 Lm
 119571 ■ € 6,50

 3000 K / 430 Lm
 101200 ■ € 2,90

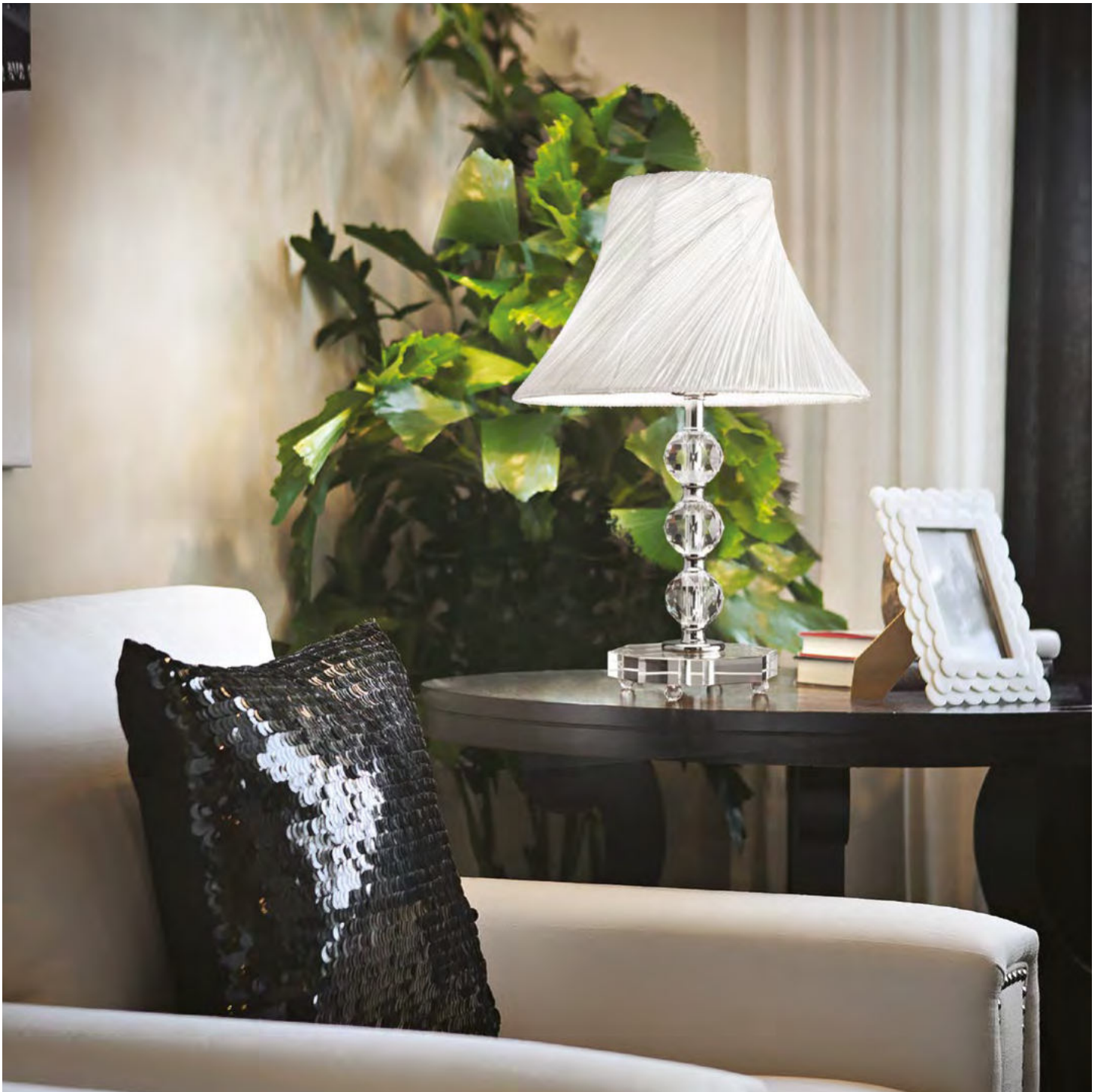

Magic

Base e corpo luce con elementi in cristallo molato e dettagli metallici con finitura in cromo. Paralume in tessuto bianco plissettato.

ON
OFF Lampada con interruttore integrato.

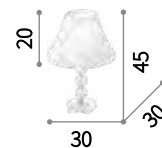

IP20
1,380 Kg / 0,0453 m³
E27 max 1 x 60W
014920 € 104

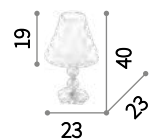

IP20
1,210 Kg / 0,0244 m³
E27 max 1 x 60W
016016 € 84

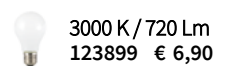
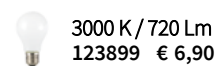



122885

Kate

Corpo luce con elementi di cristallo pieno molato trasparente. Paralumi in tessuto doppio.

ON
OFF Lampada con interruttore integrato.



122878

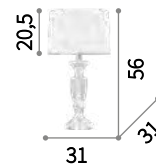

IP20
2,990 Kg / 0,0605 m³
E27 max 1 x 60W
122878 € 220

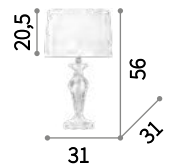

IP20
2,810 Kg / 0,0605 m³
E27 max 1 x 60W
122885 € 220

3000 K / 720 Lm
123899 € 6,90

3000 K / 720 Lm
123899 € 6,90



Voga

Base e corpo luce in vetro trasparente soffiato e lavorato a mano. Diffusore in lamina di PVC rivestita di tessuto bianco.

 Lampada con interruttore integrato.

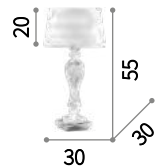

 IP20

2,500 Kg / 0,0759 m³

E27 max 1x60W

001180 € 165

 3000 K / 720 Lm
123899 € 6,90



Duchessa

Base e dettagli in metallo cromato.
Elementi decorativi in vetro soffiato e
lavorato a mano. Paralume in tessuto di
organza plissettato.

ON
OFF Lampada con interruttore integrato.

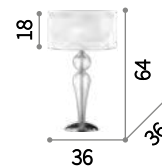

IP20
3,000 Kg / 0,0652 m³
E27 max 1 x 60W
044491 € 125

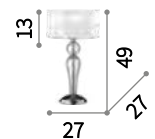

IP20
1,900 Kg / 0,0521 m³
E27 max 1 x 60W
051406 € 105

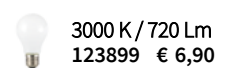
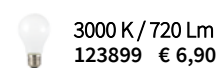

Classico

Lampade da terra



Bin 546



Culto 547



Kraken 548



Maurien 549



Elvis 549



Newton 550



Amsterdam 550



Driftwood 553



Florian 554



Opera 554



Provence 555



Firenze 555



Pegaso 556



Paris 556



Forcola 559



Dorothy 559



Beverly 551



Kronplatz 551



Biva-50 552



Step 557



Queen 558



Le Roy 558

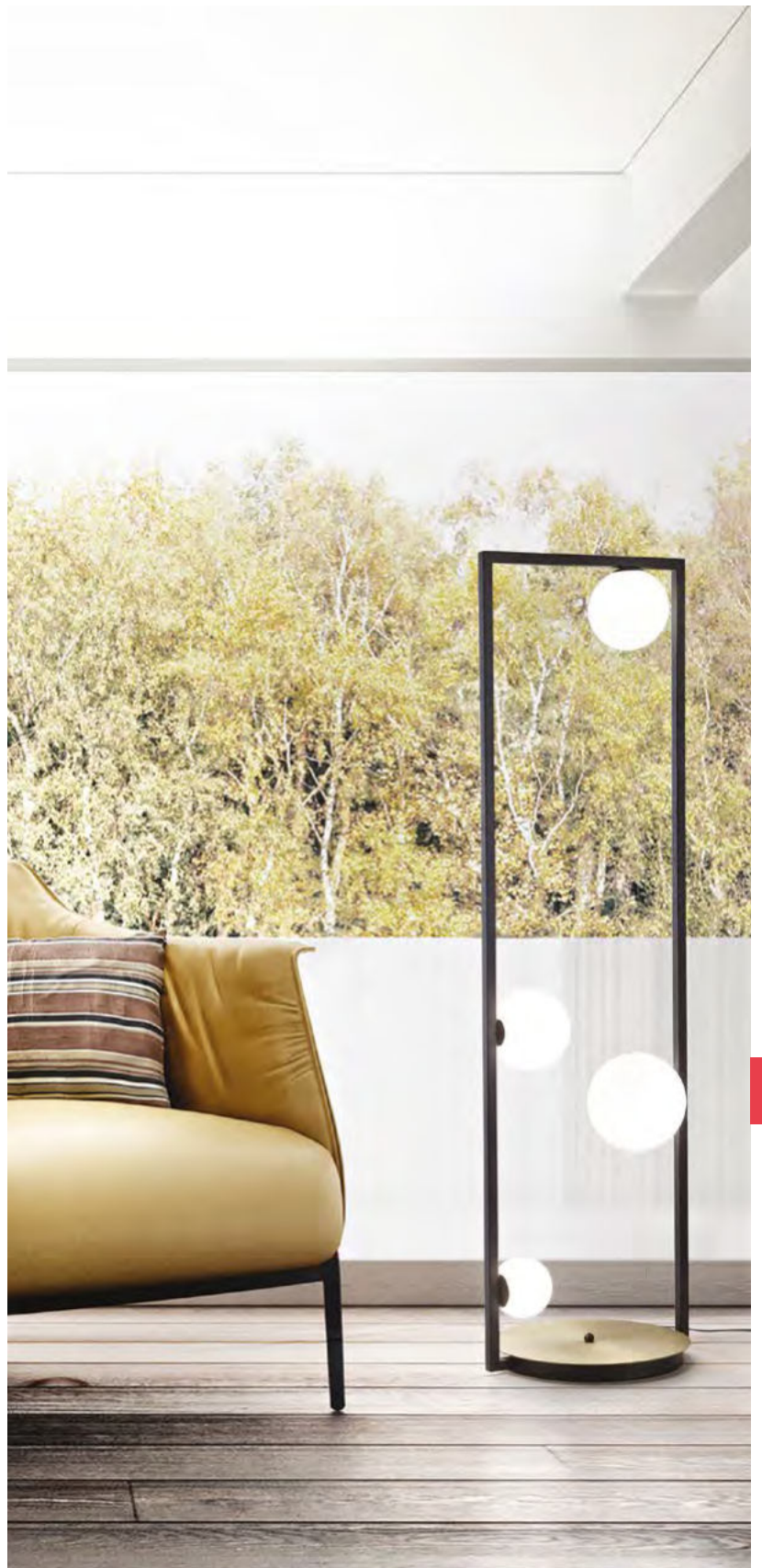

Culto

Pag 547



Bin

Montatura e diffusore in metallo rifinito con vernice opaca nera. Braccio snodato regolabile. Diffusore orientabile.

ON **OFF** Lampada con interruttore integrato.

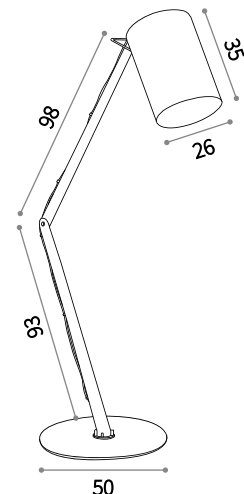

IP20

13,810 Kg / 0,0237 m³
E27 max 1x42W

144849 ■ € 600

3000 K / 860 Lm
101347 € 8,90



P. 522



Culto **new**

Montatura in metallo verniciato nero opaco e base con elemento in ottone satinato. Diffusori in vetro soffiato bianco, acidato.

LED Lampadine LED G9 3,2W 3000 K incluse. Cod. 209043

ON/OFF Lampada con interruttore integrato.

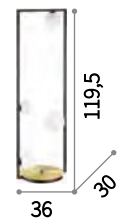

IP20

8,490 Kg / 0,1800 m³
G9 max 4 x 28W

225104 ■ € 355 **new**



P. 331

P. 470

P. 489

P. 522

3000 K / 300 Lm
209043 € 3,50



Kraken

Treppiede in legno verniciato nero opaco. Dettagli e corpo luce in metallo cromato. Diffusore in vetro trasparente con alette interne per l'orientamento del flusso luminoso.



Lampada con interruttore integrato.



IP20

8,030 Kg / 0,0917 m³
E27 max 1x60W

105659 € 650

3000 K / 860 Lm
101323 € 7,90

Maurien

Montatura interamente in metallo verniciato a polveri. Diffusori orientabili e regolabili in altezza.

ON
OFF Lampada con interruttore integrato.



IP20

8,240 Kg / 0,0824 m³
E27 max 3 x 42W

199528 € 260

3000 K / 860 Lm
119571 € 6,50



Elvis

Montatura in metallo cromato. Diffusore orientabile in metallo colorato e dettagli in cromo all'esterno, smaltato bianco all'interno.

ON
OFF Lampada con interruttore integrato.

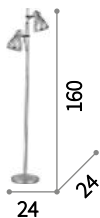

IP20

3,600 Kg / 0,0277 m³
E27 max 2 x 60W

042794 € 110
001197 € 110

3000 K / 860 Lm
119571 € 6,50



042794

Newton

Montatura e diffusore in metallo.
Disponibile con finitura in nickel satinato
o con vernice nera opaca. Braccio
regolabile. Diffusore orientabile smaltato
bianco all'interno.

ON
OFF Lampada con interruttore integrato.

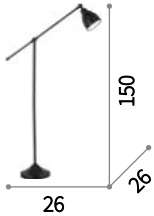

IP20

5,270 Kg / 0,0323 m³
E27 max 1 x 60W

015286 € 136
003528 € 88

3000 K / 720 Lm
123899 € 6,90

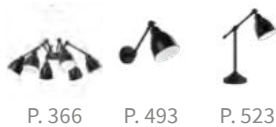

P. 366

P. 493

P. 523



003528

015286

Amsterdam

Montatura in metallo rifinito brunito.
Braccio regolabile in altezza. Diffusore
orientabile.

ON
OFF Lampada con interruttore integrato.



IP20

5,290 Kg / 0,1505 m³
E27 max 1 x 60W

129242 € 269

3000 K / 860 Lm
119571 € 6,50



P. 526



Beverly

Montatura in metallo con finitura in ottone satinato o in cromo. Braccio snodato regolabile. Paralume in lamina di PVC rivestito in tessuto.

ON
OFF Lampada con interruttore integrato.

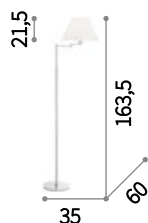

IP20

4,760 Kg / 0,0660 m³
E27 max 1 x 60W

126807 € 170
140315 € 200

3000 K / 720 Lm
101354 € 9,00

P. 497



140315

126807

Kronplatz

Montatura in metallo cromato. Paralume in lamina di PVC rivestita con tessuto canvas.

ON
OFF Lampada con interruttore integrato.

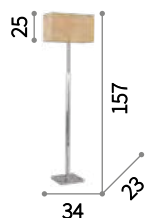

IP20

5,590 Kg / 0,1303 m³
E27 max 1 x 60W

110882 € 200

3000 K / 860 Lm
101323 € 7,90

P. 441

P. 530





Biva-50

Corpo luce in resina decorato a mano e finale in metallo cromato. Paralume in doppio tessuto: bianco all'interno e plissettato in color canapa all'esterno.

ON **OFF** Lampada con interruttore integrato.

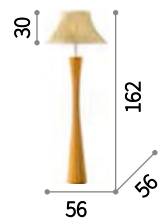

IP20

7,740 Kg / 0,2124 m³
E27 max 1 x 60W

015750 € 370

3000 K / 860 Lm
101347 € 8,90



Driftwood

Montatura in metallo. Elementi decorativi con rami di legno naturale. Diffusore in lamina di pvc rivestito con tessuto canvas.

ON
OFF Lampada con interruttore integrato.

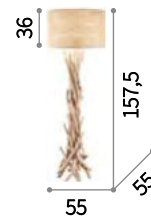

IP20
5,830 Kg / 0,3487 m³
E27 max 1 x 60W
148939 € 520



IP20
24,000 Kg / 0,1753 m³
E27 max 2 x 60W
180946 € 590



P. 449



P. 532



2200 K / 300 Lm
151687 € 4,90



2200 K / 300 Lm
151687 € 4,90

Florian

Montatura in metallo con elementi decorativi in vetro. Pendagli con ottagoni e gocce finali in cristallo molato.

 Lampada con interruttore integrato.

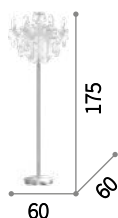

 IP20

12,200 Kg / 0,1910 m³
E14 max 6 x 60W

179902  € 428



3000 K / 430 Lm
101224 € 2,90



P. 388



P. 503



Opera

Montatura in cromo. Paralume in lamina di PVC con riflessi metallizzati e rivestita da fili. Pendagli in cristallo molato.

 Lampada con interruttore integrato.

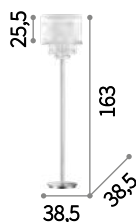

 IP20

5,720 Kg / 0,0770 m³
E27 max 1 x 60W

068275  € 235



3000 K / 720 Lm
101354 € 9,00



P. 434



P. 511



P. 536



Provence

Corpo luce in legno tornito e bracci in metallo. Finitura con vernice opaca. Paralumi in lamina di PVC rivestita in tessuto a trama grossa.

ON
OFF Lampada con interruttore integrato.



IP20

4,900 Kg / 0,0989 m³

E27 max 1 x 60W

022987 € 214

3000 K / 860 Lm
101347 € 8,90



P. 420



P. 531



Firenze

Corpo luce in resina. Bracci e foglie in metallo modellato artigianalmente. Decorato a mano con foglia d'oro e antichizzato.

ON
OFF Lampada con interruttore integrato.

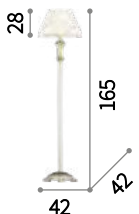

IP20

5,600 Kg / 0,1089 m³

E27 max 1 x 60W

002880 € 253

020877 € 253

3000 K / 860 Lm
101347 € 8,90



P. 451



P. 514



P. 531



002880



002880

Pegaso

Montatura in metallo cromato. Corpo centrale, bobeches e pendagli in cristallo molato. Paralumi in organza.

 Lampada con interruttore integrato.

 Lampada con dimmer.

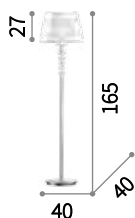

5,450 Kg / 0,0985 m³
E27 max 1 x 60W

059228 € 262

 3000 K / 720 Lm
101354 € 9,00



P. 414



P. 507



P. 537



Paris

Montatura in nickel satinato. Bobeches in cristallo molato. Paralume in lamina di PVC rivestita da fili argentati.

 Lampada con interruttore integrato.

 Lampada con dimmer.

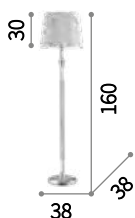

4,430 Kg / 0,0894 m³
E27 max 1 x 60W

014968 € 216

 3000 K / 860 Lm
101347 € 8,90



P. 437



P. 539





Step

Corpo luce in metallo cromato decorato con sfere di vetro. Paralume in lamina di PVC rivestita di tessuto bianco con fantasia floreale in rilievo.

 Lampada con interruttore integrato.

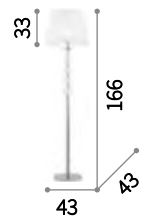

 IP20

8,380 Kg / 0,1255 m³
E27 max 1x100W

032313 € 287



P. 537



3000 K / 720 Lm
101354 € 9,00

Queen

Montatura in metallo dorato con elementi decorativi e base in cristallo molato. Paralume in lamina di PVC, rivestita in tessuto con decorazione trapuntata e brillantini dorati.

 Lampada con interruttore integrato.



 IP20

4,900 Kg / 0,0979 m³

E27 max 1 x 60W

077765  € 274

 3000 K / 860 Lm
101347 € 8,90



P. 437



P. 538



Le Roy

Montatura e base in metallo cromato con elementi decorativi in cristallo molato. Paralume in lamina di PVC, rivestita in tessuto con decorazione trapuntata e brillantini argentati.

 Lampada con interruttore integrato.

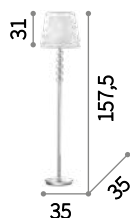

 IP20

4,900 Kg / 0,0934 m³

E27 max 1 x 60W

073392  € 250

 3000 K / 860 Lm
101347 € 8,90



P. 538



Forcola

Montatura e dettagli in metallo cromato. Corpo luce in vetro trasparente soffiato e lavorato a mano. Diffusore in lamina di PVC rivestita di tessuto.

 Lampada con interruttore integrato.

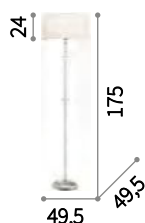

 IP20

8,480 Kg / 0,2518 m³

E27 max 1 x 60W

142616 € 400

 3000 K / 720 Lm
101354 € 9,00



Dorothy

Base e struttura centrale in metallo cromato. Elementi decorativi in vetro soffiato e lavorato a mano. Paralume in lamina di PVC, rivestita in tessuto.

 Lampada con interruttore integrato.

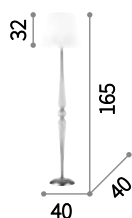

 IP20

5,040 Kg / 0,1850 m³

E27 max 1 x 100W

035369 € 274

 3000 K / 720 Lm
101354 € 9,00



Tecnico

Lampade a sospensione



Oracle 562



Oracle 562



Oracle Slim 563



Halo 564



Stadium 565



Ufo 566



Polo 567



Look 568



Sky 570



Ultrathin 572



Tube 574



Oak 575



Oak 575



Desk 576



Club 577



Oracle Slim

Pag 563



Oracle **new**

Rosone e corpo luce in alluminio verniciato a polveri di colore bianco o nero. Diffusore in materiale plastico color opale. Sorgente luminosa a led integrati.

LED Sorgente luminosa LED 3000 K, 20.000 h di durata.

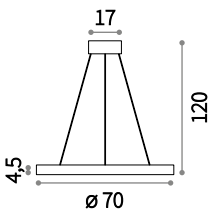

IP20

2,160 Kg / 0,0353 m³
LED 43W / 2850 Lm

211381 € 370
222110 € 370

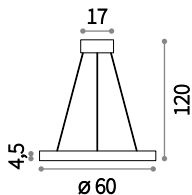

IP20

1,870 Kg / 0,0260 m³
LED 38W / 2500 Lm

211398 € 320
222103 € 320

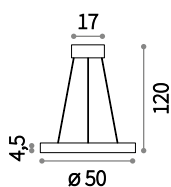

IP20

1,640 Kg / 0,0169 m³
LED 31W / 2000 Lm

211404 € 270
222097 € 270

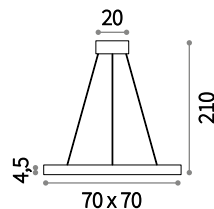

IP20

3,400 Kg / 0,0306 m³
LED 43W / 2800 Lm

245706 € 425 **new**
245713 € 425 **new**

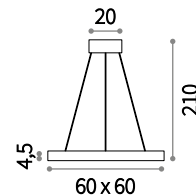

IP20

2,870 Kg / 0,0220 m³
LED 39W / 2500 Lm

245683 € 345 **new**
245690 € 345 **new**

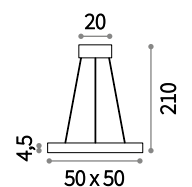

IP20

2,460 Kg / 0,0169 m³
LED 35W / 2300 Lm

245669 € 290 **new**
245676 € 290 **new**



Oracle Slim ^{new}

Montatura in metallo verniciato bianco o nero opaco. Diffusore in materiale plastico opale. Cavo elettrico in pvc trasparente.

LED Sorgente luminosa LED 3000 K, 17.500 h di durata.



IP20	IP20	IP20
1,800 Kg / 0,0651 m ³ LED 48W / 3000 Lm	1,660 Kg / 0,0252 m ³ LED 35W / 2100 Lm	1,400 Kg / 0,0130 m ³ WWLED 29W / 1600 Lm
229478 € 245 ^{new} 229508 € 245 ^{new}	229485 € 200 ^{new} 229515 € 200 ^{new}	229461 € 165 ^{new} 229492 € 165 ^{new}



Halo

Base e corpo luce in alluminio verniciato a polveri. Diffusore in materiale plastico color opale. Sorgente luminosa a led integrati.

LED Sorgente luminosa LED 3000/4000 K, 35.000 h di durata.

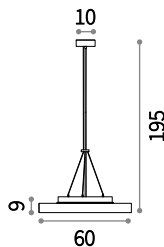

IP20

7,100 Kg / 0,0583 m³
LED 44W / 4300/5000 Lm
226743 3000K € 470
226750 4000K € 470

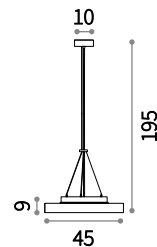

IP20

4,930 Kg / 0,0329 m³
LED 31W / 2800/3200 Lm
226729 3000K € 320
226736 4000K € 320

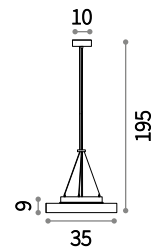

IP20

3,250 Kg / 0,0194 m³
LED 25W / 2200/2500 Lm
226712 3000K € 250
223254 4000K € 250





Stadium

Montatura in metallo rifinito con vernice opaca. Cavi regolabili in lunghezza. Diffusore acrilico. LED integrati.

LED Sorgente luminosa LED 3000 K, 20.000 h di durata.

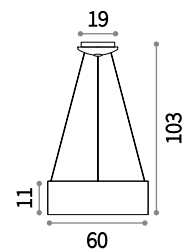

IP20

2,110 Kg / 0,0634 m³
LED 36W / 2160 Lm

153124 € 376

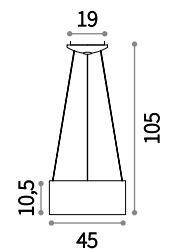

IP20

1,680 Kg / 0,0368 m³
LED 28W / 1680 Lm

157030 € 266



Ufo

Montatura in metallo verniciato bianco o nero opaco. Diffusore in materiale plastico bianco satinato con LED integrati.

LED Sorgente luminosa LED 3000 K, 30.000 h di durata.

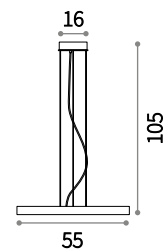

IP20

6,200 Kg / 0,0567 m³
LED 48,5W / 4060 Lm

103709 € 466

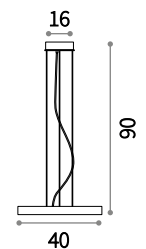

IP20

3,950 Kg / 0,0346 m³
LED 36W / 2900 Lm

103693 € 340



P. 711



Polo

Rosone e montatura in metallo verniciato bianco opaco. Diffusore in policarbonato bianco opaco. Sospensioni con cavi in acciaio regolabili in lunghezza da dispositivi automatici.

LED Sorgente luminosa LED 3000 K, 30.000 h di durata.

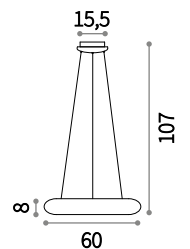

IP20

2,400 Kg / 0,0663 m³
LED 41W / 5600 Lm

140520 € 430



P. 710



Look

Rosone e diffusore in metallo con varie finiture. Cavo in tessuto regolabile in lunghezza. Monta lampadine sostituibili. Modello con finitura cromo sfumato con diffusore in vetro.

 Lampadine alogene GU10 28W e GU10 50W 2700 K incluse.



104935 141800 104942 104928



141817 141794 141855 170589



P. 650 P. 714 P. 730

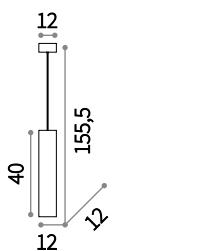

2,950 Kg / 0,0092 m³
GU10 max 1 x 50W

158655 € 100
158686 € 120
187686 € 120
158723 € 100

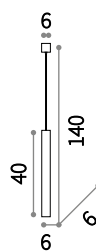

0,990 Kg / 0,0029 m³
GU10 max 1 x 28W

104935 € 60
104942 € 80
141800 € 80
141817 € 80
141855 € 80

141794 € 80
170589 € 80
104928 € 60

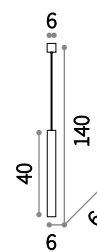

0,990 Kg / 0,0029 m³
GU10 max 1 x 28W

194806 € 90

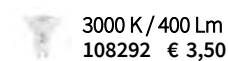
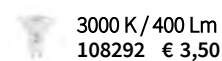
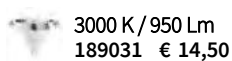

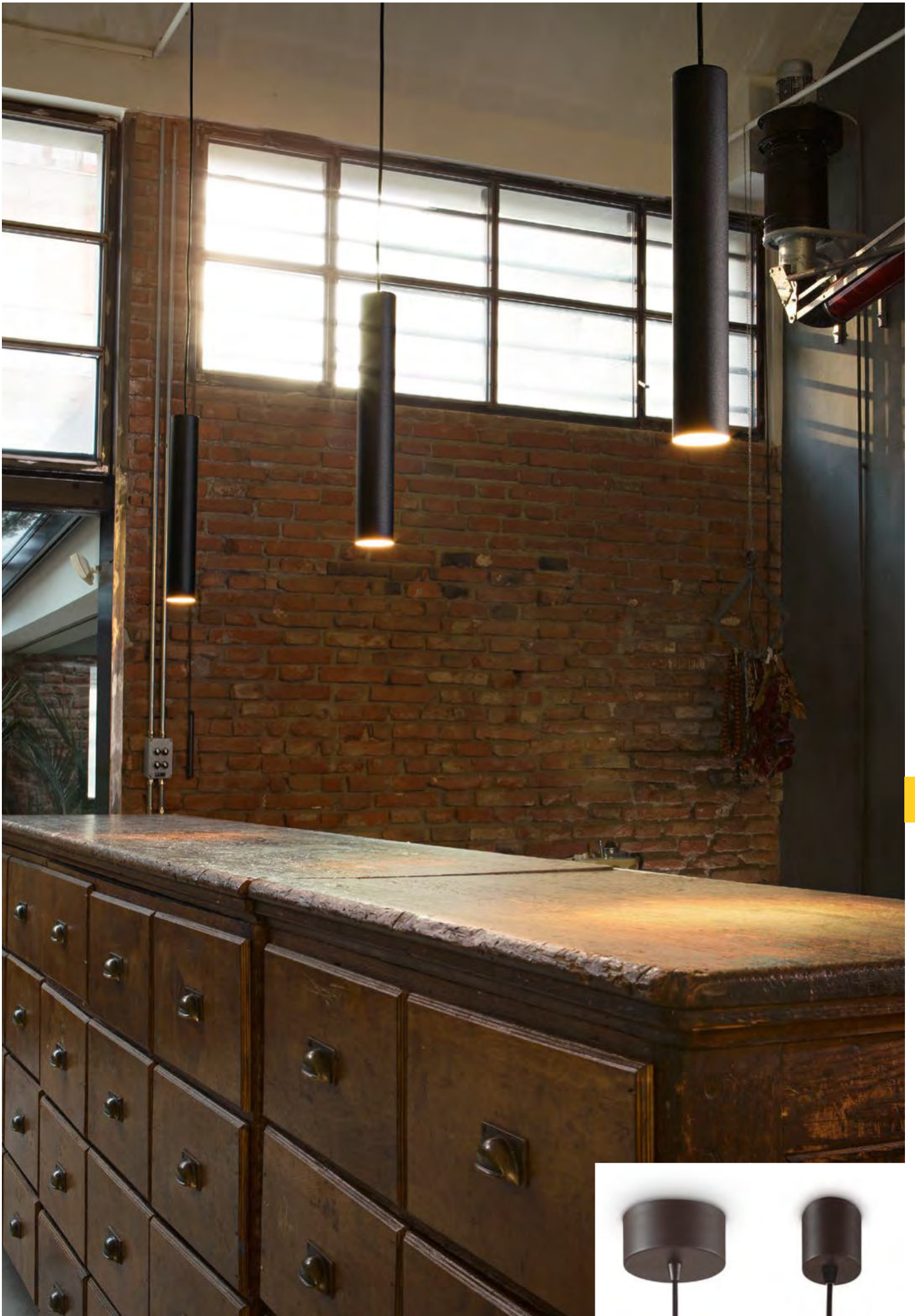



Sky

Rosone e diffusore in metallo con varie finiture. Cavo elettrico regolabile in lunghezza.

 Lampadine alogene GU10 28W 2700 K incluse.

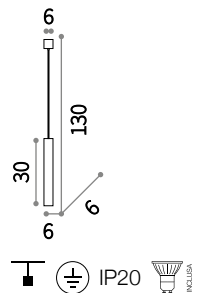

0,950 Kg / 0,0043 m³
GU10 max 1x28W

- 126906 € 70
- 136943 € 100
- 136929 € 100
- 136936 € 100
- 170596 € 100
- 126913 € 70

 3000 K / 400 Lm
108292 € 3,50





126906





Ultrathin

Rosone e diffusore in metallo con finitura cromo o in vernice opaca bianca o nera.

LED Sorgente luminosa LED 3000 K, 30.000 h di durata.

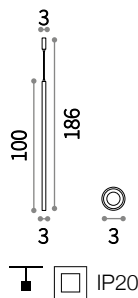

0,670 Kg / 0,0033 m³
LED 11,5W / 1000 Lm / 51°

142906 € 92
164878 € 112
142913 € 92

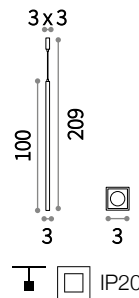

0,860 Kg / 0,0020 m³
LED 11,5W / 1000 Lm / 51°

194172 € 134
194196 € 134

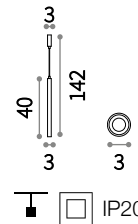

0,460 Kg / 0,0036 m³
LED 11,5W / 1000 Lm / 51°

156682 € 70
187662 € 84
156699 € 70

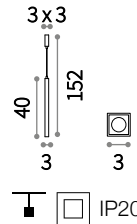

0,450 Kg / 0,0010 m³
LED 11,5W / 1000 Lm / 51°

194189 € 120
194202 € 120

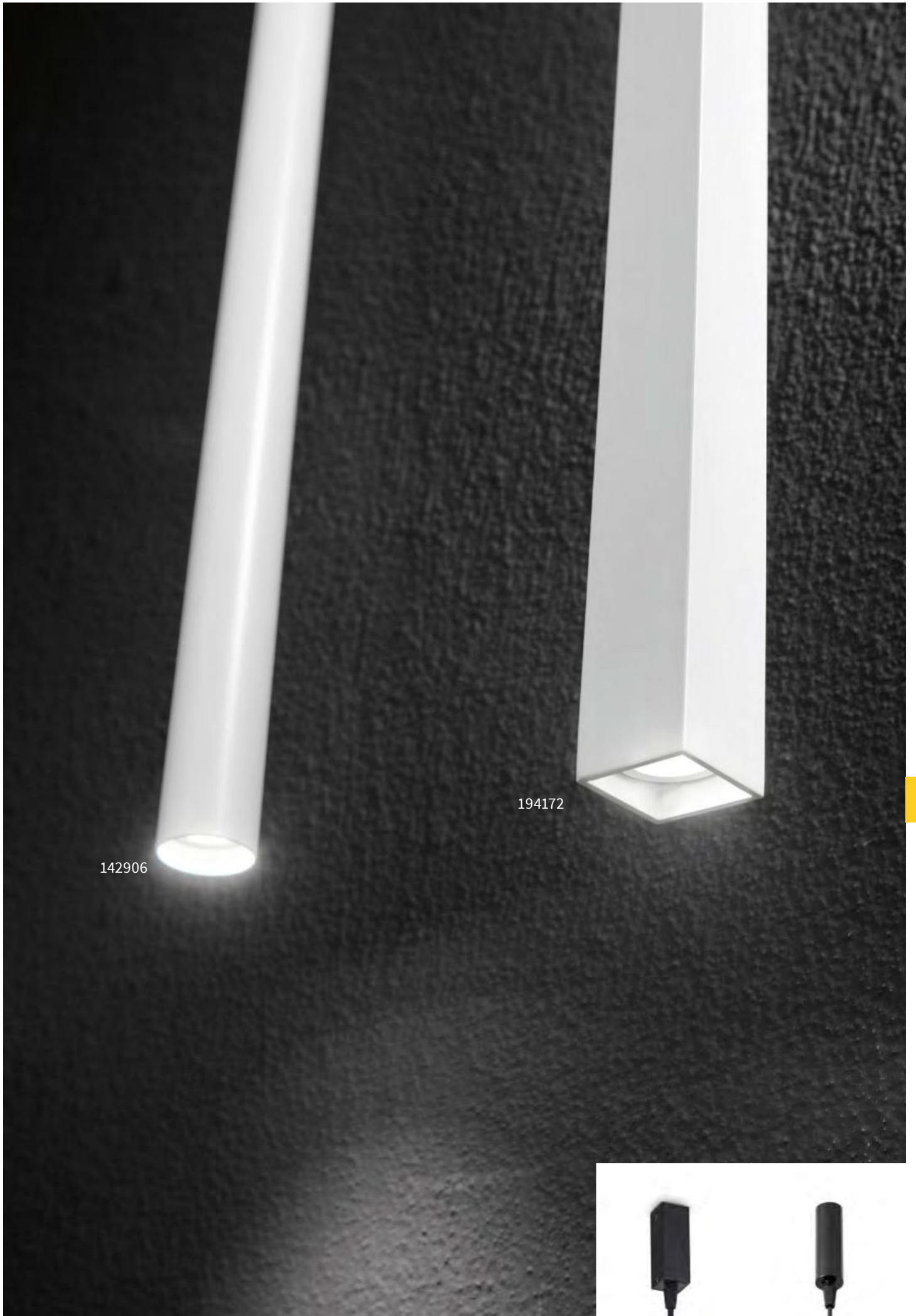

142906

194172



Tube

Rosone e corpo luce in alluminio verniciato a polveri di colore bianco o nero. Cavo in tessuto. Sorgente luminosa a led integrati.

LED Sorgente luminosa LED 3000 K, 35.000 h di durata.

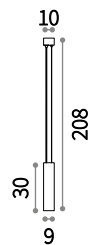

IP20

1,320 Kg / 0,0069 m³
LED 14W / 1300 Lm

211749 € 180
211756 € 180

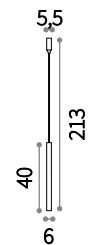

IP20

0,960 Kg / 0,0073 m³
LED 9,5W / 1000 Lm

211701 € 150
211718 € 150

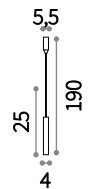

IP20

0,680 Kg / 0,0048 m³
LED 9W / 850 Lm

211459 € 100
211466 € 100



150673

Oak

Corpo luce in gesso o cemento. Cavo in tessuto nero.

 Articolo adatto alla pittura e verniciatura.

150666

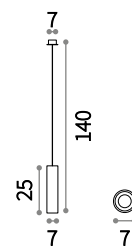

1,220 Kg / 0,0055 m³
GU10 max 1 x 35W

150628 € 60
150635 € 60

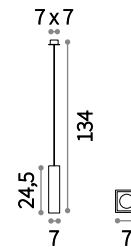



1,720 Kg / 0,0055 m³
GU10 max 1 x 35W

150666 € 60
150673 € 60



P. 718

 3000 K / 560 Lm
101378 € 6,50

 3000 K / 560 Lm
101378 € 6,50



138237



Desk **new**

Corpo luce e rosone in alluminio rifinito con vernice a polveri color bianco o nero opaco. Sospensione con cavi elettrici regolabili in lunghezza.

LED Sorgente luminosa LED 3000 K, 30.000 h di durata.



231235

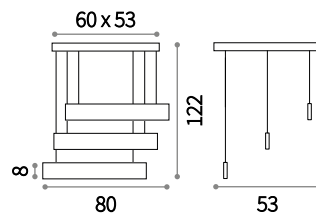

IP20

11,350 Kg / 0,0982 m³
LED 50W / 3000 Lm

231211 € 450 **new**
231235 € 450 **new**

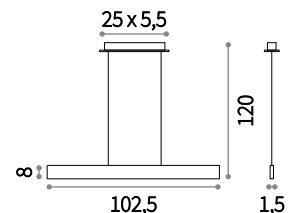

IP20

1,890 Kg / 0,0196 m³
LED 23W / 2100 Lm

138237 € 260
173245 € 260 **new**



138008



Club **new**

Corpo luce e rosone in alluminio verniciato in bianco o nero opaco. Cavi in acciaio regolabili in lunghezza da dispositivi automatici.

LED Sorgente luminosa LED 3000 K, 30.000 h di durata.

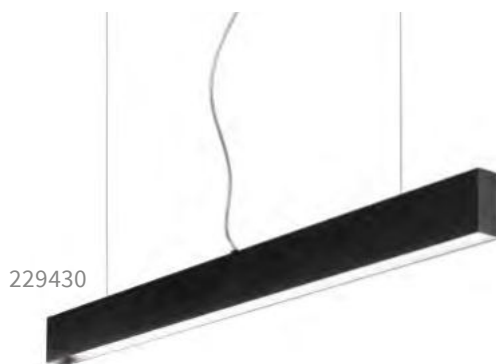

229430

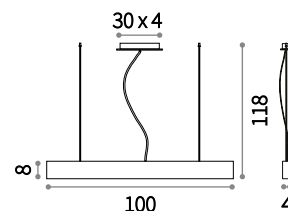

IP20

1,840 Kg / 0,0183 m³
LED 23,5W / 1440 Lm

138008 € 215
229430 € 215 **new**

Tecnico

Sistemi lineari



Arca Track 582



Arca Accent 584



Arca Wide 586



Arca Pendant 588



Oxy Single 596



Oxy Double 598



Oxy Accent 600



Oxy Wide 600



Oxy Pendant 602



Fluo Accent 608



Fluo Wide 610



Fluo Bi-Emission 612



Draft 616



Linus 618



Slot 622



Slot 622



Slot 622



Slot 624



Slot 624



Linus

Pag 618



Arca **new**

Sistema lineare in alluminio estruso compatibile con un'ampia scelta di apparecchi illuminanti a fissaggio meccanico. Il sistema è anodizzato e verniciato. Disponibile in colore nero e nelle modalità d'installazione a plafone, a sospensione oppure a incasso a filo in soffitti di cartongesso. Moduli componibili a seconda della disposizione desiderata. La sezione della scocca per le versioni a soffitto e a sospensione è larga 42 mm e alta 85 mm, mentre quella per la versione a incasso è larga 86 mm e alta 90 mm. Entrambi i modelli sono disponibili in due lunghezze: 1000 mm e 3000 mm. Possibilità di assemblaggio con diversi moduli sorgente: il modulo WIDE diffondente, il modulo ACCENT con controllo dell'UGR inferiore a 13, i moduli TRACK oppure PENDANT per un'illuminazione SPOT con differenti angoli di emissione. Il modulo CORNER per composizioni angolari. LED integrati, possibilità di temperatura di colore di 3000 K o di 4000 K; binning iniziale ≤ 3 -Step MacAdam; protezione IP20; classe isolamento III. L'alimentazione in 48Vdc conferisce grande versatilità e sicurezza, con composizioni reversibili e modificabili all'occorrenza. Sistema adatto per ambienti dove viene richiesta un'illuminazione professionale dal design minimale, come ad esempio UFFICI e spazi COMMERCIALI.

Sorgente	LED COB / SMD
Driver incluso	No
Driver disponibili	On/Off
MacAdam	SDCM 3
CCT	3000K / 4000K
CRI	≥ 80
UGR	< 16 (Accent, Pendant)
Durata LED	50.000h
Classe isolamento	III
IP	20
Materiale	Alluminio
Garanzia	5 anni





Arca Track

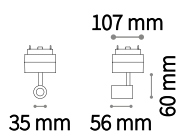

LED SMD CREE

Potenza	Angolo	Flux	CCT	Finitura	Codice	€
5,5 W	34°	440 Lm	3000 K	Nero	■ 222974	86
		460 Lm	4000 K	Nero	■ 223056	86



90° 355° 0,200 Kg/0,0015 m³

OPTIONAL Non incluso



	Angolo	Codice	€
Lente	20°	223087	6

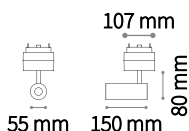

LED COB CITIZEN

Potenza	Angolo	Flux	CCT	Finitura	Codice	€
14 W	36°	1400 Lm	3000 K	Nero	■ 222967	112
		1500 Lm	4000 K	Nero	■ 223049	112



90° 355° 0,460 Kg/0,0030 m³

OPTIONAL Non incluso

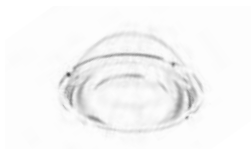

	Angolo	Codice	€
Lente	18°	223094	6

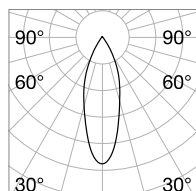

m	lx	øm
1	553	0,58
2	138	1,16
3	61	1,75
4	35	2,33
5	22	2,91

CRI≥80 5,5W 34° 440 Lm 3000 K

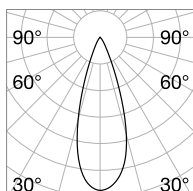

m	lx	øm
1	2336	0,60
2	584	1,21
3	259	1,81
4	146	2,42
5	93	3,02

CRI≥80 14W 36° 1400 Lm 3000 K

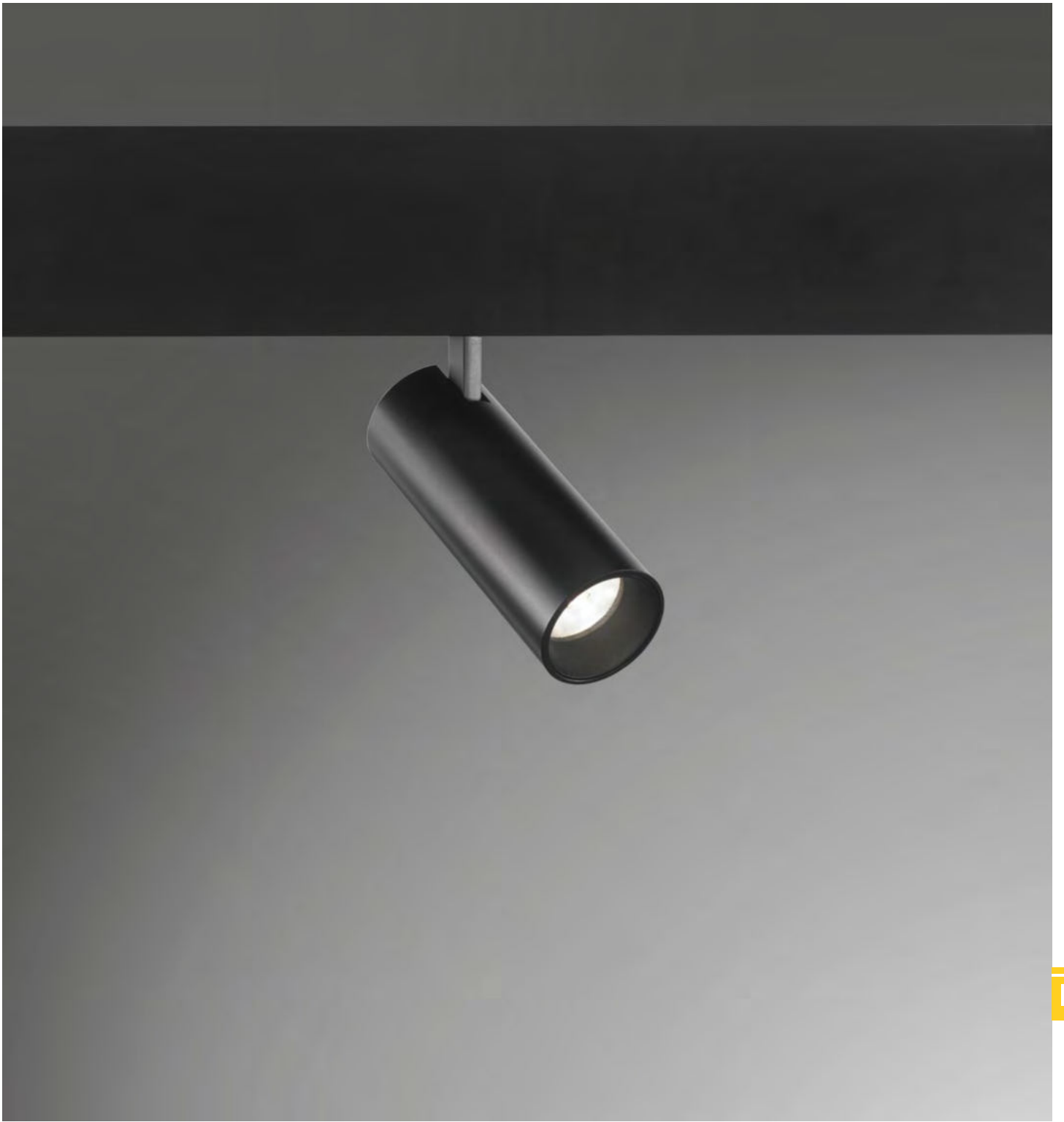

Arca Accent

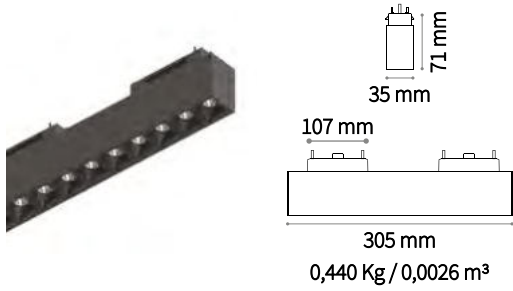

LED SMD OSRAM UGR <13

Potenza	Angolo	Flux	CCT	Finitura	Codice	€
15 W	35°	2000 Lm	3000 K	Nero	■ 222929	134
		2100 Lm	4000 K	Nero	■ 223001	134

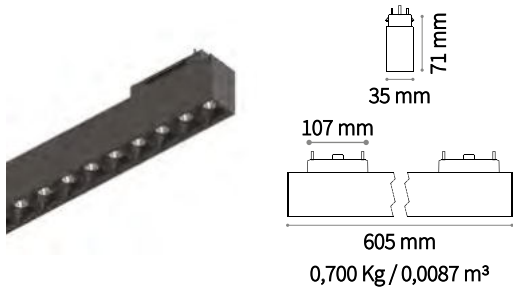

LED SMD OSRAM UGR <13

Potenza	Angolo	Flux	CCT	Finitura	Codice	€
29 W	35°	3650 Lm	3000 K	Nero	■ 222936	230
		3850 Lm	4000 K	Nero	■ 223018	230

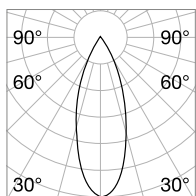

m	lx	øm
1	2707	0,56
2	676	1,13
3	300	2,26
4	169	2,83
5	108	3,39

CRI≥80 15W 35° 2000 Lm 3000 K

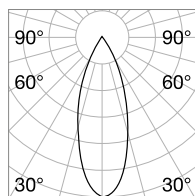

m	lx	øm
1	4826	0,60
2	1207	1,21
3	536	1,81
4	301	2,42
5	193	3,02

CRI≥80 29W 35° 3650 Lm 3000 K



Arca Accent 300 mm



Arca Accent 600 mm



Arca Wide

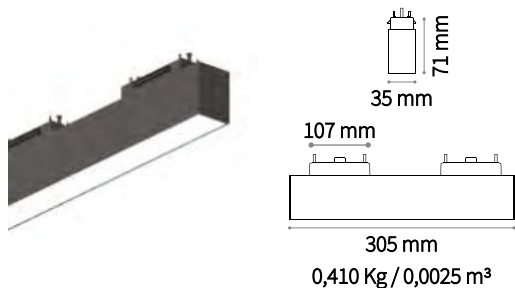

LED SMD SAMSUNG

Potenza	Angolo	Flux	CCT	Finitura	Codice	€
13 W	98°	1950 Lm	3000 K	Nero	■ 222943	80
		2100 Lm	4000 K	Nero	■ 223025	80

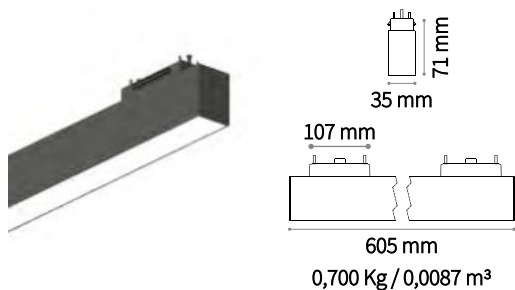

LED SMD SAMSUNG

Potenza	Angolo	Flux	CCT	Finitura	Codice	€
25 W	98°	4000 Lm	3000 K	Nero	■ 222950	118
		4300 Lm	4000 K	Nero	■ 223032	118

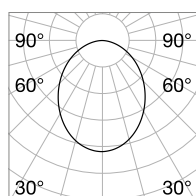

m	lx	ø m
1	203	2,16
2	50	4,33
3	22	6,50
4	12	8,66
5	8	10,83

CRI≥80 13W 98° 1950 Lm 3000 K

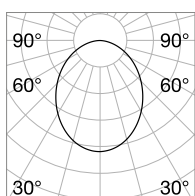

m	lx	ø m
1	440	2,14
2	110	4,28
3	48	6,42
4	27	8,56
5	17	10,70

CRI≥80 25W 98° 4000 Lm 3000 K



Arca Wide 300 mm



Arca Wide 600 mm



Arca Pendant

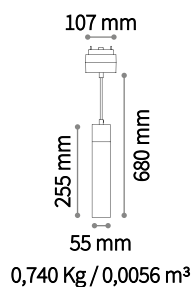

LED COB CITIZEN UGR <13

Potenza	Angolo	Flux	CCT	Finitura	Codice	€
15 W	34°	1450 Lm	3000 K	Nero	■ 222981	134
		1500 Lm	4000 K	Nero	■ 223063	134

Lunghezza cavi 500 mm

OPTIONAL Non incluso



	Angolo	Codice	€
Lente	18°	223285	6

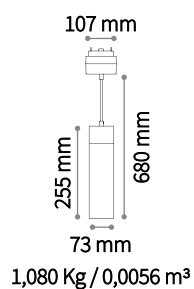

LED COB CITIZEN UGR <16

Potenza	Angolo	Flux	CCT	Finitura	Codice	€
21 W	30°	2650 Lm	3000 K	Nero	■ 222998	155
		2800 Lm	4000 K	Nero	■ 223070	155

Lunghezza cavi 500 mm

OPTIONAL Non incluso



	Angolo	Codice	€
Lente	15°	223292	6

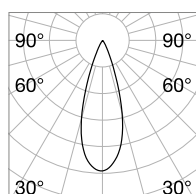

m	lx	øm
1	2410	0,59
2	602	1,19
3	268	1,78
4	151	2,38
5	96	2,98

CRI≥80 15W 34° 1450 Lm 3000 K

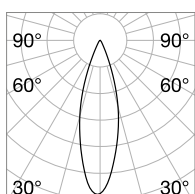

m	lx	øm
1	4788	0,51
2	1197	1,03
3	532	1,55
4	299	2,06
5	191	2,58

CRI≥80 21W 30° 2650 Lm 3000 K

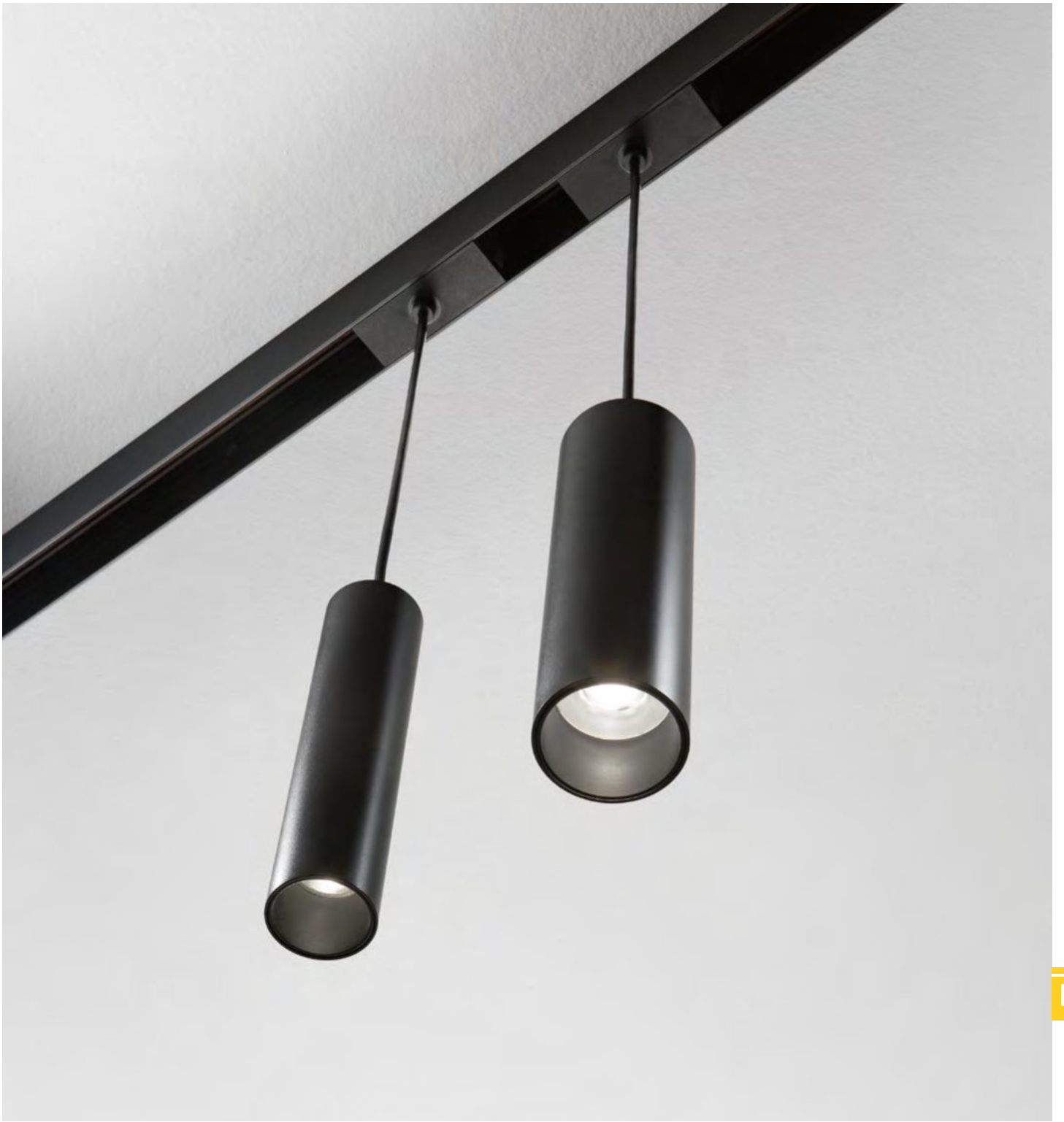

Arca - Pendant

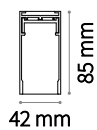

TRACK

Lunghezza	Peso	Volume	Finitura	Codice	€
1000 mm	1,34 Kg	0,0247 m ³	Nero	222745	102
3000 mm	4,16 Kg	0,0613 m ³	Nero	222752	272

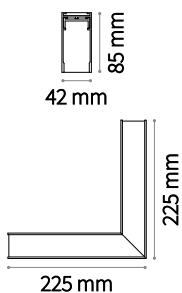

BLINDED CORNER RIGHT - LEFT Non incluso/Optional

Peso	Volume	Finitura	Codice	€
0,65 Kg	0,0090 m ³	Nero	243641	76 <small>new</small>



SUSPENSION KIT Non incluso/Necessario - 1 kit x 2000 mm

Rosone	N° Cavi	Lunghezza cavi	Finitura	Codice	€
No	2	2000 mm	Grigio	222905	23



END CAP Non incluso/Necessario

Codice	€
223148	13



ELECTRIFIED END CAP Non incluso/Necessario

Lunghezza cavi	Codice	€
2150 mm	223131	20

Arca - Surface

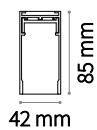

TRACK

Lunghezza	Peso	Volume	Finitura	Codice	€
1000 mm	1,34 Kg	0,0247 m ³	Nero	222745	102
3000 mm	4,16 Kg	0,0613 m ³	Nero	222752	272

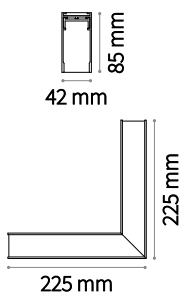

BLINDED CORNER RIGHT - LEFT Non incluso/Optional

Peso	Volume	Finitura	Codice	€
0,65 Kg	0,0090 m ³	Nero	243641	76 <small>new</small>

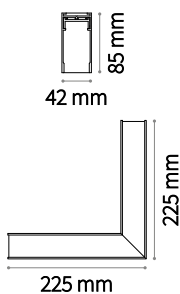

BLINDED CORNER VERTICAL - HORIZONTAL Non incluso/Optional

Peso	Volume	Finitura	Codice	€
0,65 Kg	0,0090 m ³	Nero	243658	76 <small>new</small>



MOUNTING KIT Non incluso/Necessario - 1 kit x 1000 mm

Finitura	Codice	€
Grigio	222899	22



END CAP Non incluso/Necessario

Codice	€
223148	13



ELECTRIFIED END CAP Non incluso/Necessario

Codice	€
223124	15



Arca - Recessed

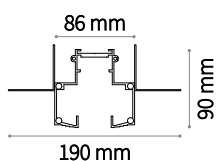

TRACK Kit per montaggio profilo incluso

Lunghezza	Peso	Volume	Finitura	Codice	€
1000 mm	2,90 Kg	0,0269 m ³	Nero	222769	160
3000 mm	7,40 Kg	0,0718 m ³	Nero	222882	410

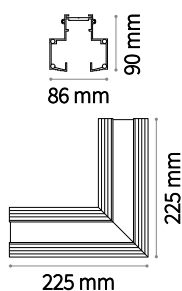

BLINDED CORNER RIGHT - LEFT Non incluso/Optional

Peso	Volume	Finitura	Codice	€
0,98 Kg	0,0090 m ³	Nero	243900	104 <small>new</small>

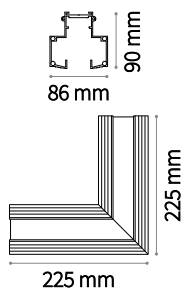
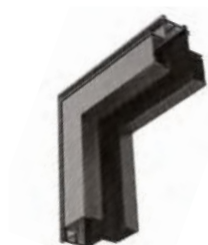

BLINDED CORNER VERTICAL - HORIZONTAL Non incluso/Optional

Peso	Volume	Finitura	Codice	€
0,98 Kg	0,0090 m ³	Nero	243917	104 <small>new</small>



END CAP Non incluso/Necessario

Codice	€
223148	13



ELECTRIFIED END CAP Non incluso/Necessario

Codice	€
223124	15

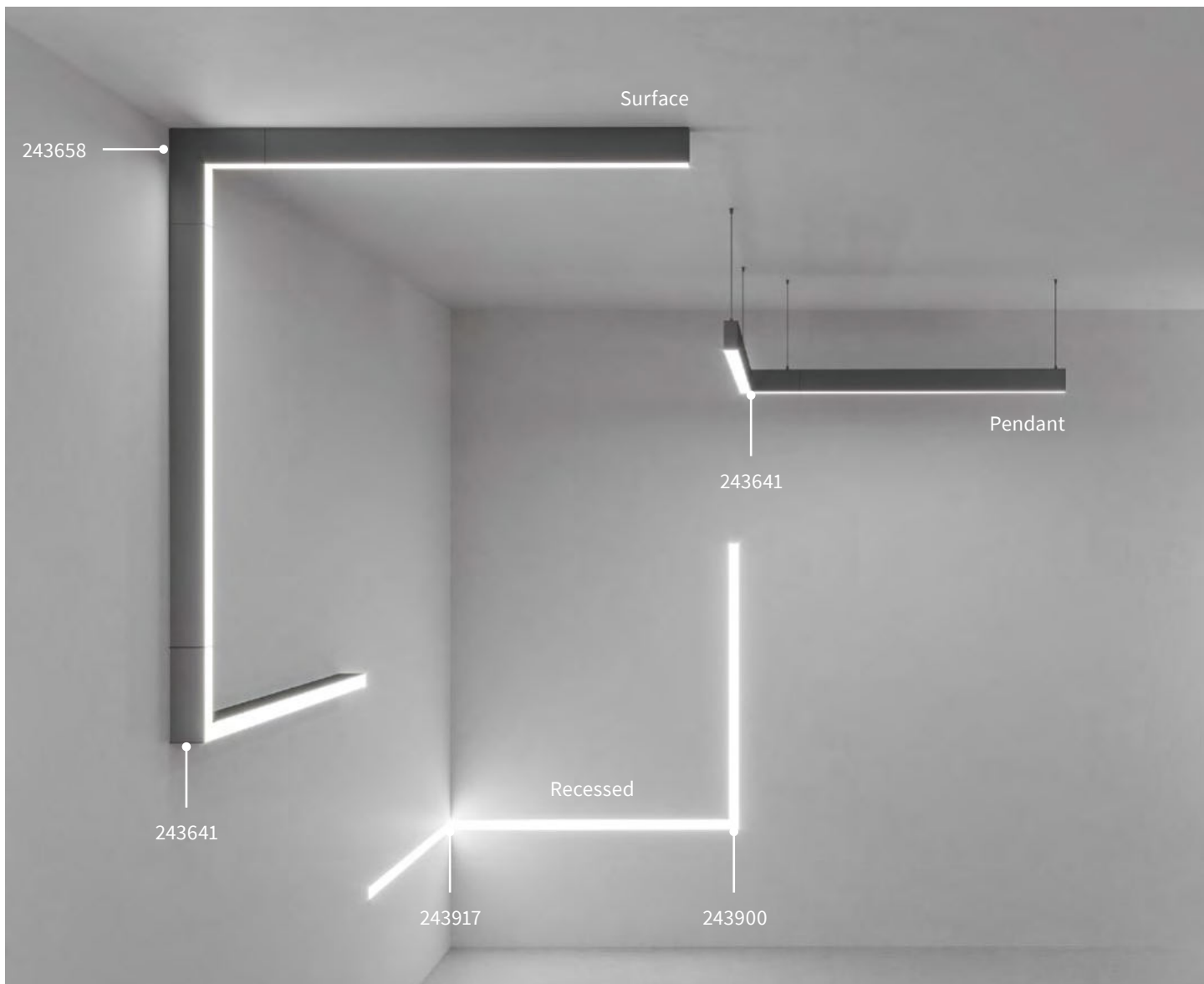

BLINDED COVER Non incluso/Optional

Materiale	Lunghezza	Colore	Codice	€
PC	990 mm	Nero	222912	6



LINEAR CONNECTOR Non incluso/Optional

Codice	€
254944	20



DRIVER MEANWELL ON/OFF Non incluso/Necessario

Potenza	Output	Classe	Misura	Codice	€
60 W	48 Vdc	⊕	171x62x37 mm	223155	112
90 W	48 Vdc	⊕	220x68x37 mm	223162	150
150 W	48 Vdc	⊕	228x68x37 mm	223179	166
240 W	48 Vdc	⊕	244x68x39 mm	224275	213

Oxy **new**

Profilo in alluminio estruso compatibile con elementi di illuminazione a fissaggio magnetico. Il sistema è verniciato a polveri e disponibile in colore nero o bianco nella modalità d'installazione a plafone. I moduli sono componibili a seconda della disposizione desiderata e presentano un controllo di dimmerazione 1-10V integrato. La sezione del profilo è larga 26 mm e alta 27 mm o 52 mm; disponibile in due lunghezze, 2000 mm e 3000 mm. Possibilità di assemblaggio con diversi moduli sorgente: il modulo WIDE diffondente; il modulo ACCENT con controllo dell'UGR inferiore a 13; il modulo TRACK SINGLE oppure DOUBLE per un'illuminazione spot con differenti angoli di emissione e il modulo decorativo PENDANT TUBE. LED integrati, temperatura di colore di 3000 K; Binning iniziale ≤ 2 -Step MacAdam; protezione IP20, classe isolamento III. L'alimentazione in 48 Vdc conferisce grande versatilità e sicurezza, le composizioni sono infatti reversibili e modificabili all'occorrenza. Ideale per l'illuminazione di grandi ambienti dove viene richiesta ampia flessibilità e resa cromatica, ad esempio spazi MUSEALI, COMMERCIALI, RESIDENZIALI e RETAIL.

Sorgente	LED COB / SMD
Driver incluso	No
Controllo	1-10V
MacAdam	SDCM 2
CCT	3000K
CRI	≥ 90
UGR	<16 (Accent, Pendant)
Durata LED	35.000h
Classe isolamento	III
IP	20
Materiale	Alluminio
Garanzia	5 anni





Oxy Track Single

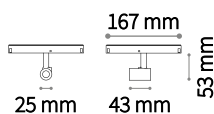

LED COB OSRAM

Potenza	Angolo	Flux	CCT	Finitura	Codice	€
3,5 W	23°	200 Lm	3000 K	Bianco	248905	110 <small>new</small>
				Nero	224107	110



90° 355° 0,100 Kg/0,0020 m³

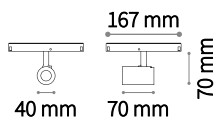

LED COB OSRAM

Potenza	Angolo	Flux	CCT	Finitura	Codice	€
8 W	36°	600 Lm	3000 K	Bianco	248912	130 <small>new</small>
				Nero	224138	130



90° 355° 0,170 Kg/0,0028 m³

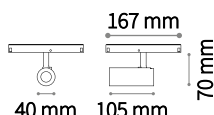

LED COB CITIZEN

Potenza	Angolo	Flux	CCT	Finitura	Codice	€
12 W	34°	980 Lm	3000 K	Bianco	248899	140 <small>new</small>
				Nero	224169	140



90° 355° 0,210 Kg/0,0028 m³

OPTIONAL Non incluso



	Angolo	Codice	€
Lente 3,5 W	12°	224121	3
Lente 8 W	20°	224183	4
Lente 12 W	20°	224183	4

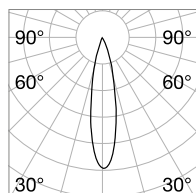

m	lx	øm
1	810	0,39
2	202	0,78
3	90	1,17
4	51	1,56
5	27	1,96

CRI≥90 3,5W 23° 200 Lm 3000 K

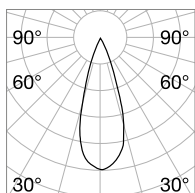

m	lx	øm
1	1569	0,60
2	392	1,20
3	174	1,80
4	98	2,40
5	52	3,00

CRI≥90 8W 36° 600 Lm 3000 K

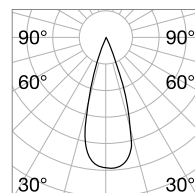

m	lx	øm
1	2493	0,60
2	623	1,21
3	277	1,81
4	156	2,42
5	83	3,02

CRI≥90 12W 34° 980 Lm 3000 K

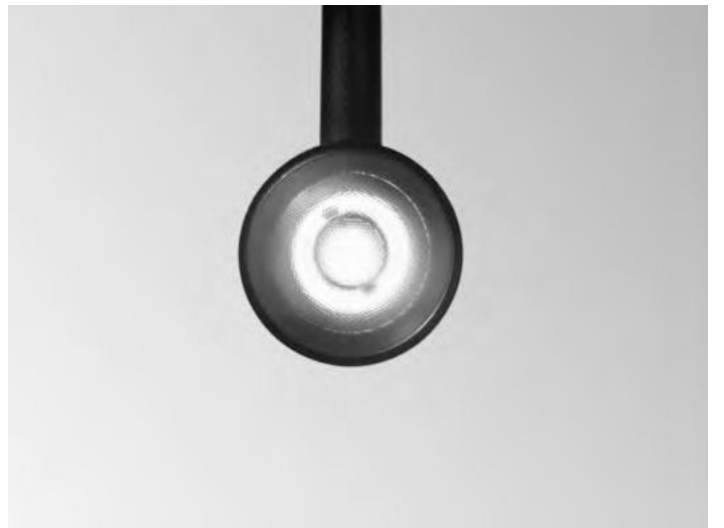
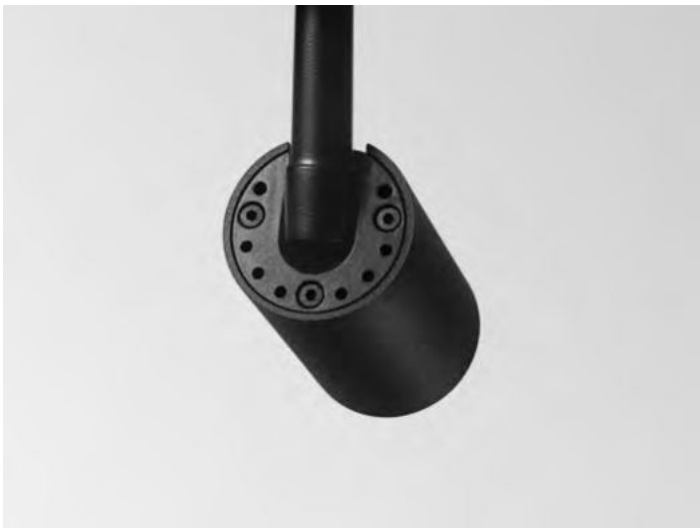
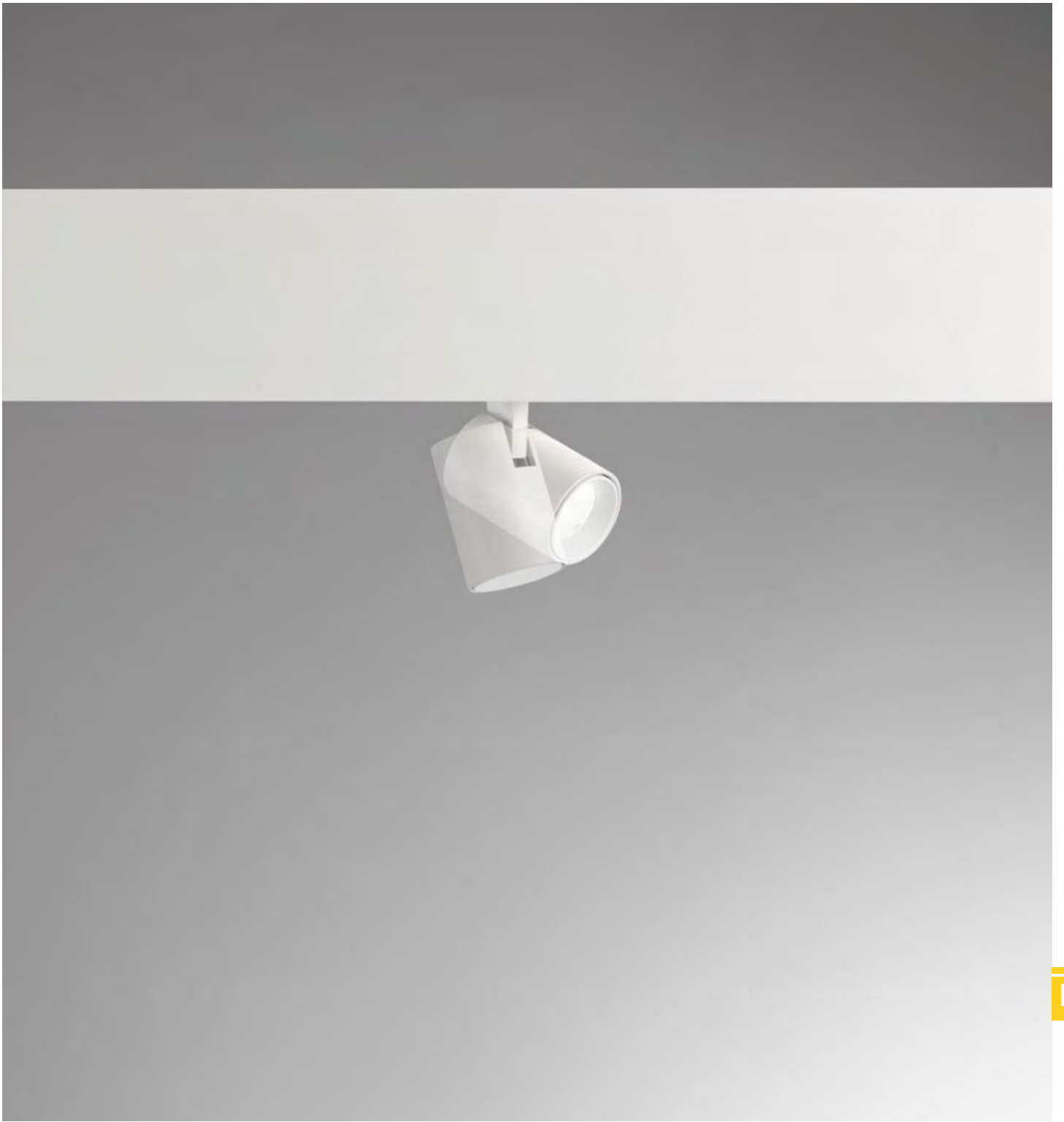

Oxy Track Double

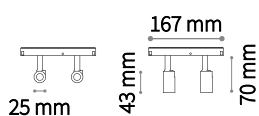

LED COB OSRAM

Potenza	Angolo	Flux	CCT	Finitura	Codice	€
5 W	23°	400 Lm	3000 K	Bianco	248882	160 <small>new</small>
				Nero	224114	160



90° 355° 0,160 Kg/0,0020 m³

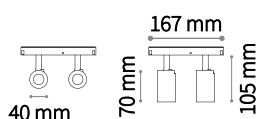

LED COB OSRAM

Potenza	Angolo	Flux	CCT	Finitura	Codice	€
15 W	36°	1200 Lm	3000 K	Bianco	248868	180 <small>new</small>
				Nero	224145	180



90° 355° 0,310 Kg/0,0028 m³

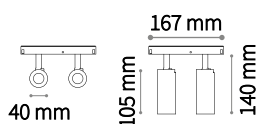

LED COB CITIZEN

Potenza	Angolo	Flux	CCT	Finitura	Codice	€
22 W	34°	1950 Lm	3000 K	Bianco	248875	188 <small>new</small>
				Nero	224176	188



90° 355° 0,380 Kg/0,0023 m³

OPTIONAL Non incluso



	Angolo	Codice	€
Lente 5 W	12°	224121	3
Lente 15 W	20°	224183	4
Lente 22 W	20°	224183	4

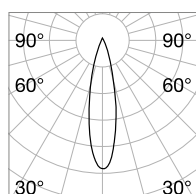

m	lx	øm
1	1522	0,40
2	381	0,80
3	169	1,20
4	95	1,60
5	51	2,01

CRI≥90 5W 23° 400 Lm 3000 K

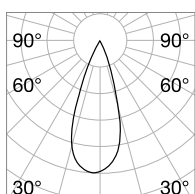

m	lx	øm
1	2802	0,64
2	701	1,28
3	311	1,92
4	175	2,56
5	93	3,20

CRI≥90 15W 36° 1200 Lm 3000 K

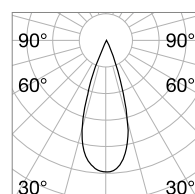

m	lx	øm
1	2846	0,62
2	712	1,24
3	316	1,86
4	178	2,48
5	95	3,10

CRI≥90 22W 34° 1950 Lm 3000 K

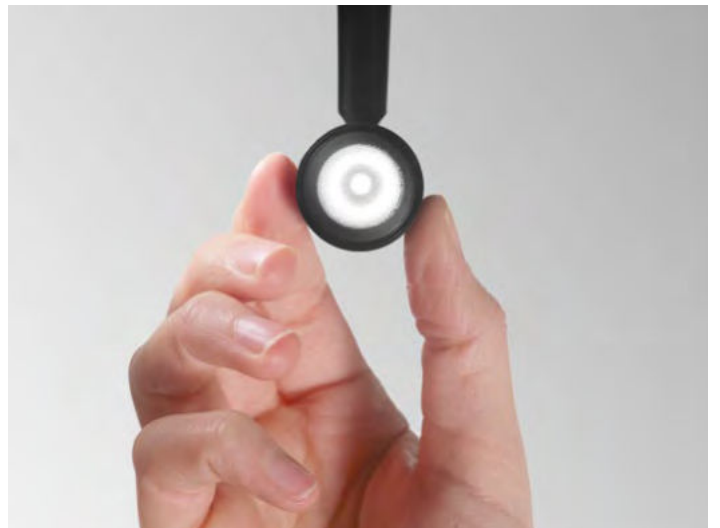

Oxy Accent and Wide

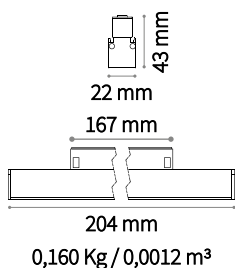

LED COB OSRAM UGR <16

Potenza	Angolo	Flux	CCT	Finitura	Codice	€
8 W	32°	780 Lm	3000 K	Bianco	248691	135 <small>new</small>
				Nero	224084	135

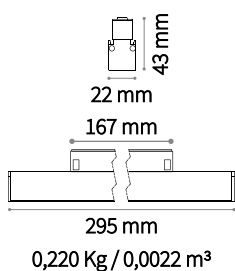

LED COB OSRAM UGR <16

Potenza	Angolo	Flux	CCT	Finitura	Codice	€
15 W	32°	1550 Lm	3000 K	Bianco	248714	160 <small>new</small>
				Nero	224091	160

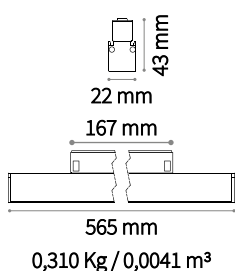

LED SMD BRIDGELUX

Potenza	Angolo	Flux	CCT	Finitura	Codice	€
13 W	115°	1300 Lm	3000 K	Bianco	248936	156 <small>new</small>
				Nero	224053	156

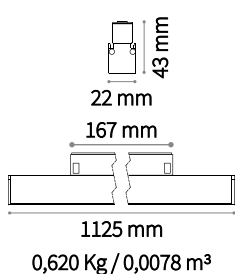

LED SMD BRIDGELUX

Potenza	Angolo	Flux	CCT	Finitura	Codice	€
26 W	115°	2550 Lm	3000 K	Bianco	248929	206 <small>new</small>
				Nero	224060	206

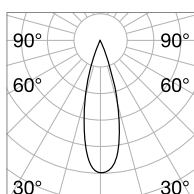

m	lx	øm
1	5076	0,49
2	1569	0,99
3	564	1,48
4	317	1,98
5	169	2,47

CRI≥90 15W 32° 1150 Lm 3000 K

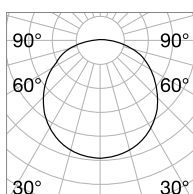

m	lx	øm
1	552	2,99
2	138	5,99
3	61	8,98
4	35	11,98
5	18	14,97

CRI≥90 26W 115° 2550 Lm 3000 K



Oxy Pendant

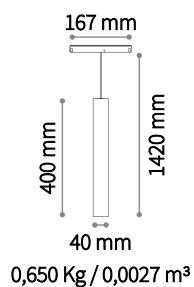

LED COB CITIZEN UGR <13

Potenza	Angolo	Flux	CCT	Finitura	Codice	€
8 W	23°	520 Lm	3000 K	Bianco	248806	194 <i>new</i>
				Nero	224190	194

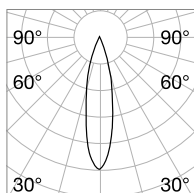

m	lx	ø m
1	1831	0,41
2	458	0,82
3	203	1,24
4	114	1,65
5	61	2,07

CRI ≥ 90 8W 23° 520 Lm 3000 K



Oxy - Profiles



TRACK LOW

Lunghezza	Peso	Volume	Finitura	Codice	€
2000 mm	1,52 Kg	0,0018 m ³	Bianco	248820	170 <i>new</i>
			Nero	224725	170
3000 mm	2,25 Kg	0,0027 m ³	Bianco	248844	250 <i>new</i>
			Nero	224732	250

END CAP LOW Non incluso/Necessario



	Finitura	Codice	€
Senza foro	Bianco	248752	14 <i>new</i>
	Nero	224756	14
Con foro	Bianco	248769	17 <i>new</i>
	Nero	224763	17

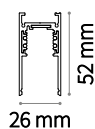

TRACK HIGH

Lunghezza	Peso	Volume	Finitura	Codice	€
2000 mm	1,97 Kg	0,0018 m ³	Bianco	248813	180 <i>new</i>
			Nero	223988	180
3000 mm	2,90 Kg	0,0027 m ³	Bianco	248837	260 <i>new</i>
			Nero	223995	260

END CAP HIGH Non incluso/Necessario



	Finitura	Codice	€
Senza foro	Bianco	248738	14 <i>new</i>
	Nero	224213	14
Con foro	Bianco	248745	17 <i>new</i>
	Nero	224718	17



Oxy - Optional



SUSPENSION KIT Non incluso/Optional - 2 kit x 1000 mm

Rosone	N° Cavi	Lunghezza cavi	Finitura	Codice	€
No	1	5000 mm	Grigio	224022	41



ENERGY SUPPLY Non incluso/Necessario

Finitura	Codice	€
Bianco	248776	30 <i>new</i>
Nero	224237	30



LINEAR CONNECTOR Non incluso/Optional

Finitura	Codice	€
Bianco	254968	29 <i>new</i>
Nero	254951	29



DRIVER MEANWELL ON/OFF Non incluso/Necessario

Potenza	Output	Classe	Misura	Codice	€
60 W	48 Vdc	⊕	171x62x37 mm	223155	112
90 W	48 Vdc	⊕	220x68x37 mm	223162	150
150 W	48 Vdc	⊕	228x68x37 mm	223179	166
240 W	48 Vdc	⊕	244x68x39 mm	224275	213

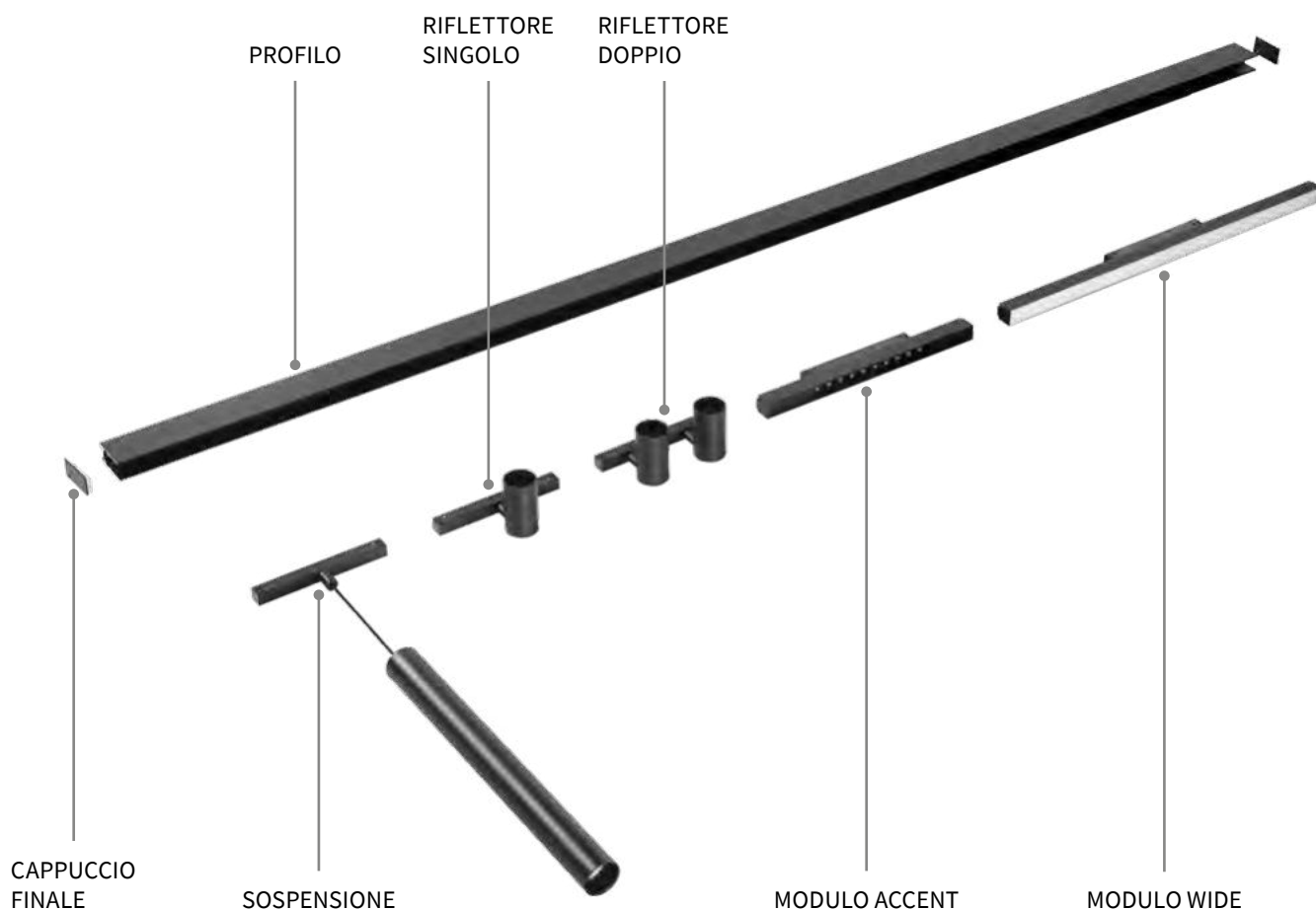

Fluo **new**

Sistema lineare di lampade con scocca in alluminio estruso di sezione larga 50 mm e alta 80 mm. Moduli disponibili in due lunghezze: 1200 mm e 1800 mm, componibili tra loro a seconda della disposizione desiderata. Possibilità di assemblaggio di tre diversi moduli sorgente: il modulo WIDE diffondente, il modulo BI-EMISSION con componente di luce per l'illuminazione indiretta e il modulo ACCENT con controllo dell'UGR inferiore a 13; LED integrati, possibilità di temperatura di colore di 3000 K o di 4000 K; binning iniziale ≤ 3 -Step MacAdam; protezione IP 20, classe isolamento I. Il sistema è disponibile nei colori alluminio anodizzato, bianco, nero e nelle possibili modalità d'installazione a plafone, a sospensione oppure a incasso a filo in soffitti di cartongesso. Driver incluso, integrato nel corpo illuminante, disponibile in versione dimmerabile sia DALI che 1-10V. Sistema adatto per ambienti dove richiesta un'illuminazione professionale dal design minimale, ad esempio UFFICI e spazi COMMERCIALI.

Sorgente	LED COB / SMD
Driver incluso	On/Off
Driver disponibili	1-10V / DALI
MacAdam	SDCM 3
Angolo	Accent / Wide / Bi-Emission
CCT	3000 K / 4000 K
CRI	≥ 83
UGR	< 13 (Accent)
Durata LED	30.000 h
Classe isolamento	I
IP	20
Materiale	Alluminio
Garanzia	5 anni



Recessed

Ceiling

Pendant





Fluo Accent

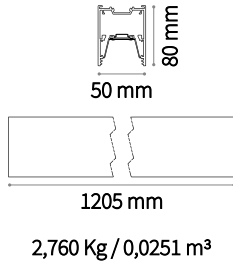

LED COB CREE Driver TRIDONIC ON/OFF incluso - UGR <13

Potenza	Angolo	Flux	CCT	Finitura	Codice	€
30 W	30°	3000 Lm	3000 K	Alluminio	192635	299
				Bianco	192611	309
				Nero	192581	309
3300 Lm	4000 K		Alluminio	Bianco	192574	299
				Bianco	192543	309
				Nero	192529	309

DIMMABLE DRIVER Non incluso/Optional

	Potenza	Output	Misura	Codice	€
1-10V	39 W	700 mA	280x30x21 mm	216416	96
DALI	38 W	700 mA	280x30x21 mm	216270	107

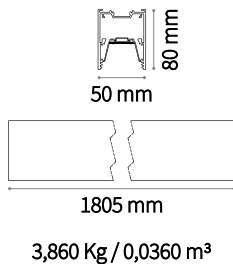

LED COB CREE Driver TRIDONIC ON/OFF incluso - UGR <13

Potenza	Angolo	Flux	CCT	Finitura	Codice	€
30 W	30°	3000 Lm	3000 K	Alluminio	192512	340
				Bianco	192499	357
				Nero	192475	357
3300 Lm	4000 K		Alluminio	Bianco	192451	340
				Bianco	192444	357
				Nero	192420	357

DIMMABLE DRIVER Non incluso/Optional

	Potenza	Output	Misura	Codice	€
1-10V	39 W	700 mA	280x30x21 mm	216416	96
DALI	38 W	700 mA	280x30x21 mm	216270	107

MOUNTING KIT Non incluso/Necessario - Pagina 615

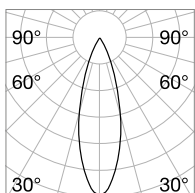

m	lx	ø m
1	8264	0,48
2	2066	0,96
3	918	1,45
4	516	1,93
5	330	2,42

CRI≥83 30W 30° 3000 Lm 3000 K

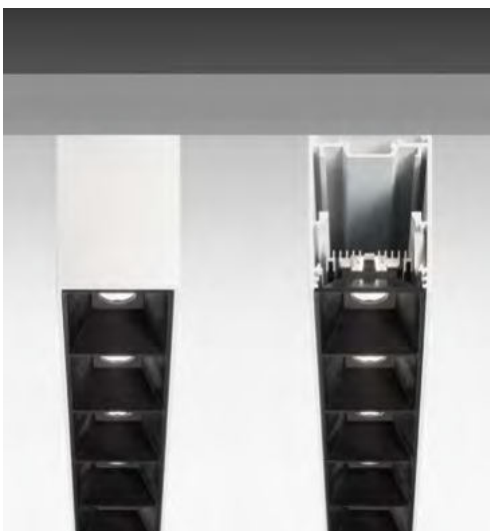

Fluo Accent 1200

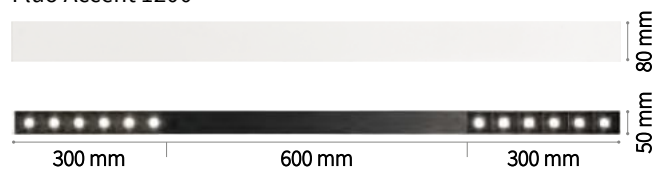

Fluo Accent 1800

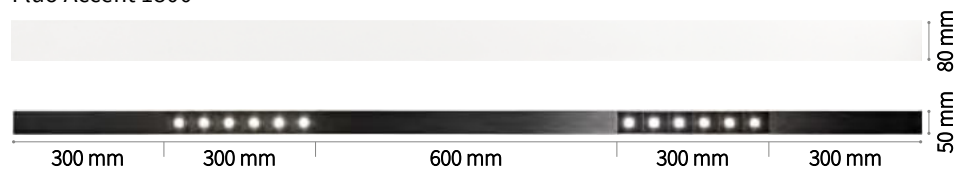

Lo spessore del singolo cappuccio finale è di 2,5 mm.

Fluo Wide

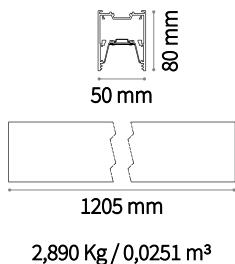

LED SMD SAMSUNG Driver TRIDONIC ON/OFF incluso

Potenza	Angolo	Flux	CCT	Finitura	Codice	€
27 W	105°	3450 Lm	3000 K	Alluminio	191447	270
				Bianco	192437	278
				Nero	191997	278
3650 Lm	4000 K	Alluminio	192468	270		
		Bianco	192482	278		
		Nero	192505	278		

DIMMABLE DRIVER Non incluso/Optional

	Potenza	Output	Misura	Codice	€
1-10V	28 W	500 mA	280x30x21 mm	216423	96
DALI	27 W	500 mA	280x30x21 mm	216287	107

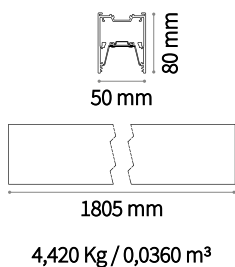

LED SMD SAMSUNG Driver TRIDONIC ON/OFF incluso

Potenza	Angolo	Flux	CCT	Finitura	Codice	€
36 W	105°	4750 Lm	3000 K	Alluminio	192536	360
				Bianco	192550	372
				Nero	192567	372
5050 Lm	4000 K	Alluminio	192598	360		
		Bianco	192604	372		
		Nero	192628	372		

DIMMABLE DRIVER Non incluso/Optional

	Potenza	Output	Misura	Codice	€
1-10V	39 W	700 mA	280x30x21 mm	216416	96
DALI	38 W	700 mA	280x30x21 mm	216270	107

MOUNTING KIT Non incluso/Necessario - Pagina 615

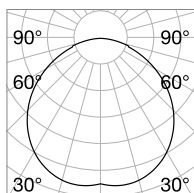

m	lx	øm
1	1042	2,50
2	260	5,00
3	115	7,50
4	65	10,00
5	41	12,50

CRI≥83 27W 105° 3450 Lm 3000 K



Fluo Wide 1200

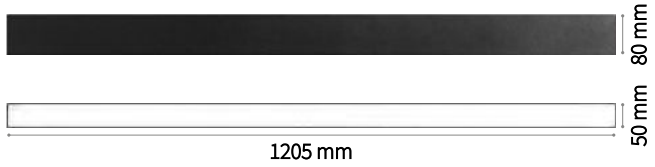

Fluo Wide 1800

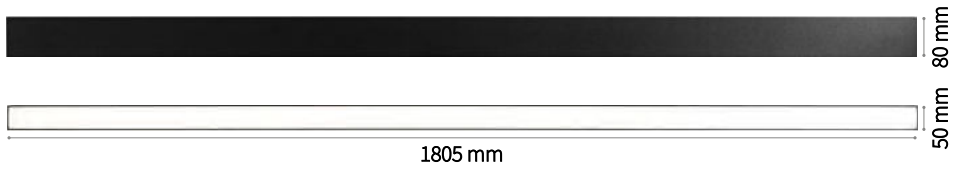

Lo spessore del singolo cappuccio finale è di 2,5 mm.

Fluo Bi-Emission

LUCE INDIRETTA INCLUSA* (•)

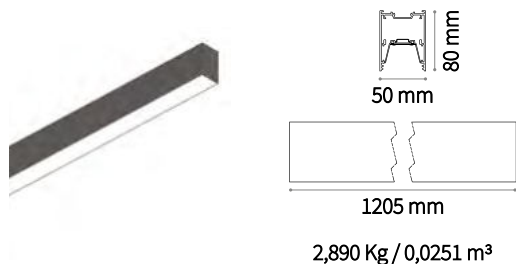

LED SMD SAMSUNG Driver TRIDONIC ON/OFF incluso

Potenza	Angolo	Flux	CCT	Finitura	Codice	€
27 W	105°	3450 Lm	3000 K	Alluminio	192659	357
13 W •	105° •	2200 Lm •		Bianco	192666	368
				Nero	192710	368
		3650 Lm	4000 K	Alluminio	192734	357
		2350 Lm •		Bianco	192741	368
				Nero	192758	368

DIMMABLE DRIVER Non incluso/Optional

	Potenza	Output	Misura	Codice	€
1-10V	28 W	500 mA	280x30x21 mm	216423	96
1-10V •	17 W	300 mA	280x30x21 mm	216447	96
DALI	27 W	500 mA	280x30x21 mm	216287	107
DALI •	14 W	250 mA	280x30x21 mm	216300	107

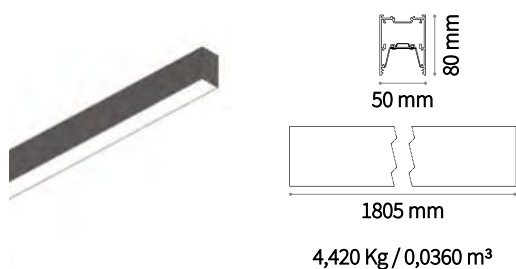

LED SMD SAMSUNG Driver TRIDONIC ON/OFF incluso

Potenza	Angolo	Flux	CCT	Finitura	Codice	€
36 W	105°	4750 Lm	3000 K	Alluminio	192727	474
18 W •	105° •	2950 Lm •		Bianco	192703	490
				Nero	192697	490
		5050 Lm	4000 K	Alluminio	192680	474
		3100 Lm •		Bianco	192673	490
				Nero	192642	490

DIMMABLE DRIVER Non incluso/Optional

	Potenza	Output	Misura	Codice	€
1-10V	39 W	700 mA	280x30x21 mm	216416	96
1-10V •	20 W	350 mA	280x30x21 mm	216430	96
DALI	38 W	700 mA	280x30x21 mm	216270	107
DALI •	19 W	350 mA	280x30x21 mm	216294	107

MOUNTING KIT Non incluso/Necessario - Pagina 615

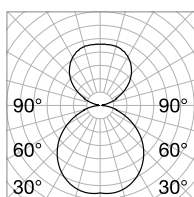

m	lx	øm
1	512	2,10
2	128	4,21
3	56	6,32
4	32	8,43
5	20	10,54

CRI≥83 27+13W 105°+105° 3450+2200 Lm 3000 K

*Accensione separata.



Fluo Bi-Emission 1200

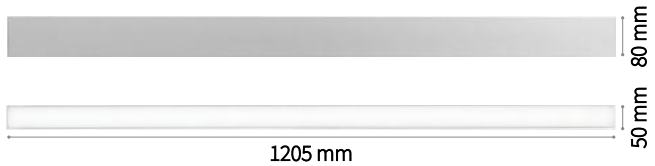

Fluo Bi-Emission 1800

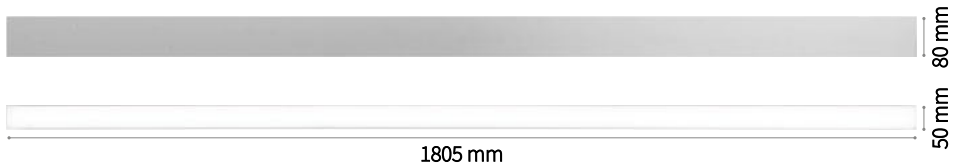

Lo spessore del singolo cappuccio finale è di 2,5 mm.

Fluo - Optional

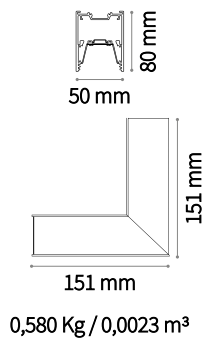

CORNER Non incluso/Optional - Driver ON/OFF incluso

Potenza	Angolo	Flux	CCT	Finitura	Codice	€
7,5 W	105°	810 Lm	3000 K	Alluminio	191416	82
				Bianco	191423	85
				Nero	191430	85
		850 Lm	4000 K	Alluminio	191980	82
				Bianco	191454	85
				Nero	191461	85

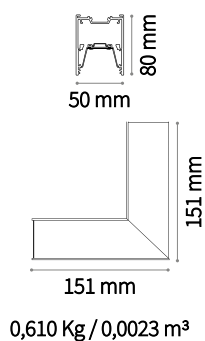

BLINDED CORNER Non incluso/Optional

Finitura	Codice	€
Alluminio	191478	46
Bianco	191485	48
Nero	191492	48

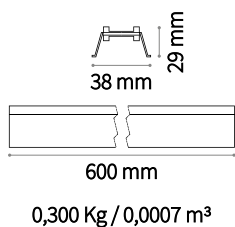

STRIP LED MODULE Accessori per personalizzazione

Potenza	Angolo	Flux	CCT	Voltaggio	Codice	€
8 W	105°	1100 Lm	3000 K	12 Vdc	198668	75
		1150 Lm	4000 K	12 Vdc	198675	75
13 W	105°	1650 Lm	3000 K	24 Vdc	198699	75
			3000 K	48 Vdc	198705	75
		1750 Lm	4000 K	24 Vdc	198682	75
			4000 K	48 Vdc	198712	75

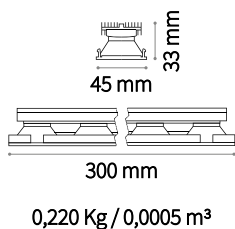

ACCENT MODULE Accessori per personalizzazione

Potenza	Angolo	Flux	CCT	Finitura	Codice	€
13 W	30°	1500 Lm	3000 K	Nero	199023	96
		1650 Lm	4000 K	Nero	199030	96

Fluo - Kit and Optional

MOUNTING KIT Non incluso/Necessario - 1 kit x 1500 mm



	Rosone	N° Cavi	Lunghezza cavi	Finitura	Codice	€
Kit Sospensione	Sì	2	2000 mm	Bianco	191591	27
		2		Nero	191164	27
	Sì	2	5000 mm	Bianco	215907	37
		2		Nero	215891	37
	No	1	2000 mm		220826	11
	No	1	5000 mm		243665	15 <small>new</small>



	Finitura	Codice	€
Kit Incasso	Grigio	191188	32



	Finitura	Codice	€
Kit Soffitto	Grigio	191171	18

COVER Non incluso/Optional



	Materiale	Lunghezza	Colore	Codice	€
Opale	PMMA	600 mm	Bianco	191645	8
		1200 mm	Bianco	191652	16
		1800 mm	Bianco	191669	23
Non luminosa	Alluminio	150 mm	Nero	191355	6
		300 mm	Nero	191362	8
		600 mm	Nero	191379	15



STRUCTURE CONNECTOR Non incluso/Optional

Codice	€
191508	6

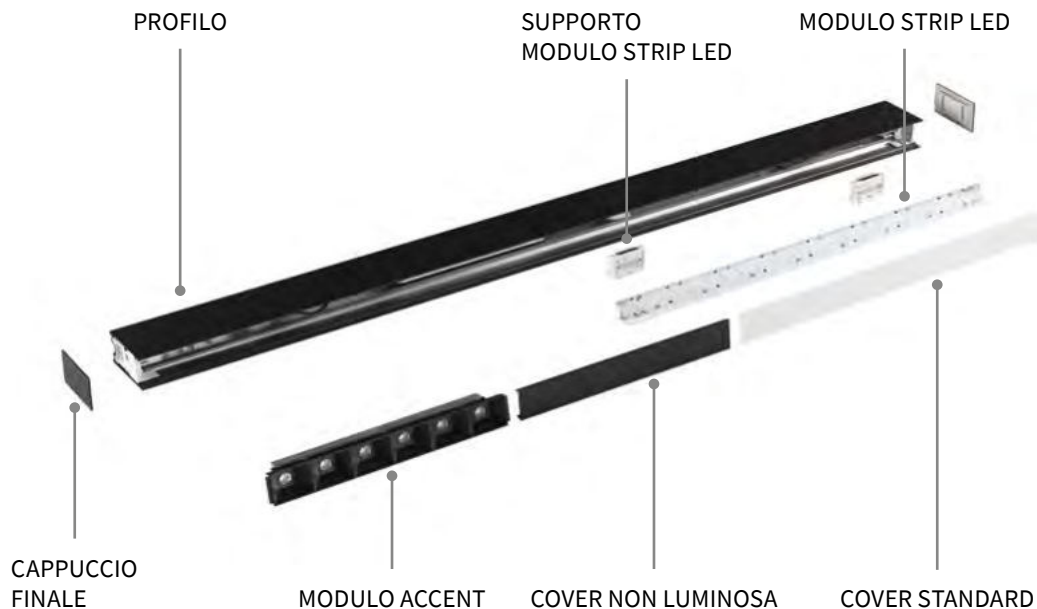

Draft

LUCE INDIRECTA INCLUSA (•)

Sorgente	LED SMD
Driver incluso	On/Off / 1-10V
Driver disponibili	No
MacAdam	SDCM 3
Angolo	55°+90°
CCT	3000 K / 4000 K
CRI	≥80

UGR	<13
Durata LED	50.000 h
Classe isolamento	I
IP	20
Materiale	Alluminio
Garanzia	5 anni

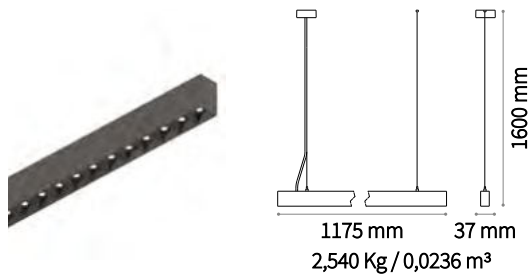

LED SMD SAMSUNG Driver ON/OFF incluso

Potenza	Angolo	Flux	CCT	Finitura	Codice	€
23,5 W	55°	2700 Lm	3000 K	Bianco	223780	370
23,5 W •	90° •	3100 Lm •		Nero	223773	370
		2850 Lm	4000 K	Bianco	223803	370
		3250 Lm •		Nero	223797	370

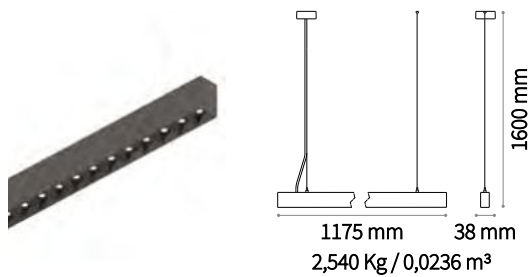

LED SMD SAMSUNG Driver 1-10V incluso

Potenza	Angolo	Flux	CCT	Finitura	Codice	€
23,5 W	55°	2700 Lm	3000 K	Bianco	215440	380
23,5 W •	90° •	3100 Lm •		Nero	222776	380
		2850 Lm	4000 K	Bianco	222790	380
		3250 Lm •		Nero	222783	380



STRUCTURE CONNECTOR Non incluso/Optional

Codice	€
222813	8

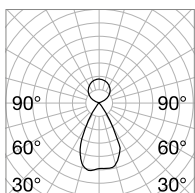

m	lx	ø m
1	2787	1,00
2	696	2,01
3	309	3,02
4	174	4,03
5	92	5,04

CRI≥80 23,5+23,5W 55°+90° 2700+3100 Lm 3000 K

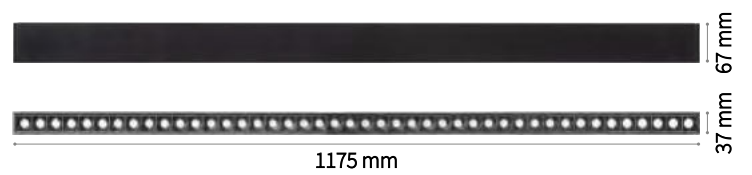
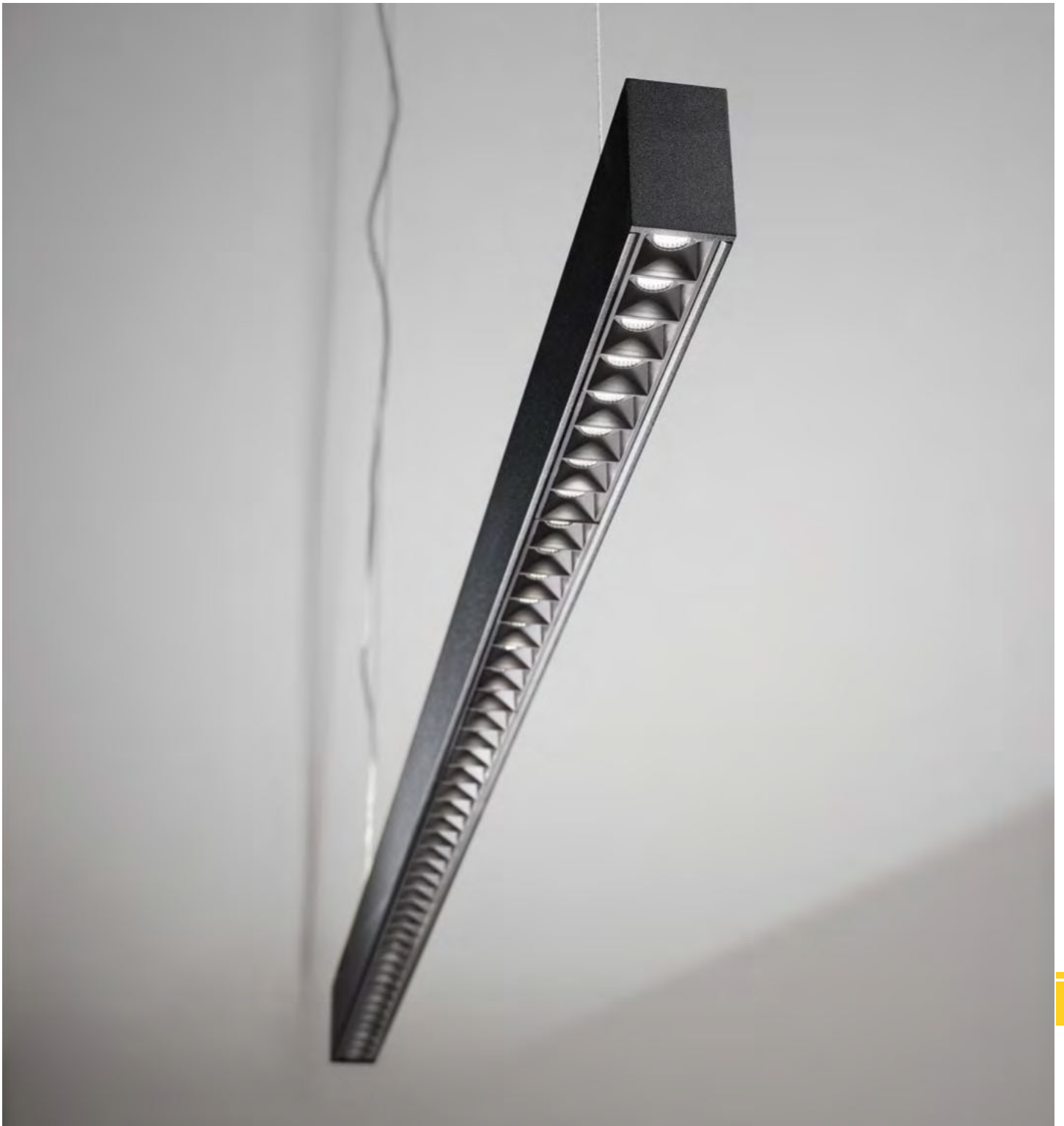

Lo spessore del singolo cappuccio finale è di 2,5 mm.

Sorgente	LED SMD
Driver incluso	1-10V
Driver disponibili	No
CCT	3000 K
CRI	≥80

Durata LED	50.000 h
Classe isolamento	I
IP	20
Materiale	Alluminio
Garanzia	5 anni

WALL - LED SMD Driver 1-10V incluso

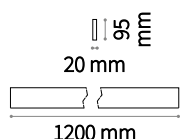

1,250 Kg / 0,0112 m³

Potenza	Angolo	Flux	CCT	Finitura	Codice	€
34 W	104°	1950 Lm	3000 K	Bianco	233840	150 new
34 W •	104° •	1900 Lm •		Nero	242019	150 new

STRUCTURE CONNECTOR Non incluso/Optional



Codice	€
233666	5 new

PENDANT - LED SMD Driver 1-10V incluso

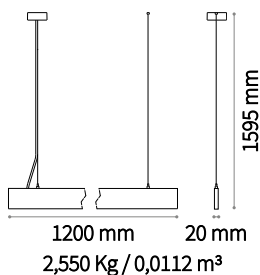

2,550 Kg / 0,0112 m³

Potenza	Angolo	Flux	CCT	Finitura	Codice	€
34 W	104°	1950 Lm	3000 K	Bianco	241968	165 new
34 W •	104° •	1900 Lm •		Nero	241975	165 new

STRUCTURE CONNECTOR Non incluso/Optional



Codice	€
241982	5 new

CORNER Non incluso/Optional

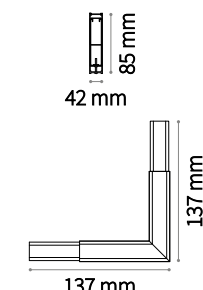

0,260 Kg / 0,0003 m³

Potenza	Angolo	Flux	CCT	Finitura	Codice	€
3 W	104°	270 Lm	3000 K	Bianco	241999	35 new
				Nero	242002	35 new

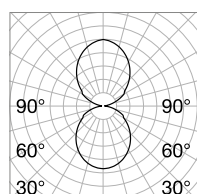

m	lx	ø m
1	572	2,56
2	143	5,12
3	64	7,68
4	36	10,24
5	23	12,80

CRI≥80 34W 104°+104° 1950+1900 Lm 3000 K

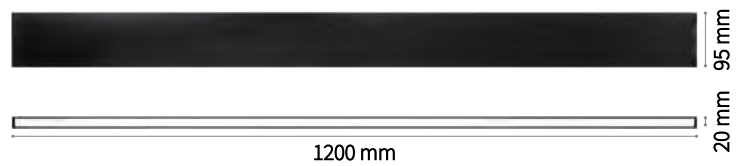

Slot

Profilo in alluminio estruso con superficie verniciata a polveri bianca e cover opalina in PMMA. Barre a diverse sezioni in opzione incasso nella versione RECESSED per soffitti in cartongesso e nella versione SURFACE per installazione a parete o soffitto.

I moduli lineari sono disponibili nelle lunghezze di 1000, 2000 e 3000 mm, sono componibili a seconda del disegno desiderato e sezionabili a misura.

Led e driver da abbinare per una corretta installazione. Sorgente luminosa disponibile con temperatura di colore di 2700 K, 3000 K, 4000 K; CRI ≥ 80 , ≥ 85 e ≥ 90 ; disponibile con protezione IP20 e IP65.

Versione	Recessed / Surface
Lunghezza	1000 / 2000 / 3000 mm
Larghezza	11 / 20 mm
Materiale	Alluminio





Slot Recessed

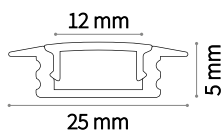

PROFILE 12 mm Kit per montaggio incluso

Lunghezza	Peso	Volume	Finitura	Codice	€
1000 mm	0,15 Kg	0,0010 m ³	Bianco	124155	11
2000 mm	0,35 Kg	0,0020 m ³	Bianco	203102	20
3000 mm	0,54 Kg	0,0030 m ³	Bianco	204611	30

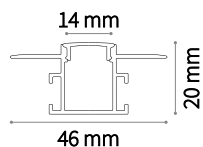

PROFILE 14 mm

Lunghezza	Peso	Volume	Finitura	Codice	€
2000 mm	0,65 Kg	0,0020 m ³	Bianco	223704	46
3000 mm	0,90 Kg	0,0030 m ³	Bianco	223711	73

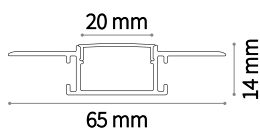

PROFILE 20 mm

Lunghezza	Peso	Volume	Finitura	Codice	€
2000 mm	0,60 Kg	0,0020 m ³	Bianco	223728	54
3000 mm	0,90 Kg	0,0030 m ³	Bianco	223735	80

REQUIRED Non incluso



	Finitura	Codice	€
Kit Lineare	Grigio	223766	3



	Finitura	Codice	€
Kit Destra - Sinistra	Grigio	223759	3



	Finitura	Codice	€
Kit Verticale - Orizzontale	Grigio	223742	3

STRIP LED AND DRIVER Non incluso/Necessario - Pagina 858

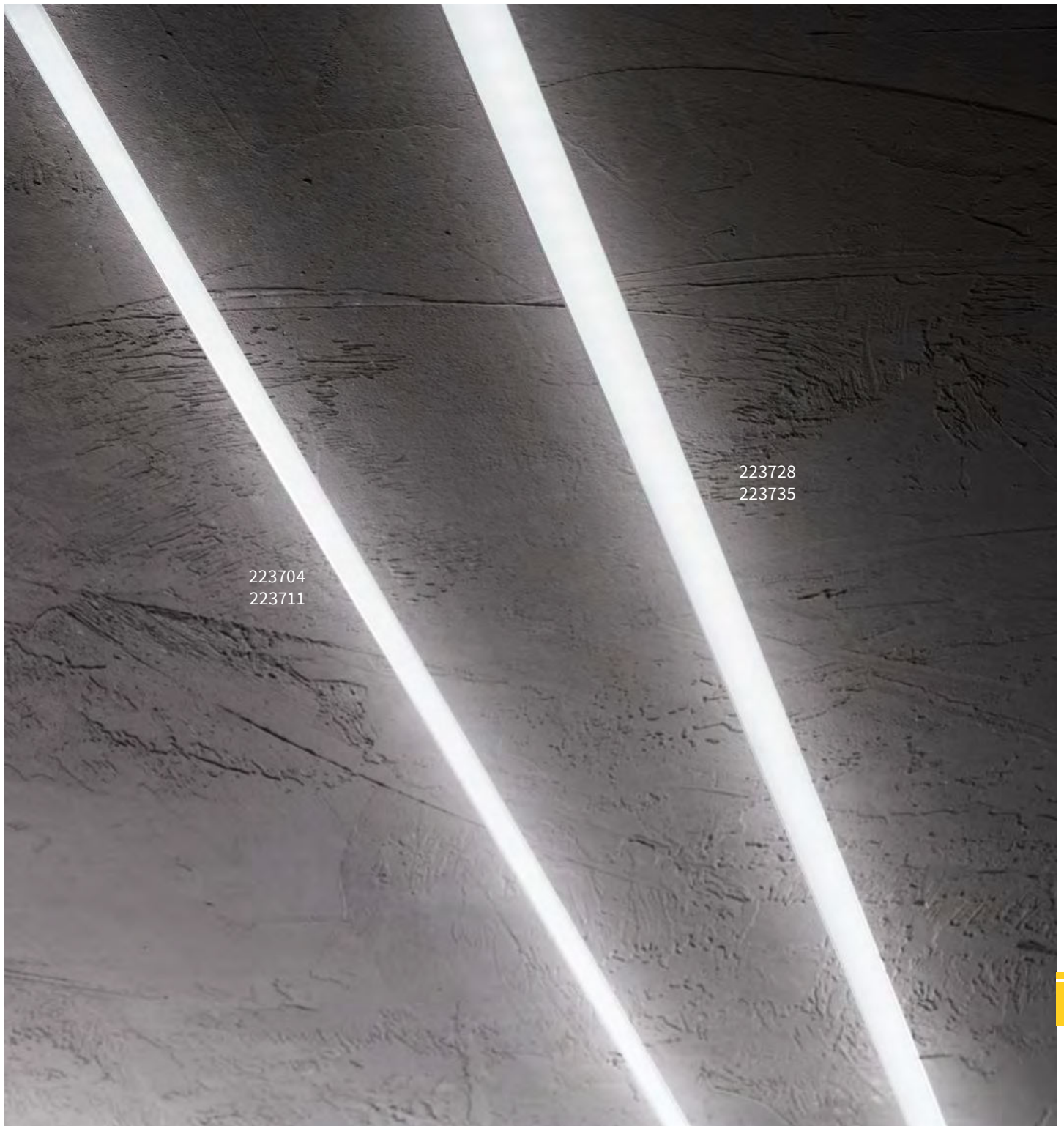

223704
223711

223728
223735

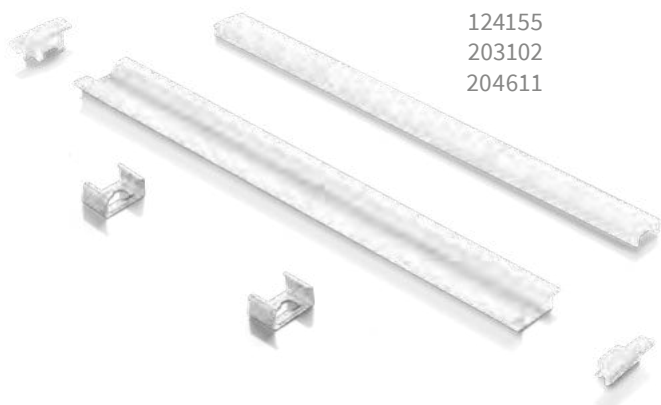

124155
203102
204611



223728
223735

Kit per montaggio profilo 12 mm.

Slot Surface

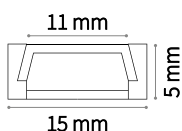

FLAT PROFILE Kit per montaggio incluso

Lunghezza	Peso	Volume	Finitura	Codice	€
1000 mm	0,15 Kg	0,0010 m ³	Bianco	124131	9
	0,15 Kg	0,0010 m ³	Alluminio	124124	8
2000 mm	0,20 Kg	0,0020 m ³	Bianco	203089	16
	0,20 Kg	0,0020 m ³	Alluminio	203072	15
3000 mm	0,34 Kg	0,0030 m ³	Bianco	204598	23
	0,34 Kg	0,0030 m ³	Alluminio	204581	21

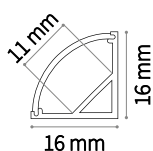

ANGULAR PROFILE Kit per montaggio incluso

Lunghezza	Peso	Volume	Finitura	Codice	€
1000 mm	0,15 Kg	0,0010 m ³	Bianco	126548	11
	0,15 Kg	0,0010 m ³	Alluminio	126531	10
2000 mm	0,30 Kg	0,0020 m ³	Bianco	203126	20
	0,30 Kg	0,0020 m ³	Alluminio	203119	19
3000 mm	0,44 Kg	0,0030 m ³	Bianco	204635	30
	0,44 Kg	0,0030 m ³	Alluminio	204628	28

STRIP LED AND DRIVER Non incluso/Necessario - Pagina 858



Kit per montaggio profilo a vista.



Kit per montaggio profilo angolare.

Tecnico Tracklights



Quick 628



Smile 636



Fox 644



Glim 646



Glim 646



Slide 647



Lunare 648



Mouse 648



Spot 648



Look 650



Sky 650



Frida 651



Mr Jack 652



Metro 652



Moby 653



Link 654



Quick

Pag 628

Quick **new**

Proiettore cilindrico in alluminio estruso adatto per installazione su binario trifase. Verniciatura a polveri bianco o nero, testata girevole 355° e orientabile 90°. Il driver di alimentazione incluso, trova alloggiamento nel corpo cilindrico del proiettore stesso. Disponibile anche in versione dimmerabile 1-10 V o DALI. Sorgente luminosa con tecnologia COB LED integrato per la massima efficienza, disponibile con temperatura di colore di 3000 K o 4000 K; LED efficienza energetica elevata resa cromatica fino a CRI ≥ 90 ; binning iniziale ≤ 3 -Step MacAdam; ottica a fascio simmetrico con tre diversi angoli di emissione e controllo dell'abbagliamento (UGR < 19). Montaggio e smontaggio senza utensili. Protezione IP20; classe isolamento I. Ideale per l'illuminazione di grandi ambienti dove viene richiesta ampia flessibilità e resa cromatica, ad esempio spazi MUSEALI, COMMERCIALI e RETAIL.

Sorgente	LED COB
Potenza	15W / 21W / 28W
Driver incluso	On/Off / 1-10V / DALI
Driver disponibili	No
Binario	Trifase (standard Eutrac)
MacAdam	SDCM 3
CCT	3000 K / 4000 K
CRI	≥ 80 / ≥ 90
Durata LED	50.000h
Classe isolamento	I
IP	20
Materiale	Alluminio
Garanzia	5 anni

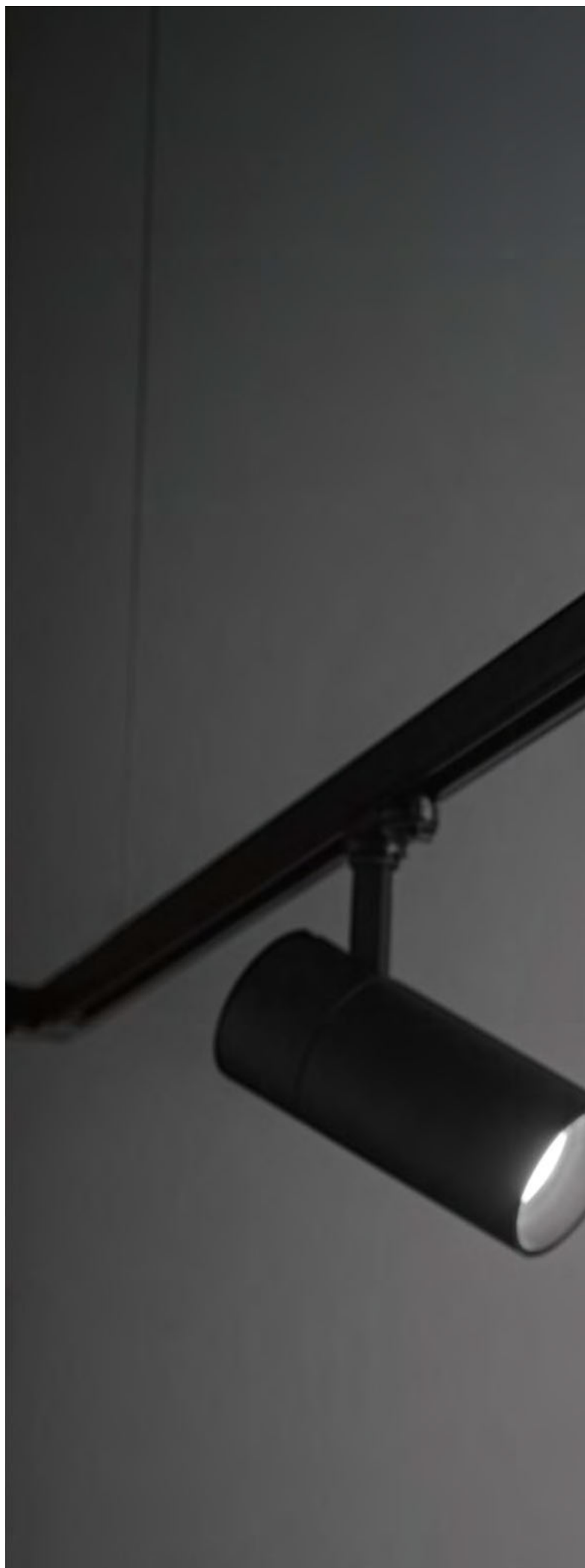



Quick 15W

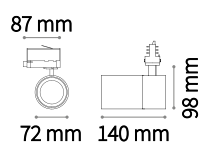

0,760 Kg / 0,0038 m³

LED COB CITIZEN

CRI ≥80

Potenza	Angolo	Driver	Flux	CCT	Finitura	Codice	€	
15 W	30°	On-Off	1900 Lm	3000 K	Bianco	222509	136	
					Nero	222523	136	
		1-10V	2050 Lm	4000 K	Bianco	222530	136	
					Nero	222547	136	
			DALI	1900 Lm	3000 K	Bianco	249643	190 <i>new</i>
						Nero	247861	190 <i>new</i>
					Bianco	249681	245 <i>new</i>	
					Nero	246437	245 <i>new</i>	

CRI ≥90

Potenza	Angolo	Driver	Flux	CCT	Finitura	Codice	€
15 W	30°	On-Off	1650 Lm	3000 K	Bianco	222554	136
					Nero	222561	136
			1800 Lm	4000 K	Bianco	222578	136
					Nero	222585	136

OPTIONAL Non incluso



Finitura	Codice	€
Filtro Honeycomb	222608	7



Angolo	Codice	€
Lente* 15°	222592	7
45°	253558	7



Finitura	Codice	€
Connessione singola Bianco	170145	21
Nero	170152	21

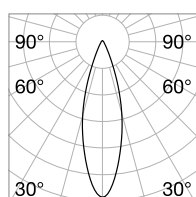

m	lx	Øm
1	3451	0,51
2	862	1,02
3	383	1,53
4	215	2,04
5	138	2,55

CRI≥80 15W 30° 1900 Lm 3000 K

*La lente opzionale verrà montata nel prodotto al posto della lente standard inclusa.



Quick 21W

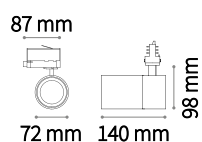

0,760 Kg / 0,0038 m³

LED COB CITIZEN

CRI ≥80

Potenza	Angolo	Driver	Flux	CCT	Finitura	Codice	€
21 W	30°	On-Off	2900 Lm	3000 K	Bianco	247946	142 <i>new</i>
					Nero	247939	142 <i>new</i>
		1-10V	2900 Lm	3000 K	Bianco	247960	142 <i>new</i>
					Nero	247953	142 <i>new</i>
		DALI	2900 Lm	3000 K	Bianco	249650	194 <i>new</i>
					Nero	247878	194 <i>new</i>
			Bianco	249698	248 <i>new</i>		
			Nero	246444	248 <i>new</i>		

CRI ≥90

Potenza	Angolo	Driver	Flux	CCT	Finitura	Codice	€
21 W	30°	On-Off	2400 Lm	3000 K	Bianco	247977	142 <i>new</i>
					Nero	225364	142 <i>new</i>
			2550 Lm	4000 K	Bianco	247991	142 <i>new</i>
					Nero	247984	142 <i>new</i>

OPTIONAL Non incluso



Finitura	Codice	€
Filtro Honeycomb	222608	7



Angolo	Codice	€
Lente* 15°	222592	7
45°	253558	7 <i>new</i>



Finitura	Codice	€
Connessione singola Bianco	170145	21
Nero	170152	21

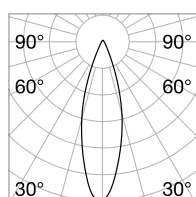

m	lx	Øm
1	6576	0,57
2	1644	1,14
3	731	1,71
4	411	2,28
5	263	2,85

CRI≥80 21W 30° 2900 Lm 3000 K

*La lente opzionale verrà montata nel prodotto al posto della lente standard inclusa.



Quick 28W

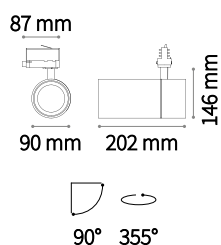

1,200 Kg / 0,0063 m³

LED COB CITIZEN

CRI ≥80

Potenza	Angolo	Driver	Flux	CCT	Finitura	Codice	€
28 W	30°	On-Off	3850 Lm	3000 K	Bianco	222615	168
					Nero	222622	168
			4100 Lm	4000 K	Bianco	222639	168
					Nero	222646	168
		1-10V	3850 Lm	3000 K	Bianco	249674	229 <i>new</i>
					Nero	247885	229 <i>new</i>
		DALI	3850 Lm	3000 K	Bianco	249704	262 <i>new</i>
					Nero	246413	262 <i>new</i>

CRI ≥90

Potenza	Angolo	Driver	Flux	CCT	Finitura	Codice	€
28 W	30°	On-Off	3350 Lm	3000 K	Bianco	222653	168
					Nero	222660	168
			3600 Lm	4000 K	Bianco	222677	168
					Nero	222684	168

OPTIONAL Non incluso



Finitura	Codice	€
Filtro Honeycomb	222714	8



Angolo	Codice	€
Lente* 18°	222691	8
45°	222707	8



Finitura	Codice	€
Connessione singola Bianco	170145	21
Nero	170152	21

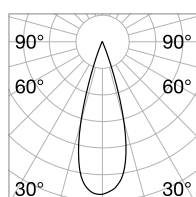

m	lx	Øm
1	8760	0,55
2	2190	1,11
3	973	1,67
4	547	2,22
5	350	2,78

CRI≥80 28W 30° 3850 Lm 3000 K

* La lente opzionale verrà montata nel prodotto al posto della lente standard inclusa.



Smile

Proiettore cilindrico in alluminio (estrusione + lavorazione CNC + forgiatura) adatto per installazione su binario trifase. Verniciatura a polveri in bianco o nero, testata girevole 350° e orient. 90°; il driver di alimentazione è incluso e trova alloggiamento nel corpo cilindrico del proiettore stesso.

Sorgente luminosa con tecnologia COB LED integrato, disponibile con una temperatura di colore di 3000 K o 4000K e con indice di resa cromatica fino a 90; binning iniziale ≤ 4 -Step MacAdam; min. 80% di flusso luminoso rimanente dopo 50.000 h di durata; ottica a fascio simmetrico con tre diversi angoli di emissione e controllo dell'abbagliamento (UGR <19). Montaggio e smontaggio senza utensili.

Protezione IP20; classe isolamento II.

Ideale per l'illuminazione di grandi ambienti dove viene richiesta ampia flessibilità e resa cromatica, ad esempio spazi MUSEALI, COMMERCIALI e RETAIL.

Sorgente	LED COB
Potenza	15W / 20W / 30W
Driver incluso	On/Off
Driver disponibili	No
Binario	Trifase (standard Eutrac)
MacAdam	SDCM ≤ 4
CCT	3000 K / 4000 K
CRI	≥ 82 / ≥ 92
Durata LED	50.000h
Classe isolamento	II
IP	20
Materiale	Alluminio
Garanzia	5 anni





Smile 15W

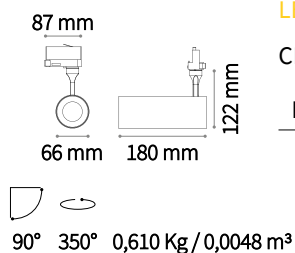

LED COB PHILIPS Driver TRIDONIC ON/OFF incluso

CRI ≥82

Potenza	Angolo	Flux	CCT	Finitura	Codice	€
15 W	24°	1600 Lm	3000 K	Bianco	189574	113
				Nero	189581	113
15 W	36°	1700 Lm	4000 K	Bianco	189611	113
				Nero	189628	113
		1600 Lm	3000 K	Bianco	189758	113
				Nero	189765	113
15 W	50°	1700 Lm	4000 K	Bianco	189796	113
				Nero	189802	113
		1600 Lm	3000 K	Bianco	189932	113
				Nero	189949	113
15 W	36°	1700 Lm	4000 K	Bianco	189956	113
				Nero	189963	113

90° 350° 0,610 Kg / 0,0048 m³

CRI ≥92

Potenza	Angolo	Flux	CCT	Finitura	Codice	€
15 W	24°	1200 Lm	3000 K	Bianco	189598	113
				Nero	189604	113
15 W	36°	1200 Lm	3000 K	Bianco	189772	113
				Nero	189789	113
15 W	50°	1200 Lm	3000 K	Bianco	189970	113
				Nero	189987	113

OPTIONAL Non incluso



Finitura	Codice	€
Filtro Honeycomb	189536	4



Finitura	Codice	€
Filtro Ellittico	189543	5



Finitura	Codice	€
Anello Bianco	189505	11



Finitura	Codice	€
Connessione singola Bianco	170145	21
Connessione singola Nero	170152	21

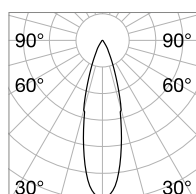

m	lx	øm
1	4362	0,47
2	1090	0,94
3	484	1,41
4	272	1,88
5	174	2,35

CRI≥82 15W 24° 1600 Lm 3000 K

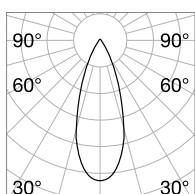

m	lx	øm
1	2923	0,64
2	730	1,29
3	324	1,94
4	182	2,58
5	116	3,23

CRI≥82 15W 36° 1600 Lm 3000 K

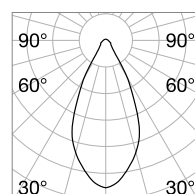

m	lx	øm
1	1611	0,89
2	402	1,79
3	179	2,69
4	100	3,59
5	64	4,49

CRI≥82 15W 50° 1600 Lm 3000 K



Smile 20W

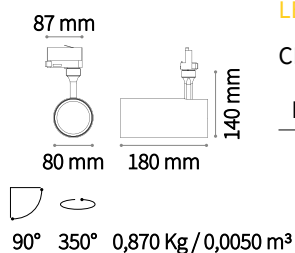

LED COB CITIZEN Driver TRIDONIC ON/OFF incluso

CRI ≥82

Potenza	Angolo	Flux	CCT	Finitura	Codice	€
20 W	24°	2350 Lm	3000 K	Bianco	189635	124
				Nero	189642	124
	36°	2500 Lm	4000 K	Bianco	189673	124
				Nero	189680	124
		2350 Lm	3000 K	Bianco	189819	124
				Nero	189826	124
	50°	2500 Lm	4000 K	Bianco	189857	124
				Nero	189864	124
		2350 Lm	3000 K	Bianco	189994	124
				Nero	190006	124
	2500 Lm	4000 K	Bianco	190013	124	
			Nero	190020	124	

90° 350° 0,870 Kg / 0,0050 m³

CRI ≥92

Potenza	Angolo	Flux	CCT	Finitura	Codice	€
20 W	24°	2200 Lm	3000 K	Bianco	189659	124
				Nero	189666	124
	36°	2200 Lm	3000 K	Bianco	189833	124
				Nero	189840	124
	50°	2200 Lm	3000 K	Bianco	190037	124
				Nero	190044	124

OPTIONAL Non incluso



Finitura	Codice	€
Filtro Honeycomb	190181	4



Finitura	Codice	€
Filtro Ellittico	190259	6



Finitura	Codice	€
Anello Bianco	189529	10



Finitura	Codice	€
Connessione singola Bianco	170145	21
Nero	170152	21

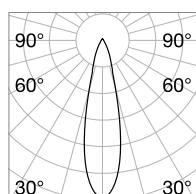

m	lx	øm
1	8787	0,42
2	2196	0,85
3	976	1,28
4	549	1,71
5	351	2,14

CRI≥82 20W 24° 2350 Lm 3000 K

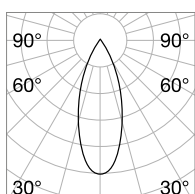

m	lx	øm
1	4526	0,64
2	1131	1,28
3	502	1,92
4	282	2,56
5	181	3,20

CRI≥82 20W 36° 2350 Lm 3000 K

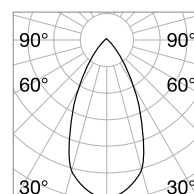

m	lx	øm
1	2657	0,93
2	664	1,87
3	295	2,81
4	166	3,75
5	106	4,69

CRI≥82 20W 50° 2350 Lm 3000 K



Smile 30W

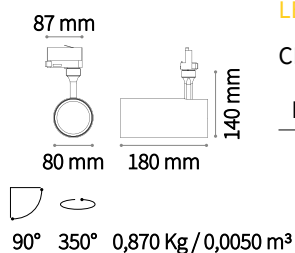

LED COB CITIZEN Driver TRIDONIC ON/OFF incluso

CRI ≥82

Potenza	Angolo	Flux	CCT	Finitura	Codice	€
30 W	24°	3150 Lm	3000 K	Bianco	189697	135
				Nero	189703	135
	36°	3400 Lm	4000 K	Bianco	189734	135
				Nero	189741	135
		3150 Lm	3000 K	Bianco	189871	135
				Nero	189888	135
	50°	3400 Lm	4000 K	Bianco	189895	135
				Nero	189901	135
		3150 Lm	3000 K	Bianco	190051	135
				Nero	190068	135
	3400 Lm	4000 K	Bianco	190075	135	
			Nero	190082	135	

90° 350° 0,870 Kg / 0,0050 m³

CRI ≥92

Potenza	Angolo	Flux	CCT	Finitura	Codice	€
30 W	24°	2900 Lm	3000 K	Bianco	189710	135
				Nero	189727	135
	36°	2900 Lm	3000 K	Bianco	189918	135
				Nero	189925	135
	50°	2900 Lm	3000 K	Bianco	190099	135
				Nero	190105	135

OPTIONAL Non incluso



Finitura	Codice	€
Filtro Honeycomb	190181	4



Finitura	Codice	€
Filtro Ellittico	190259	6



Finitura	Codice	€
Anello Bianco	189529	10



Finitura	Codice	€
Connessione singola Bianco	170145	21
Nero	170152	21

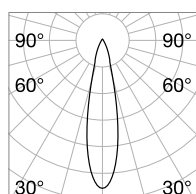

m	lx	øm
1	12955	0,39
2	3238	0,79
3	1439	1,19
4	809	1,59
5	518	1,99

CRI ≥82 30W 24° 3150 Lm 3000 K

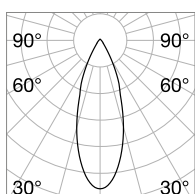

m	lx	øm
1	6240	0,62
2	1560	1,24
3	693	1,86
4	390	2,48
5	249	3,10

CRI ≥82 30W 36° 3150 Lm 3000 K

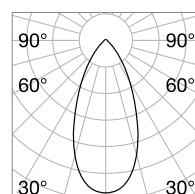

m	lx	øm
1	3740	0,88
2	935	1,76
3	415	2,65
4	233	3,53
5	149	4,42

CRI ≥82 30W 50° 3150 Lm 3000 K



Fox new

Sorgente	LED COB	CRI	≥80
Potenza	8W / 15W / 25W	Durata LED	30.000 h
Driver incluso	On/Off	Classe isolamento	I
Driver disponibili	No	IP	20
Binario	Trifase (standard Eutrac)	Materiale	Alluminio
CCT	3000 K	Garanzia	5 anni

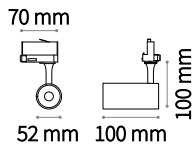

LED COB BRIDGELUX Driver ON/OFF incluso

Potenza	Angolo	Flux	CCT	Finitura	Codice	€
8 W	41°	950 Lm	3000 K	Bianco	250410	38 <small>new</small>
				Nero	250403	38 <small>new</small>



90° 350° 0,300 Kg/0,0013 m³

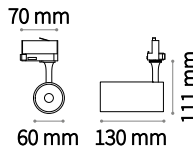

LED COB BRIDGELUX Driver ON/OFF incluso

Potenza	Angolo	Flux	CCT	Finitura	Codice	€
15 W	41°	1500 Lm	3000 K	Bianco	250434	43 <small>new</small>
				Nero	250427	43 <small>new</small>



90° 350° 0,380 Kg/0,0019 m³

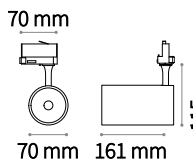

LED COB BRIDGELUX Driver ON/OFF incluso

Potenza	Angolo	Flux	CCT	Finitura	Codice	€
25 W	35°	2500 Lm	3000 K	Bianco	250458	49 <small>new</small>
				Nero	250441	49 <small>new</small>



90° 350° 0,540 Kg/0,0025 m³

OPTIONAL Non incluso



	Finitura	Codice	€
Connessione singola	Bianco	170145	21
	Nero	170152	21

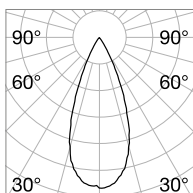

m	lx	øm
1	2067	0,77
2	517	1,54
3	230	2,30
4	129	3,07
5	83	3,84

CRI≥80 8W 41° 950 Lm 3000 K

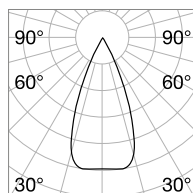

m	lx	øm
1	3204	0,80
2	801	1,60
3	356	2,40
4	200	3,20
5	128	4,00

CRI≥80 15W 41° 1500 Lm 3000 K

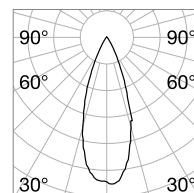

m	lx	øm
1	8140	0,61
2	2035	1,22
3	904	1,82
4	509	2,43
5	326	3,04

CRI≥80 25W 35° 2500 Lm 3000 K

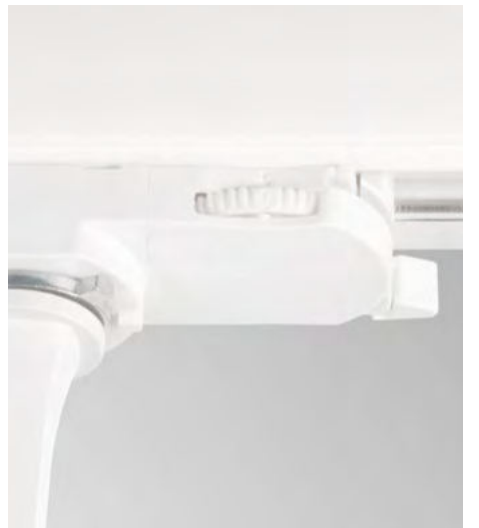



Glim **new**

□ IP20 ALLUMINIO

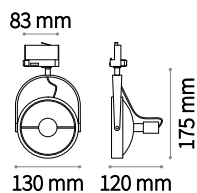

0,320 Kg / 0,0180 m³

GU10 Lampadine LED GU10 13W 3000 K include. Cod. **189031**

Potenza	Finitura	Codice	€
max 50W	Bianco	229676	80 new
	Nero	229683	80 new



P. 706

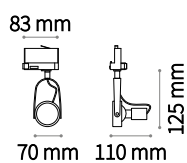

0,290 Kg / 0,0016 m³

GU10 Lampadine LED GU10 7W 3000 K include. Cod. **123943**

Potenza	Finitura	Codice	€
max 50W	Bianco	229652	50 new
	Nero	229669	50 new



P. 707



Slide new

 IP20 ALLUMINIO

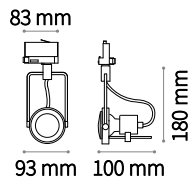

0,330 Kg / 0,0026 m³

GU10 Lampadine LED GU10 7W 3000 K incluse. Cod. **123943**

Potenza	Finitura	Codice	€
max 50W	Bianco	 239224	45 new
	Nero	 239217	45 new



P. 723

Lunare new

☐ IP20 ALLUMINIO

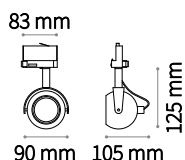

0,260 Kg / 0,0060 m³

GU10 Non inclusa - Lampadina consigliata **108292**

Potenza	Finitura	Codice	€
max 28W	Bianco	☐ 229737	40 <small>new</small>
	Nero	■ 229751	40 <small>new</small>



P. 182 P. 256

Mouse new

☐ IP20 ALLUMINIO

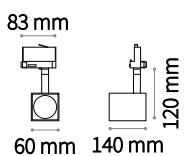

0,300 Kg / 0,0027 m³

GU10 Non inclusa - Lampadina consigliata **101378**

Potenza	Finitura	Codice	€
max 50W	Bianco	☐ 229768	55 <small>new</small>
	Nero	■ 229782	55 <small>new</small>



P. 720 P. 732

Spot new

⊕ IP20 ALLUMINIO

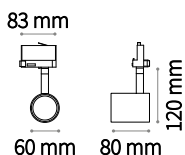

0,250 Kg / 0,0016 m³

GU10 Non inclusa - Lampadina consigliata **101378**

Potenza	Finitura	Codice	€
max 50W	Bianco	☐ 229706	45 <small>new</small>
	Nero	■ 229720	45 <small>new</small>



P. 721 P. 733



229720

229782

229751





Look new

⊕ IP20 ALLUMINIO



83 mm
397 mm
2445 mm
60 mm
0,930 Kg / 0,0037 m³

GU10 Lampadine LED GU10 7W 3000 K include. Cod. 101378

Potenza	Finitura	Codice	€
max 28W	Bianco	231662	70 <small>new</small>
	Nero	231631	70 <small>new</small>



Sky new

⊕ IP20 ALLUMINIO



83 mm
300 mm
1500 mm
60 mm
0,900 Kg / 0,0047 m³

GU10 Lampadine LED GU10 7W 3000 K include. Cod. 101378

Potenza	Finitura	Codice	€
max 28W	Bianco	231723	80 <small>new</small>
	Nero	231686	80 <small>new</small>





Frida **new**

☐ IP20 ALLUMINIO



83 mm
80 mm
50 mm
2325 mm
0,270 Kg / 0,0015 m³

E27 Non inclusa - Lampadina consigliata 151717

Potenza	Finitura	Codice	€
max 60W	Brunito	248493	40 new
	Nero	231754	40 new
	Rame Ant.	248509	40 new



P. 352

P. 492



Mr Jack **new**

IP20 ALLUMINIO



83 mm
100 mm
110 mm
2195 mm
0,070 Kg / 0,0037 m³

GU10 Lampadine LED GU10 7W 3000 K include. Cod. 101378

Potenza	Finitura	Codice	€
max 28W	Nero	248561	75 new



P. 055

Metro **new**

IP20 ALLUMINIO



83 mm
250 mm
270 mm
2495 mm
0,980 Kg / 0,0257 m³

E27 Non inclusa - Lampadina consigliata 101354

Potenza	Finitura	Codice	€
max 60W	Nero	231815	65 new



P. 368



Moby **new**

☐ IP20 ALLUMINIO

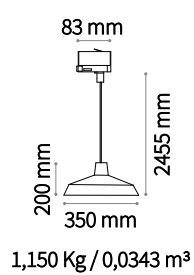

E27 Non inclusa - Lampadina consigliata **101330**

Potenza	Finitura	Codice	€
max 60W	Nero	■ 231839	100 new



P. 373

Link **new**

Profilo di alluminio estruso per binari elettrificati trifase; verniciatura a polveri in bianco o nero, ottimizzato per proiettori SMILE in versione on-off e per proiettori QUICK in versione on-off e dimmerabile DALI e 1-10V; disponibile nelle versioni a plafone, a sospensione oppure a incasso a filo su soffitti di cartongesso; adatto a sistemi di file continue, moduli standard da 2000 mm o 3000 mm, sezionabili a misura e componibili secondo schema desiderato. Ideale per l'installazione in grandi ambienti dove viene richiesta grande flessibilità, ad esempio spazi MUSEALI, COMMERCIALI e RETAIL. Garanzia 5 anni.





Link Trimless On/Off

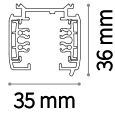

TRACK

Lunghezza	Peso	Volume	Finitura	Codice	€
1000 mm	0,94 Kg	0,0016 m ³	Bianco	243269	35 <small>new</small>
			Nero	243252	35 <small>new</small>
2000 mm	1,93 Kg	0,0032 m ³	Bianco	187976	60
			Nero	187983	60
3000 mm	2,87 Kg	0,0048 m ³	Bianco	187990	85
			Nero	188003	85

REQUIRED Non incluso - 1 kit x 1000 mm



Finitura	Codice	€	
Kit Soffitto	Bianco	169972	5
	Nero	169989	5



Rosone	N° Cavi	Lunghezza cavi	Finitura	Codice	€	
Kit Sospensione	Sì	1	1570 mm	Bianco	169958	12
	Sì	1	5000 mm	Bianco	216829	15
	No	1	3000 mm	Bianco	242705	12 <small>new</small>
				Nero	243283	12 <small>new</small>
	No	1	5000 mm	Bianco	243245	14 <small>new</small>
				Nero	243238	14 <small>new</small>

169613 187976 169705 227580 169736 169637 169590
169620 187983 169712 227597 169729 169644 169606

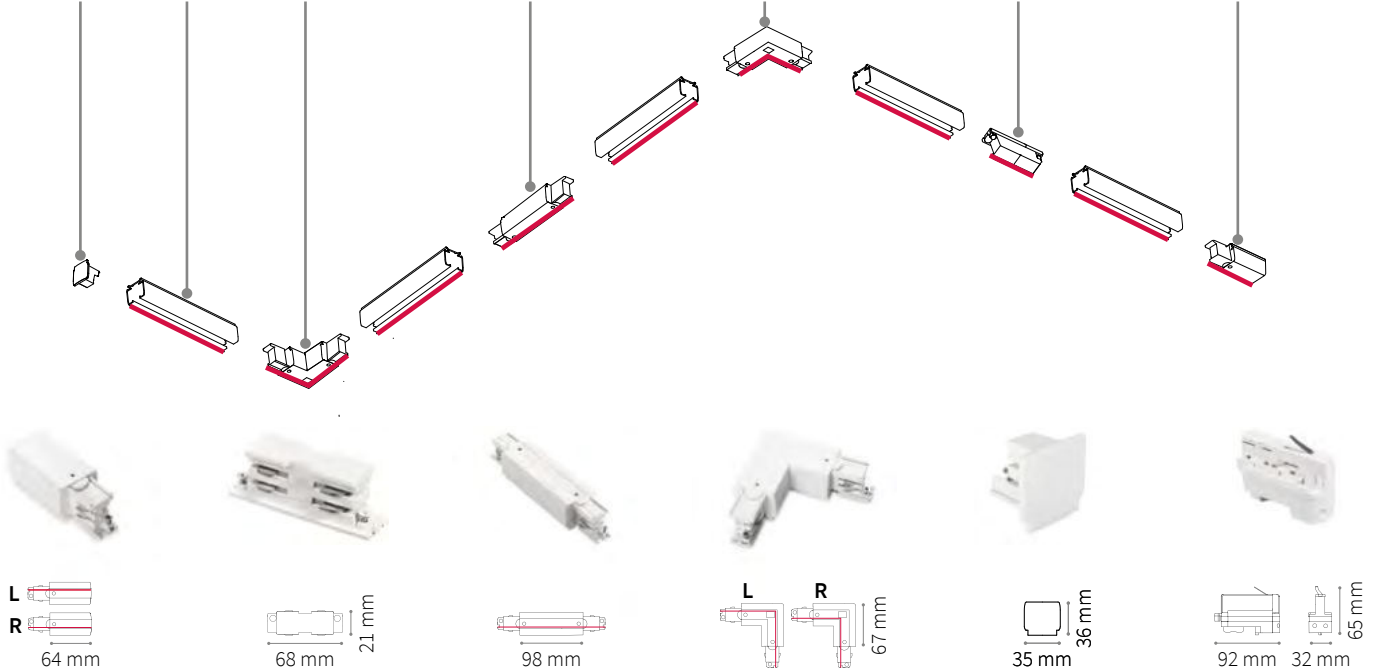

MAIN CONNECTOR

0,060 Kg / 0,0002 m³
169583 L € 12
169576 R € 12
169590 R € 12
169606 R € 12

ELECTRIFIED CONNECTOR

0,030 Kg / 0,0001 m³
169637 € 6
169644 € 6

MIDDLE CONNECTOR

0,120 Kg / 0,0004 m³
227580 € 20
227597 € 20

L CONNECTOR

0,110 Kg / 0,0005 m³
169705 L € 20
169712 L € 20
169736 R € 20
169729 R € 20

END CAP

0,010 Kg / 0,0001 m³
169613 € 2
169620 € 2

TRACK CONNECTOR

0,080 Kg / 0,0002 m³
194257 € 10
194301 € 10

Link Trimless DALI

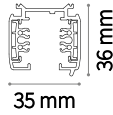

TRACK

Lunghezza	Peso	Volume	Finitura	Codice	€
1000 mm	0,94 Kg	0,0016 m ³	Bianco	246468	34 <i>new</i>
			Nero	246451	34 <i>new</i>
2000 mm	1,93 Kg	0,0032 m ³	Bianco	247007	67 <i>new</i>
			Nero	246901	67 <i>new</i>
3000 mm	2,87 Kg	0,0048 m ³	Bianco	247625	98 <i>new</i>
			Nero	247618	98 <i>new</i>

REQUIRED Non incluso - 1 kit x 1000 mm



Finitura	Codice	€
Bianco	169972	5
Nero	169989	5



Rosone	N° Cavi	Lunghezza cavi	Finitura	Codice	€	
Kit Sospensione	Sì	1	1570 mm	Bianco	169958	12
	Sì	1	5000 mm	Bianco	216829	15
	No	1	3000 mm	Bianco	242705	12 <i>new</i>
				Nero	243283	12 <i>new</i>
	No	1	5000 mm	Bianco	243245	14 <i>new</i>
				Nero	243238	14 <i>new</i>

169613 247007 246604 246581 246628 246567 246543
 169620 246901 246598 246574 246611 246550 246536

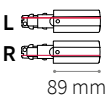
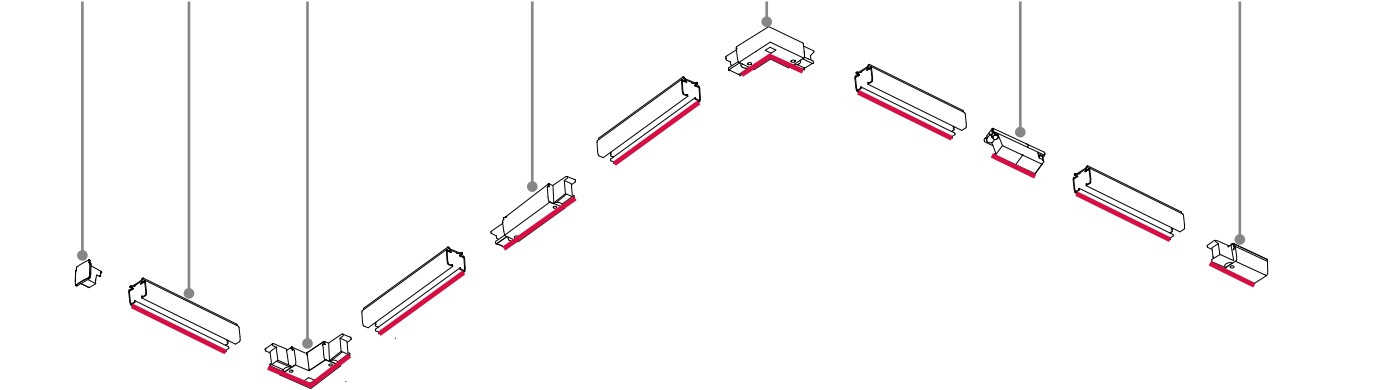

MAIN CONNECTOR

0,079 Kg / 0,0002 m³
 246529 L € 13 *new*
 246512 L € 13 *new*
 246543 R € 13 *new*
 246536 R € 13 *new*

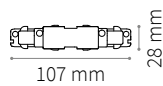

ELECTRIFIED CONNECTOR

0,041 Kg / 0,0001 m³
 246567 € 9 *new*
 246550 € 9 *new*

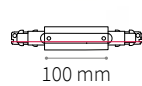

MIDDLE CONNECTOR

0,129 Kg / 0,0004 m³
 246581 € 22 *new*
 246574 € 22 *new*

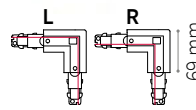

L CONNECTOR

0,130 Kg / 0,0006 m³
 246604 L € 23 *new*
 246598 L € 23 *new*
 246628 R € 23 *new*
 246611 R € 23 *new*



END CAP

0,010 Kg / 0,0001 m³
 169613 € 2
 169620 € 2

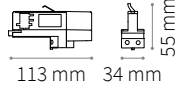

TRACK CONNECTOR

0,063 Kg / 0,0003 m³
 246505 € 15 *new*
 246499 € 15 *new*



Link Trim On/Off

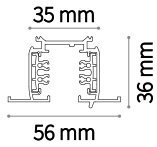

TRACK

Lunghezza	Peso	Volume	Finitura	Codice	€
2000 mm	2,11 Kg	0,0048 m ³	Bianco	188010	65
			Nero	188027	65

REQUIRED Non incluso - 1 kit x 1000 mm



	Codice	€
Kit Incasso	188195	4

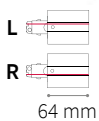
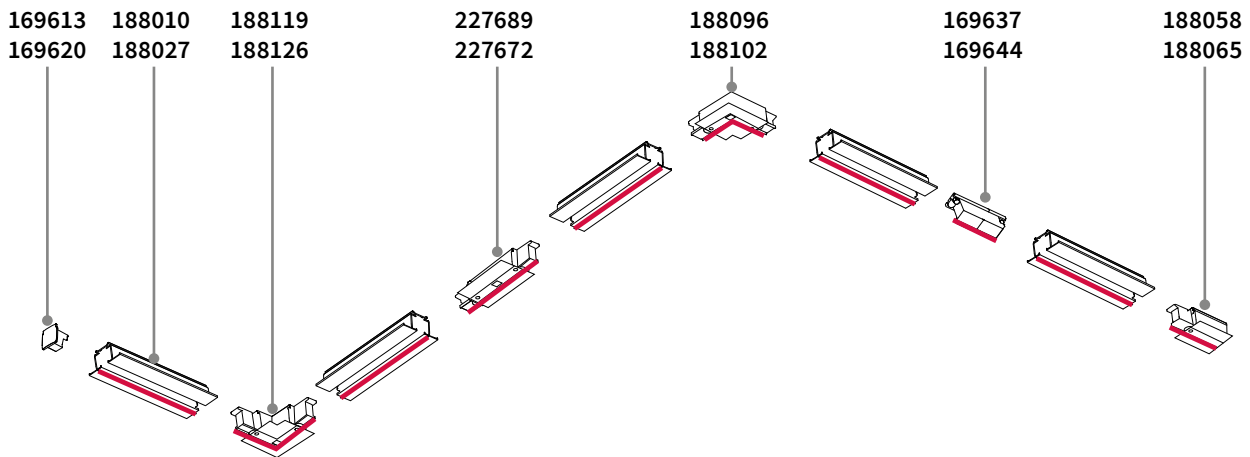

MAIN CONNECTOR

0,070 Kg / 0,0002 m ³		
188072	L	€ 13
188089	L	€ 13
188058	R	€ 13
188065	R	€ 13

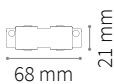

ELECTRIFIED CONNECTOR

0,030 Kg / 0,0001 m ³		
169637	€	6
169644	€	6

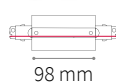

MIDDLE CONNECTOR

0,130 Kg / 0,0004 m ³		
227689	€	22
227672	€	22

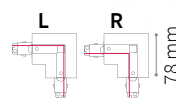

L CONNECTOR

0,120 Kg / 0,0006 m ³		
188119	L	€ 22
188126	L	€ 22
188096	R	€ 22
188102	R	€ 22



END CAP

0,010 Kg / 0,0001 m ³		
169613	€	2
169620	€	2

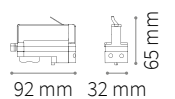

TRACK CONNECTOR

0,080 Kg / 0,0002 m ³		
194257	€	10
194301	€	10

Link Trim DALI

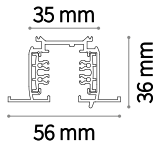

TRACK

Lunghezza	Peso	Volume	Finitura	Codice	€
2000 mm	2,11 Kg	0,0048 m ³	Bianco	246895	73 <small>new</small>
			Nero	249629	73 <small>new</small>

REQUIRED Non incluso - 1 kit x 1000 mm



	Codice	€
Kit Incasso	188195	4

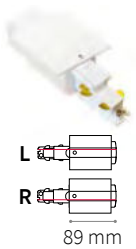
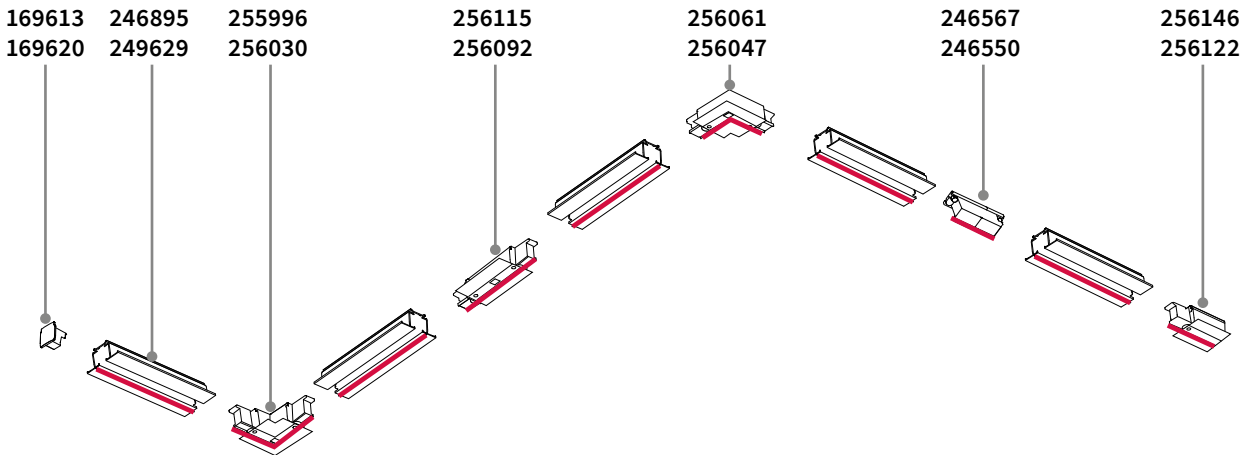

MAIN CONNECTOR

0,089 Kg / 0,0002 m ³					
256085	L	€ 14 <small>new</small>			
256078	L	€ 14 <small>new</small>			
256146	R	€ 14 <small>new</small>			
256122	R	€ 14 <small>new</small>			

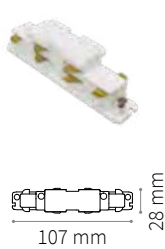

ELECTRIFIED CONNECTOR

0,041 Kg / 0,0001 m ³					
246567	€ 9 <small>new</small>				
246550	€ 9 <small>new</small>				



MIDDLE CONNECTOR

0,143 Kg / 0,004 m ³					
256115	€ 24 <small>new</small>				
256092	€ 24 <small>new</small>				

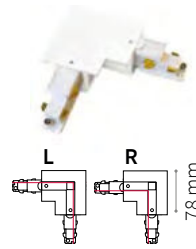

L CONNECTOR

0,140 Kg / 0,0007 m ³					
255996	L	€ 25 <small>new</small>			
256030	L	€ 25 <small>new</small>			
256061	R	€ 25 <small>new</small>			
256047	R	€ 25 <small>new</small>			



END CAP

0,010 Kg / 0,0001 m ³					
169613	€ 2				
169620	€ 2				

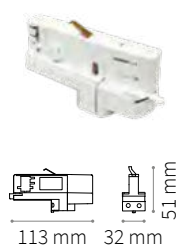

TRACK CONNECTOR

0,063 Kg / 0,0003 m ³					
246505	€ 15 <small>new</small>				
246499	€ 15 <small>new</small>				

Tecnico

Lampade da soffitto



Nova 662



Led Panel 664



Lika 666



Dynamic 678



Dynamic 680



Game 684



Game 686



Groove 696



Groove 696



Delta 698



Eye 700



Zephyr 701



Samba 702



Samba 703



Lounge 704



Funky 704



Blues 705



Blues 705



Soul-1 705



Soul-2 705



Glim 706



Glim Compact 707



Channel 708



Halo 709



Polo 710



Ufo 711



Universal 712



Nitro 716



Nitro 716



Mood 717



Mood 717



Oak 718



Oak 718



Tower 719



Mouse 720



Spot 721



Rudy 722



Slide 723



Basic 688



Deep 694



Jazz 704



Swing 704



Look 714



Sky 715



Tower 719



Kool 719



Sky

Pag 715

Nova new

Sorgente	LED COB
Potenza	12W / 30W
Driver incluso	On/Off
Driver disponibili	1-10V / DALI / Push
CCT	3000 K
CRI	≥90

Durata LED	30.000 h
Classe isolamento	II
IP	20
Materiale	Alluminio
Garanzia	5 anni

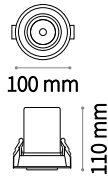

① 90 mm
0,550 Kg / 0,0016 m³

LED COB PHILIPS Driver ON/OFF incluso - UGR <19

Potenza	Angolo	Flux	CCT	Finitura	Codice	€
12 W	38°	1000 Lm	3000 K	Bianco	248165	56 new
				Nero	248189	56 new

DIMMABLE DRIVER Non incluso/Optional

	Potenza	Range	Output	Misura	Codice	€
1-10V	15 W	150-700 mA	300 mA	167x41x31 mm	243993	26 new
DALI/Push	12 W	100-400 mA	300 mA	135x30x20 mm	243986	33 new

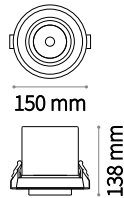

① 140 mm
1,160 Kg / 0,0039 m³

LED COB PHILIPS Driver ON/OFF incluso - UGR <22

Potenza	Angolo	Flux	CCT	Finitura	Codice	€
30 W	38°	3150 Lm	3000 K	Bianco	248172	95 new
				Nero	248196	95 new

DIMMABLE DRIVER Non incluso/Optional

	Potenza	Range	Output	Misura	Codice	€
1-10V	30 W	300-900 mA	750 mA	167x41x32 mm	248370	60 new
DALI/Push	36 W	200-1200 mA	700 mA	167x39x30 mm	248592	85 new

OPTIONAL Non incluso



	Angolo	Codice	€
Lente 12 W	15°	244013	3 new
Lente 30 W	15°	248608	7 new

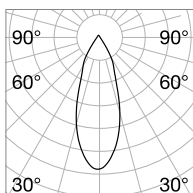

m	lx	øm
1	1768	0,66
2	442	1,32
3	196	1,97
4	111	2,63
5	71	3,29

CRI≥90 12W 38° 1000 Lm 3000 K

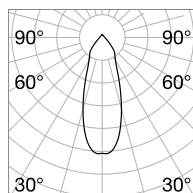

m	lx	øm
1	4671	0,64
2	1168	1,28
3	519	1,93
4	292	2,57
5	187	3,21

CRI≥90 30W 38° 3150 Lm 3000K



Led Panel new

Sorgente	LED SMD
Potenza	38,5W
Driver incluso	On/Off
Driver disponibili	1-10V / DALI / Push
MacAdam	SDCM ≤4
CCT	3000 K / 4000 K
CRI	≥80 / ≥90

UGR	<19
Durata LED	25.000 h
Classe isolamento	II
IP	20
Materiale	Alluminio
Garanzia	5 anni

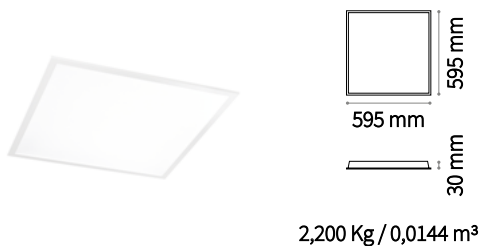

2,200 Kg / 0,0144 m³

LED SMD Driver ON/OFF incluso

CRI ≥80

Potenza	Angolo	Flux	CCT	Finitura	Codice	€
38,5 W	81°	3800 Lm	3000 K	Bianco	 249711	45 new
		3950 Lm	4000 K	Bianco	 249728	45 new

CRI ≥90

Potenza	Angolo	Flux	CCT	Finitura	Codice	€
38,5 W	81°	3800 Lm	3000 K	Bianco	 246390	45 new
		3950 Lm	4000 K	Bianco	 244181	45 new

DIMMABLE DRIVER Non incluso/Optional

	Potenza	Range	Output	Misura	Codice	€
1-10V	40 W	850-1050 mA	1000 mA	125x83x26mm	247854	30 new
DALI/Push	40 W	550-1050 mA	1000 mA	106x69x28mm	247847	55 new

MOUNTING KIT Non incluso/Optional



	Rosone	N° Cavi	Lunghezza cavi	Finitura	Codice	€
Kit Sospensione	No	4	1000 mm	Grigio	 244198	4 new

	Finitura	Codice	€
Kit Soffitto	Grigio	 244204	3 new

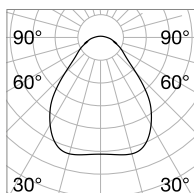

m	lx	øm
1	1470	1,79
2	367	3,59
3	163	5,38
4	92	7,18
5	59	8,97

CRI≥80 38,5W 81° 3800 Lm 3000 K



Lika **new**

Famiglia di moduli LED rettangolari in alluminio pressofuso, verniciato nero o bianco con riflettore in policarbonato. Disponibili nelle versioni TRIM con cornice, TRIMLESS con bordo arretrato per installazione a filo su soffitti in cartongesso oppure nella versione a plafone. Moduli disponibili con due, cinque oppure dieci lenti. Appositamente disegnato per evitare abbagliamenti ($UGR < 16$), trova la sua migliore collocazione all'interno di UFFICI e spazi COMMERCIALI.

Sorgente	LED SMD
Potenza	4W / 10W / 20W
Driver incluso	On/Off
Driver disponibili	No
CCT	3000 K
CRI	≥ 90
UGR	< 16
Durata LED	30.000 h
Classe isolamento	II
IP	20
Materiale	Alluminio
Garanzia	5 anni





Lika Trim



45 mm



74 mm

68 x 37 mm
0,130 Kg / 0,0005 m³

LED COB OSRAM Driver ON/OFF incluso

Potenza	Angolo	Flux	CCT	Finitura	Codice	€
4 W	29°	440 Lm	3000 K	Nero	206196	34



45 mm

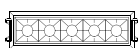

146 mm

140 x 37 mm
0,240 Kg / 0,0008 m³

LED COB OSRAM Driver ON/OFF incluso

Potenza	Angolo	Flux	CCT	Finitura	Codice	€
10 W	29°	1100 Lm	3000 K	Nero	206219	50



45 mm

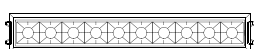

278 mm

273 x 37 mm
0,480 Kg / 0,0016 m³

LED COB OSRAM Driver ON/OFF incluso

Potenza	Angolo	Flux	CCT	Finitura	Codice	€
20 W	29°	2200 Lm	3000 K	Nero	206233	96

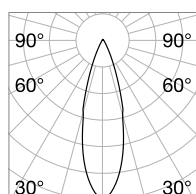

m	lx	øm
1	2091	0,58
2	523	1,16
3	232	1,74
4	131	2,32
5	70	2,90

CRI≥90 10W 29° 1100 Lm 3000K



Lika Trimless

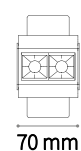
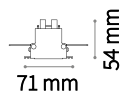

75 x 70 mm
0,220 Kg / 0,0006 m³

LED COB OSRAM Driver ON/OFF incluso

Potenza	Angolo	Flux	CCT	Finitura	Codice	€
4 W	29°	440 Lm	3000 K	Nero	206202	46

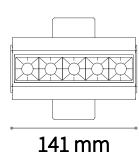
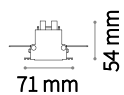

145 x 70 mm
0,390 Kg / 0,0013 m³

LED COB OSRAM Driver ON/OFF incluso

Potenza	Angolo	Flux	CCT	Finitura	Codice	€
10 W	29°	1100 Lm	3000 K	Nero	206226	77

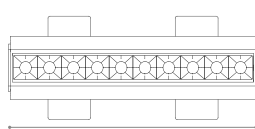
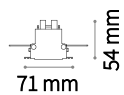

278 x 70 mm
0,720 Kg / 0,0023 m³

LED COB OSRAM Driver ON/OFF incluso

Potenza	Angolo	Flux	CCT	Finitura	Codice	€
20 W	29°	2200 Lm	3000 K	Nero	206240	124

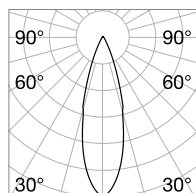

m	lx	øm
1	2786	0,58
2	696	1,16
3	309	1,74
4	174	2,32
5	111	2,90

CRI≥90 10W 29° 1100 Lm 3000K



Lika Surface

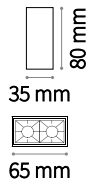

0,210 Kg / 0,0008 m³

LED COB OSRAM Driver ON/OFF incluso

Potenza	Angolo	Flux	CCT	Finitura	Codice	€
4 W	44°	440 Lm	3000 K	Bianco	248523	55 <i>new</i>
				Nero	244860	55 <i>new</i>

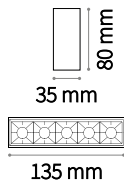

0,370 Kg / 0,0011 m³

LED COB OSRAM Driver ON/OFF incluso

Potenza	Angolo	Flux	CCT	Finitura	Codice	€
10 W	44°	1100 Lm	3000 K	Bianco	248530	73 <i>new</i>
				Nero	244884	73 <i>new</i>

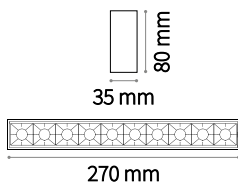

0,710 Kg / 0,0020 m³

LED COB OSRAM Driver ON/OFF incluso

Potenza	Angolo	Flux	CCT	Finitura	Codice	€
20 W	44°	2200 Lm	3000 K	Bianco	248516	122 <i>new</i>
				Nero	244891	122 <i>new</i>

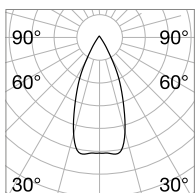

m	lx	øm
1	2342	0,81
2	586	1,62
3	260	2,42
4	146	3,23
5	94	4,04

CRI≥90 10W 44° 1100 Lm 3000 K



Dynamic **new**

Sistema componibile di elementi ad incasso in alluminio costituito da sorgente, riflettore e ghiera, con lenti e schermi in opzione; finitura bianca, cromo, nera, oro; incasso possibile di forma rotonda o quadrata, riflettore simmetrico o asimmetrico; tre diversi angoli di emissione a scelta. Sorgente luminosa con tecnologia COB LED integrato per la massima efficienza, disponibile con una temperatura di colore di 2700 K, 3000 K o 4000 K; LED ad efficienza energetica ad elevata resa cromatica; CRI ≥ 90 ; binning iniziale ≤ 3 -Step MacAdam; protezione frontale IP54 (a prodotto installato); classe isolamento II. Disponibile in versione dimmerabile sia DALI che 1-10V. Per la sua dimensione compatta e grande versatilità è ottimale nelle installazioni di ambienti interni DOMESTICI, DIREZIONALI e RETAIL.

IP54 Grado di protezione IP54.

Sorgente	LED COB
Potenza	9W / 10W / 15W
Driver incluso	On/Off
Driver disponibili	1-10V / DALI
MacAdam	SDCM 3
CCT	2700 K / 3000 K / 4000 K
CRI	≥ 90
Durata LED	50.000 h
Classe isolamento	II
IP	54
Materiale	Alluminio
Garanzia	5 anni



Dynamic - Source

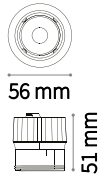

0,180 Kg / 0,0030 m³

LED COB CITIZEN Non incluso/Necessario - Driver TRIDONIC ON/OFF incluso

Potenza	Angolo	Flux	CCT	Finitura	Codice	€
9 W	35°	950 Lm	2700 K	Nero	252971	43 <i>new</i>
		1000 Lm	3000 K	Nero	252988	43 <i>new</i>
		1050 Lm	4000 K	Nero	252995	43 <i>new</i>

DIMMABLE DRIVER Non incluso/Optional

Potenza	Range	Output	Misura	Codice	€
1-10V	12 W	120-350 mA	200 mA	125x45x27 mm	253008 20 <i>new</i>
DALI	11 W	100-400 mA	200 mA	135x30x20 mm	253015 52 <i>new</i>

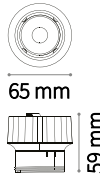

0,150 Kg / 0,0030 m³

LED COB CITIZEN Non incluso/Necessario - Driver ON/OFF incluso

Potenza	Angolo	Flux	CCT	Finitura	Codice	€
10 W	35°	1150 Lm	2700 K	Nero	208541	53
		1250 Lm	3000 K	Nero	208558	53
		1300 Lm	4000 K	Nero	208565	53

DIMMABLE DRIVER Non incluso/Optional

Potenza	Range	Output	Misura	Codice	€
1-10V	10 W	-	250 mA	135x20x30 mm	216317 35
DALI	17 W	200-700 mA	250 mA	130x30x43 mm	216027 88

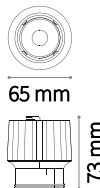

0,200 Kg / 0,0030 m³

LED COB CITIZEN Non incluso/Necessario - Driver ON/OFF incluso

Potenza	Angolo	Flux	CCT	Finitura	Codice	€
15 W	35°	1500 Lm	2700 K	Nero	208572	74
		1600 Lm	3000 K	Nero	208589	74
		1700 Lm	4000 K	Nero	208596	74

DIMMABLE DRIVER Non incluso/Optional

Potenza	Range	Output	Misura	Codice	€
1-10V	20 W	-	250 mA	101x29x51 mm	216324 40
DALI	17 W	200-700 mA	250 mA	130x30x43 mm	216263 94

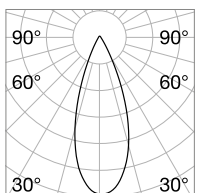

m	lx	øm
1	1653	0,72
2	413	1,44
3	184	2,16
4	103	2,88
5	66	3,60

CRI≥90 9W 35° 1000 Lm 3000 K

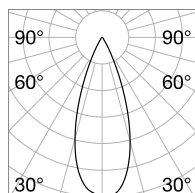

m	lx	øm
1	1643	0,66
2	410	1,32
3	182	1,98
4	102	2,64
5	65	3,30

CRI≥90 10W 35° 1250 Lm 3000K

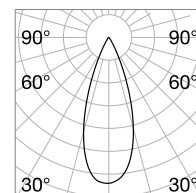

m	lx	øm
1	2294	0,64
2	573	1,29
3	254	1,93
4	143	2,58
5	91	3,23

CRI≥90 15W 35° 1600 Lm 3000K

Dynamic - Optional

LENS Non incluso/Optional



Angolo	Codice	€
20°	211763	5
35°	208664	5 <i>new</i>
55°	211770	5

FILTER Non incluso/Optional





Finitura	Codice	€
Honeycomb	208671	5



Finitura	Codice	€
Ellittico	208688	5

GU10 ADAPTOR Non incluso/Optional



Finitura	Codice	€
Bianco	 208640	9
Nero	 208657	9



Dynamic Round

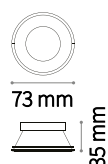
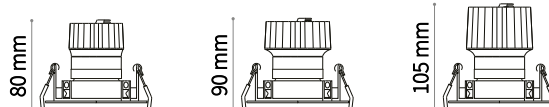

0,020 Kg / 0,0002 m³

REFLECTOR Non incluso/Necessario

SIMMETRICO

Finitura	Codice	€
Bianco	211787	6
Cromo	221649	7
Nero	211794	6
Oro	211800	6

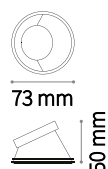

0,020 Kg / 0,0002 m³

ASIMMETRICO - 30°

Finitura	Codice	€
Bianco	211848	6
Cromo	221663	8
Nero	211855	6
Oro	211862	6

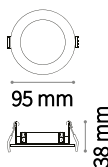

0,060 Kg / 0,0004 m³

FRAME Non incluso/Necessario

Finitura	Codice	€
Bianco	208695	13
Cromo	221687	16
Nero	208701	13
Oro	208718	13



Dynamic Square

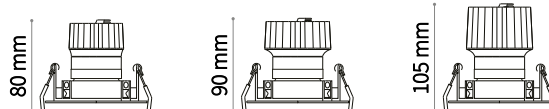

REFLECTOR Non incluso/Necessario

SIMMETRICO

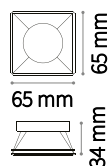

0,020 Kg / 0,0002 m³

Finitura	Codice	€
Bianco	211817	6
Cromo	221656	7
Nero	211824	6
Oro	211831	6

ASIMMETRICO - 30°

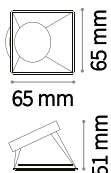

0,020 Kg / 0,0002 m³

Finitura	Codice	€
Bianco	211879	6
Cromo	221670	8
Nero	211886	6
Oro	211893	6

FRAME Non incluso/Necessario

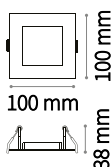

Ⓢ 90 mm
0,050 Kg / 0,004 m³

Finitura	Codice	€
Bianco	208725	15
Cromo	221694	19
Nero	208732	15
Oro	208749	15

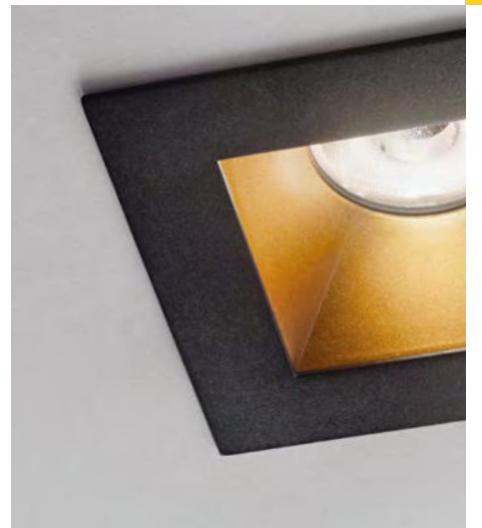
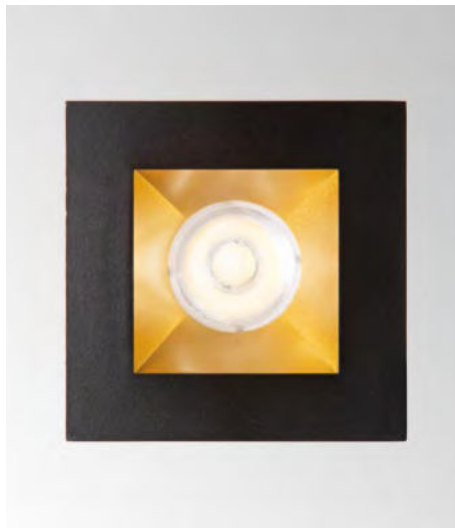

Game

Faretto ad incasso in alluminio pressofuso con ghiera rotonda o quadrata, adatto per installazione su soffitti in cartongesso. Finitura cromata opaca, bianca opaca RAL 9001, nera opaca RAL 9011, oro opaca RAL 1032. Tecnologia COB-Chip On Board per la massima efficienza; disponibile in temperatura di colore 3000 K; CRI ≥ 85 . Montaggio e smontaggio senza utensili; protezione IP20; classe isolamento II. In opzione dimmerabile 1-10V e DALI.

Sorgente	LED COB
Potenza	11W
Driver incluso	On/Off
Driver disponibili	1-10V / DALI
CCT	3000 K
CRI	≥ 85
UGR	<19
Durata LED	30.000 h
Classe isolamento	II
IP	20
Materiale	Alluminio
Garanzia	5 anni





Game Round

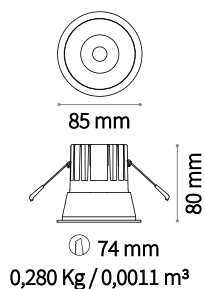

LED COB CREE Driver ON/OFF incluso

Potenza	Angolo	Flux	CCT	Finitura	Codice	€
11 W	36°	850 Lm	3000 K	Argento	192284	39
				Bianco	192291	39
				Nero	192277	39
				Oro	192307	39

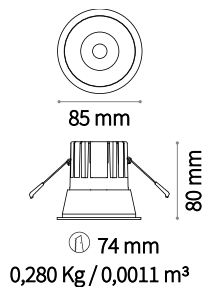

LED COB CREE Driver ON/OFF incluso

Potenza	Angolo	Flux	CCT	Finitura	Codice	€
11 W	36°	850 Lm	3000 K	Argento	192321	39
				Bianco	192338	39
				Nero	192314	39
				Oro	192345	39

DIMMABLE DRIVER Non incluso/Optional

	Potenza	Range	Output	Misura	Codice	€
1-10V	12 W	100-400 mA	250 mA	150x43x29 mm	217253	30
DALI	11 W	-	250 mA	130x43x30 mm	202396	39

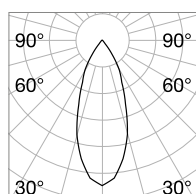

m	lx	ø m
1	1545	0,69
2	386	1,38
3	171	2,07
4	96	2,77
5	61	3,46

CRI≥85 11W 36° 850 Lm 3000K



Game Square



84 mm









120 mm

75 mm

0,27 Kg / 0,0011 m³

LED COB CREE Driver ON/OFF incluso

Potenza	Angolo	Flux	CCT	Finitura	Codice	€
11 W	36°	850 Lm	3000 K	Argento  + 	192369	39
				Bianco  + 	192376	39
				Nero  + 	192352	39



84 mm









120 mm

75 mm

0,27 Kg / 0,0011 m³

LED COB CREE Driver ON/OFF incluso

Potenza	Angolo	Flux	CCT	Finitura	Codice	€
11 W	36°	850 Lm	3000 K	Argento  + 	192390	39
				Bianco  + 	192406	39
				Nero  + 	192383	39

DIMMABLE DRIVER Non incluso/Optional

	Potenza	Range	Output	Misura	Codice	€
1-10V	12 W	100-400 mA	250 mA	150x43x29 mm	217253	30
DALI	11 W	-	250 mA	130x43x30 mm	202396	39

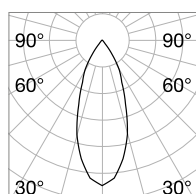

m	lx	ø m
1	1545	0,69
2	386	1,38
3	171	2,07
4	96	2,77
5	61	3,46

CRI≥85 11W 36° 850 Lm 3000K

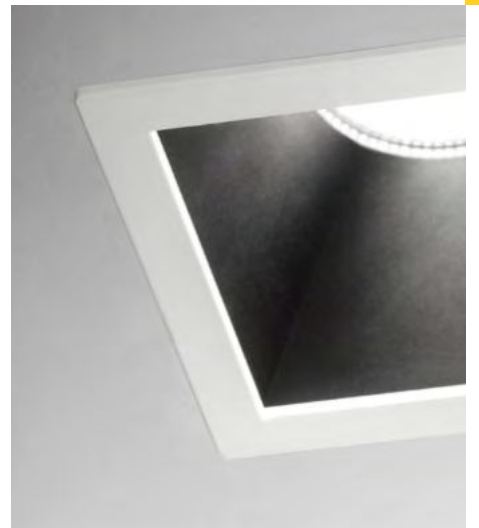

Basic

Faretto a incasso in alluminio pressofuso con ghiera rotonda, adatto per installazione su soffitti in cartongesso. Finitura bianca opaca; tecnologia COB Chip on Board e SMD. Disponibile in temperatura di colore 3000 K e 4000 K e con tre diverse ottiche; CRI ≥ 80 ; protezione frontale IP44 (a prodotto installato); classe isolamento II.

IP44 Grado di protezione IP44.

Sorgente	LED COB / SMD
Potenza	10W / 40W
Driver incluso	On/Off
Driver disponibili	1-10V / DALI
MacAdam	SDCM ≤ 4
CCT	3000 K / 4000 K
CRI	≥ 80
Durata LED	30.000 h
Classe isolamento	II
IP	44
Materiale	Alluminio
Garanzia	5 anni





Basic Accent

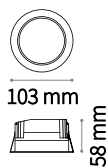

① 90 mm
0,400 Kg / 0,0017 m³

LED COB PHILIPS Driver PHILIPS ON/OFF incluso

Potenza	Angolo	Flux	CCT	Finitura	Codice	€
10 W	45°	1000 Lm	3000 K	Bianco	193458	50
		1050 Lm	4000 K	Bianco	193359	50

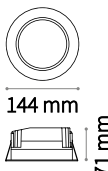

① 125 mm
0,660 Kg / 0,0027 m³

LED COB PHILIPS Driver PHILIPS ON/OFF incluso

Potenza	Angolo	Flux	CCT	Finitura	Codice	€
15 W	52°	1550 Lm	3000 K	Bianco	193465	65
		1650 Lm	4000 K	Bianco	193366	65
20 W		1900 Lm	3000 K	Bianco	193472	67
		2100 Lm	4000 K	Bianco	193373	67

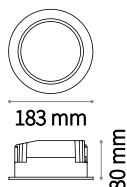

① 160 mm
1,250 Kg / 0,0056 m³

LED COB PHILIPS Driver PHILIPS ON/OFF incluso

Potenza	Angolo	Flux	CCT	Finitura	Codice	€
30 W	46°	2900 Lm	3000 K	Bianco	193489	109
		3150 Lm	4000 K	Bianco	193380	109

DIMMABLE DRIVER Non incluso/Optional

	Potenza	Range	Output	Misura	Codice	€
1-10V	12 W	200-350 mA	300 mA	150x43x29 mm	218823	25
	15 W	300-500 mA	450 mA	150x43x29 mm	218830	25
	20 W	300-700 mA	700 mA	150x43x29 mm	218847	28
	31 W	550-900 mA	900 mA	150x43x29 mm	218854	34
DALI	10 W	150-400 mA	300 mA	130x43x30 mm	220772	95
	17 W	250-700 mA	450 mA	130x43x30 mm	220796	102
	25 W	350-1050 mA	700 mA	130x43x30 mm	220789	110
	45 W	500-1400 mA	900 mA	150x43x30 mm	220802	117

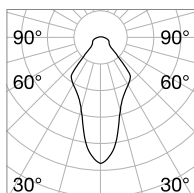

m	lx	øm
1	533	0,81
2	133	1,62
3	59	2,44
4	33	3,25
5	21	4,07

CRI≥80 10W 45° 1000 Lm 3000 K

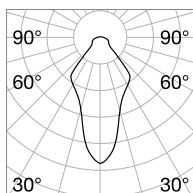

m	lx	øm
1	719	0,98
2	179	1,96
3	79	2,95
4	44	3,93
5	28	4,92

CRI≥80 15W 52° 1550 Lm 3000 K

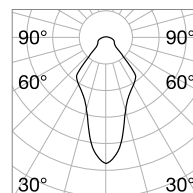

m	lx	øm
1	1250	0,92
2	312	1,84
3	138	2,76
4	78	3,69
5	50	4,61

CRI≥80 30W 46° 2900 Lm 3000 K



Basic Wide



103 mm



58 mm

① 90 mm

0,370 Kg / 0,0017 m³

LED SMD SAMSUNG Driver PHILIPS ON/OFF incluso

Potenza	Angolo	Flux	CCT	Finitura	Codice	€
10 W	85°	1000 Lm	3000 K	Bianco	193519	47
		1100 Lm	4000 K	Bianco	193403	47



144 mm



71 mm

① 125 mm

0,630 Kg / 0,0027 m³

LED SMD SAMSUNG Driver PHILIPS ON/OFF incluso

Potenza	Angolo	Flux	CCT	Finitura	Codice	€
15 W	87°	1500 Lm	3000 K	Bianco	193526	59
		1650 Lm	4000 K	Bianco	193410	59
20 W		1900 Lm	3000 K	Bianco	193533	64
		2100 Lm	4000 K	Bianco	193427	64



183 mm



80 mm

① 160 mm

1,130 Kg / 0,0056 m³

LED SMD SAMSUNG Driver PHILIPS ON/OFF incluso

Potenza	Angolo	Flux	CCT	Finitura	Codice	€
30 W	90°	2900 Lm	3000 K	Bianco	193540	103
		3150 Lm	4000 K	Bianco	193434	103

DIMMABLE DRIVER Non incluso/Optional

	Potenza	Range	Output	Misura	Codice	€
1-10V	12 W	200-350 mA	300 mA	150x43x29 mm	218823	25
	15 W	300-500 mA	450 mA	150x43x29 mm	218830	25
	20 W	300-700 mA	700 mA	150x43x29 mm	218847	28
	31 W	550-900 mA	900 mA	150x43x29 mm	218854	34
DALI	10 W	150-400 mA	300 mA	130x43x30 mm	220772	95
	17 W	250-700 mA	450 mA	130x43x30 mm	220796	102
	25 W	350-1050 mA	700 mA	130x43x30 mm	220789	110
	45 W	500-1400 mA	900 mA	150x43x30 mm	220802	117

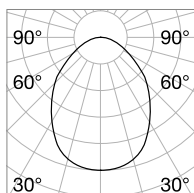

m	lx	øm
1	188	1,84
2	47	3,69
3	20	5,54
4	11	7,39
5	7	9,24

CRI≥80 10W 85° 1000 Lm 3000 K

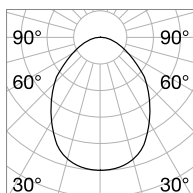

m	lx	øm
1	318	1,72
2	79	3,44
3	35	5,17
4	19	6,89
5	12	8,61

CRI≥80 15W 87° 1500 Lm 3000 K

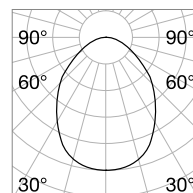

m	lx	øm
1	591	1,84
2	147	3,69
3	65	5,53
4	36	7,38
5	23	9,23

CRI≥80 30W 90° 2900 Lm 3000 K



Deep new

Sorgente	LED SMD
Potenza	10W / 20W / 30W
Driver incluso	On/Off
Driver disponibili	1-10V / DALI
CCT	3000 K / 4000 K
CRI	≥80

Durata LED	30.000 h
Classe isolamento	II
IP	20
Materiale	Alluminio
Garanzia	5 anni



LED SMD Driver ON/OFF incluso

Potenza	Angolo	Flux	CCT	Finitura	Codice	€
10 W	70°	1200 Lm	3000 K	Bianco	249018	23 new
			4000 K	Bianco	249025	23 new



LED SMD Driver ON/OFF incluso

Potenza	Angolo	Flux	CCT	Finitura	Codice	€
20 W	77°	2100 Lm	3000 K	Bianco	249032	49 new
			4000 K	Bianco	249049	49 new



LED SMD Driver ON/OFF incluso

Potenza	Angolo	Flux	CCT	Finitura	Codice	€
30 W	77°	3200 Lm	3000 K	Bianco	248783	69 new
			4000 K	Bianco	248790	69 new

DIMMABLE DRIVER Non incluso/Optional

	Potenza	Range	Output	Misura	Codice	€
1-10V	10 W	100-400 mA	300 mA	135x30x20 mm	248950	26 new
	25 W	200-900 mA	500 mA	167x41x32 mm	248974	56 new
	30 W	300-900 mA	750 mA	167x41x32 mm	248998	63 new
DALI	12 W	100-400 mA	300 mA	135x30x20 mm	248967	34 new
	25 W	150-900 mA	500 mA	167x41x32 mm	248981	79 new
	36 W	200/1200 mA	700 mA	167x39x30 mm	249001	85 new

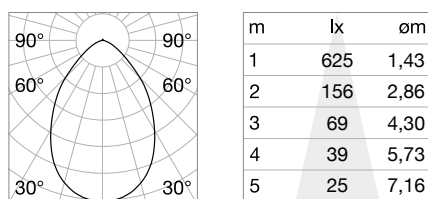

CRI≥80 10W 70° 1200 Lm 3000 K

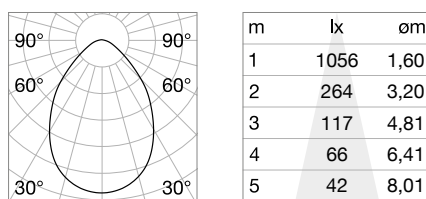

CRI≥80 20W 77° 2100 Lm 3000 K

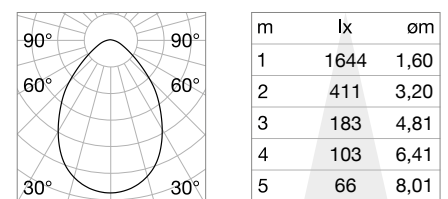

CRI≥80 30W 77° 3200 Lm 3000 K



Groove

IP20 CRI ≥80 30.000 h ALLUMINIO

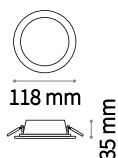

① 100 mm
0,220 Kg / 0,0012 m³

LED SMD AND DRIVER Incluso

Potenza	Angolo	Flux	CCT	Finitura	Codice	€
10 W	110°	890 Lm	3000 K	Bianco	123974	18
		1000 Lm	4000 K	Bianco	147666	18

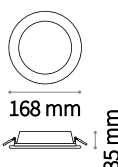

① 150 mm
0,410 Kg / 0,0023 m³

LED SMD AND DRIVER Incluso

Potenza	Angolo	Flux	CCT	Finitura	Codice	€
20 W	110°	1550 Lm	3000 K	Bianco	123998	24
		1750 Lm	4000 K	Bianco	147673	24

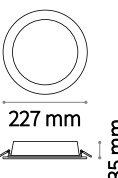

① 200 mm
0,660 Kg / 0,0036 m³

LED SMD AND DRIVER Incluso

Potenza	Angolo	Flux	CCT	Finitura	Codice	€
30 W	110°	2450 Lm	3000 K	Bianco	124018	30
		2800 Lm	4000 K	Bianco	147680	30

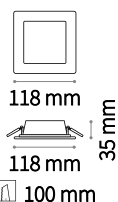

① 100 mm
0,270 Kg / 0,0012 m³

LED SMD AND DRIVER Incluso

Potenza	Angolo	Flux	CCT	Finitura	Codice	€
10 W	110°	890 Lm	3000 K	Bianco	123981	19

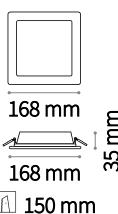

① 150 mm
0,540 Kg / 0,0023 m³

LED SMD AND DRIVER Incluso

Potenza	Angolo	Flux	CCT	Finitura	Codice	€
20 W	110°	1550 Lm	3000 K	Bianco	124001	26

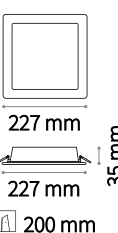

① 200 mm
0,850 Kg / 0,0036 m³

LED SMD AND DRIVER Incluso

Potenza	Angolo	Flux	CCT	Finitura	Codice	€
30 W	110°	2450 Lm	3000 K	Bianco	124025	33



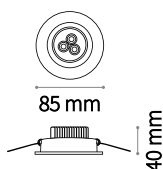

⌀ 70 mm

0,150 Kg / 0,0008 m³

LED COB AND DRIVER Incluso

Potenza	Angolo	Flux	CCT	Finitura	Codice	€
3 W	60°	240 Lm	3000 K	Bianco	247823	20 new
		270 Lm	4000 K	Bianco	062396	20

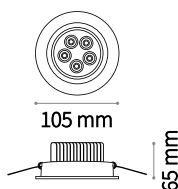

⌀ 90 mm

0,300 Kg / 0,0013 m³

LED COB AND DRIVER Incluso

Potenza	Angolo	Flux	CCT	Finitura	Codice	€
5 W	60°	400 Lm	3000 K	Bianco	247830	40 new
		450 Lm	4000 K	Bianco	062402	40





Eye

☐ IP20 CRI ≥80 30.000 h ALLUMINIO

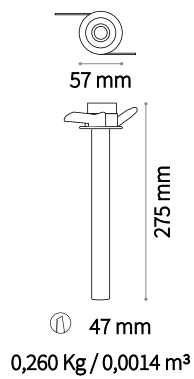

LED COB AND DRIVER Incluso

Potenza	Angolo	Flux	CCT	Finitura	Codice	€
2,5 W	15°	270 Lm	3000 K	Bianco	☐ 186986	68
				Nero	■ 186993	68



Zephyr

 IP20
  GESSO

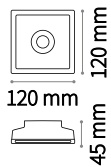

 120 mm
 0,880 Kg / 0,0032 m³

GU10 Non inclusa - Lampadina consigliata **224367**

Potenza	Finitura	Codice	€
max 35W	Bianco	 150284	15

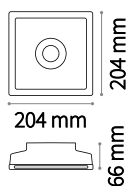

 204 mm
 1,350 Kg / 0,0075 m³

GU10 Non inclusa - Lampadina consigliata **224367**

Potenza	Finitura	Codice	€
max 35W	Bianco	 155722	50

Samba Round **new**

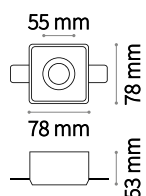

① 78 mm

0,036 Kg / 0,0016 m³

GU10 Non inclusa - Lampadina consigliata 224367

Potenza	Finitura	Codice	€
max 35W	Bianco	230580	12 new

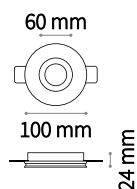

① 100 mm

0,230 Kg / 0,0018 m³

GU10 Non inclusa - Lampadina consigliata 224367

Potenza	Finitura	Codice	€
max 35W	Bianco	150307	10

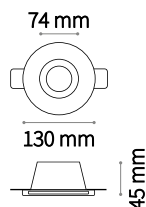

① 130 mm

0,450 Kg / 0,0032 m³

GU10 Non inclusa - Lampadina consigliata 224367

Potenza	Finitura	Codice	€
max 35W	Bianco	150130	12

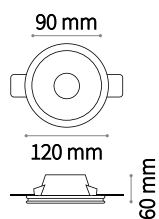

① 120 mm

0,340 Kg / 0,0019 m³

GU10 Non inclusa - Lampadina consigliata 224367

Potenza	Finitura	Codice	€
max 50W	Bianco	139012	12

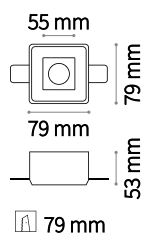

0,033 Kg / 0,0016 m³

GU10 Non inclusa - Lampadina consigliata 224367

Potenza	Finitura	Codice	€
max 35W	Bianco	229997	12 new

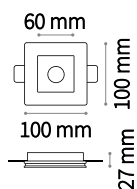

0,320 Kg / 0,0018 m³

GU10 Non inclusa - Lampadina consigliata 224367

Potenza	Finitura	Codice	€
max 35W	Bianco	150291	10

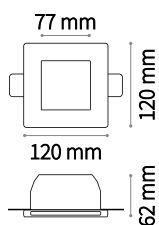

0,600 Kg / 0,0037 m³

GU10 Non inclusa - Lampadina consigliata 224367

Potenza	Finitura	Codice	€
max 35W	Bianco	150116	12

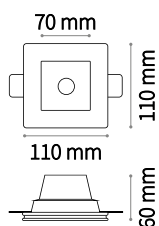

0,430 Kg / 0,0023 m³

GU10 Non inclusa - Lampadina consigliata 224367

Potenza	Finitura	Codice	€
max 50W	Bianco	139029	12

Jazz new

 IP20 ZINCO

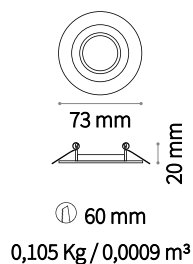

GU10 Non inclusa - Lampadina consigliata 123943

Potenza	Finitura	Codice	€
max 50W	Bianco	083117	7
	Brunito	083124	7
	Cromo	083070	7
	Nero	243818	7 <small>new</small>
	Nickel	083087	7

Swing new

 IP20 ZINCO

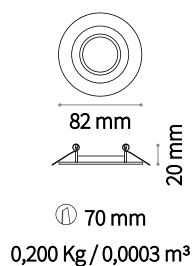

GU10 Non inclusa - Lampadina consigliata 123943

Potenza	Finitura	Codice	€
max 50W	Bianco	083179	9
	Brunito	083186	9
	Cromo	083131	9
	Nero	243825	9 <small>new</small>
	Nickel	083148	9

Lounge new

 IP20 ZINCO

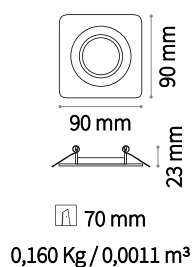

GU10 Non inclusa - Lampadina consigliata 123943

Potenza	Finitura	Codice	€
max 50W	Bianco	138978	12
	Cromo	138985	12
	Nero	244600	12 <small>new</small>
	Nickel	138992	12

Funky new

 IP20 FERRO

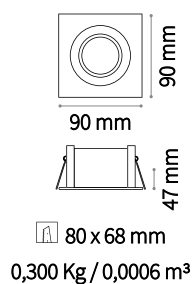

GU10 Non inclusa - Lampadina consigliata 123943

Potenza	Finitura	Codice	€
max 50W	Alluminio	083223	14
	Bianco	083230	14
	Brunito	083247	14
	Cromo	083193	14
	Nero	243849	14 <small>new</small>

Blues

 IP20 ALLUMINIO

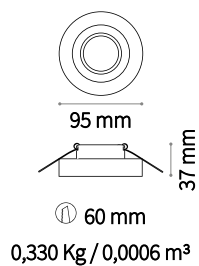

GU10 Non inclusa - Lampadina consigliata 123943

Potenza	Finitura	Codice	€
max 50W	Bianco	113999	19
	Fumè	113982	19
	Trasparente	083254	19

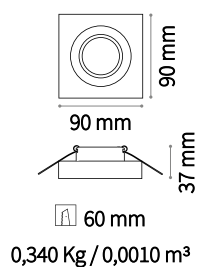

GU10 Non inclusa - Lampadina consigliata 123943

Potenza	Finitura	Codice	€
max 50W	Trasparente	114019	19

Soul

 IP20 CRISTALLO

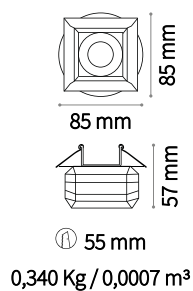

G9 Non inclusa - Lampadina consigliata 209043

Potenza	Finitura	Codice	€
max 40W	Trasparente	107691	16

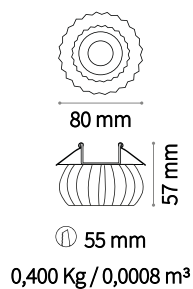

G9 Non inclusa - Lampadina consigliata 209043

Potenza	Finitura	Codice	€
max 40W	Trasparente	107707	16



200255

Glim **new**

Montatura interamente in metallo verniciato a polveri di colore bianco o nero. Diffusore orientabile con lampadina sostituibile.

LED Lampadine LED GU10 13W 3000 K incluse. Cod. 189031

200200

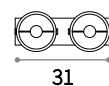
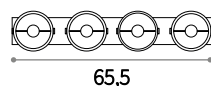
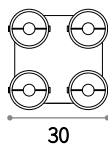
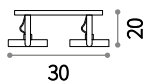

1,850 Kg / 0,0228 m³
GU10 max 4 x 50W

1,270 Kg / 0,0202 m³
GU10 max 4 x 50W

0,890 Kg / 0,0074 m³
GU10 max 2 x 50W

0,480 Kg / 0,0034 m³
GU10 max 1 x 50W

229638 € 220 **new**
229645 € 220 **new**

200217 € 210
200255 € 210

200200 € 105
200248 € 105

200194 € 55
200231 € 55



P. 646

 3000 K / 950 Lm
189031 € 14,50

 3000 K / 950 Lm
189031 € 14,50

 3000 K / 950 Lm
189031 € 14,50

 3000 K / 950 Lm
189031 € 14,50



229614

Glim Compact new

Montatura interamente in metallo verniciato a polveri di colore bianco o nero. Diffusore orientabile con lampadina sostituibile.

LED Lampadine LED GU10 7W 3000 K incluse. Cod. 123943

229560

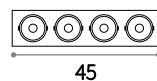
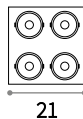
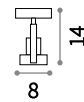
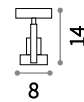
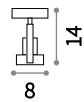
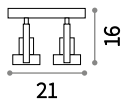

1,100 Kg / 0,0079 m³
GU10 max 4 x 50W

1,040 Kg / 0,0091 m³
GU10 max 4 x 50W

0,540 Kg / 0,0046 m³
GU10 max 2 x 50W

0,360 Kg / 0,0031 m³
GU10 max 1 x 50W

229614 ■ € 130 new
229621 ■ € 130 new

229591 ■ € 125 new
229607 ■ € 125 new

229577 ■ € 65 new
229584 ■ € 65 new

229553 ■ € 35 new
229560 ■ € 35 new



P. 646

3000 K / 640 Lm
123943 € 3,90

3000 K / 640 Lm
123943 € 3,90

3000 K / 640 Lm
123943 € 3,90

3000 K / 640 Lm
123943 € 3,90



Channel

Montatura in alluminio verniciato a polveri di colore nero. Orientabile in ogni direzione. Monta lampadine sostituibili GU10. Installazione senza incasso.

LED

Lampadine LED GU10 7W e LED GU10 13W 3000 K incluse.
Cod. 101378/189031

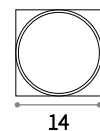
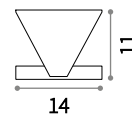



0,490 Kg / 0,0045 m³
GU10 max 1 x 13W

0,170 Kg / 0,0013 m³
GU10 max 1 x 7W

203140 ■ € 70

203133 ■ € 38

 3000 K / 950 Lm
189031 € 14,50

 3000 K / 560 Lm
101378 € 6,50



Halo

Base e corpo luce in alluminio verniciato a polveri. Diffusore in materiale plastico color opale. Sorgente luminosa a led integrati.

LED Sorgente luminosa LED 3000/4000 K, 35.000 h di durata.

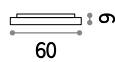

6,600 Kg / 0,0566 m³
LED 44W / 4300/5000 Lm
223223 ■ 3000K € 450
223230 ■ 4000K € 450

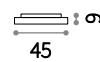

4,430 Kg / 0,0313 m³
LED 31W / 2800/3200 Lm
223209 ■ 3000K € 300
223216 ■ 4000K € 300



2,750 Kg / 0,0177 m³
LED 25W / 2200/2500 Lm
223186 ■ 3000K € 230
223193 ■ 4000K € 230





Polo

Rosone e montatura in metallo verniciato bianco opaco. Diffusore in policarbonato bianco opaco.

LED Sorgente luminosa LED 3000 K, 30.000 h di durata.

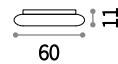

3,900 Kg / 0,0808 m³
LED 40W / 5600 Lm

140551 € 430

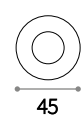
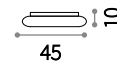

2,310 Kg / 0,0463 m³
LED 24W / 3050 Lm

140544 € 320

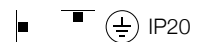
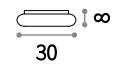

1,020 Kg / 0,0194 m³
LED 16W / 2050 Lm

140537 € 200





136998

Ufo **new**

Montatura in metallo verniciato bianco o nero opaco. Diffusore in materiale plastico bianco satinato con LED integrati.

LED Sorgente luminosa LED 3000 K, 30.000 h di durata.

205380

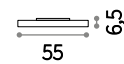

IP20

5,900 Kg / 0,0567 m³
LED 50W / 4050 Lm

136998 € 470
205410 € 470 **new**

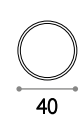
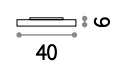

IP20

3,330 Kg / 0,0353 m³
LED 36W / 2900 Lm

137001 € 340
205380 € 340 **new**





Universal **new**

Montatura in metallo con finitura bianca.
Diffusore a led in materiale plastico.

LED Sorgente luminosa LED 3000 K,
17.500 h di durata.

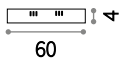

60



60



3,370 Kg / 0,0149 m³
LED 48W / 4080 Lm

240473 € 125 **new**

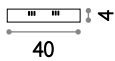

40



40



1,390 Kg / 0,0068 m³
LED 36W / 3060 Lm

240367 € 70 **new**

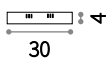

30



30



0,850 Kg / 0,0045 m³
LED 24W / 1400 Lm

138619 € 44

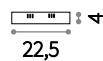

22,5



22,5



0,580 Kg / 0,0025 m³
LED 18W / 1050 Lm

138602 € 32

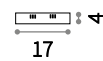

17



17



0,420 Kg / 0,0015 m³
LED 12W / 700 Lm

138596 € 25

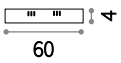

60



60

■ ■ ■ ■ ■ IP20

4,190 Kg / 0,0149 m³
LED 48W / 4080 Lm

240510 ■ € 125 new

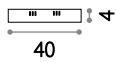

40



40

■ ■ ■ ■ ■ IP20

2,000 Kg / 0,0068 m³
LED 36W / 3060 Lm

240374 ■ € 70 new

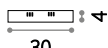

30



30

■ ■ ■ ■ ■ IP20

1,070 Kg / 0,0045 m³
LED 24W / 1400 Lm

138657 ■ € 44



22,5



22,5

■ ■ ■ ■ ■ IP20

0,710 Kg / 0,0025 m³
LED 18W / 1050 Lm

138640 ■ € 32



17



17

■ ■ ■ ■ ■ IP20

0,510 Kg / 0,0015 m³
LED 12W / 700 Lm

138633 ■ € 25





Look **new**

Base di fissaggio in alluminio tornito.
Diffusore cilindrico in metallo verniciato a
polveri bianco o nero o placcato cromo.

LED Lampadine LED GU10 7W 3000 K
includ. Cod. 101378



233352



233376



233321



P. 568



P. 650



P. 730

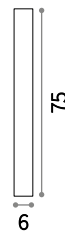

1,380 Kg / 0,0037 m³
GU10 max 1 x 28W

233352 € 55 **new**
233376 € 70 **new**
233321 € 55 **new**



0,740 Kg / 0,0025 m³
GU10 max 1 x 28W

233215 € 45 **new**
233222 € 50 **new**
233192 € 45 **new**



0,400 Kg / 0,0012 m³
GU10 max 1 x 28W

233079 € 35 **new**
233116 € 40 **new**
233062 € 35 **new**



3000 K / 560 Lm
101378 € 6,50



3000 K / 560 Lm
101378 € 6,50



3000 K / 560 Lm
101378 € 6,50



Sky **new**

Base di fissaggio in alluminio tornito.
Diffusore in metallo verniciato a polveri
bianco o nero.

LED Lampadine LED GU10 7W 3000 K
incluse. Cod. 101378



233970



P. 570

P. 650

P. 731

<p>1,940 Kg / 0,0047 m³ GU10 max 1x28W</p>	<p>1,090 Kg / 0,0027 m³ GU10 max 1x28W</p>	<p>0,600 Kg / 0,0016 m³ GU10 max 1x28W</p>
<p>234007 € 80 new 233970 € 80 new</p>	<p>233833 € 70 new 233826 € 70 new</p>	<p>233772 € 55 new 233765 € 55 new</p>
<p>3000 K / 560 Lm 101378 € 6,50</p>	<p>3000 K / 560 Lm 101378 € 6,50</p>	<p>3000 K / 560 Lm 101378 € 6,50</p>



Nitro

Corpo luce in alluminio verniciato bianco o nero opachi. Interno rifinito con mascherina in plastica. Sorgente luminosa a led integrato con lente.





















LED Sorgente luminosa LED 3000 K, 30.000 h di durata.

206035



206042



			
9	8	7,5	5,5
			
9	8	7,5	5,5
 IP20	 IP20	 IP20	 IP20
0,910 Kg / 0,0030 m ³ LED 15W / 1350 Lm	0,390 Kg / 0,0013 m ³ LED 10W / 900 Lm	0,400 Kg / 0,0013 m ³ LED 15W / 1350 Lm	0,230 Kg / 0,0005 m ³ LED 10W / 900 Lm
205977  € 70 205984  € 70	205991  € 52 206004  € 52	206011  € 62 206028  € 62	206035  € 44 206042  € 44



Mood new

Corpo luce in metallo disponibile con sezione quadra o tonda. Nero all'interno e alluminio, bianco o nero all'esterno. Diffusore interno orientabile.

 Lampadine alogene GU10 28W e GU10 50W 2700 K incluse.

140841

140865

243924

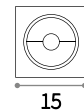
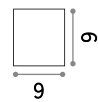
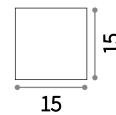
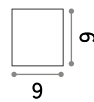
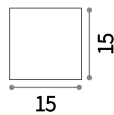

1,210 Kg / 0,0061 m³
GU10 max 1 x 50W

0,400 Kg / 0,0021 m³
GU10 max 1 x 28W

1,420 Kg / 0,0068 m³
GU10 max 1 x 50W

0,460 Kg / 0,0022 m³
GU10 max 1 x 28W

140872  € 69

140841  € 49

140933  € 69

140902  € 49

140896  € 69

140865  € 49

140957  € 69

140926  € 49

243450  € 69 new

243924  € 49 new

243931  € 69 new

243948  € 49 new

 3000 K / 950 Lm
189031 € 14,50

 3000 K / 640 Lm
123943 € 3,90

 3000 K / 950 Lm
189031 € 14,50

 3000 K / 640 Lm
123943 € 3,90



Oak

Corpo luce in gesso o cemento. Modello PL con elemento portalampada centrale orientabile.

 Articolo adatto alla pittura e verniciatura.

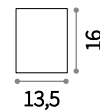

■ □ IP20

1,730 Kg / 0,0082 m³
GU10 max 1 x 35W

150420 □ € 70
150437 ■ € 70

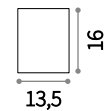

■ □ IP20

2,210 Kg / 0,0078 m³
GU10 max 1 x 35W

150468 □ € 70
150475 ■ € 70



P. 575

 3000 K / 400 Lm
108292 € 3,50

 3000 K / 400 Lm
108292 € 3,50

Tower

Base di fissaggio in materiale plastico con sistema a baionetta. Corpo luce interamente in gesso. Monta lampadine GU10 sostituibili.

 Articolo adatto alla pittura e verniciatura.



■  IP20

0,430 Kg / 0,0023 m³
GU10 max 1 x 35W

155869 ■ € 30



■  IP20

0,620 Kg / 0,0023 m³
GU10 max 1 x 35W

155791 ■ € 30

 3000 K / 400 Lm
108292 ■ € 3,50

 3000 K / 400 Lm
108292 ■ € 3,50

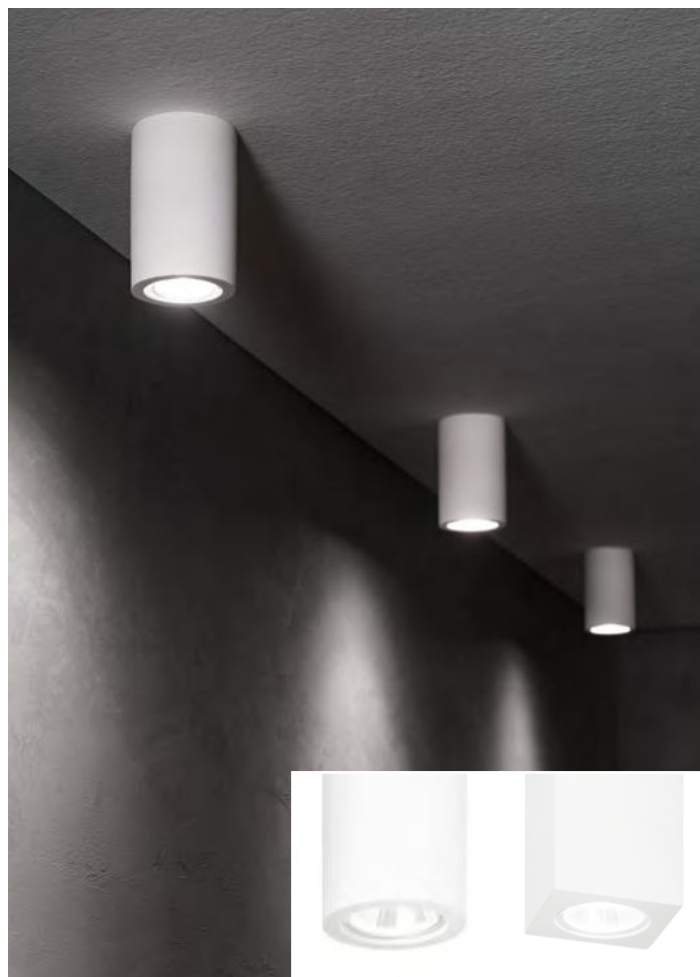

Kool ^{new}

Corpo luce interamente in vero cemento con supporto metallico interno.

LED Lampadine LED GU10 7W 3000 K incluse. Cod. 101378



■  IP20  INCLUSA

0,980 Kg / 0,0040 m³
GU10 max 1 x 7W

229874 ■ € 55 ^{new}

 3000 K / 560 Lm
101378 ■ € 6,50



P. 737





073583

Mouse

Base, montatura e diffusori in metallo rifinito con vernice opaca e dettagli in cromo. Diffusori orientabili. Disponibile nelle finiture bianco o nero.



156712

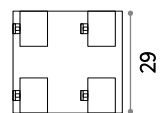
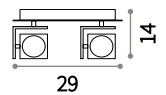

IP20

1,900 Kg / 0,0157 m³
GU10 max 4x50W

073583 € 196
156712 € 196



P. 648 P. 732

3000 K / 560 Lm
101378 € 6,50



156781

Spot

Base, montatura e diffusori in metallo rifinito con vernice opaca e dettagli in cromo. Diffusori orientabili. Disponibile nelle finiture bianco o nero.



156774

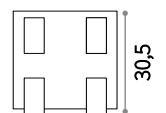
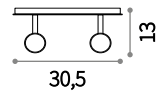

IP20

1,320 Kg / 0,0139 m³
GU10 max 4x50W

156774 € 80
156781 € 80



P. 648



P. 733



3000 K / 560 Lm
101378 € 6,50



229065

Rudy **new**

Montatura in alluminio pressofuso verniciato a polveri bianco o nero. Diffusori orientabili in rotazione e inclinazione.

LED Lampadine LED GU10 7W 3000 K incluse. Cod. 123943



229072

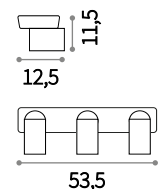
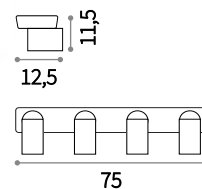

1,230 Kg / 0,0057 m³
GU10 max 4 x 35W

1,080 Kg / 0,0041 m³
GU10 max 3 x 35W

229089 € 145 **new**
229072 € 145 **new**

229065 € 100 **new**
229058 € 100 **new**



P. 734

722

3000 K / 640 Lm
123943 € 3,90

3000 K / 640 Lm
123943 € 3,90



Slide **new**

Montatura in metallo verniciato a polveri bianco, nero o placcato nickel. Diffusore orientabile. Cavo esterno rivestito da spirale metallica.

LED Lampadine LED GU10 7W 3000 K incluse. Cod. 123943

237022



237046

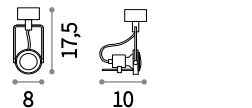

IP20 

0,350 Kg / 0,0029 m³
GU10 max 1 x 50W

237046 € 35 **new**
237022 € 35 **new**
237039 € 35 **new**



P. 647

 3000 K / 640 Lm
123943 € 3,90

Tecnico

Lampade da parete



Edgar 726



Riflesso 727



Flap 728



Cover 729



Look 730



SKY 731



Mouse 732



Spot 733



Rudy 734



Brick 735



Matt 735



Cube 736



Hydro 737



Kool 737



Click 738



Lola 739



Bright 739



Desk 740



Zig Zag 741



Flash Gesso 742



Foglio 743



Gin 744



Whisky 744



Tonic 745



Soda 745



Walky 746



Walky 746



Walky 746



Virus 747



O-Line 747



O-Line 747

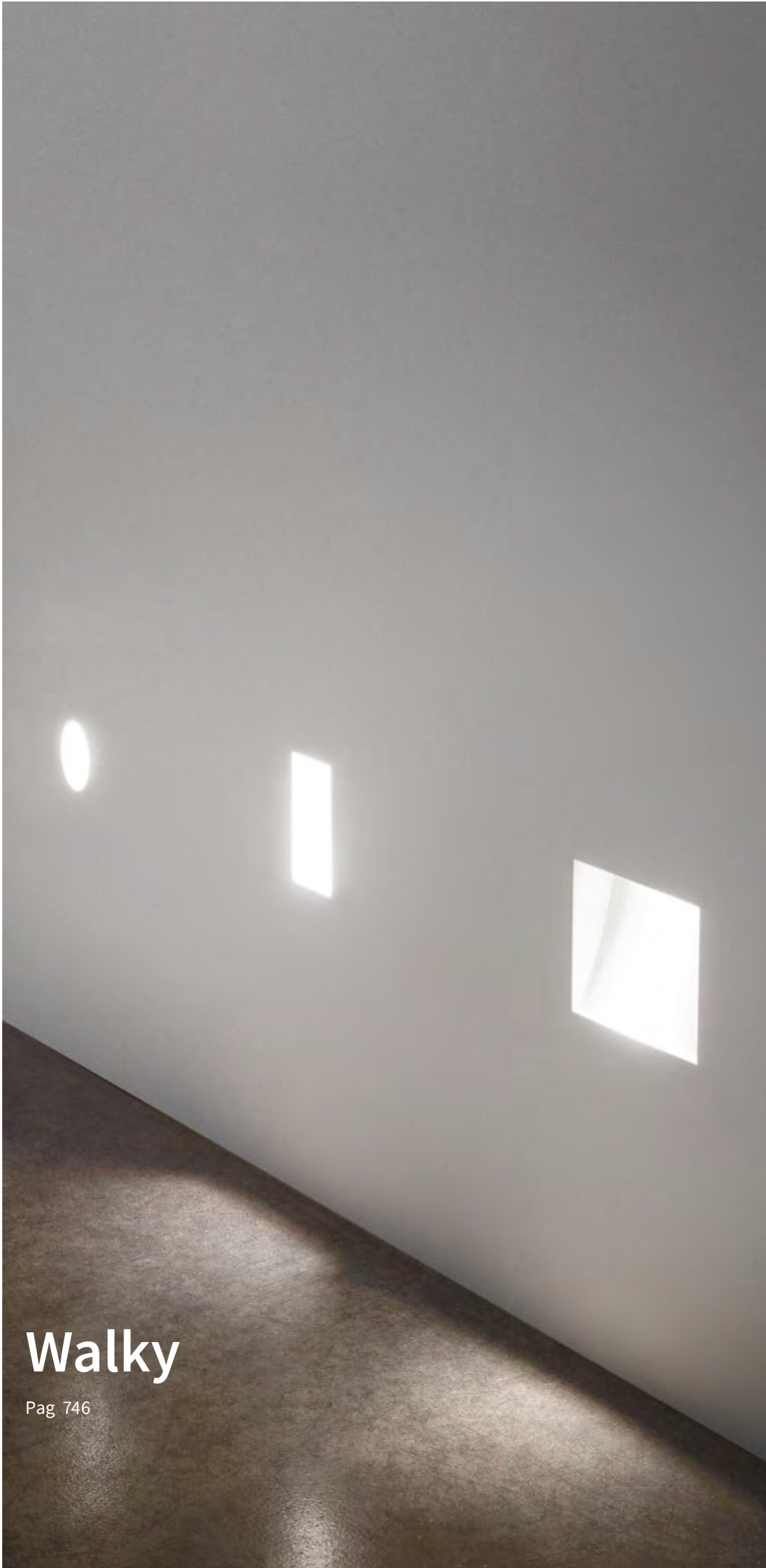

Walky

Pag 746





Edgar

Corpo luce in alluminio. Base sagomata per fissaggio diretto sul bordo superiore dello specchio. Alimentatore esterno e cavo a vista. Apparecchio impermeabile con IP44.

LED Sorgente luminosa LED 3000 K, 20.000 h di durata.

IP44 Grado di protezione IP44.

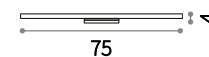
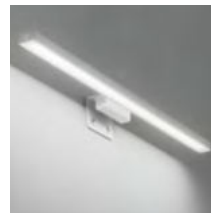

IP
5,5



0,680 Kg / 0,0055 m³
LED 12W / 800 Lm

136578 € 110

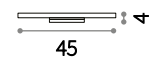

IP
5,5



0,590 Kg / 0,0033 m³
LED 6W / 400 Lm

136592 € 88



Riflesso

Montatura in metallo rifinito in cromo o vernice bianca opaca. Diffusore in materiale acrilico trasparente e satinato.

LED Sorgente luminosa LED 3000 K, 30.000 h di durata.

IP44 Grado di protezione IP44.



142296

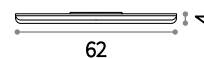

0,750 Kg / 0,0192 m³
LED 15,5W / 1350 Lm

142289 € 160
142265 € 160

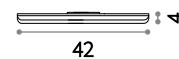

0,600 Kg / 0,0143 m³
LED 10W / 900 Lm

142296 € 120
142272 € 120



Flap

Montatura in metallo rifinito con vernice opaca di colore bianco. Diffusore ruotabile con schermo in acrilico opaco.

LED Sorgente luminosa LED 3000 K, 20.000 h di durata.

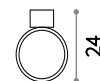
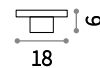

1,040 Kg / 0,0065 m³
LED 15W / 1200 Lm

155395 € 118

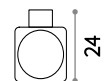
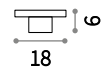

1,440 Kg / 0,0057 m³
LED 15W / 1200 Lm

155418 € 132



Cover

Corpo luce in alluminio verniciato a polveri di colore bianco o nero. Diffusore in materiale plastico opale. Sorgente luminosa a led integrati con emissione di luce riflessa.

LED Sorgente luminosa LED 3000 K, 17.500 h di durata.

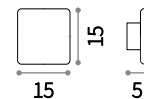
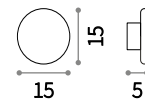
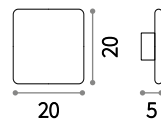
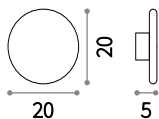

0,690 Kg / 0,0028 m³
LED 11W / 1100 Lm

0,860 Kg / 0,0028 m³
LED 9W / 1100 Lm

0,390 Kg / 0,0018 m³
LED 11W / 950 Lm

0,510 Kg / 0,0018 m³
LED 9W / 950 Lm

195711 € 80
195759 € 80

195735 € 80
195773 € 80

195704 € 68
195742 € 68

195728 € 68
195766 € 68



Look

Corpo luce in metallo con finitura rame, cromo, brunito o vernice opaca di colore bianco o nero.

 Lampadine alogene GU10 28W 2700 K incluse.

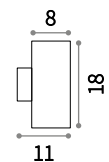

 IP20  INCLUSA

0,500 Kg / 0,0028 m³
GU10 max 2x28W

096018		€ 60
094182		€ 60
164847		€ 70
164823		€ 70
095998		€ 60

 3000 K / 400 Lm
108292 € 3,50





126883

Sky

Montatura in metallo con finiture: bianco, cromo, rame, nero, foglia argento e foglia oro.

 Lampadine alogene GU10 28W 2700 K incluse.

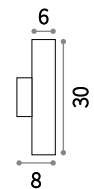
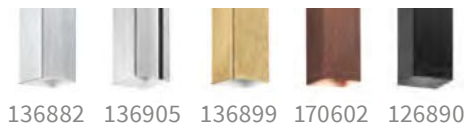

 IP20  INCLUSA

0,940 Kg / 0,0049 m³
GU10 max 2x28W

126883		€ 74
136905		€ 94
136882		€ 94
136899		€ 94
170602		€ 94
126890		€ 74

 3000 K / 400 Lm
108292 € 3,50



P. 570 P. 650 P. 715



Mouse

Base, montatura e diffusori in metallo rifinito con vernice opaca e dettagli in cromo. Diffusori orientabili. Disponibile nelle finiture bianco o nero.

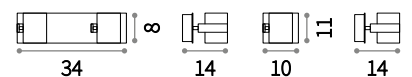

IP20

0,910 Kg / 0,0067 m³
GU10 max 2 x 50W

073545 € 96
156705 € 96

IP20

0,450 Kg / 0,0034 m³
GU10 max 1 x 50W

073521 € 50
073569 € 50

3000 K / 560 Lm
101378 € 6,50

3000 K / 560 Lm
101378 € 6,50



P. 648 P. 720



115481

Spot

Base, montatura e diffusori in metallo rifinito con vernice opaca e dettagli in cromo. Diffusori orientabili. Disponibile nelle finiture bianco o nero.



156736

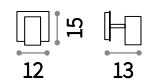
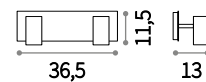

IP20

IP20

0,610 Kg / 0,0060 m³
GU10 max 2 x 50W

0,410 Kg / 0,0037 m³
GU10 max 1 x 50W

156736 € 40
156743 € 40

156729 € 24
115481 € 24



P. 648 P. 721

3000 K / 560 Lm
101378 € 6,50

3000 K / 560 Lm
101378 € 6,50

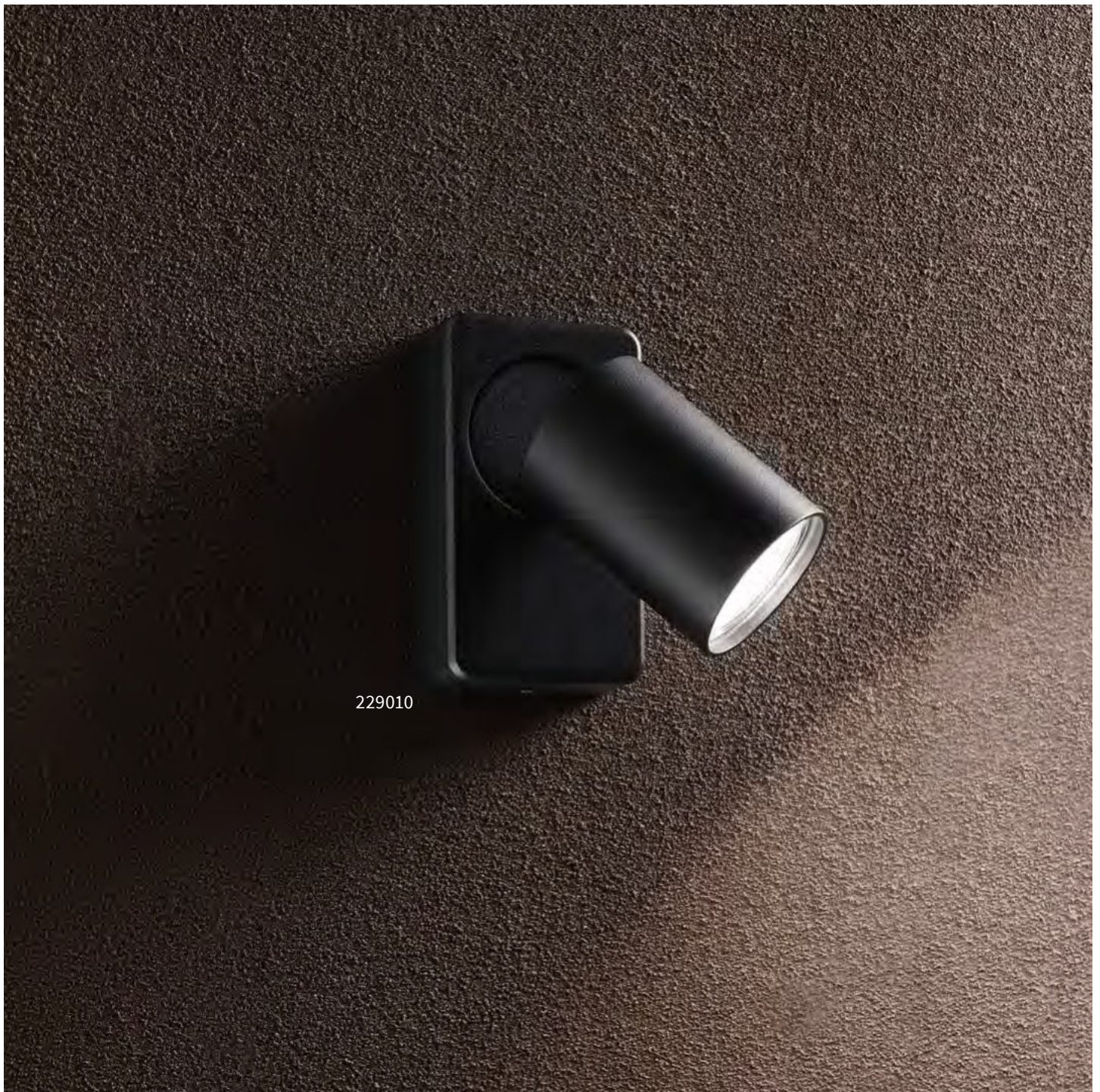

229010

Rudy **new**

Montatura in alluminio pressofuso verniciato a polveri bianco o nero. Diffusori orientabili in rotazione e inclinazione.

LED Lampadine LED GU10 7W 3000 K incluse. Cod. 123943



229041

<p>IP20 </p> <p>0,570 Kg / 0,0046 m³ GU10 max 2 x 35W</p> <p>229041 € 75 new 229034 € 75 new</p>	<p>IP20 </p> <p>0,270 Kg / 0,0016 m³ GU10 max 1 x 35W</p> <p>229027 € 40 new 229010 € 40 new</p>



P. 722

734

3000 K / 640 Lm
123943 € 3,90

3000 K / 640 Lm
123943 € 3,90

Brick

Corpo luce interamente in metallo rifinito bianco. Emissione luce verso l'alto.

LED Lampadine LED G9 3,2W 3000 K incluse. Cod. 209043

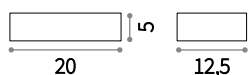

IP20

0,920 Kg / 0,0020 m³
G9 max 2 x 40W

104355 € 55

3000 K / 300 Lm
209043 € 3,50



Matt

Base di fissaggio in metallo verniciato. Corpo luce interamente in gesso. Emissione luce verso l'alto.

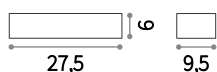

IP20

1,130 Kg / 0,0065 m³
E14 max 1 x 40W

155982 € 43

3000 K / 360 Lm
101231 € 3,00





Cube

Corpoluce dissipatore interamente in lastra d'alluminio da 6 mm di spessore. Rifinito con vernice a polveri. LED integrati.

LED Sorgente luminosa LED 3000 K, 25.000 h di durata.

60	30
10	10
IP20	IP20
1,390 Kg / 0,0055 m ³ LED 12W / 1200 Lm	0,800 Kg / 0,0028 m ³ LED 6W / 600 Lm
161792 ■ € 154	161785 ■ € 112

Hydro

Corpo luce interamente in vero cemento con supporto metallico interno.

LED Lampadine LED R7s 10W 118 mm
3000 K incluse. Cod. 189093

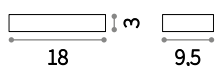

0,510 Kg / 0,0035 m³
R7s max 1 x 15W

139746 ■ € 66

 3000 K / 1200 Lm
189093 ■ € 17,00



Kool

Corpo luce interamente in vero cemento con supporto metallico interno.

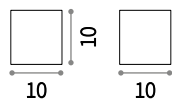
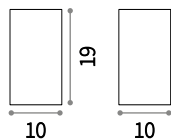



1,260 Kg / 0,0060 m³
GU10 max 2 x 15W

141275 ■ € 75

0,700 Kg / 0,0036 m³
G9 max 1 x 15W

141268 ■ € 50

 3000 K / 300 Lm
209043 ■ € 3,50

 3000 K / 300 Lm
209043 ■ € 3,50



P. 719





Click **new**

Corpo luce interamente in alluminio verniciato a polveri con finitura bianca o nera. Struttura interna che riflette il fascio luminoso sia sopra che sotto.

LED Sorgente luminosa LED 3000 K, 20.000 h di durata.



243191

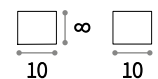
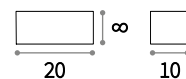

IP20

IP20

0,600 Kg / 0,0040 m³
LED 12W / 720 Lm

0,400 Kg / 0,0019 m³
LED 6W / 360 Lm

017518 € 70

051444 € 52

243184 € 70 **new**

243191 € 52 **new**

Lola

Corpoluce dissipatore interamente in lastra d'alluminio da 6 mm di spessore. Rifinito con vernice a polveri. LED integrati.

LED Sorgente luminosa LED 3000 K, 25.000 h di durata.

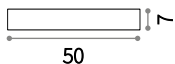

■ IP20

1,340 Kg / 0,0060 m³
LED 14W / 1100 Lm

162102 ■ € 184

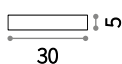

■ IP20

0,770 Kg / 0,0024 m³
LED 7W / 570 Lm

162089 ■ € 110



Bright

Corpo luce interamente in alluminio con finitura bianca. Fascio luminoso orientato sia verso l'alto che verso il basso.

LED Sorgente luminosa LED 3000 K, 30.000 h di durata.

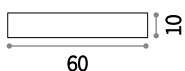

■ IP20

1,660 Kg / 0,0089 m³
LED 22,5W / 1500 Lm

131962 ■ € 172

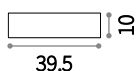

■ IP20

1,120 Kg / 0,0064 m³
LED 17W / 1100 Lm

134789 ■ € 127

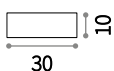

■ IP20

0,930 Kg / 0,0051 m³
LED 12W / 800 Lm

134796 ■ € 97





138251

Desk **new**

Corpo luce e rosone in alluminio rifinito con vernice a polveri color bianco o nero opaco.

LED Sorgente luminosa LED 3000 K, 30.000 h di durata.

173252

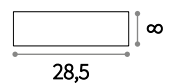

■  IP20

0,640 Kg / 0,0045 m³
LED 12W / 1100 Lm

138251  € 110

173252  € 110 **new**



P. 576



Zig Zag

Corpo luce dissipatore interamente in lastra d'alluminio da 6 mm di spessore. Rifinito con vernice a polveri di colore bianco o nero. LED integrati.

LED Sorgente luminosa LED 3000 K, 15.000 h di durata.



179292

179315

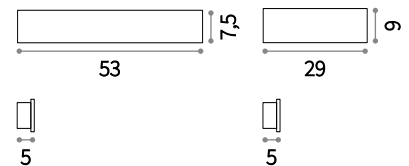

IP20

0,590 Kg / 0,0029 m³
LED 22W / 2100 Lm

179308 € 80
179322 € 80

IP20

0,450 Kg / 0,0020 m³
LED 12W / 1150 Lm

179292 € 68
179315 € 68



Flash Gesso

Base in metallo smaltato. Corpo luce interamente in gesso. Doppia emissione luminosa: sopra e sotto.

 Articolo adatto alla pittura e verniciatura.

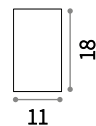

 IP20

0,710 Kg / 0,0049 m³
G9 max 1 x 40W

214689 € 40



 IP20

0,770 Kg / 0,0024 m³
G9 max 1 x 40W

214672 € 36

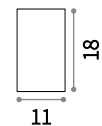



 IP20

0,950 Kg / 0,0034 m³
G9 max 1 x 40W

214696 € 35

 3000 K / 300 Lm
209043 € 3,50

 3000 K / 300 Lm
209043 € 3,50

 3000 K / 300 Lm
209043 € 3,50



Foglio

Articolo da incasso per finitura a scomparsa. Corpo luce interamente in gesso.



Articolo adatto alla pittura e verniciatura.

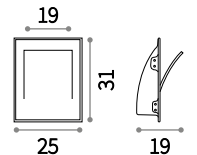

■ \oplus IP20

4,000 Kg / 0,0292 m³
E14 max 1 x 40W

150581 ■ € 96



3000 K / 360 Lm
101217 € 3,00

Gin

Corpo luce in gesso bianco. Base in metallo smaltato bianco. Emissione luce verso l'alto.

 Articolo adatto alla pittura e verniciatura.

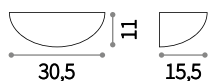

 IP20

3,220 Kg / 0,0151 m³
E14 max 1 x 40W

105741 € 35



 3000 K / 360 Lm
101217 € 3,00

Whisky

Corpo luce in gesso bianco. Base in metallo smaltato bianco. Diffusore inferiore in vetro trasparente satinato. Emissione luce sia sopra che sotto.

 Articolo adatto alla pittura e verniciatura.

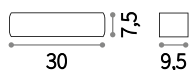

 IP20

1,100 Kg / 0,0068 m³
E14 max 1 x 40W

105710 € 50



 3000 K / 360 Lm
101217 € 3,00

Tonic

Corpo luce in gesso bianco. Base in metallo smaltato bianco. Diffusore inferiore in vetro trasparente satinato. Emissione luce sia sopra che sotto.

 Articolo adatto alla pittura e verniciatura.

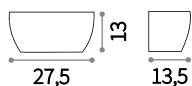

 IP20

3,250 Kg / 0,0150 m³
E14 max 1 x 40W

105734 € 55

 3000 K / 360 Lm
101217 € 3,00



Soda

Corpo luce in gesso bianco. Base in metallo smaltato bianco. Diffusore inferiore in vetro trasparente satinato. Emissione luce sia sopra che sotto.

 Articolo adatto alla pittura e verniciatura.



 IP20

2,630 Kg / 0,0154 m³
E14 max 2 x 40W

105727 € 80

 3000 K / 360 Lm
101217 € 3,00





Walky **new**

IP20
 CRI ≥90
 50.000 h
 GESSO

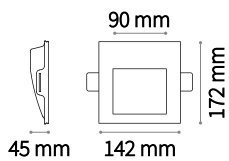

142 x 172 mm
 0,980 Kg / 0,0023 m³

LED SMD AND DRIVER Incluso

Potenza	Flux	CCT	Finitura	Codice	€
1 W	60 Lm	3000 K	Bianco	249810	55 new

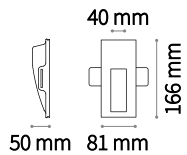

81 x 166 mm
 0,580 Kg / 0,0012 m³

LED SMD AND DRIVER Incluso

Potenza	Flux	CCT	Finitura	Codice	€
1 W	60 Lm	3000 K	Bianco	249827	55 new

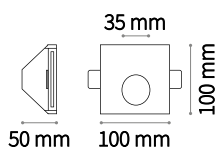

100 mm
 0,580 Kg / 0,0009 m³

LED SMD AND DRIVER Incluso

Potenza	Flux	CCT	Finitura	Codice	€
1 W	60 Lm	3000 K	Bianco	249834	55 new

Virus new

IP20 CRI ≥90 30.000 h ALLUMINIO



LED SMD AND DRIVER Incluso

Potenza	Angolo	Flux	CCT	Finitura	Codice	€
3 W	20°	210 Lm	3000 K	Bianco	+ 244808	25 <small>new</small>
				Oro	+ 244822	25 <small>new</small>
				Nero	+ 244846	25 <small>new</small>
				Oro	+ 244853	25 <small>new</small>



244808



244846

O-Line new

IP20 CRI ≥90 25.000 h ALLUMINIO



LED SMD AND DRIVER Incluso

Potenza	Flux	CCT	Finitura	Codice	€
3 W	210 Lm	3000 K	Bianco	239705	18 <small>new</small>

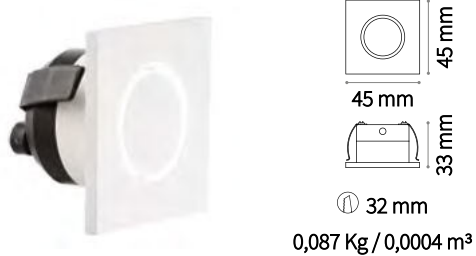

LED SMD AND DRIVER Incluso

Potenza	Flux	CCT	Finitura	Codice	€
3 W	210 Lm	3000 K	Bianco	239811	18 <small>new</small>

Esterno

Lampade da parete e soffitto



Clio 750



Clio 750



Clio 750



Sole 752



Fiesta 754



Clio 750



Clio 750



Clio 750



Clio 750



Clio 750



Clio 750



Luna 753



Gun 757



Sunglasses 758



Xeno 759



Cima 760



Anna 761



Style 762



Tronco 763



Terra 765



Minitommy 766



Tommy 767



Omega Round 768



Omega Square 769



Snif Round 770



Snif Square 771



Keope 774



Apollo 775



Pipeline 776



Base 776



Gun 777



Up 778



Rubik 779



Zeus 782



Down 783



Twin 784



Andromeda 785



Giove 786



Francy 787



Rex-1 788



Cometa 790



Mib 791



Mib 791



Lucia-1 792



Lucia-2 792



Maddi-1 793



Maddi-2 793



Bubble 753



Urano 756



Etere 764



Gas 764



Iko 772



Astro 773



Tetris-1 780



Tetris-2 781



Rex-2 789



Rex-3 789



Mike 793



Gun

Pag 757



Clio

Articolo componibile con montatura in alluminio estruso e tornito, rifinito con vernici a polveri di colore antracite, bianco, grigio e nero. Diffusore in materiale plastico bianco opaco.

IP44	IP44	IP44	0,540 Kg / 0,0171 m ³ E27 max 1 x 60W	0,520 Kg / 0,0144 m ³ E27 max 1 x 60W	0,610 Kg / 0,0231 m ³ E27 max 1 x 60W
148847 € 35 148854 € 35 148861 € 35 148878 € 35	146775 € 52 146782 € 52 145228 € 52 146799 € 52	144252 € 52 144238 € 52 136073 € 52 144245 € 52	145068 € 25	116716 € 25	145020 € 25

4000 K / 850 Lm
151991 € 2,50

4000 K / 850 Lm
151991 € 2,50

4000 K / 850 Lm
151991 € 2,50

144245

144252

136073

144238



P. 802



P. 802

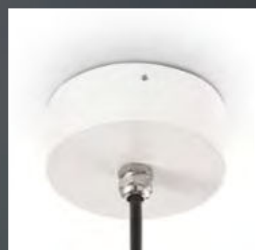



Sole

Diffusore in materiale plastico opale. Base sospensione in alluminio. Cavo elettrico in PVC.

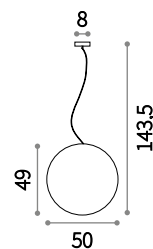

IP44

2,970 Kg / 0,1327 m³
E27 max 1 x 60W

136011 € 180

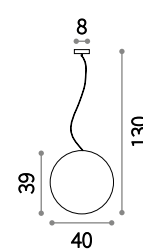

IP44

1,690 Kg / 0,0776 m³
E27 max 1 x 60W

136004 € 110

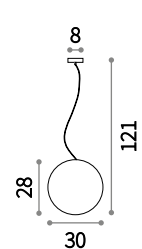

IP44

1,360 Kg / 0,0338 m³
E27 max 1 x 60W

135991 € 85



P. 797

4000 K / 1300 Lm
152004 € 6,50

4000 K / 1300 Lm
152004 € 6,50

4000 K / 1300 Lm
152004 € 6,50

Luna

Montatura in alluminio pressofuso e tornito rifinito con vernici a polveri.
Diffusore in materiale plastico opale.

LED

Lampadine LED G9 3,2W 4000 K
includi nel modello 213200.
Cod. 209036

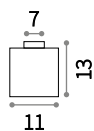
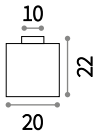

1,470 Kg / 0,0120 m³
E27 max 1 x 42W

0,400 Kg / 0,0021 m³
G9 max 1 x 5W

213194 € 98

213200 € 90



 4000 K / 850 Lm
151991 € 2,50

 4000 K / 320 Lm
209036 € 3,50

P. 798

Bubble

Montatura in alluminio pressofuso e tornito rifinito con vernici a polveri.
Diffusore in materiale plastico bianco opaco.

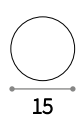
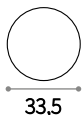
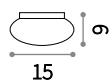
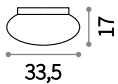



1,730 Kg / 0,0249 m³
E27 max 1 x 60W

0,480 Kg / 0,0031 m³
G9 max 2 x 15W

135250 € 95

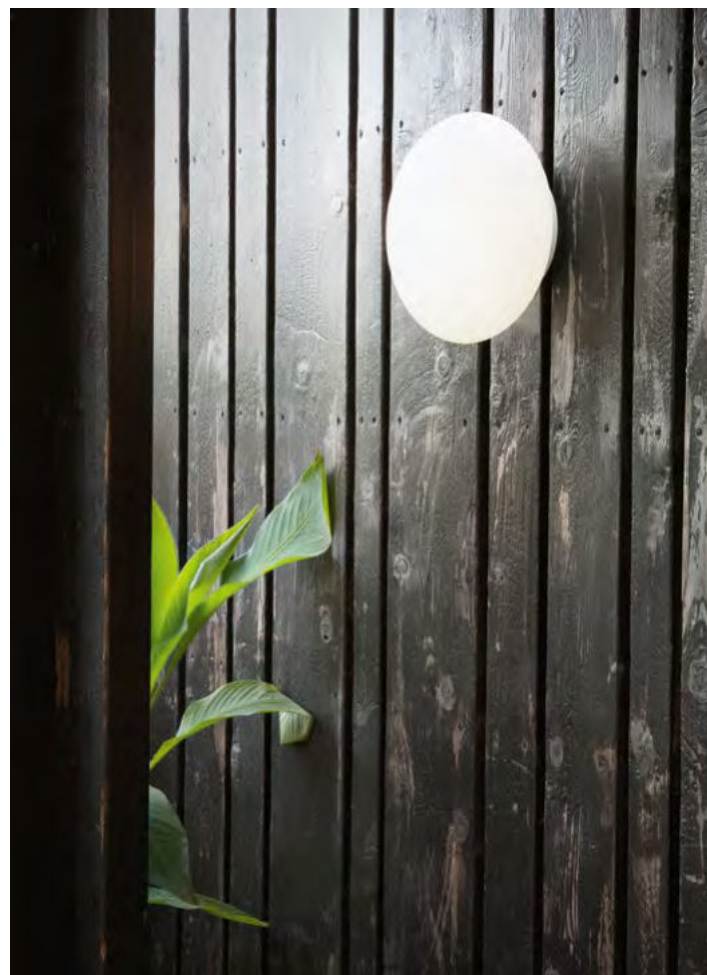
158907 € 55



 4000 K / 600 Lm
151960 € 2,50

 4000 K / 320 Lm
209036 € 3,50



Fiesta **new**

Cavo con portalampane e occhielli di ancoraggio in materiale plastico bianco o nero. Fornito con spina per esterni.



<p>605</p>	<p>303</p>
IP44	IP44
1,530 Kg / 0,0068 m ³ E27 max 10 x 15W	0,600 Kg / 0,0049 m ³ E27 max 5 x 15W
246802 € 85 new 246796 € 85 new	218724 € 48 159836 € 48

3000 K / 360 Lm
101286 € 3,00

3000 K / 360 Lm
101286 € 3,00





Urano

Corpo luce in alluminio tornito verniciato a polveri con finitura opaca antracite o bianca. Diffusore in materiale acrilico trasparente e satinato.

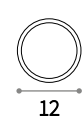
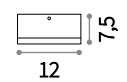
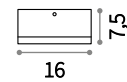

1,200 Kg / 0,0029 m³
GX53 max 1 x 15W

0,630 Kg / 0,0016 m³
GX53 max 1 x 15W

168050 € 64
168135 € 64

168036 € 46
168111 € 46

4000 K / 800 Lm
154008 € 5,90

4000 K / 800 Lm
154008 € 5,90



092324

Gun **new**

Corpo luce in alluminio con finitura naturale spazzolata o in vernice con varie finiture. Diffusore in vetro pirex trasparente.



163666

122663

163642

122687

236865

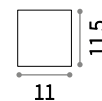

11

⊕ IP44

0,490 Kg / 0,0030 m³
GU10 max 1x28W

122663	€ 40
092324	€ 45
163642	€ 40
163666	€ 40
236865	€ 40 new
122687	€ 40

4000 K / 600 Lm
117652 € 6,50



P. 777



Sunglasses

Corpo luce in alluminio verniciato a polveri di colore antracite o bianco. Diffusori inclinabili con schermi in vetro trasparente.

LED Sorgente luminosa LED 4000 K, 25.000 h di durata.

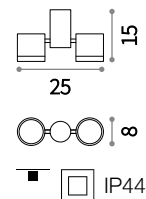

1,040 Kg/0,0040 m³
LED 14W/1120 Lm

161853 ■ € 90
161846 ■ € 90



129464

Xeno

Corpo luce in alluminio rifinito con vernice opaca a polveri. Diffusori orientabili con vetro temperato trasparente. Disponibile nelle finiture bianco, grigio o nero.



129518

129501

129495

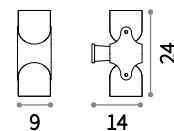

IP44

0,830 Kg / 0,0044 m³
GU10 max 2 x 28W

129495 € 52
129518 € 52
129501 € 52



IP44

0,360 Kg / 0,0014 m³
GU10 max 1 x 28W

129488 € 26
129471 € 26
129464 € 26

4000 K / 600 Lm
117652 € 6,50

4000 K / 600 Lm
117652 € 6,50



Cima **new**

Corpo luce interamente in alluminio pressofuso. Con finitura antracite, coffee o nero e oro. Diffusore in acrilico trasparente.

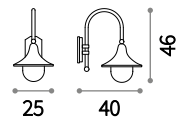

■  IP43

1,840 Kg / 0,0437 m³
E27 max 1x60W

246826 ■ € 45 **new**
246819 ■ € 45 **new**
024134 ■ € 45



P. 805

 4000 K / 920 Lm
153964 € 6,50



Anna

Corpo luce in resina ad alte prestazioni: inattaccabile dalla corrosione, colori stabilizzati da trattamento U.V., resistente a sbalzi termici da -60° C a +90° C. Diffusore in metacrilato antingiallimento.



101552

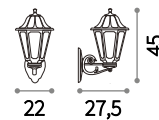

■ □ IP44

1,000 Kg / 0,0101 m³
E27 max 1 x 60W

120423 € 24
101491 € 24

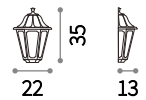

■ □ IP44

0,600 Kg / 0,0126 m³
E27 max 1 x 23W

120430 € 20
101552 € 20

4000 K / 920 Lm
153964 € 6,50

4000 K / 920 Lm
153964 € 6,50



P. 805



209845

Style **new**

Corpo luce in alluminio verniciato a polveri. Diffusore in materiale plastico opale. Sorgente luminosa a led integrato. Modello AP Sensor dotato di sensore PIR. Disponibile nelle finiture antracite o bianco.

LED Sorgente luminosa LED
3000/4000 K, 30.000 h di durata.



209852

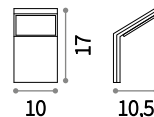

IP54

0,390 Kg / 0,0018 m³
LED 9W / 640/680 Lm

221502 ■ 4000K € 120
246857 ■ 3000K € 120 **new**
209845 ■ 4000K € 120

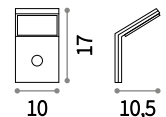

IP54

0,400 Kg / 0,0018 m³
LED 9,5W / 640/680 Lm

209852 ■ 4000K € 145
246864 ■ 3000K € 145 **new**
221519 ■ 4000K € 145



P. 809



118659

Tronco

Corpo luce in alluminio pressofuso rifinito in vernice di colore antracite, bianco, coffee, grigio o nero. Diffusore in vetro pirex con elementi interni in alluminio.



004716

027005

026979

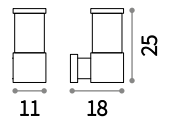

IP44

1,110 Kg / 0,0070 m³
E27 max 1x60W

118659	€ 50
026978	€ 50
027005	€ 50
004716	€ 50



P. 814

4000 K / 450 Lm
153957 € 2,90

Etere new

Corpo luce in fusione di alluminio verniciato a polveri. Diffusore in materiale plastico color opale. Disponibile nelle finiture antracite, bianco o coffee.

LED Sorgente luminosa LED
3000/4000 K, 25.000 h di durata.

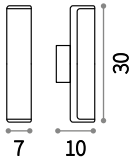

IP44

0,590 Kg / 0,0027 m³
LED 10,2W / 660/700 Lm

172347	4000K	€ 75
246949	4000K	€ 75 <small>new</small>
246925	3000K	€ 75 <small>new</small>
172408	4000K	€ 75



P. 819

172408



246949



172347



Gas new

Corpo luce in alluminio pressofuso verniciato a polveri. Diffusore in vetro temperato trasparente sabbato. Disponibile nelle finiture antracite, bianco, coffee o nero.

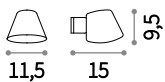

IP43

0,320 Kg / 0,0020 m³
GU10 max 1 x 28W

091518	€ 40
213095	€ 40 <small>new</small>
091525	€ 40
020228	€ 40

4000 K / 600 Lm
117652 € 6,50



P. 808

213095



091518



091525



020228





Terra ^{new}

Montatura in fusione d'alluminio verniciata. Corpo luce posizionabile. Diffusore in vetro pirex trasparente.

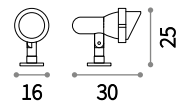

IP65

1,140 Kg / 0,0091 m³
E27 max 1 x 60W

247014 € 72 ^{new}
046167 € 72

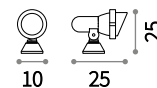

IP65

0,530 Kg / 0,0024 m³
GU10 max 1 x 35W

247021 € 37 ^{new}
046181 € 37

4000 K / 600 Lm
151960 € 2,50

4000 K / 600 Lm
117652 € 6,50



P. 829



Minitommy **new**

Corpo luce e diffusore in resina ad alte prestazioni: inattaccabile dalla corrosione sia di agenti atmosferici che di fertilizzanti chimici, colori stabilizzati da trattamento U.V., resistente a sbalzi termici da -60° C a +90° C. Diffusore direzionabile.

LED Lampadine LED GU10 3,5W
3000/4000 K incluse.

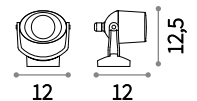

0,500 Kg / 0,0027 m³
GU10 max 1 x 6W

096483 ■ 4000K € 66
247182 ■ 3000K € 66 **new**
096476 ■ 4000K € 66



P. 830

123943 3000K € 3,90
224367 4000K € 3,90



Tommy ^{new}

Corpo luce e diffusore in resina ad alte prestazioni: inattaccabile dalla corrosione sia di agenti atmosferici sia di fertilizzanti chimici; colori stabilizzati da trattamento U.V.. Resistente a sbalzi termici da -60° C a +90° C. Diffusore direzionabile.

LED Lampadine LED GX53 7W
3000/4000 K incluse.

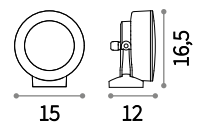

IP66 INCLUSA

0,690 Kg / 0,0044 m³
GX53 max 1 x 23W

145303	4000K	€ 72
145327	4000K	€ 72
247168	3000K	€ 72 ^{new}
145341	4000K	€ 72



P. 831

123936	3000K	€ 5,90
154008	4000K	€ 5,90



172538

Omega Round new

Corpo luce in alluminio verniciato a polveri. Diffusore inclinabile con schermo in materiale acrilico trasparente. Disponibile nelle finiture antracite, bianco, coffee o nero.

LED Sorgente luminosa LED
3000/4000 K, 25.000 h di durata.



172552

165387

247069

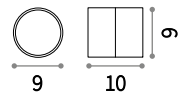

IP54

0,480 Kg / 0,0012 m³
LED 7,3W / 530/573 Lm

172538	4000K	€ 70
247069	4000K	€ 70 new
247076	3000K	€ 70 new
172552	4000K	€ 70
165387	4000K	€ 70



Omega Square

Corpo luce in alluminio verniciato a polveri. Diffusore inclinabile con schermo in materiale acrilico trasparente. Disponibile nelle finiture antracite, bianco o nero.

LED Sorgente luminosa LED 4000 K, 25.000 h di durata.

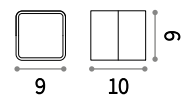

IP54

0,560 Kg / 0,0012 m³
LED 7,3W / 570 Lm

172507	■	€ 70
172514	■	€ 70
165370	■	€ 70



Snif Round

Corpo luce in alluminio pressofuso verniciato. Doppio diffusore, superiore e inferiore, in vetro pirex trasparente. Disponibile nelle finiture antracite, bianco, grigio o nero.

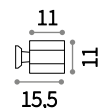

IP54

0,750 Kg / 0,0032 m³
G9 max 1 x 40W

144283	■	€ 48
061474	■	€ 48
061467	■	€ 48
061450	■	€ 48

4000 K / 320 Lm
209036 € 3,50



Snif Square

Corpo luce in alluminio pressofuso verniciato. Doppio diffusore, superiore e inferiore, in vetro pirex trasparente. Disponibile nelle finiture antracite, bianco, grigio o nero.

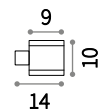

IP44

0,600 Kg / 0,0027 m³
G9 max 1 x 40W

144276	€ 40
118666	€ 40
121963	€ 40
123080	€ 40

4000 K / 320 Lm
209036 € 3,50



Iko

Corpo luce in alluminio pressofuso verniciato a polveri. Doppio diffusore, superiore e inferiore, in vetro temperato trasparente e sabbiato. Disponibile nelle finiture antracite, bianco o grigio.

018515



092218



018522

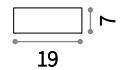

19



14

■  IP54

0,600 Kg / 0,0040 m³
E27 max 1x60W

018522  € 39

092218  € 39

018515  € 39

 4000 K / 600 Lm
151960 € 2,50



Astro

Corpo luce in alluminio pressofuso verniciato a polveri. diffusore, in vetro pirex trasparente sabbiato. Disponibile nelle finiture antracite o bianco.

092157



092164



■  IP44

0,310 Kg / 0,0012 m³
G9 max 1 x 25W

092164  € 30
092157  € 30

 4000 K / 320 Lm
209036 € 3,50



Keope

Corpo luce e diffusore in resina ad alte prestazioni: inattaccabile dalla corrosione di agenti atmosferici; colori stabilizzati da trattamento U.V.. Resistente a sbalzi termici da -60° C a +90° C. Diffusori in materiale acrilico trasparente satinato.

LED Lampadine LED GU10 3,5W 4000 K incluse.



147772



147796



147819

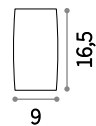
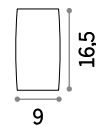

0,450 Kg / 0,0033 m³
GU10 max 2 x 6W

0,350 Kg / 0,0033 m³
GU10 max 1 x 6W

147772 € 50
147796 € 50
147819 € 50

147765 € 33

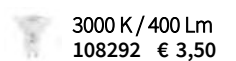
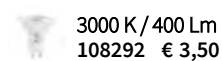



Apollo

Corpo luce in alluminio pressofuso rifinito con vernice opaca a polveri in colore bianco o nero. Emissione luce sopra e sotto.

LED Sorgente luminosa LED 4000 K, 25.000 h di durata.

137407



137391

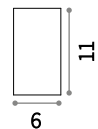

IP44

0,540 Kg / 0,0008 m³
LED 6W / 400 Lm

137407 € 60
137391 € 60

Pipeline

Corpo luce in metallo rifinito con vernice a polveri di colore nero. Diffusore con vetro trasparente.

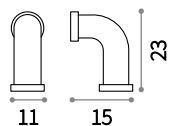

IP44

0,510 Kg / 0,0049 m³
GU10 max 1 x 35W

160559 ■ € 64

4000 K / 600 Lm
117652 € 6,50



Base

Corpo luce in alluminio pressofuso rifinito con vernice a polveri opaca di colore bianco, grigio o nero. Doppio diffusore, superiore e inferiore, in vetro temperato trasparente.

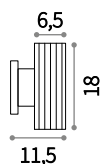

IP44

0,610 Kg / 0,0016 m³
GU10 max 2 x 28W

129457 ■ € 30
129440 ■ € 30
129433 ■ € 30

4000 K / 600 Lm
117652 € 6,50



129457



129440





Gun **new**

Corpo luce in alluminio con finitura naturale spazzolata o in vernice con varie finiture. Diffusore in vetro pirex trasparente disponibile a luce singola o doppia, superiore e inferiore.



P. 757



100395 236841 163628



033013 100388 163635

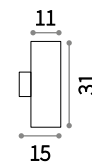

⊕ IP54

1,350 Kg / 0,0071 m³
E27 max 2 x 60W

092300 € 58
033020 € 64
163604 € 58
163611 € 58
236858 € 58 **new**
092317 € 58

💡 4000 K / 600 Lm
151960 € 2,50

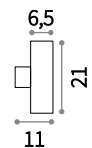

⊕ IP44

0,720 Kg / 0,0024 m³
GU10 max 2 x 35W

100388 € 50
033013 € 57
163628 € 50
163635 € 50
236841 € 50 **new**
100395 € 50

💡 4000 K / 600 Lm
117652 € 6,50





115313

Up

Corpo luce in fusione di alluminio verniciato a polveri. Diffusori in vetro pirex trasparente satinato. Disponibile nelle finiture antracite, bianco, coffee o nero.

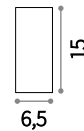

IP44

0,520 Kg / 0,0019 m³
G9 max 2 x 15W

115320 € 43
213354 € 43
115337 € 43
115344 € 43



IP44

0,320 Kg / 0,0012 m³
G9 max 1 x 15W

115290 € 29
213347 € 29
115306 € 29
115313 € 29

4000 K / 320 Lm
209036 € 3,50

4000 K / 320 Lm
209036 € 3,50



142302

Rubik new

Corpo luce in fusione di alluminio verniciato a polveri. Struttura interna che riflette il fascio luminoso sia sopra sia sotto. Disponibile nelle finiture antracite, bianco o nero.

LED Sorgente luminosa LED
3000/4000 K, 25.000 h di durata.



187341

187358

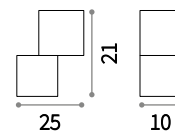

IP44

IP44

2,000 Kg / 0,0091 m³
LED 14W / 1150 Lm

0,660 Kg / 0,0022 m³
LED 7W / 630/670 Lm

187358	4000K € 165	149745	4000K € 100
187341	4000K € 165	247083	3000K € 100 new
180045	4000K € 165	149738	4000K € 100
		142302	4000K € 100





114293

Tetris-1 **new**

Corpo luce in alluminio rifinito con vernice opaca a polveri. Diffusore in vetro temperato trasparente. Disponibile nelle finiture antracite, bianco, coffee o grigio.



113753



113760



213323

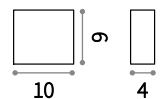

IP44

0,390 Kg / 0,0017 m³
G9 max 1 x 15W

114293	■	€ 63
113760	■	€ 63
213323	■	€ 63 new
113753	■	€ 63

4000 K / 320 Lm
209036 € 3,50



Tetris-2

Corpo luce in alluminio rifinito con vernice opaca a polveri di colore antracite.
Diffusore in vetro temperato trasparente.
Emissione luce sopra e sotto.

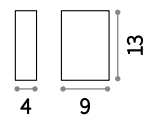

■  IP44

0,520 Kg / 0,0018 m³
G9 max 2 x 15W

113791 ■ € 67

 4000 K / 320 Lm
209036 € 3,50



Zeus

Corpo luce in alluminio grezzo spazzolato.
Diffusori orientabili con vetro temperato
trasparente e acidato.

LED Sorgente luminosa LED 4000 K,
30.000 h di durata.

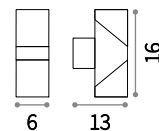

■ \oplus IP54

0,700 Kg / 0,0017 m³
LED 10W / 580 Lm

129532 ■ € 67

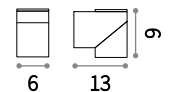

■ \oplus IP54

0,520 Kg / 0,0010 m³
LED 5W / 310 Lm

129525 ■ € 38



Down

Montatura in alluminio pressofuso verniciato a polveri con finitura antracite o bianca. Diffusore in acrilico.



122045



115382

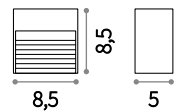

IP44

0,270 Kg / 0,0010 m³
G9 max 1 x 28W

115382 € 23
122045 € 23

4000 K / 320 Lm
209036 € 3,50



Twin **new**

Corpo luce in alluminio pressofuso verniciato a polveri di colore antracite, bianco, coffee o nero. Doppio diffusore, superiore e inferiore, in vetro pirex trasparente satinato.

LED Lampadine LED G9 3,2W 3000 K incluse nei modelli: 229552, 249346, 229539 e 229546. Cod. 209043



229522



249346



229546

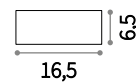

16,5



11,5



9



9



IP44



IP44

0,510 Kg / 0,0026 m³
G9 max 1 x 28W

0,370 Kg / 0,0013 m³
G9 max 1 x 15W

115351 € 40
213330 € 40 **new**
115368 € 40
115375 € 40

229522 € 38 **new**
249346 € 38 **new**
229539 € 38 **new**
229546 € 38 **new**

4000 K / 320 Lm
209036 € 3,50

3000 K / 300 Lm
209043 € 3,50



Andromeda

Corpo luce in alluminio pressofuso verniciato. Doppio diffusore, superiore e inferiore, in vetro pirex satinato. Disponibile nelle finiture antracite, bianco, coffee, grigio o nero.

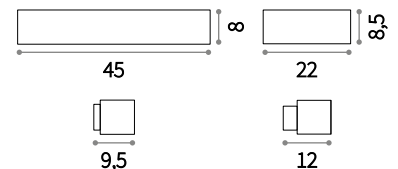

IP54

IP55

1,630 Kg / 0,0052 m³
E27 max 2 x 60W

1,000 Kg / 0,0045 m³
E27 max 1 x 60W

100364 € 66
163543 € 66
163550 € 66
092355 € 66
100371 € 66

066868 € 42
158822 € 42
163536 € 42
061580 € 42
061597 € 42

4000 K / 600 Lm
151960 € 2,50

4000 K / 600 Lm
151960 € 2,50



092195

Giove

Corpo luce in alluminio pressofuso verniciato a polveri. Doppio diffusore, superiore e inferiore, in vetro temperato trasparente sabbato. Disponibile nelle finiture antracite, bianco, coffee o nero.



092188



163598



092201

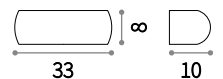

IP54

0,900 Kg / 0,0041 m³
E27 max 1x60W

092195	€ 50
163598	€ 50
092188	€ 50
092201	€ 50

4000 K / 600 Lm
151960 € 2,50



Francy

Corpo luce e diffusore in resina ad alte prestazioni: inattaccabile dalla corrosione sia di agenti atmosferici che di fertilizzanti chimici, colori stabilizzati da trattamento U.V., resistente a sbalzi termici da -60° C a +90° C.



123783



123769



123776

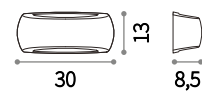

IP66

0,520 Kg / 0,0050 m³
E27 max 1 x 23W

123745 € 40

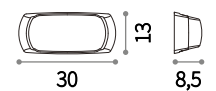

IP66

0,610 Kg / 0,0050 m³
E27 max 1 x 23W

123776 € 28
123769 € 28
123783 € 28

4000 K / 600 Lm
151960 € 2,50

4000 K / 600 Lm
151960 € 2,50

092393



Rex-1

Corpo luce in alluminio pressofuso verniciato a polveri di colore antracite, bianco o coffee. Diffusore bianco in materiale acrilico.

092409





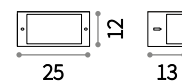

213217



■  IP44

0,600 Kg / 0,0065 m³
E27 max 1x60W

092393  € 33
213217  € 33
092409  € 33

 4000 K / 850 Lm
151991 € 2,50

Rex-2

Corpo luce in alluminio pressofuso verniciato a polveri di colore antracite o bianco. Diffusore bianco in materiale acrilico.

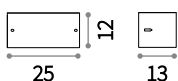

IP44

0,600 Kg / 0,0045 m³
E27 max 1 x 60W

092416 € 33
092423 € 33

4000 K / 850 Lm
151991 € 2,50



092423

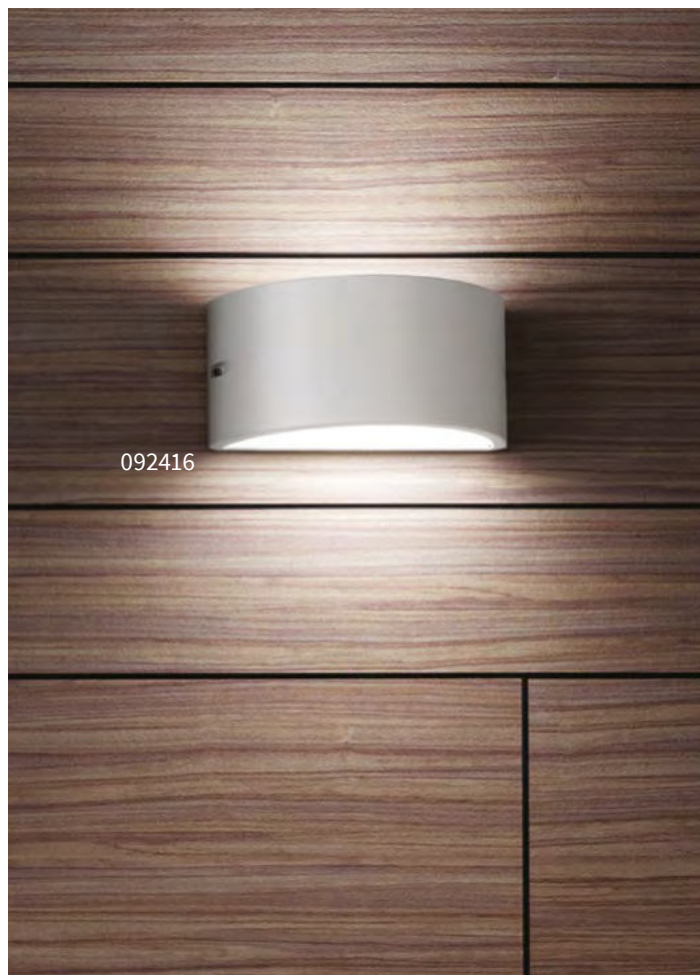

092416

Rex-3

Corpo luce in alluminio pressofuso verniciato a polveri di colore antracite o bianco. Diffusore bianco in materiale acrilico.

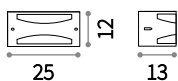

IP44

0,600 Kg / 0,0065 m³
E27 max 1 x 60W

092430 € 33
092447 € 33

4000 K / 850 Lm
151991 € 2,50



092447



092430



082240

Cometa

Corpo luce in alluminio pressofuso rifinito con vernice a polveri di colore antracite o nero. Diffusore in PVC bianco.



082271

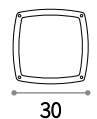
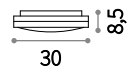

1,500 Kg / 0,0124 m³
E14 max 3x28W

082240 ■ € 76
082271 ■ € 76

 3000 K / 360 Lm
101217 € 3,00



Mib

Base in alluminio verniciato a polveri di colore bianco. Diffusore in materiale plastico opale. Sorgente luminosa a led integrati.

LED Sorgente luminosa LED 4000 K, 30.000 h di durata.

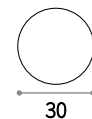
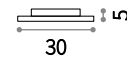

1,620 Kg / 0,0086 m³
LED 20W / 1200 Lm
202945 € 154

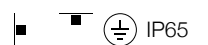
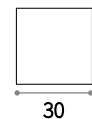
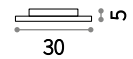

1,820 Kg / 0,0086 m³
LED 20W / 1200 Lm
202921 € 154





Lucia

Corpo luce e diffusore in resina ad alte prestazioni: inattaccabile dalla corrosione sia di agenti atmosferici che di fertilizzanti chimici, colori stabilizzati da trattamento U.V., resistente a sbalzi termici da -60° C a +90° C.



096681



096698

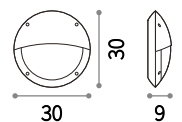
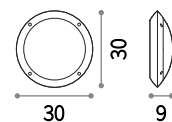

0,800 Kg / 0,0106 m³
E27 max 1 x 23W

0,800 Kg / 0,0106 m³
E27 max 1 x 23W

096667 € 24
096674 € 24

096681 € 17
096698 € 17

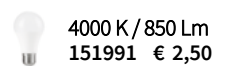
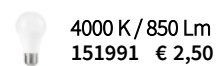

Maddi

Corpo luce e diffusore in resina ad alte prestazioni: inattaccabile dalla corrosione sia di agenti atmosferici che di fertilizzanti chimici, colori stabilizzati da trattamento U.V., resistente a sbalzi termici da -60° C a +90° C.

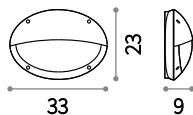
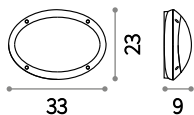

■ ■ ■ IP66

■ ■ ■ IP66

0,800 Kg / 0,0109 m³
E27 max 1 x 23W

0,800 Kg / 0,0109 m³
E27 max 1 x 23W

096711 ■ € 18
096704 ■ € 18

096735 ■ € 18
096728 ■ € 18

💡 4000 K / 850 Lm
151991 € 2,50

💡 4000 K / 850 Lm
151991 € 2,50



096728

096735

Mike

Corpo luce in blocco unico d'alluminio pressofuso rifinito antracite o bianco. Diffusore in vetro pirex.

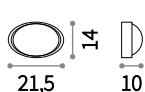
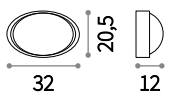

■ ■ ■ IP54

■ ■ ■ IP54

1,300 Kg / 0,0060 m³
E27 max 1 x 60W

0,690 Kg / 0,0055 m³
E27 max 1 x 25W

066882 ■ € 17
061818 ■ € 17

066899 ■ € 12
061788 ■ € 12

💡 4000 K / 850 Lm
151991 € 2,50

💡 4000 K / 850 Lm
151991 € 2,50



061788

066899

Esterno

Lampade da tavolo e terra



Doris 796



Sole 797



Luna 798



Sasso 799



BirilloOutdoor 799



Live 800



Live 800



Clio 802



Clio 802



Clio 802



ClassicGlobe 804



Cima 805



Anna 805



Tesla 806



Sirio 810



Acqua 811



Polaris 811



Amelia 812



Dema 813



Tronco 814



Pulsar 816



Edo Outdoor 820



Edo Outdoor 820



Elisa 821



Marte 822



Mercurio 823



Vega 824



Titano 825



Starlight 827



Zenith 828



Terra 829



Minitommy 830



Tommy 831



Inside 832



Krypton 833



Live 800



Jar 801



Itaca 801



Neos 807



Gas 808



Style 809



Venus 817



Torre 818



Etere 819



Zenith 828



Starlight

Pag 827



Doris

Diffusore in materiale plastico grigio melange effetto granito. Fornito con spina e picchetto per fissaggio nel terreno.

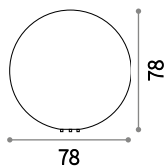

IP44

7,600 Kg / 0,5581 m³
E27 max 1 x 60W

195506 € 500

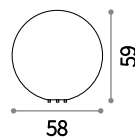

IP44

4,050 Kg / 0,2306 m³
E27 max 1 x 60W

195490 € 300

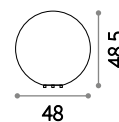

IP44

3,000 Kg / 0,1366 m³
E27 max 1 x 60W

195483 € 230

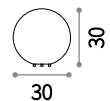

IP44

1,210 Kg / 0,0318 m³
E27 max 1 x 60W

214009 € 105

4000 K / 1300 Lm
152004 € 6,50

4000 K / 1300 Lm
152004 € 6,50

4000 K / 1300 Lm
152004 € 6,50

4000 K / 1300 Lm
152004 € 6,50



Sole

Diffusore in materiale plastico opale.
Fornito con spina e picchetto per terreno.
Base sospensione in alluminio.

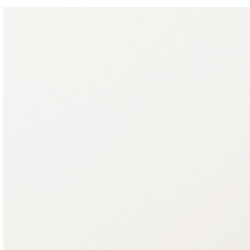

P. 752

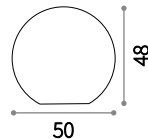

IP44

4,500 Kg / 0,1396 m³
E27 max 1 x 60W

191614 € 200

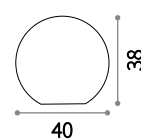

IP44

3,900 Kg / 0,0995 m³
E27 max 1 x 60W

191621 € 140

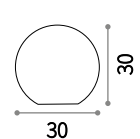

IP44

2,700 Kg / 0,0636 m³
E27 max 1 x 60W

191638 € 115

4000 K / 1300 Lm
152004 € 6,50

4000 K / 1300 Lm
152004 € 6,50

4000 K / 1300 Lm
152004 € 6,50



Luna

Diffusore in materiale plastico opale.
Fornito con spina e picchetto per terreno.

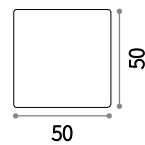

6,700 Kg / 0,1551 m³
E27 max 1x60W

191607 € 290

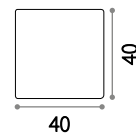

4,700 Kg / 0,0850 m³
E27 max 1x60W

191584 € 192

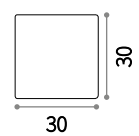

2,700 Kg / 0,0392 m³
E27 max 1x60W

191577 € 134



P. 753

4000 K / 1300 Lm
152004 € 6,50

4000 K / 1300 Lm
152004 € 6,50

4000 K / 1300 Lm
152004 € 6,50

Sasso

Diffusore in materiale plastico opale.
Fornito di cavo con spina e picchetto per
fissaggio a terra. Disponibile in versione
da parete.

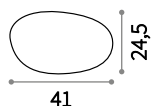

IP44
1,500 Kg / 0,0444 m³
E27 max 1 x 40W
161778 € 152

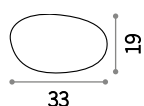

IP44
0,900 Kg / 0,0209 m³
E27 max 1 x 40W
161761 € 110

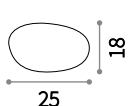

IP44
0,710 Kg / 0,0123 m³
G9 max 1 x 15W
161754 € 82

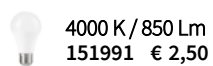

4000 K / 850 Lm
151991 € 2,50

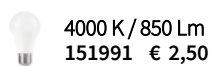

4000 K / 850 Lm
151991 € 2,50

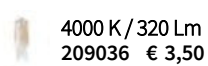

4000 K / 320 Lm
209036 € 3,50



Birillo Outdoor

Corpo luce-diffusore in materiale plastico
di colore bianco opaco. Fornito completo
di cavo e spina.

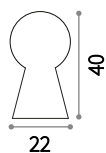

IP44
1,350 Kg / 0,0208 m³
E27 max 1 x 60W
131955 € 60

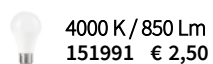

4000 K / 850 Lm
151991 € 2,50





138893

Live

Apparecchio mobile senza cavi, con led alimentati da batterie ricaricabili e luce a variazione di colore regolabile RGB. Corpo luce-diffusore in policarbonato bianco opaco. Autonomia batterie di 10 ore.

LED Sorgente luminosa LED 4000 K, 15.000 h di durata.

ON/OFF Lampada con interruttore integrato.

138886



138879



IP65
0,570 Kg / 0,0116 m³
LED 2,5W / 10 Lm

138886 ■ € 85



IP65
0,410 Kg / 0,0090 m³
LED 2,5W / 10 Lm

138893 ■ € 85

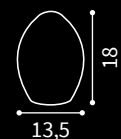

IP65
0,300 Kg / 0,0037 m³
LED 2,5W / 10 Lm

138879 ■ € 75

Itaca

Base e stelo in metallo verniciato a polveri di colore bianco. Diffusore conico in materiale plastico color opale. Fornito con spina.

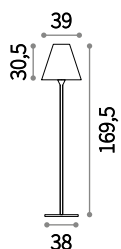

11,040 Kg / 0,1385 m³
E27 max 1 x 60W

180953 € 238

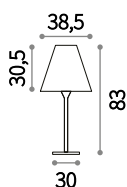

6,980 Kg / 0,1180 m³
E27 max 1 x 60W

180960 € 220

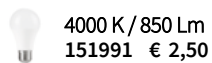
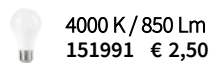

Jar

Corpo luce-diffusore in materiale plastico di colore bianco opaco. Fornito completo di cavo e spina.

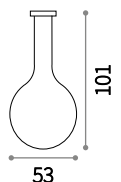

4,650 Kg / 0,2918 m³
E27 max 1 x 42W

205946 € 260

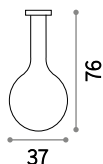

3,070 Kg / 0,1232 m³
E27 max 1 x 42W

205939 € 240

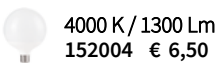
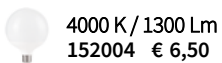

Clio

Articolo componibile con montatura in alluminio estruso e tornito, rifinito con vernici a polveri di colore antracite, bianco, grigio e nero. Diffusore in materiale plastico bianco opaco.

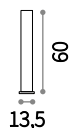

IP44

1,360 Kg / 0,0087 m³
E27 max 1 x 60W

249469 € 62
249476 € 62
249452 € 62
249483 € 62

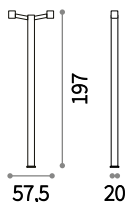

IP44

7,250 Kg / 0,0384 m³
E27 max 2 x 60W

249506 € 190
249513 € 190
249490 € 190
249520 € 190

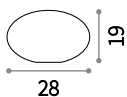

0,540 Kg / 0,0171 m³
145068 € 25

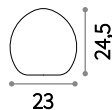

0,580 Kg / 0,0019 m³
116716 € 25

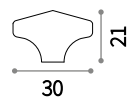

0,680 Kg / 0,0039 m³
145020 € 25

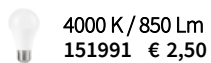
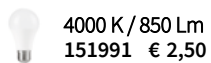



249506



P. 750



P. 750



P. 750



187532

Classic Globe

Corpo luce in resina resistente a corrosione, UV, a temperature da -60°a +90° C. Diffusore anti ingiallimento disponibile nelle finiture bianco o trasparente.



187525

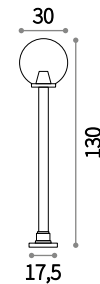

IP44

2,790 Kg / 0,1248 m³
E27 max 1 x 23W

187532 € 96
187525 € 96

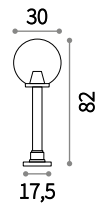

IP44

2,050 Kg / 0,1015 m³
E27 max 1 x 23W

187556 € 80
187549 € 80

4000 K / 850 Lm
151991 € 2,50

4000 K / 850 Lm
151991 € 2,50

Cima new

Corpo luce interamente in alluminio pressofuso. Con finitura antracite, coffee o nero e oro. Diffusore in acrilico trasparente.

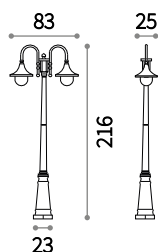

IP43

3,340 Kg / 0,1467 m³
E27 max 2 x 60W

246840 ■ € 225 new
246833 ■ € 225 new
024097 ■ € 225

4000 K / 920 Lm
153964 € 6,50



P. 760



246840 246833

Anna

Corpo luce in resina ad alte prestazioni: inattaccabile dalla corrosione, colori stabilizzati da trattamento U.V., resistente a sbalzi termici da -60° C a +90° C. Diffusore in metacrilato antingiallimento.

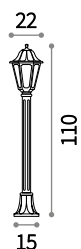

IP44

2,500 Kg / 0,0446 m³
E27 max 1 x 60W

120454 ■ € 65
101514 ■ € 65

4000 K / 920 Lm
153964 € 6,50



P. 761



101514



120454



153179

Tesla

Corpo luce in alluminio verniciato a polveri. Diffusore con schermo in materiale plastico bianco. Emissione luce verso il basso. Disponibile nelle finiture antracite o bianco.



153193

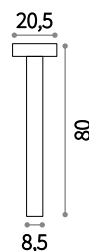

IP44

3,000 Kg / 0,0379 m³
G9 max 4 x 15W

153179 € 110
153162 € 110

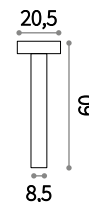

IP44

2,560 Kg / 0,0273 m³
G9 max 4 x 15W

153209 € 100
153193 € 100

4000 K / 320 Lm
209036 € 3,50

4000 K / 320 Lm
209036 € 3,50



247120

Neos **new**

Corpo luce in alluminio tornito verniciato a polveri. Diffusore inclinabile con vetro trasparente. Disponibile nelle finiture antracite, coffee o nero.

LED Sorgente luminosa LED
3000/4000 K, 25.000 h di durata.



247137

247113

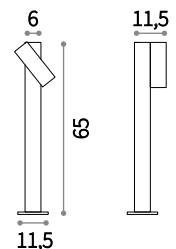

IP44

1,480 Kg / 0,0128 m³
LED 9,5W / 630/720 Lm

247113	■	3000K € 110	new
247106	■	4000K € 110	new
247120	■	3000K € 110	new
161907	■	4000K € 110	
247137	■	3000K € 110	new
161921	■	4000K € 110	



139470

Gas **new**

Corpo luce in alluminio pressofuso verniciato a polveri. Diffusore in vetro temperato trasparente sabbato. Disponibile nelle finiture antracite o coffee.



P. 764

213101

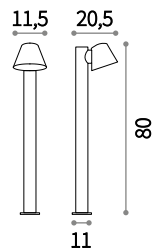

IP43

1,790 Kg / 0,0216 m³
GU10 max 1x35W

213101 € 95 **new**
139470 € 95

4000 K / 600 Lm
117652 € 6,50



Style **new**

Corpo luce in alluminio verniciato a polveri. Diffusore in materiale plastico opale. Sorgente luminosa a led integrato.

LED Sorgente luminosa LED
3000/4000 K, 30.000 h di durata.

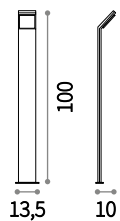

IP54

1,670 Kg / 0,0238 m³
LED 9W / 640/680 Lm

246871 ■ 3000K € 155 **new**
209906 ■ 4000K € 155



P. 762



115085

Sirio **new**

Corpo luce in alluminio verniciato a polveri. Diffusore in vetro pirex trasparente. Disponibile nelle finiture antracite, bianco, coffee, grigio o nero.

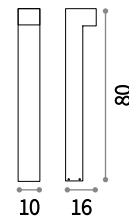

IP44

1,880 Kg / 0,0181 m³
G9 max 2 x 15W

115085 € 120
213262 € 120
246963 € 120 **new**
115061 € 120
115108 € 120

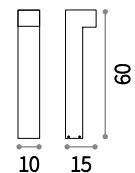

IP44

1,550 Kg / 0,0136 m³
G9 max 2 x 15W

115092 € 100
213279 € 100
246970 € 100 **new**
115078 € 100
115115 € 100

4000 K / 320 Lm
209036 € 3,50

4000 K / 320 Lm
209036 € 3,50

Acqua ^{new}

Corpo luce in alluminio tornito rifinito in vernice opaca con finitura antracite o coffee. Diffusore in vetro temperato.

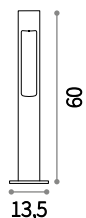

IP44

1,500 Kg / 0,0142 m³
G9 max 1x15W

246918 ■ € 125 ^{new}
135205 ■ € 125

4000 K / 320 Lm
209036 € 3,50



246918

Polaris

Corpo luce in alluminio verniciato a polveri di colore antracite. Diffusore in vetro pirex trasparente.

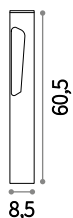

IP44

1,840 Kg / 0,0073 m³
G9 max 1x15W

115122 ■ € 116

4000 K / 320 Lm
209036 € 3,50





Amelia

Corpo luce e diffusore in resina ad alte prestazioni: anti corrosione, colori stabilizzati da trattamento U.V., resistente da -60° C a +90° C.

LED Lampadine LED E27 8W Goccia 4000 K incluse.

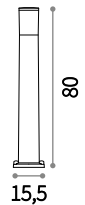

IP55
 1,070 Kg / 0,0220 m³
 E27 max 1x23W

198644 € 67
 198637 € 67
 198620 € 67

4000 K / 850 Lm
 151991 € 2,50



248226

Dema ^{new}

Corpo luce in alluminio verniciato a polveri con finitura antracite o nera. Diffusore in plexiglass trasparente con elementi interni in alluminio.

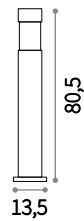

IP54

2,200 Kg / 0,0161 m³
R7s max 1 x 60W

248219 ■ € 120 *new*
248202 ■ € 120 *new*

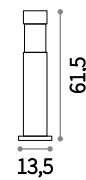

IP54

1,670 Kg / 0,0226 m³
R7s max 1 x 60W

243481 ■ € 110 *new*
248226 ■ € 110 *new*

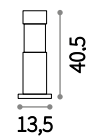

IP54

1,320 Kg / 0,0083 m³
R7s max 1 x 60W

248233 ■ € 100 *new*
248240 ■ € 100 *new*

4000 K / 1300 Lm
253480 € 17,00

4000 K / 1300 Lm
253480 € 17,00

4000 K / 1300 Lm
253480 € 17,00

Tronco **new**

Corpo luce in alluminio pressofuso rifinito in vernice di colore antracite, bianco, coffee, grigio o nero. Diffusore in vetro pirex con elementi interni in alluminio.

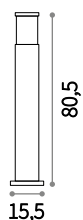

IP44

2,490 Kg / 0,0254 m³
E27 max 1 x 60W

109138 € 115
026961 € 115
163741 € 115
026992 € 115
004723 € 115

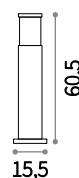

IP44

1,970 Kg / 0,0193 m³
E27 max 1 x 60W

109145 € 100
026954 € 100
163758 € 100
026985 € 100
004730 € 100

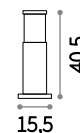

IP54

0,590 Kg / 0,0135 m³
E27 max 1 x 60W

248264 € 90 new
248288 € 90 new
248271 € 90 new
248257 € 90 new
248295 € 90 new

4000 K / 450 Lm
153957 € 2,90

4000 K / 450 Lm
153957 € 2,90

4000 K / 450 Lm
153957 € 2,90



P. 763





Pulsar new

Montatura in fusione d'alluminio verniciato a polveri di colore antracite, coffee o grigio. Diffusore in policarbonato bianco.

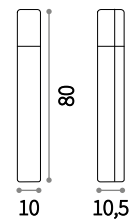

⏏ Ⓢ IP44

1,900 Kg / 0,0120 m³
E27 max 1x42W

135922 ☐ € 150
246888 ☐ € 150 new
135908 ☐ € 150

💡 4000 K / 850 Lm
151991 € 2,50



Venus

Corpo luce in lamina d'acciaio disponibile con finitura spazzolata o antracite. Elemento diffusore superiore in acrilico satinato.

LED Lampadine LED GU10 7W 4000 K incluse. Cod. 117652

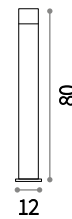

IP44 INCLUSA
 1,410 Kg / 0,0136 m³
 GU10 max 1 x 15W
 089775 € 80
 106175 € 80

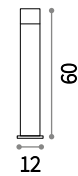

IP44 INCLUSA
 1,070 Kg / 0,0103 m³
 GU10 max 1 x 15W
 010892 € 70
 106182 € 70

4000 K / 600 Lm
 117652 € 6,50

4000 K / 600 Lm
 117652 € 6,50



Torre

Corpo luce in alluminio tornito verniciato a polveri con finitura antracite o nero. Diffusore in materiale plastico opale.

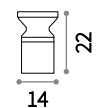
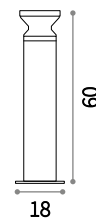

IP44

IP44

2,100 Kg / 0,0224 m³
E27 max 1 x 15W

0,870 Kg / 0,0054 m³
E27 max 1 x 15W

162492 € 104
186955 € 104

158891 € 83
186979 € 83

4000 K / 850 Lm
151991 € 2,50

4000 K / 850 Lm
151991 € 2,50



172439

Etere **new**

Corpo luce in fusione di alluminio verniciato a polveri. Diffusore in materiale plastico color opale. Disponibile nelle finiture antracite, bianco o coffee.

LED Sorgente luminosa LED 3000/4000 K, 25.000 h di durata.



P. 764



246956

172422

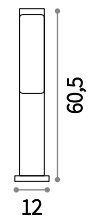

IP44

1,100 Kg / 0,0103 m³
LED 10,5W / 720/780 Lm

172422 4000K € 100
246956 4000K € 100 **new**
246932 3000K € 100 **new**
172439 4000K € 100



Edo Outdoor new

Montatura in fusione d'alluminio verniciato a polveri di colore antracite, bianco o coffee. Diffusore in policarbonato bianco.



138510



213071

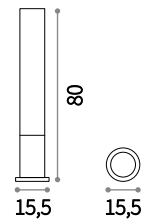

IP44

1,600 Kg / 0,0239 m³
GX53 max 1 x 15W

- 135755 € 95
- 213071 € 95 new
- 138510 € 95

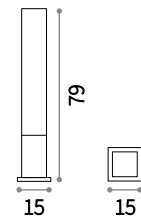

IP44

2,670 Kg / 0,0268 m³
GX53 max 1 x 15W

- 142999 € 95
- 213088 € 95 new
- 135762 € 95

4000 K / 800 Lm
154008 € 5,90

4000 K / 800 Lm
154008 € 5,90



187877

Elisa

Corpo luce in resina resistente a corrosione, UV, a temperature da -60°a +90° C. Diffusore trasparente anti ingiallimento.

LED Lampadine LED GX53 3W e LED GX53 7W 4000 K incluse.



187884

187891

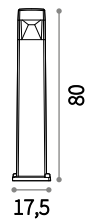

IP44

2,150 Kg / 0,0220 m³
GX53 max 1 x 23W

187877 € 86
187884 € 86
187891 € 86

4000 K / 800 Lm
154008 € 5,90



Marte

Corpo luce in alluminio verniciato a polveri con finitura antracite. Diffusore bianco in materiale acrilico.

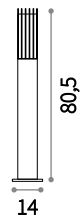

IP44

2,500 Kg / 0,0193 m³
E27 max 1x25W

092225 ■ € 130

4000 K / 850 Lm
151991 € 2,50



Mercurio

Corpo luce in alluminio verniciato a polveri con finitura antracite. Diffusore in vetro pirex trasparente.

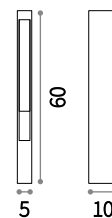

IP44

1,540 Kg / 0,0057 m³
G9 max 1 x 15W

114347 ■ € 130

4000 K / 320 Lm
209036 € 3,50

136059



Vega **new**

Corpo luce in alluminio con finitura in vernice opaca a polveri. Diffusore in vetro temperato trasparente. Disponibile nelle finiture antracite, bianco, coffee, grigio o nero.



136035

136042

213361

136028

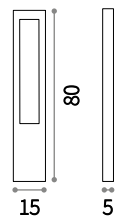

IP44

1,150 Kg / 0,0091 m³
G9 max 1 x 15W

136035 € 145
136042 € 145
213361 € 145 **new**
136028 € 145
136059 € 145

4000 K / 320 Lm
209036 € 3,50



Titano new

Corpoluce in resina porosa. Base e dettaglio diffusore in metallo verniciato nero opaco. Emissione luce verso il basso. LED integrato.

LED Sorgente luminosa LED
3000/4000 K, 50.000 h di durata.

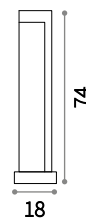

IP55

9,220 Kg / 0,0539 m³
LED 9W / 430/450 Lm

246987 ■ 3000K € 190 new
187327 ■ 4000K € 190

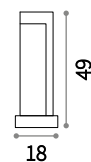

IP55

6,800 Kg / 0,0377 m³
LED 9W / 430/450 Lm

246994 ■ 3000K € 170 new
157856 ■ 4000K € 170



Starlight **new**

Proiettore orientabile in alluminio con fissaggio a plafone o con picchetto; superficie anodizzata e verniciata a polveri in grigio scuro; LED integrato ad efficienza energetica con elevata resa cromatica; disponibile in temperatura di colore 3000K e 4000K. Visiera antiabbagliamento in opzione.

LED Sorgente luminosa LED 3000/4000 K, 50.000 h di durata.

IP68 Grado di protezione IP68.

S316 Articolo in acciaio inox 316.

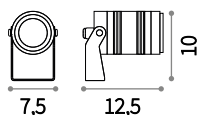

0,950 Kg / 0,0014 m³
LED 10W / 850/900 Lm

248387 ■ 3000K € 189 **new**
245072 ■ 4000K € 189 **new**

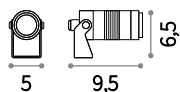

0,280 Kg / 0,0005 m³
LED 5,5W / 500/550 Lm

248394 ■ 3000K € 89 **new**
245041 ■ 4000K € 89 **new**

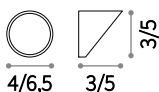

Non incluso
Optional

245096 ■ 5,5W € 25 **new**
245102 ■ 10W € 25 **new**

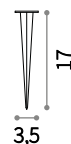

Non incluso
Optional

245089 € 15 **new**

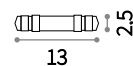

Non incluso
Necessario

248615 € 20 **new**







Zenith



Montatura in fusione d'alluminio verniciata a polveri con finitura antracite. Corpo luce posizionabile. Diffusore in materiale plastico.

LED Lampadine LED GU10 7W 4000 K incluse. Cod. 117652



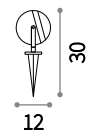

 IP65  INCLUSA
 1,080 Kg / 0,0137 m³
 GU10 max 1 x 11W
 124421 ■ € 72



 IP65  INCLUSA
 0,650 Kg / 0,0039 m³
 GU10 max 1 x 11W
 108407 ■ € 43

 4000 K / 600 Lm
 117652 € 6,50

 4000 K / 600 Lm
 117652 € 6,50



033037

Terra new

Montatura in fusione d'alluminio verniciata. Corpo luce posizionabile. Diffusore in vetro pirex trasparente.



163727

106205

046211

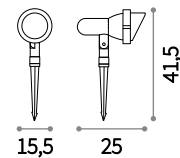

IP65

1,230 Kg / 0,0086 m³
E27 max 1 x 60W

247038 € 66 new
033044 € 66

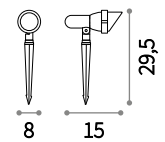

IP65

0,520 Kg / 0,0038 m³
GU10 max 1 x 35W

106205 € 40
163727 € 40
033037 € 40
046211 € 40

4000 K / 600 Lm
151960 € 2,50

4000 K / 600 Lm
117652 € 6,50



P. 765



120201

Minitommy new

Corpo luce e diffusore in resina ad alte prestazioni: inattaccabile dalla corrosione sia di agenti atmosferici che di fertilizzanti chimici, colori stabilizzati da trattamento U.V., resistente a sbalzi termici da -60° C a +90° C. Diffusore direzionabile.

LED Lampadine LED GU10 3,5W
3000/4000 K incluse.



120218

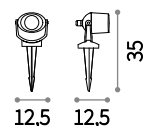

IP66  INCLUSA
0,360 Kg / 0,0027 m³
GU10 max 1 x 6W

120218	4000K	€ 66
247199	3000K	€ 66 new
120201	4000K	€ 66



P. 766

	123943	3000K	€ 3,90
	224367	4000K	€ 3,90



145303

Tommy **new**

Corpo luce e diffusore in resina ad alte prestazioni: inattaccabile dalla corrosione sia di agenti atmosferici sia di fertilizzanti chimici; colori stabilizzati da trattamento U.V.. Resistente a sbalzi termici da -60° C a +90° C. Diffusore direzionabile.

LED Lampadine LED GX53 7W
3000/4000 K incluse.



145327



145341

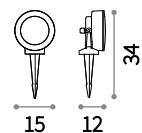

IP66 

0,730 Kg / 0,0044 m³
GX53 max 1 x 23W

145310	4000K	€ 72
145334	4000K	€ 72
247175	3000K	€ 72 new
145358	4000K	€ 72



P. 767

	123936	3000K	€ 5,90
	154008	4000K	€ 5,90



115429

Inside **new**

Montatura in fusione d'alluminio verniciato a polveri con finitura antracite, coffee o grigio. Corpo luce posizionabile. Diffusore in vetro pirex trasparente. Dotato di lancia da interrare.



115412

247045

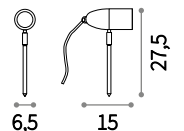

IP54

0,370 Kg / 0,0019 m³
G9 max 1 x 15W

247045 € 26 **new**
115412 € 26
115429 € 26

4000 K / 320 Lm
209036 € 3,50



Krypton

Corpo luce in acciaio spazzolato. LED integrati. Diffusore posizionabile per l'orientamento del flusso luminoso.

LED Sorgente luminosa LED 4000 K, 15.000 h di durata.

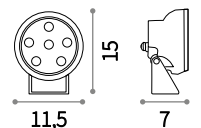

IP65

3,090 Kg / 0,0024 m³
LED 6W / 540 Lm

121970 ■ € 160

Esterno

Lampade a incasso



Park Round 836



Park Square 836



Park Led 837



Leti Round 838



Leti Square 838



Ceci Round 839



Ceci Square 839



Cecilia 840



Rocket Mini 842



Rocket Mini 842



Rocket Mini 842



Rocket-1 843



Rocket-2 843



Cecilia

Pag 840



Park

Spot da incasso al suolo o parete. Corpo luce esterno in PVC. Parabola riflettente in alluminio. Cornice blocca vetro in acciaio satinato. Vetro trasparente.

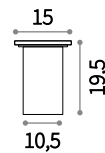

IP54

1,210 Kg / 0,0066 m³
E27 max 1 x 60W

032825 ■ € 64

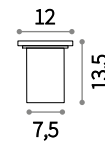

IP54

0,580 Kg / 0,0032 m³
GU10 max 1 x 20W

032832 ■ € 44

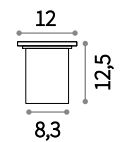

IP54

0,900 Kg / 0,0031 m³
G9 max 1 x 15W

117881 ■ € 70



4000 K / 920 Lm
153964 € 6,50



4000 K / 600 Lm
117652 € 6,50



4000 K / 320 Lm
209036 € 3,50



Park Led

Diffusore in vetro temperato trasparente. Calpestabile. Sorgente luminosa a led integrato. Assenza di viti a vista. Disponibile con due versioni di cassaforma ad altezza diversa per una maggiore versatilità d'installazione.

LED Sorgente luminosa LED 4000 K, 50.000 h di durata.

IP68 Grado di protezione IP68.

S316 Articolo in acciaio inox 316.

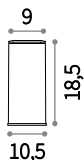

2,150 Kg / 0,0028 m³
LED 11,5W / 1100 Lm

222844 ■ 20° € 199
222851 ■ 60° € 199

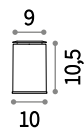

1,270 Kg / 0,0018 m³
LED 4,8W / 450 Lm

222868 ■ 15° € 139
222875 ■ 60° € 139

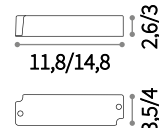

Driver
Non incluso
Necessario

226187 20W € 30
226194 35W € 40

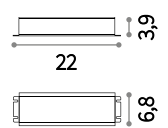

Driver
Non incluso
Necessario

226200 100W € 130
226217 185W € 150



Leti

Corpo luce e diffusore in resina ad alte prestazioni: inattaccabile dalla corrosione sia di agenti atmosferici che di fertilizzanti chimici, colori stabilizzati da trattamento U.V., resistente a sbalzi termici da -60° C a +90° C.

LED Lampadine LED GX53 3W 4000 K incluse.

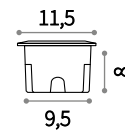
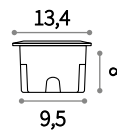

0,400 Kg / 0,0025 m³
GX53 max 1 x 23W

0,400 Kg / 0,0025 m³
GX53 max 1 x 23W

096544 € 29
096568 € 29
096551 € 29

096575 € 29
096599 € 29
096582 € 29



4000 K / 800 Lm
154008 € 5,90

4000 K / 800 Lm
154008 € 5,90



Ceci

Corpo luce e diffusore in resina ad alte prestazioni: inattaccabile dalla corrosione sia di agenti atmosferici che di fertilizzanti chimici, colori stabilizzati da trattamento U.V., resistente a sbalzi termici da -60° C a +90° C. Carrabile fino a 5000 Kg.

LED Lampadine LED GU10 3,5W e LED GX53 10W 4000 K incluse.

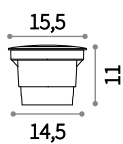

0,670 Kg / 0,0043 m³
GX53 max 1 x 23W
120324 ■ € 69

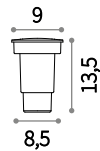

0,270 Kg / 0,0019 m³
GU10 max 1 x 6W
120249 ■ € 47

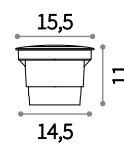

0,700 Kg / 0,0044 m³
GX53 max 1 x 23W
120386 ■ € 69

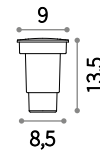

0,270 Kg / 0,0019 m³
GU10 max 1 x 6W
120317 ■ € 47

4000 K / 800 Lm
154008 € 5,90

4000 K / 420 Lm
253497 € 3,50

4000 K / 800 Lm
154008 € 5,90

4000 K / 420 Lm
253497 € 3,50

Cecilia

Corpo luce e diffusore in resina ad alte prestazioni: inattaccabile dalla corrosione sia di agenti atmosferici che di fertilizzanti chimici, colori stabilizzati da trattamento U.V., resistente a sbalzi termici da -60° C a +90° C. Carrabile fino a 5000 Kg.

LED Lampadine LED GU10 3,5W e LED GX53 10W 4000 K incluse.

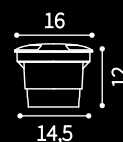

0,740 Kg / 0,0043 m³
GX53 max 1 x 23W

120362 ■ ■ € 100

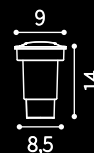

0,260 Kg / 0,0020 m³
GU10 max 1 x 6W

120287 ■ ■ € 66

 4000 K / 800 Lm
154008 € 5,90

 4000 K / 420 Lm
253497 € 3,50





Rocket Mini

Diffusore in vetro temperato trasparente. Calpestabile. Sorgente luminosa a led integrato. Assenza di viti a vista. Disponibile nelle versioni a 1, 2 luci in radenza pavimento oppure con unica luce centrale d'accento.

LED Sorgente luminosa LED 4000 K, 50.000 h di durata.

IP68 Grado di protezione IP68.

S316 Articolo in acciaio inox 316.

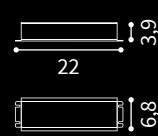
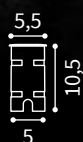

IP68
0,280 Kg / 0,0020 m³
LED 2W / 140 Lm

IP68
0,330 Kg / 0,0021 m³
LED 2W / 140 Lm

Driver
Non incluso
Necessario

Driver
Non incluso
Necessario

212623 ■ 15° € 74
212647 ■ 40° € 74

222820 ■ € 100
222837 ■ € 110

226187 20W € 30
226194 35W € 40

226200 100W € 130
226217 185W € 150



Rocket **new**

Apparecchio da incasso. Corpo luce in acciaio spazzolato. Diffusore in vetro pirex.

LED Sorgente luminosa LED
3000/4000 K, 50.000 h di durata.



122014



122021



IP65

0,560 Kg / 0,0034 m³
LED 3W / 270/290 Lm

247144 ■ 3000K € **105 new**
122014 ■ 4000K € **105**



IP65

0,560 Kg / 0,0034 m³
LED 3W / 270/290 Lm

247151 ■ 3000K € **105 new**
122021 ■ 4000K € **105**

Lampadine* e accessori



E14 846



E27 848



G4 855



G9 855



GU10 856



GX53 857



R7s 857



Strip 858



Kit Emergency 860



Chef 861



Ceiling Cups 862



Cables 862



Cables Holders 862







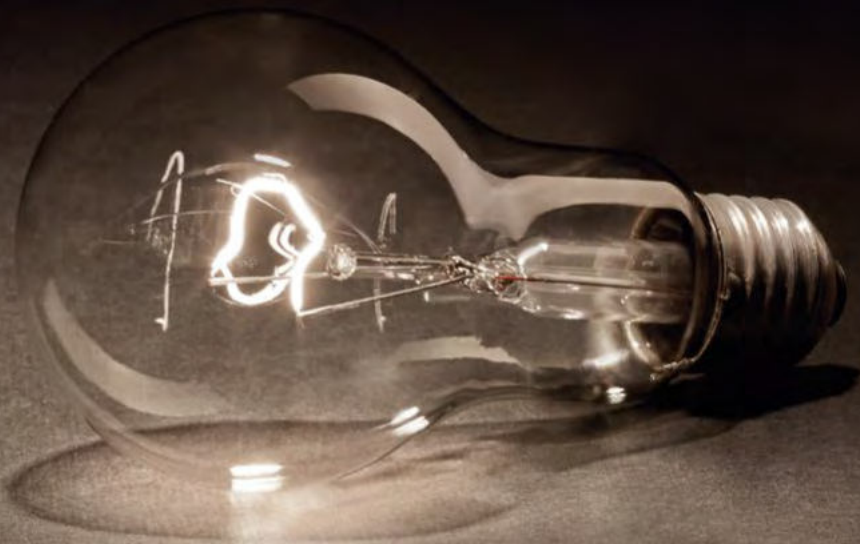





Bulb Holders 863

*Per le lampadine e strip led al prezzo indicato non sono applicabili ulteriori promozioni.



Lampadine E14



Lamp socket	Power	Flux	CCT	Life	Dimmable	Code	€	
	E14	4 W	430 Lm	3000 K	15.000 h	✓	188935	3,50
	E14	4 W	430 Lm	3000 K	15.000 h		101200	2,90
	E14	4 W	450 Lm	4000 K	15.000 h		153926	2,90
	E14	4 W	300 Lm	2200 K	15.000 h		151656	4,50
	E14	4 W	360 Lm	3000 K	15.000 h		101217	3,00
	E14	4 W	380 Lm	4000 K	15.000 h		253411	3,00 <small>new</small>
	E14	7 W	560 Lm	3000 K	25.000 h		151731	2,50
	E14	7 W	600 Lm	4000 K	25.000 h		151946	2,50
	E14	4 W	250 Lm	3000 K	15.000 h		101262	4,50
	E14	4 W	430 Lm	3000 K	15.000 h		101255	4,50
	E14	4 W	430 Lm	3000 K	15.000 h	✓	188911	3,50
	E14	4 W	430 Lm	3000 K	15.000 h		101248	2,90
	E14	4 W	450 Lm	4000 K	15.000 h		153940	2,90
	E14	4 W	300 Lm	2200 K	15.000 h		151663	4,50
	E14	4 W	360 Lm	3000 K	15.000 h		151793	3,00

101224 151748 151649





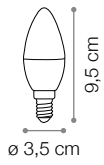
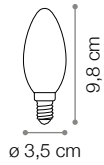
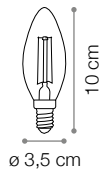
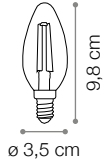





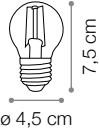





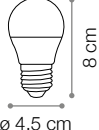

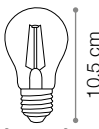
Lamp socket	Power	Flux	CCT	Life	Dimmable	Code	€
E14	4 W	430 Lm	3000 K	15.000 h	✓	188928	3,50
E14	4 W	430 Lm	3000 K	15.000 h		101224	2,90
E14	4 W	450 Lm	4000 K	15.000 h		153933	2,90
E14	4 W	300 Lm	2200 K	15.000 h		151649	4,50
E14	4 W	360 Lm	3000 K	15.000 h		101231	3,00
E14	7 W	560 Lm	3000 K	25.000 h		151748	2,50
E14	7 W	600 Lm	4000 K	25.000 h		151953	2,50



Lampadine E27

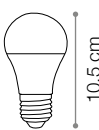

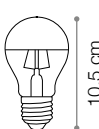
Lamp socket	Power	Flux	CCT	Life	Dimmable	Code	€		
		E27	4 W	430 Lm	3000 K	15.000 h	✓	188942	3,50
		E27	4 W	430 Lm	3000 K	15.000 h		101279	2,90
		E27	4 W	450 Lm	4000 K	15.000 h		153957	2,90
		E27	4 W	300 Lm	2200 K	15.000 h		151861	4,50
		E27	4 W	360 Lm	3000 K	15.000 h		101286	3,00
		E27	7 W	560 Lm	3000 K	25.000 h		151755	2,50
		E27	7 W	600 Lm	4000 K	25.000 h		151960	2,50
		E27	8 W	860 Lm	3000 K	15.000 h	✓	188973	6,90
		E27	4 W	430 Lm	3000 K	15.000 h		101293	2,90
		E27	4 W	450 Lm	4000 K	15.000 h		253428	2,90 <small>new</small>
		E27	8 W	860 Lm	3000 K	15.000 h		119571	6,50
		E27	8 W	920 Lm	4000 K	15.000 h		153964	6,50
		E27	4 W	300 Lm	2200 K	15.000 h		151687	4,90
		E27	8 W	810 Lm	3000 K	15.000 h	✓	252209	7,50 <small>new</small>
		E27	8 W	810 Lm	3000 K	15.000 h		123899	6,90
		E27	8 W	850 Lm	4000 K	15.000 h		253459	6,90 <small>new</small>
		E27	10 W	800 Lm	3000 K	25.000 h		151762	2,50
		E27	10 W	850 Lm	4000 K	25.000 h		151991	2,50
		E27	8 W	520 Lm	3000 K	15.000 h		123882	7,50



Lamp socket	Power	Flux	CCT	Life	Dimmable	Code	€
-------------	-------	------	-----	------	----------	------	---



E27	26 W	1850 Lm	3000 K	13.000 h		189147	16,00
-----	------	---------	--------	----------	--	---------------	--------------

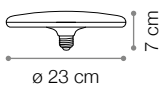

E27	35 W	3100 Lm	3000 K	13.000 h		189154	25,00
-----	------	---------	--------	----------	--	---------------	--------------

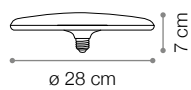

E27	48 W	4300 Lm	3000 K	13.000 h		189161	30,00
-----	------	---------	--------	----------	--	---------------	--------------

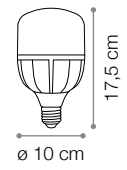

E27	30 W	2500 Lm	3000 K	20.000 h		189178	13,50
-----	------	---------	--------	----------	--	---------------	--------------



Lampadine E27



Lamp socket	Power	Flux	CCT	Life	Dimmable	Code	€
E27	8 W	860 Lm	3000 K	15.000 h	✓	188966	8,50
E27	8 W	860 Lm	3000 K	15.000 h		101323	7,90
E27	8 W	920 Lm	4000 K	15.000 h		153971	7,90
E27	4 W	300 Lm	2200 K	15.000 h	✓	223933	7,50
E27	4 W	300 Lm	2200 K	15.000 h		151717	6,90
E27	4 W	200 Lm	2200 K	15.000 h		204475	8,90
E27	8 W	720 Lm	3000 K	15.000 h	✓	252186	8,90 <i>new</i>
E27	8 W	720 Lm	3000 K	15.000 h		101330	8,50
E27	8 W	760 Lm	4000 K	15.000 h		253442	8,50 <i>new</i>
E27	12 W	960 Lm	3000 K	25.000 h		151779	5,50
E27	12 W	1020 Lm	4000 K	25.000 h		151977	5,50
E27	8 W	780 Lm	3000 K	20.000 h		157597	10,90
E27	8 W	520 Lm	3000 K	20.000 h		135526	10,90

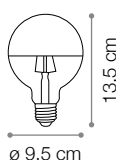
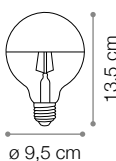
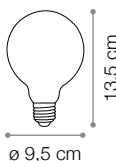
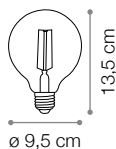
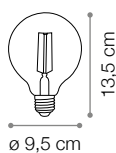
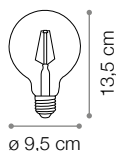

101347

151724

204468



Lamp socket	Power	Flux	CCT	Life	Dimmable	Code	€
-------------	-------	------	-----	------	----------	------	---

E27	8W	860 Lm	3000 K	15.000 h	✓	188959	9,50
-----	----	--------	--------	----------	---	---------------	-------------

E27	8 W	860 Lm	3000 K	15.000 h		101347	8,90
-----	-----	--------	--------	----------	--	---------------	-------------

E27	8 W	920 Lm	4000 K	15.000 h		153988	8,90
-----	-----	--------	--------	----------	--	---------------	-------------

E27	4 W	300 Lm	2200 K	15.000 h	✓	223926	8,50
-----	-----	--------	--------	----------	---	---------------	-------------

E27	4 W	300 Lm	2200 K	15.000 h		151724	7,90
-----	-----	--------	--------	----------	--	---------------	-------------

E27	4 W	200 Lm	2200 K	15.000 h		204468	9,90
-----	-----	--------	--------	----------	--	---------------	-------------

E27	8 W	720 Lm	3000 K	15.000 h		101354	9,00
-----	-----	--------	--------	----------	--	---------------	-------------

E27	8 W	760 Lm	4000 K	15.000 h		253435	9,00 <small>new</small>
-----	-----	--------	--------	----------	--	---------------	--------------------------------

E27	15 W	1200 Lm	3000 K	25.000 h		151786	6,50
-----	------	---------	--------	----------	--	---------------	-------------

E27	15 W	1300 Lm	4000 K	25.000 h		152004	6,50
-----	------	---------	--------	----------	--	---------------	-------------

E27	8 W	780 Lm	3000 K	20.000 h		157580	11,50
-----	-----	--------	--------	----------	--	---------------	--------------

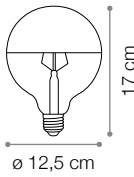
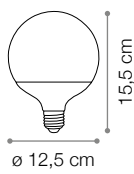
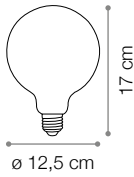
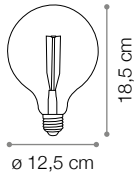
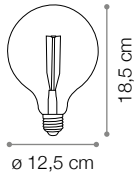
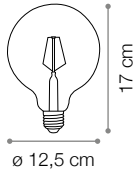

Lampadine E27



Lamp socket	Power	Flux	CCT	Life	Dimmable	Code	€
-------------	-------	------	-----	------	----------	------	---

		E27	4 W	300 Lm	2200 K	15.000 h		151700	4,50
		E27	4 W	380 Lm	2200 K	20.000 h		201283	5,50
		E27	4 W	380 Lm	2200 K	20.000 h		201269	9,90
		E27	4 W	380 Lm	2200 K	20.000 h		201290	11,90
		E27	4 W	380 Lm	2200 K	20.000 h		201276	11,90
		E27	6 W	400 Lm	2200 K	20.000 h		237350	18,00 <small>new</small>
		E27	6 W	200 Lm	2200 K	20.000 h		237367	20,00 <small>new</small>
		E27	4 W	300 Lm	2200 K	15.000 h	✓	223919	6,50
		E27	4 W	300 Lm	2200 K	15.000 h		151694	5,90
		E27	4 W	200 Lm	2200 K	15.000 h		204451	7,50

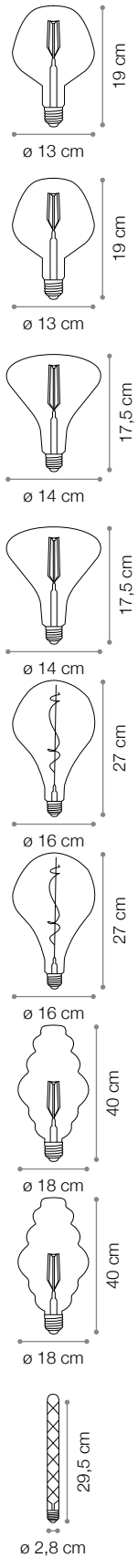

Lamp socket	Power	Flux	CCT	Life	Dimmable	Code	€
E27	6 W	400 Lm	2200 K	20.000 h		237374	18,00 <i>new</i>
E27	6 W	200 Lm	2200 K	20.000 h		237381	20,00 <i>new</i>
E27	6 W	400 Lm	2200 K	20.000 h		237336	18,00 <i>new</i>
E27	6 W	200 Lm	2200 K	20.000 h		237343	20,00 <i>new</i>
E27	4 W	200 Lm	2200 K	20.000 h		237251	25,00 <i>new</i>
E27	4 W	100 Lm	2200 K	20.000 h		237268	26,00 <i>new</i>
E27	12 W	800 Lm	2200 K	20.000 h		237299	70,00 <i>new</i>
E27	12 W	4000 Lm	2200 K	20.000 h		237305	80,00 <i>new</i>
E27	6 W	580 Lm	2200 K	20.000 h		201252	9,50



Lampadine E27



Lamp socket	Power	Flux	CCT	Life	Dimmable	Code	€
-------------	-------	------	-----	------	----------	------	---

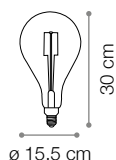

E27	8 W	600 Lm	2200 K	15.000 h	✓	223964	30,00
E27	8 W	600 Lm	2200 K	15.000 h		130163	28,00

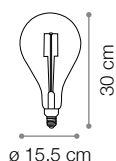

E27	8 W	400 Lm	2200 K	15.000 h		204543	30,00
-----	-----	--------	--------	----------	--	---------------	--------------

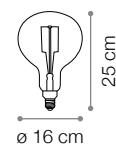

E27	4 W	320 Lm	2200 K	15.000 h	✓	223940	30,00
E27	4 W	320 Lm	2200 K	15.000 h		129877	28,00



E27	4 W	300 Lm	2200 K	15.000 h		204505	30,00
-----	-----	--------	--------	----------	--	---------------	--------------

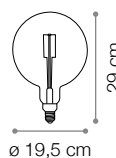

E27	4 W	320 Lm	2200 K	15.000 h	✓	223834	35,00
E27	4 W	320 Lm	2200 K	15.000 h		130187	30,00

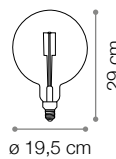

E27	4 W	200 Lm	2200 K	15.000 h		204536	32,00
-----	-----	--------	--------	----------	--	---------------	--------------

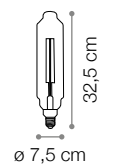

E27	4 W	320 Lm	2200 K	15.000 h		130170	33,00
-----	-----	--------	--------	----------	--	---------------	--------------

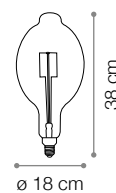

E27	4 W	320 Lm	2200 K	15.000 h		129860	34,00
-----	-----	--------	--------	----------	--	---------------	--------------

Lampadine GU10

108292

101378

189062



Lamp socket	Power	Flux	CCT	Life	Dimmable	Code	€
GU10	5 W	400 Lm	3000 K	25.000 h		108292	3,50
GU10	5 W	420 Lm	4000 K	25.000 h		253497	3,50 <i>new</i>
GU10	7 W	640 Lm	3000 K	25.000 h		123943	3,90
GU10	7 W	680 Lm	4000 K	25.000 h		224367	3,90
GU10	7 W	560 Lm	3000 K	25.000 h		101378	6,50
GU10	7 W	600 Lm	4000 K	25.000 h		117652	6,50
GU10	8 W	750 Lm	3000 K	25.000 h		189062	6,90

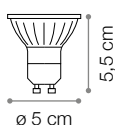

ø 5 cm

5,5 cm

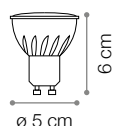

ø 5 cm

6 cm

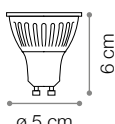

ø 5 cm

6 cm

242040

183794

189031



Lamp socket	Power	Flux	CCT	Life	Dimmable	Code	€
GU10	12 W	960 Lm	3000 K	15.000 h		242040	13,50 <i>new</i>
GU10	12 W	1050 Lm	3000 K	20.000 h		183794	14,50
GU10	12 W	1100 Lm	4000 K	20.000 h		253466	14,50 <i>new</i>
GU10	13 W	950 Lm	3000 K	15.000 h		189031	14,50
GU10	13 W	1000 Lm	4000 K	15.000 h		253398	14,50 <i>new</i>

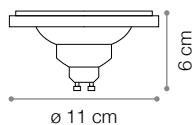

ø 11 cm

6 cm

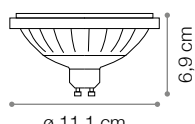

ø 11,1 cm

6,9 cm

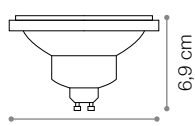

ø 11,1 cm

6,9 cm

Lampadine GX53

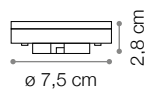

Lamp socket	Power	Flux	CCT	Life	Dimmable	Code	€
GX53	7 W	560 Lm	3000 K	25.000 h		101385	5,50
GX53	7 W	600 Lm	4000 K	25.000 h		253404	5,50 <small>new</small>
GX53	9,5 W	760 Lm	3000 K	25.000 h	✓	252551	7,90
GX53	9,5 W	760 Lm	3000 K	25.000 h		123936	5,90
GX53	9,5 W	800 Lm	4000 K	25.000 h	✓	252568	7,90
GX53	9,5 W	800 Lm	4000 K	25.000 h		154008	5,90

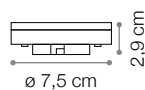

Lampadine R7s

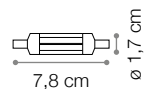

Lamp socket	Power	Flux	CCT	Life	Dimmable	Code	€
R7s	6 W	850 Lm	3000 K	30.000 h		189109	12,90
R7s	10 W	1200 Lm	3000 K	30.000 h		189093	17,00
R7s	10 W	1300 Lm	4000 K	30.000 h		253480	17,00 <small>new</small>

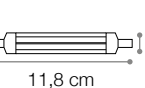

Strip LED and Driver

Volt	24 Vdc
MacAdam	SDCM 3
Beam	115°
LED life	50.000 h

SMD 3014 60 LED/m CRI ≥80

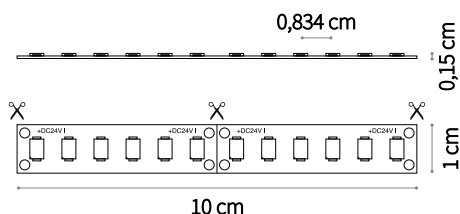

Power	IP	Flux	CCT	Length	Code	€
12 W/m	IP20	1100 Lm/m	2700 K	3000 mm	253787	95,00 <i>new</i>
		1200 Lm/m	3000 K	3000 mm	253794	95,00 <i>new</i>
		1270 Lm/m	4000 K	3000 mm	253817	95,00 <i>new</i>
	IP65	1130 Lm/m	3000 K	3000 mm	253800	100,00 <i>new</i>

SMD 2835 120 LED/m CRI ≥85

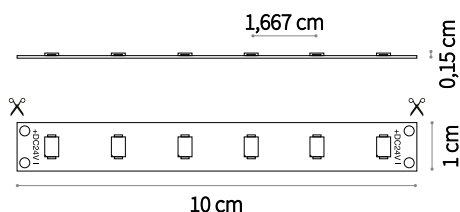

Power	IP	Flux	CCT	Length	Code	€
13 W/m	IP20	1100 Lm/m	2700 K	3000 mm	253824	30,00 <i>new</i>
				5000 mm	183336	46,00
		1200 Lm/m	3000 K	3000 mm	253831	30,00 <i>new</i>
				5000 mm	124032	46,00
		1270 Lm/m	4000 K	3000 mm	253855	30,00 <i>new</i>
				5000 mm	124049	46,00
	IP65	1130 Lm/m	3000 K	3000 mm	253848	44,00 <i>new</i>
				5000 mm	124056	64,00

SMD 2835 120 LED/m CRI ≥90

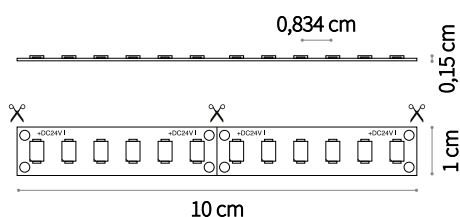

Power	IP	Flux	CCT	Length	Code	€
26 W/m	IP20	1500 Lm/m	3000 K	3000 mm	253862	59,00 <i>new</i>
				5000 mm	151847	83,00
		1600 Lm/m	4000 K	3000 mm	253879	59,00 <i>new</i>
				5000 mm	151854	83,00

SMD 2835 180 LED/m CRI ≥90

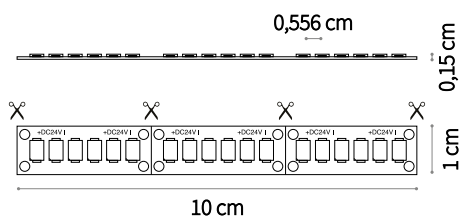

Power	IP	Flux	CCT	Length	Code	€
39 W/m	IP20	3700 Lm/m	3000 K	3000 mm	253886	119,00 <i>new</i>
		3900 Lm/m	4000 K	3000 mm	253893	119,00 <i>new</i>



DRIVER Solo per installazione in interni



	Power	Output	Class	Measure	Code	€
On-Off	30 W	24 Vdc	□	140x45x28 mm	124070	17,00
	60 W	24 Vdc	□	166x50x33 mm	124087	30,00
	100 W	24 Vdc	⊕	127x97x30mm	124100	37,00
	150 W	24 Vdc	⊕	159x97x30mm	124117	43,00
	200 W	24 Vdc	⊕	215x115x30mm	153001	60,00
1-10V/Push	36 W	24 Vdc	□	175x44x30 mm	244556	50,00 <i>new</i>
	75 W	24 Vdc	⊕	204x62x34 mm	244570	100,00 <i>new</i>
	150 W	24 Vdc	⊕	273x57x37 mm	244594	130,00 <i>new</i>
DALI/Push	36 W	24 Vdc	□	175x44x30 mm	244549	80,00 <i>new</i>
	75 W	24 Vdc	⊕	204x62x34 mm	244563	120,00 <i>new</i>
	150 W	24 Vdc	⊕	273x57x37 mm	244587	180,00 <i>new</i>





Kit Emergency

Kit luce d'emergenza per moduli LED. Include inverter e batteria. Autonomia da due a tre ore con un tempo di ricarica rispettivamente di 12 e 24 ore. Funzionamento in sola emergenza o in luce continua (luce continua in abbinamento con alimentatori elettronici e alimentatori elettronici dimmerabili). Protetto in classe II.

221595 ■ € 100,00

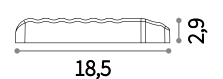
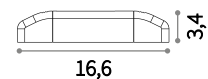

□ IP20

0,185 Kg / 0,0009 m³
Ⓢ 52 mm

0,305 Kg / 0,0010 m³
Ⓢ 65 mm

Per ulteriori informazioni, si prega di contattare l'ufficio tecnico.



Chef

Sistema lineare a moduli con driver incorporati. Connessioni a innesto rapido. Fissaggio con supporti magnetici o adesivi.

LED Sorgente luminosa LED 3000 K, 25.000 h di durata.

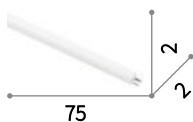

□ IP20

0,120 Kg / 0,0007 m³
LED 9W / 600 Lm

167664 € 60,00

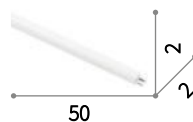

□ IP20

0,090 Kg / 0,0005 m³
LED 6W / 450 Lm

167442 € 40,00

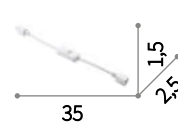

0,040 Kg / 0,0002 m³

203157 € 11,90

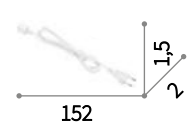

0,080 Kg / 0,0007 m³

173900 € 7,50



Rosoni

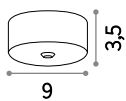

Magnetico



244235 € 12,90 *new*



244259 € 12,90 *new*



249315 € 13,90 *new*



249308 € 13,90 *new*



244242 € 12,90 *new*

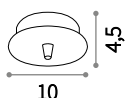

122823 € 5,90



122830 € 5,90



249278 € 6,90 *new*



249261 € 6,90 *new*



123295 € 5,90

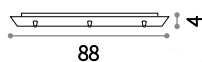

122854 € 29,00



122861 € 29,00



249292 € 32,00 *new*



249285 € 32,00 *new*



123301 € 29,00

Cavi e Supporti

∅5 x 1000 mm
2 x 0,75 mm²
FEP T180°
PVC T90°



128849 € 2,50



038940 € 2,50 *new*



249179 € 2,50 *new*



249162 € 2,50 *new*



128832 € 2,50



143200 € 4,90



143224 € 4,90



249339 € 4,90 *new*



249322 € 4,90 *new*



143217 € 4,90

Portalampada

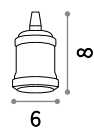

249186 € 10,90 *new*



249193 € 10,90 *new*



249223 € 10,90 *new*



249216 € 10,90 *new*



249209 € 10,90 *new*

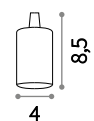

242569 € 5,90 *new*



249230 € 5,90 *new*



249254 € 5,90 *new*



249247 € 5,90 *new*



242576 € 5,90 *new*

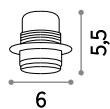

187013 € 6,90



155173 € 6,90



155180 € 6,90

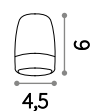

155104 € 10,90



155234 € 10,90



Indice per codice



ideal lux



Indice per codice

		005881	457	009537	229	015125	518	019765	159	025421	80
		005898	457	009681	129	015132	518	019772	274	025438	80
000206	268	005911	461	009698	129	015286	550	020228	764	025490	476
000251	286	006161	251	009704	403	015439	418	020365	426	026473	216
000268	286	006321	185	009933	230	015750	552	020556	429	026480	216
000275	286	006338	185	009940	230	015965	539	020594	413	026558	216
000305	251	006840	96	009957	230	016016	540	020600	413	026565	178
000619	519	007021	240	010069	283	016122	152	020716	370	026695	425
000657	150	007038	240	010861	179	016399	493	020723	370	026749	96
001180	542	007045	240	010892	817	016535	128	020747	370	026787	68
001197	549	007069	240	012209	523	016559	273	020822	451	026855	537
001814	81	007151	426	012605	298	016863	47	020839	451	026862	537
001821	81	007380	232	012865	451	016931	82	020846	514	026954	814
002040	98	007397	232	012872	451	017082	217	020853	531	026961	814
002408	394	007533	455	012889	531	017297	242	020877	555	026978	763
002705	259	007960	181	012902	514	017303	242	020891	178	026985	814
002767	259	007977	181	012919	66	017310	242	020969	403	026992	814
002774	259	007984	181	013046	502	017327	243	020976	403	027005	763
002781	187	007991	181	013060	502	017334	243	020983	506	027081	234
002880	555	008325	193	013244	66	017440	64	021416	455	027098	234
002897	517	008349	38	013275	245	017518	738	021430	455	027104	234
002903	517	008356	262	013657	527	017587	292	022222	144	027265	234
003108	98	008363	38	013763	194	017617	202	022239	144	027289	307
003283	531	008370	143	013787	514	018010	437	022277	192	027357	61
003399	420	008455	143	013800	481	018072	418	022499	94	027364	61
003528	550	008608	483	013817	481	018089	152	022505	94	027418	385
003535	523	008615	483	013923	40	018508	179	022772	409	027821	385
004099	403	008622	483	014166	231	018515	772	022789	411	027838	385
004211	169	008776	77	014371	298	018522	772	022987	555	027852	493
004235	213	008851	245	014395	394	018546	297	023021	65	027876	493
004419	515	008905	244	014432	244	018775	519	023038	65	027906	85
004426	479	008912	244	014449	244	018829	258	023328	43	028323	215
004556	421	009087	102	014456	244	018836	258	024097	805	028361	215
004716	763	009131	268	014593	264	018850	186	024134	760	028460	515
004723	814	009148	102	014609	304	019383	409	024486	454	028682	169
004730	814	009155	268	014616	274	019390	409	024493	480	028699	169
005041	375	009223	158	014623	517	019451	474	024509	480	030326	68
005126	298	009360	57	014630	517	019468	474	025032	420	030784	144
005218	86	009377	257	014814	203	019499	429	025261	493	031071	258
005225	235	009391	57	014920	540	019635	178	025278	372	031088	258
005294	233	009407	57	014968	556	019642	178	025285	372	031095	258
005379	240	009414	57	014975	539	019734	91	025292	493	031101	186
005386	240	009483	257	015101	518	019741	91	025308	372	031361	231
005454	233	009513	229	015118	518	019758	159	025315	372	031460	251

031477	251	034720	386	044187	45	051864	214	060231	99	068305	536
031484	235	034935	534	044194	45	051932	230	060491	504	068459	24
031491	235	034942	534	044200	45	051949	230	060507	392	068466	24
031507	243	035185	215	044248	396	051956	230	060514	392	071015	87
031651	148	035369	559	044255	396	051963	230	060620	214	071022	87
031668	148	035505	90	044279	174	051970	230	061115	309	073132	453
031712	421	035512	158	044286	174	051987	230	061122	309	073149	453
031743	46	035529	90	044293	174	052144	233	061139	309	073187	151
031750	46	035536	158	044392	504	052151	233	061160	281	073224	151
031996	90	035543	158	044422	397	052359	62	061191	281	073255	151
032009	90	035574	412	044453	397	052366	62	061450	770	073262	151
032016	90	035581	412	044491	543	052373	62	061467	770	073392	558
032023	158	035598	507	044590	287	052786	89	061474	770	073408	538
032030	158	035604	388	044606	287	052793	110	061580	785	073422	538
032047	158	035611	388	044767	429	052809	110	061597	785	073439	538
032078	265	035628	388	044774	429	052816	110	061788	793	073453	411
032122	102	035635	388	044910	504	052991	147	061818	793	073521	732
032139	102	035642	503	044927	392	053004	147	062211	429	073545	732
032313	557	035659	503	044934	392	053011	147	062273	301	073569	732
032351	123	035666	70	045030	527	053028	262	062396	698	073583	720
032368	275	035673	70	045047	527	053448	65	062402	698	073712	136
032375	275	035680	70	045115	101	053455	65	066387	44	073729	395
032382	305	035697	70	045122	101	057187	457	066394	44	073828	23
032436	528	035703	70	045139	267	057194	457	066400	153	073835	23
032467	528	035710	70	045191	199	057200	515	066424	153	074139	95
032504	385	035727	89	045207	199	059112	196	066431	414	074245	69
032597	419	035826	436	045214	199	059129	152	066448	414	074313	69
032610	419	035840	436	045627	237	059136	152	066592	89	074337	69
032825	836	035864	511	045634	237	059143	152	066608	89	074344	69
032832	836	035949	207	045672	405	059150	152	066622	459	074627	140
033013	777	035956	207	045726	180	059181	44	066639	459	074641	170
033020	777	035987	529	045733	180	059211	507	066868	785	074665	170
033037	829	036007	529	046167	765	059228	556	066882	793	074689	29
033044	829	036014	165	046181	765	059235	414	066899	793	074702	287
033532	432	036021	165	046211	829	059242	414	068121	202	074726	287
033662	97	036045	148	047799	97	059259	537	068138	163	074740	142
033679	97	036120	98	049229	231	059266	537	068145	163	074764	36
033686	266	038025	203	049236	231	059570	36	068169	88	074771	33
033938	194	038940	862	051406	543	059679	86	068176	88	074801	33
033945	263	041827	432	051444	738	059808	204	068183	407	074870	289
033952	65	042794	549	051741	301	059815	204	068190	407	074900	210
034546	227	043531	128	051765	301	059822	204	068268	511	074917	210
034706	386	043562	102	051840	214	059839	162	068275	554	074931	297
034713	386	044163	197	051857	214	060224	99	068299	434	074962	130

Indice per codice

		080390	176	083254	705	089614	61	092911	427	095998	730
		080857	195	086576	29	089638	63	092942	338	096018	730
075013	273	080932	146	086729	92	089669	63	093000	462	096100	122
075150	388	081434	175	086736	92	089775	817	093024	22	096162	122
075181	388	081441	175	086743	92	089782	276	093048	41	096476	766
075211	516	081496	502	086781	161	089805	317	093062	41	096483	766
075280	513	081502	378	086804	265	090252	400	093079	462	096544	838
075327	451	081519	378	087269	425	090269	400	093086	196	096551	838
075341	451	081526	378	087276	359	090337	220	093093	150	096568	838
075389	151	081533	502	087368	502	090481	95	093307	87	096575	838
075402	151	081540	378	087375	502	090764	77	093345	180	096582	838
075419	151	081557	378	087573	176	090863	164	093475	477	096599	838
075471	212	081564	378	087580	176	090900	164	093505	139	096667	792
075488	296	081762	97	087597	176	091006	175	093512	139	096674	792
075495	127	081960	192	087665	212	091013	175	093550	450	096681	792
075501	127	082059	26	087672	272	091112	101	093659	373	096698	792
075518	127	082073	26	087689	296	091129	231	093697	373	096704	793
075525	272	082158	428	087702	126	091136	231	093703	516	096711	793
075532	272	082172	428	087719	126	091143	63	093789	452	096728	793
077697	83	082196	428	087757	503	091518	764	093963	162	096735	793
077703	83	082240	790	087764	381	091525	764	093987	506	097183	246
077734	538	082257	428	087771	381	091983	298	093994	408	097190	246
077741	538	082264	509	087818	74	092157	773	094007	408	097206	246
077758	538	082271	790	087863	150	092164	773	094014	162	097664	457
077765	558	082288	509	087870	150	092188	786	094045	396	097671	457
077796	146	082387	271	087924	22	092195	786	094120	396	098043	139
077802	146	082448	295	087979	42	092201	786	094137	110	098586	160
077819	146	082493	206	088013	42	092218	772	094182	730	098616	93
077833	195	082509	122	088020	42	092225	822	094229	110	098722	39
077888	256	082783	146	088051	417	092300	777	094236	110	098739	39
077895	256	082790	146	088068	417	092317	777	094649	146	098777	143
077901	256	082813	195	088266	231	092324	757	094663	146	098784	193
077918	182	083070	704	088273	231	092355	785	094687	144	098944	201
077932	259	083087	704	088433	452	092393	788	094786	461	098951	201
077949	259	083117	704	088921	98	092409	788	094793	479	099057	257
077956	259	083124	704	088938	98	092416	788	095127	298	099064	258
077963	187	083131	704	088969	98	092423	788	095196	160	099101	119
079400	437	083148	704	089461	478	092430	788	095226	93	099118	163
080277	292	083179	704	089478	478	092447	788	095264	232	099170	39
080284	195	083186	704	089485	478	092751	458	095288	232	099217	193
080291	149	083193	704	089560	257	092782	458	095615	396	100272	456
080338	149	083223	704	089577	257	092836	491	095639	396	100289	456
080345	149	083230	704	089584	185	092850	338	095653	257	100302	456
080352	149	083247	704	089591	185	092881	338	095707	188	100326	369

100333	369	101514	805	106021	194	111957	28	114620	263	115962	512
100364	785	101552	761	106175	817	112084	99	114675	477	115979	438
100371	785	101576	141	106182	817	112107	99	114682	477	115986	438
100388	777	101590	141	106205	829	112268	28	114729	432	115993	438
100395	777	101606	31	107691	705	112299	140	114736	432	116006	438
100425	515	101613	31	107707	705	112305	362	114743	432	116099	218
100432	458	102047	373	108094	280	112312	362	114750	171	116112	179
100746	475	102054	373	108117	280	112336	362	114767	171	116228	427
100784	475	103112	85	108292	856	112343	362	114811	32	116235	427
100791	475	103136	85	108407	828	112367	64	115061	810	116457	55
100807	475	103174	364	109138	814	112381	64	115078	810	116464	55
100883	20	103204	207	109145	814	112398	416	115085	810	116570	286
100913	20	103242	126	110233	305	112459	64	115092	810	116587	286
100937	20	103266	164	110240	305	112626	492	115108	810	116594	286
100944	20	103273	164	110257	305	112671	57	115115	810	116716	802
100951	20	103327	434	110356	300	112695	492	115122	811	117652	856
101095	83	103419	377	110363	300	112701	356	115153	228	117737	424
101101	83	103426	377	110370	300	112718	57	115160	228	117782	410
101118	57	103440	482	110417	52	112732	356	115177	228	117867	221
101125	91	103501	380	110424	52	112800	433	115290	778	117881	836
101132	159	103518	380	110431	52	113197	433	115306	778	118659	763
101149	159	103693	566	110448	275	113302	59	115313	778	118666	770
101156	163	103709	566	110455	275	113319	59	115320	778	119410	311
101163	119	103723	34	110462	54	113333	56	115337	778	119427	198
101170	144	103792	477	110530	275	113654	504	115344	778	119458	311
101187	144	103983	47	110554	275	113678	397	115351	784	119465	198
101194	144	103990	82	110745	67	113692	293	115368	784	119502	198
101200	846	104355	735	110752	67	113715	205	115375	784	119571	848
101217	846	104485	181	110868	120	113753	780	115382	783	119786	257
101224	846	104539	175	110875	530	113760	780	115412	832	119830	185
101231	846	104546	175	110882	551	113791	781	115429	832	120201	830
101248	846	104775	396	110899	441	113975	448	115481	733	120218	830
101255	846	104928	568	111117	141	113982	705	115498	448	120249	839
101262	846	104935	568	111452	294	113999	705	115504	448	120287	840
101279	848	104942	568	111490	407	114019	705	115511	513	120317	839
101286	848	105239	143	111841	74	114170	378	115580	485	120324	839
101293	848	105277	38	111858	74	114187	378	115597	485	120362	840
101323	848	105284	262	111865	74	114194	378	115610	485	120386	839
101330	848	105628	126	111872	412	114200	502	115696	205	120423	761
101347	848	105659	548	111889	507	114262	34	115719	293	120430	761
101354	848	105710	744	111896	412	114279	432	115740	78	120454	805
101378	856	105727	745	111902	110	114293	780	115801	30	120898	362
101385	857	105734	745	111919	110	114347	823	115832	416	120904	362
101491	761	105741	744	111940	28	114361	32	115849	416	121130	240

Indice per codice

		123745	787	128849	862	133393	138	136707	472	138879	800
		123769	787	129082	52	133409	138	136714	472	138886	800
121147	240	123776	787	129099	52	133874	48	136738	340	138893	800
121154	240	123783	787	129242	550	133881	48	136882	731	138978	704
121161	240	123882	848	129433	776	133898	153	136899	731	138985	704
121178	240	123899	848	129440	776	133904	153	136905	731	138992	704
121338	240	123936	857	129457	776	133911	197	136929	570	139012	702
121352	251	123943	856	129464	759	134208	460	136936	570	139029	703
121376	276	123974	696	129471	759	134215	460	136943	570	139098	368
121406	317	123981	696	129488	759	134789	739	136998	711	139425	352
121413	276	123998	696	129495	759	134796	739	137001	711	139432	352
121437	317	124001	696	129501	759	134826	444	137032	37	139470	808
121963	770	124018	696	129518	759	134833	444	137056	37	139586	439
121970	833	124025	696	129525	782	134840	444	137124	346	139593	512
122014	843	124032	858	129532	782	134871	374	137261	73	139609	479
122021	843	124049	858	129570	532	134888	174	137285	264	139685	58
122045	783	124056	858	129600	449	134895	174	137292	73	139746	737
122052	375	124070	858	129709	446	134901	174	137308	73	139951	500
122083	352	124087	858	129860	848	134987	227	137315	73	140001	500
122106	352	124100	858	129877	848	135038	351	137391	775	140179	483
122168	855	124117	858	129921	446	135205	811	137407	775	140186	483
122205	164	124124	620	130163	848	135250	753	137599	240	140193	483
122212	164	124131	620	130170	848	135526	848	137605	240	140230	104
122236	126	124155	620	130187	848	135755	820	137612	240	140247	497
122243	126	124162	208	130903	445	135762	820	137681	368	140315	551
122557	364	124179	208	130910	445	135816	439	137698	510	140339	408
122564	364	124421	828	131733	526	135823	439	137704	510	140520	567
122601	434	125503	154	131788	466	135908	816	137827	318	140537	710
122663	757	125510	154	131795	466	135922	816	138008	577	140544	710
122687	757	125565	154	131924	104	135991	752	138237	576	140551	710
122717	257	125824	374	131955	799	136004	752	138251	740	140599	505
122731	185	125831	374	131962	739	136011	752	138275	34	140605	402
122748	185	125886	220	132228	78	136028	824	138282	303	140612	402
122823	862	125923	220	132365	84	136035	824	138305	109	140629	402
122830	862	126531	620	132389	84	136042	824	138343	440	140711	102
122854	862	126548	620	132778	315	136059	824	138374	200	140728	102
122861	862	126784	497	132785	315	136073	750	138510	820	140759	102
122878	541	126807	551	132976	209	136318	133	138527	314	140827	440
122885	541	126883	731	133041	23	136325	133	138596	712	140841	717
122984	258	126890	731	133058	23	136332	358	138602	712	140865	717
123066	221	126906	570	133263	224	136349	358	138619	712	140872	717
123080	770	126913	570	133270	224	136578	726	138633	712	140896	717
123295	862	128207	530	133300	224	136592	726	138640	712	140902	717
123301	862	128832	862	133386	138	136691	491	138657	712	140926	717

140933	717	143156	212	148175	344	151786	848	155869	719	159508	237
140957	717	143163	296	148502	344	151793	846	155906	340	159522	237
140988	55	143187	272	148847	750	151847	858	155968	35	159553	49
140995	55	143200	862	148854	750	151854	858	155982	735	159560	49
141046	503	143217	862	148861	750	151861	848	156026	35	159638	156
141053	381	143224	862	148878	750	151946	846	156033	35	159645	156
141060	381	143859	243	148908	200	151953	846	156316	332	159812	443
141084	404	144238	750	148939	553	151960	848	156323	332	159836	754
141268	737	144245	750	149561	109	151977	848	156330	332	159843	348
141275	737	144252	750	149585	110	151991	848	156347	332	159850	348
141794	568	144276	770	149592	110	152004	848	156392	499	159867	348
141800	568	144283	770	149608	138	152776	464	156408	499	159935	505
141817	568	144320	52	149615	138	152851	207	156415	484	159942	398
141855	568	144849	546	149622	138	152875	165	156682	572	159959	398
141893	131	144863	522	149684	491	152899	165	156699	572	159966	505
141909	131	144917	496	149738	779	152912	165	156705	732	159973	398
141916	131	145020	802	149745	779	153001	858	156712	720	159980	398
141923	440	145068	802	150116	703	153124	565	156729	733	159997	501
141954	440	145198	524	150130	702	153162	806	156736	733	160016	501
142050	258	145204	524	150284	701	153179	806	156743	733	160085	464
142067	186	145211	524	150291	703	153193	806	156774	721	160214	490
142081	258	145228	750	150307	702	153209	806	156781	721	160245	490
142098	186	145303	767	150420	718	153438	357	157030	565	160269	336
142197	218	145310	831	150437	718	153445	357	157146	166	160313	470
142203	218	145327	767	150468	718	153926	846	157160	166	160559	776
142227	380	145334	831	150475	718	153933	846	157580	848	160856	106
142241	249	145341	767	150581	743	153940	846	157597	848	160863	106
142258	249	145358	831	150628	575	153957	848	157856	825	161327	102
142265	727	145365	303	150635	575	153964	848	158242	206	161334	102
142272	727	146317	316	150666	575	153971	848	158655	568	161365	102
142289	727	146775	750	150673	575	153988	848	158686	568	161372	102
142296	727	146782	750	151649	846	154008	857	158709	460	161389	102
142302	779	146799	750	151656	846	155104	863	158723	568	161433	268
142333	226	147635	282	151663	846	155142	484	158785	460	161648	124
142340	226	147642	282	151687	848	155173	863	158808	460	161662	124
142517	491	147659	282	151694	848	155180	863	158815	18	161686	271
142579	249	147666	696	151700	848	155227	484	158822	785	161716	294
142586	249	147673	696	151717	848	155234	863	158860	18	161754	799
142616	559	147680	696	151724	848	155395	728	158891	818	161761	799
142692	248	147765	774	151731	846	155418	728	158907	753	161778	799
142708	248	147772	774	151748	846	155494	484	159010	167	161785	736
142906	572	147796	774	151755	848	155500	188	159256	443	161792	736
142913	572	147819	774	151762	848	155722	701	159263	466	161846	758
142999	820	148151	344	151779	848	155791	719	159423	237	161853	758

Indice per codice

Sk	Pag	165011	434	168159	351	172347	764	175706	177	182179	434
		165370	768	168234	125	172408	764	175720	225	183077	378
161907	807	165387	768	168258	401	172422	819	175768	182	183336	858
161921	807	166209	344	168289	401	172439	819	175799	182	183794	856
162089	739	166247	424	168319	72	172507	768	175935	58	186795	18
162102	739	166254	508	168326	72	172514	768	175973	100	186801	18
162201	326	166261	473	168357	72	172538	768	176000	100	186825	115
162416	350	166285	473	168364	72	172552	768	176031	100	186832	49
162478	326	166322	423	168579	365	172804	154	176062	100	186849	204
162492	818	166360	423	168586	365	172828	154	176291	383	186856	204
162737	447	166483	450	168609	365	172996	76	176352	341	186863	268
162751	447	166544	395	168753	384	173009	76	176369	341	186900	213
163109	353	166551	395	168777	384	173016	76	176536	253	186955	818
163123	353	166650	525	168821	421	173023	76	176550	253	186979	818
163154	353	166667	525	168852	463	173245	576	176628	255	186986	700
163161	353	166742	525	168869	463	173252	740	176666	204	186993	700
163321	492	166766	525	168906	397	173900	861	176680	269	187006	489
163338	492	166889	387	168913	509	173917	453	176734	107	187013	863
163369	312	166988	60	168920	474	174204	371	177199	306	187327	825
163536	785	167015	60	168937	474	174211	371	177205	306	187341	779
163543	785	167022	60	168951	465	174228	371	177212	306	187358	779
163550	785	167107	60	168968	465	174235	371	178776	223	187365	231
163598	786	167121	255	169118	232	174242	366	178783	223	187457	383
163604	777	167152	255	169576	654	174396	121	178790	223	187525	804
163611	777	167244	390	169583	654	174402	121	179292	741	187532	804
163628	777	167251	390	169590	654	174419	170	179308	741	187549	804
163635	777	167268	390	169606	654	174426	308	179315	741	187556	804
163642	757	167282	344	169613	654	174792	254	179322	741	187570	237
163666	757	167367	344	169620	654	174808	254	179612	115	187662	572
163727	829	167398	390	169637	654	174822	254	179643	494	187686	568
163741	814	167404	390	169644	654	174846	254	179667	494	187716	340
163758	814	167411	390	169705	654	174921	168	179681	237	187877	821
163772	362	167442	861	169712	654	174945	419	179766	74	187884	821
163789	362	167497	344	169729	654	174952	168	179858	132	187891	821
164601	212	167503	344	169736	654	174976	168	179902	554	187976	654
164823	730	167626	72	169958	654	174990	168	180045	779	187983	654
164847	730	167640	72	169972	654	175010	168	180212	495	187990	654
164878	572	167664	861	169989	654	175041	168	180229	495	188003	654
164953	392	168036	756	170145	654	175317	491	180298	498	188010	654
164960	392	168050	756	170152	654	175324	472	180304	498	188027	654
164977	428	168067	453	170589	568	175331	472	180922	449	188058	654
164984	428	168081	453	170596	570	175355	340	180946	553	188065	654
164991	475	168111	756	170602	731	175676	177	180953	801	188072	654
165004	475	168135	756	170923	231	175690	177	180960	801	188089	654

188096	654	189758	636	191362	606	192468	606	193533	688	196961	15
188102	654	189765	636	191379	606	192475	606	193540	688	196978	15
188119	654	189772	636	191416	606	192482	606	194110	688	196985	15
188126	654	189789	636	191423	606	192499	606	194127	688	196992	15
188195	654	189796	636	191430	606	192505	606	194134	688	197036	319
188911	846	189802	636	191447	606	192512	606	194141	688	197050	24
188928	846	189819	636	191454	606	192529	606	194172	572	197302	324
188935	846	189826	636	191461	606	192536	606	194189	572	197319	324
188942	848	189833	636	191478	606	192543	606	194196	572	197326	324
188959	848	189840	636	191485	606	192550	606	194202	572	197333	324
188966	848	189857	636	191492	606	192567	606	194257	654	197500	456
188973	848	189864	636	191508	606	192574	606	194295	344	197524	456
188980	855	189871	636	191577	798	192581	606	194301	654	197654	46
189000	855	189888	636	191584	798	192598	606	194417	288	197661	46
189031	856	189895	636	191591	606	192604	606	194448	288	197708	507
189062	856	189901	636	191607	798	192611	606	194677	367	197715	414
189093	857	189918	636	191614	797	192628	606	194684	367	197722	414
189109	857	189925	636	191621	797	192635	606	194806	568	197739	414
189147	848	189932	636	191638	797	192642	606	195285	24	197746	414
189154	848	189949	636	191645	606	192659	606	195483	796	197753	537
189161	848	189956	636	191652	606	192666	606	195490	796	197791	405
189178	848	189963	636	191669	606	192673	606	195506	796	197920	333
189505	636	189970	636	191973	606	192680	606	195704	729	198071	334
189529	636	189987	636	191980	606	192697	606	195711	729	198095	79
189536	636	189994	636	191997	606	192703	606	195728	729	198125	337
189543	636	190006	636	192277	682	192710	606	195735	729	198132	471
189574	636	190013	636	192284	682	192727	606	195742	729	198149	471
189581	636	190020	636	192291	682	192734	606	195759	729	198156	471
189598	636	190037	636	192307	682	192741	606	195766	729	198620	812
189604	636	190044	636	192314	682	192758	606	195773	729	198637	812
189611	636	190051	636	192321	682	193359	688	195872	350	198644	812
189628	636	190068	636	192338	682	193366	688	196190	222	198668	606
189635	636	190075	636	192345	682	193373	688	196206	222	198675	606
189642	636	190082	636	192352	682	193380	688	196220	222	198682	606
189659	636	190099	636	192369	682	193403	688	196640	171	198699	606
189666	636	190105	636	192376	682	193410	688	196657	171	198705	606
189673	636	190181	636	192383	682	193427	688	196688	256	198712	606
189680	636	190259	636	192390	682	193434	688	196695	256	199023	606
189697	636	190778	14	192406	682	193458	688	196701	183	199030	606
189703	636	191164	606	192413	682	193465	688	196718	183	199375	399
189710	636	191171	606	192420	606	193472	688	196770	50	199382	399
189727	636	191188	606	192437	606	193489	688	196787	50	199405	399
189734	636	191263	606	192444	606	193519	688	196794	50	199412	399
189741	636	191355	606	192451	606	193526	688	196800	50	199528	549

Indice per codice

		201078	270	205304	343	207858	347	211701	574	214498	160
		201085	293	205311	343	207889	54	211718	574	214504	160
199870	239	201092	205	205380	711	207988	334	211749	574	214511	160
199894	239	201115	270	205410	711	207995	334	211756	574	214672	742
199917	239	201122	293	205939	801	208046	78	211763	674	214689	742
199931	239	201252	848	205946	801	208053	78	211770	674	214696	742
199986	508	201269	848	205977	716	208152	436	211787	674	215440	616
199993	422	201276	848	205984	716	208282	467	211794	674	215693	207
200002	422	201283	848	205991	716	208299	467	211800	674	215709	207
200026	473	201290	848	206004	716	208398	328	211817	674	215747	177
200033	536	201368	335	206011	716	208497	436	211824	674	215761	177
200057	508	201382	533	206028	716	208541	674	211831	674	215778	177
200064	422	201399	533	206035	716	208558	674	211848	674	215785	177
200071	422	202396	682	206042	716	208565	674	211855	674	215891	606
200095	473	202921	791	206196	666	208572	674	211862	674	215907	606
200101	536	202945	791	206202	666	208589	674	211879	674	215969	431
200118	325	203072	620	206219	666	208596	674	211886	674	216027	674
200125	325	203089	620	206226	666	208602	674	211893	674	216263	674
200132	488	203102	620	206233	666	208626	674	212623	842	216270	606
200149	488	203119	620	206240	666	208640	674	212647	842	216287	606
200194	706	203126	620	206387	16	208657	674	213071	820	216294	606
200200	706	203133	708	206394	16	208664	674	213088	820	216300	606
200217	706	203140	708	206622	406	208671	674	213095	764	216317	674
200231	706	203157	861	206639	406	208688	674	213101	808	216324	674
200248	706	203171	246	206790	354	208695	674	213194	753	216416	606
200255	706	203188	246	206806	355	208701	674	213200	753	216423	606
200330	488	203195	246	206820	355	208718	674	213217	788	216430	606
200347	488	204451	848	206844	355	208725	674	213262	810	216447	606
200354	485	204468	848	206875	355	208732	674	213279	810	216829	654
200361	485	204475	848	207155	510	208749	674	213323	780	217253	682
200477	192	204505	848	207162	476	208794	490	213330	784	218724	754
200484	136	204536	848	207186	476	208817	335	213347	778	218823	688
200491	26	204543	848	207193	431	209036	855	213354	778	218830	688
200583	79	204581	620	207216	431	209043	855	213361	824	218847	688
200590	79	204598	620	207483	382	209845	762	213484	398	218854	688
200606	79	204611	620	207568	277	209852	762	213491	509	219721	118
200880	344	204628	620	207582	302	209906	809	213507	474	219738	118
200897	344	204635	620	207599	302	211381	562	213521	424	219875	121
200903	344	204888	278	207636	442	211398	562	213545	508	220604	342
200965	431	204895	278	207650	442	211404	562	213569	473	220611	342
200996	476	204949	310	207766	284	211459	574	213583	423	220628	481
201016	476	204956	310	207780	284	211466	574	214009	796	220635	481
201023	510	205281	343	207834	347	211541	430	214474	93	220659	454
201054	205	205298	343	207841	347	211558	430	214481	93	220772	688

220789	688	222769	580	223209	709	224367	856	227689	654	230702	172
220796	688	222776	616	223216	709	224466	308	227825	173	230726	172
220802	688	222783	616	223223	709	224473	270	227832	173	231105	214
220826	606	222790	616	223230	709	224480	236	229010	734	231129	214
220963	319	222813	616	223254	564	224497	114	229027	734	231143	214
221373	398	222820	842	223285	580	224541	330	229034	734	231211	576
221489	367	222837	842	223292	580	224633	285	229041	734	231228	55
221496	367	222844	837	223704	620	224640	285	229058	722	231235	576
221502	762	222851	837	223711	620	224718	594	229065	722	231259	55
221519	762	222868	837	223728	620	224725	594	229072	722	231273	55
221595	860	222875	837	223735	620	224732	594	229089	722	231297	55
221649	674	222882	580	223742	620	224756	594	229430	577	231341	116
221656	674	222899	580	223759	620	224763	594	229461	563	231372	116
221663	674	222905	580	223766	620	224930	238	229478	563	231396	116
221670	674	222912	580	223773	616	224954	238	229485	563	231433	116
221687	674	222929	580	223780	616	224985	238	229492	563	231471	189
221694	674	222936	580	223797	616	224992	238	229508	563	231495	189
222097	562	222943	580	223803	616	225005	238	229515	563	231556	19
222103	562	222950	580	223834	848	225029	238	229522	784	231563	19
222110	562	222967	580	223919	848	225104	547	229539	784	231570	19
222257	855	222974	580	223926	848	225111	489	229546	784	231587	19
222509	628	222981	580	223933	848	225128	470	229553	707	231594	19
222523	628	222998	580	223940	848	225135	331	229560	707	231600	19
222530	628	223001	580	223964	848	225364	628	229577	707	231631	650
222547	628	223018	580	223988	594	226026	105	229584	707	231662	650
222554	628	223025	580	223995	594	226033	105	229591	707	231686	650
222561	628	223032	580	224022	594	226040	105	229607	707	231723	650
222578	628	223049	580	224053	594	226057	269	229614	707	231754	651
222585	628	223056	580	224060	594	226187	837	229621	707	231815	652
222592	628	223063	580	224084	594	226187	842	229638	706	231839	653
222608	628	223070	580	224091	594	226194	837	229645	706	232041	368
222615	628	223087	580	224107	594	226194	842	229652	646	232331	313
222622	628	223094	580	224114	594	226200	837	229669	646	232362	313
222639	628	223124	580	224121	594	226200	842	229676	646	232409	313
222646	628	223131	580	224138	594	226217	837	229683	646	232485	266
222653	628	223148	580	224145	594	226217	842	229706	648	232508	266
222660	628	223155	580	224169	594	226712	564	229720	648	232546	266
222677	628	223155	594	224176	594	226729	564	229737	648	232690	51
222684	628	223162	580	224183	594	226736	564	229751	648	232713	51
222691	628	223162	594	224190	594	226743	564	229768	648	232720	51
222707	628	223179	580	224213	594	226750	564	229782	648	232744	51
222714	628	223179	594	224237	594	227580	654	229874	719	232966	184
222745	580	223186	709	224275	580	227597	654	229997	703	232980	184
222752	580	223193	709	224275	594	227672	654	230580	702	233017	184

Indice per codice

		237299	848	239682	211	243283	654	245041	826	246895	654
		237305	848	239699	211	243450	717	245072	826	246901	654
233031	184	237336	848	239705	747	243481	813	245089	826	246918	811
233062	714	237343	848	239811	747	243498	476	245096	826	246925	764
233079	714	237350	848	240367	712	243528	431	245102	826	246932	819
233116	714	237367	848	240374	712	243566	476	245331	276	246949	764
233192	714	237374	848	240473	712	243597	431	245348	276	246956	819
233215	714	237381	848	240510	712	243641	580	245393	276	246963	810
233222	714	237398	361	241012	26	243658	580	245669	562	246970	810
233321	714	237428	361	241036	26	243665	606	245676	562	246987	825
233352	714	237442	361	241050	136	243818	704	245683	562	246994	825
233376	714	237497	361	241173	108	243825	704	245690	562	247007	654
233659	249	237510	361	241197	108	243849	704	245706	562	247014	765
233666	618	237664	339	241203	108	243900	580	245713	562	247021	765
233673	249	237671	339	241227	108	243917	580	246390	664	247038	829
233680	249	237794	376	241241	108	243924	717	246413	628	247045	832
233703	249	237800	376	241258	108	243931	717	246437	628	247069	768
233765	715	237930	252	241296	477	243948	717	246444	628	247076	768
233772	715	238104	360	241340	329	243986	662	246451	654	247083	779
233826	715	238128	535	241357	329	243993	662	246468	654	247106	807
233833	715	238135	360	241364	329	244013	662	246499	654	247113	807
233840	618	238173	360	241517	82	244181	664	246505	654	247120	807
233857	249	238210	360	241524	82	244198	664	246512	654	247137	807
233864	249	238241	327	241968	618	244204	664	246529	654	247144	843
233970	715	238333	471	241975	618	244235	862	246536	654	247151	843
234007	715	238388	277	241982	618	244242	862	246543	654	247168	767
235134	113	238746	349	241999	618	244259	862	246550	654	247175	831
235141	113	238838	349	242002	618	244549	858	246567	654	247182	766
235455	25	238920	349	242019	618	244556	858	246574	654	247199	830
235486	25	238944	219	242040	856	244563	858	246581	654	247618	654
235516	25	238951	219	242347	336	244570	858	246598	654	247625	654
235547	25	238975	219	242378	470	244587	858	246604	654	247779	157
235929	117	239132	112	242385	490	244594	858	246611	654	247823	698
235936	117	239163	112	242392	490	244600	704	246628	654	247830	698
236841	777	239217	647	242569	863	244624	116	246796	754	247847	664
236858	777	239224	647	242576	863	244648	116	246802	754	247854	664
236865	757	239521	211	242705	654	244662	189	246819	760	247861	628
236957	17	239545	211	243160	252	244808	747	246826	760	247878	628
236964	17	239576	211	243184	738	244822	747	246833	805	247885	628
237022	723	239590	211	243191	738	244846	747	246840	805	247939	628
237039	723	239606	211	243238	654	244853	747	246857	762	247946	628
237046	723	239613	211	243245	654	244860	666	246864	762	247953	628
237251	848	239637	211	243252	654	244884	666	246871	809	247960	628
237268	848	239644	211	243269	654	244891	666	246888	816	247977	628

247984	628	248820	594	249452	802	252599	179	256078	654
247991	628	248837	594	249469	802	252605	179	256085	654
248165	662	248844	594	249476	802	252612	179	256092	654
248172	662	248868	594	249483	802	252629	179	256115	654
248189	662	248875	594	249490	802	252636	179	256122	654
248196	662	248882	594	249506	802	252643	179	256146	654
248202	813	248899	594	249513	802	252971	674		
248219	813	248905	594	249520	802	252988	674		
248226	813	248912	594	249629	654	252995	674		
248233	813	248929	594	249643	628	253008	674		
248240	813	248936	594	249650	628	253015	674		
248257	814	248950	694	249674	628	253022	674		
248264	814	248967	694	249681	628	253381	855		
248271	814	248974	694	249698	628	253398	856		
248288	814	248981	694	249704	628	253404	857		
248295	814	248998	694	249711	664	253411	846		
248370	662	249001	694	249728	664	253428	848		
248387	826	249018	694	249810	746	253435	848		
248394	826	249025	694	249827	746	253442	848		
248400	522	249032	694	249834	746	253459	848		
248417	269	249049	694	250106	250	253466	856		
248479	288	249056	360	250113	250	253473	855		
248486	288	249063	360	250120	250	253480	857		
248493	651	249070	360	250137	250	253497	856		
248509	651	249087	360	250274	277	253558	628		
248516	666	249162	862	250281	277	253787	858		
248523	666	249179	862	250304	110	253794	858		
248530	666	249186	863	250311	110	253800	858		
248554	361	249193	863	250328	110	253817	858		
248561	652	249209	863	250335	110	253824	858		
248592	662	249216	863	250342	110	253831	858		
248608	662	249223	863	250359	110	253848	858		
248615	826	249230	863	250366	109	253855	858		
248691	594	249247	863	250373	109	253862	858		
248714	594	249254	863	250403	644	253879	858		
248738	594	249261	862	250410	644	253886	858		
248745	594	249278	862	250427	644	253893	858		
248752	594	249285	862	250434	644	254944	580		
248769	594	249292	862	250441	644	254951	594		
248776	594	249308	862	250458	644	254968	594		
248783	694	249315	862	252186	848	255996	654		
248790	694	249322	862	252209	848	256030	654		
248806	594	249339	862	252551	857	256047	654		
248813	594	249346	784	252568	857	256061	654		

Icone tecniche

Classi di isolamento

 Classe I Sicurezza elettrica garantita dall'isolamento principale e da un conduttore di protezione (messa a terra) collegato alla struttura metallica della lampada. Messa a terra obbligatoria.

 Classe II Sicurezza elettrica garantita dall'isolamento principale e da un doppio isolamento o da un isolamento rinforzato. Non deve avere messa a terra.

 Classe III Sicurezza elettrica garantita dall'alimentazione a bassissima tensione (inferiore a 50 Volt). Non deve avere messa a terra.

 Apparecchio non idoneo al montaggio diretto o incasso su superfici normalmente infiammabili.

 Marchio di conformità alle direttive comunitarie europee di sicurezza.

Simboli

 Lampadina inclusa.

 Articoli con lampade a LED: consumo estremamente ridotto, luce chiara e concentrata, robustezza e lunga durata.

 Interruttore integrato nel corpo luce.

 Apparecchio dotato di interruttore touch: si accende e si regola l'intensità col tocco di un dito sul corpo luce.

 Apparecchio fornito con variatore di potenza.

 Grado di protezione IP44.

 Grado di protezione IP54.

 Grado di protezione IP68.

 Lampada con presa USB integrata.

 Articolo adatto alla pittura e verniciatura.

 Articolo in acciaio inox 316.

Contatti

IDEAL LUX s.r.l.
Via Taglio Destro, 32
30035 Mirano (Venezia)
P.I. / C.F. 02420040277

IDEAL LUX Warehouse
Via delle Industrie, 8/D
30036 Santa Maria di Sala (Venezia)
8.00 - 12.00 / 13.30 - 17.00

IDEAL LUX Web
www.ideal-lux.com
info@ideal-lux.com

IDEAL LUX Office
Tel. +39 041 5790500
Fax +39 041 8872349
8.00 - 12.00 / 13.30 - 17.30

Note

Ideal Lux s.r.l. si riserva il diritto di apportare, in qualunque momento e senza preavviso, tutte le modifiche necessarie a migliorare la qualità degli articoli illustrati nel presente catalogo.

I nostri prodotti in classe I e II si alimentano con tensione nominale di 220-240 Vac 50/60 Hz. Tutti i nostri prodotti sono conformi alle direttive CE.

Qualora acquistato separatamente come "optional", il DRIVER DIMMERABILE sarà già incluso nel prodotto in sostituzione del driver standard on-off: verrà fornito un solo driver.

I valori riferiti ai Lumen relativi alle lampade con sorgenti integrate a LED, sono da considerarsi NOMINALI, riferiti cioè alla sorgente. Per i Lumen effettivi dei singoli apparecchi illuminanti si prega gentilmente di consultare le fotometrie. Per ulteriori delucidazioni e aggiornamenti si prega di contattare l'ufficio tecnico.

Community Design Pending Nr. 001996372 002022038 002194993 002621862 002943449 003734342 004558609 006083655

Copyright 2020 © IDEAL LUX S.r.l. – All rights reserved – Tutti i diritti sono riservati

