

NV/NH

## Siguranță fuzibilă NV/NH gTr

**Date tehnice:**

Tensiune nominală	400 V a.c.
Puterea transformatorului	50-100 kVA
Capacitate de rupere	100 kA

Caracteristici  
timp curent  
I/t, gTr

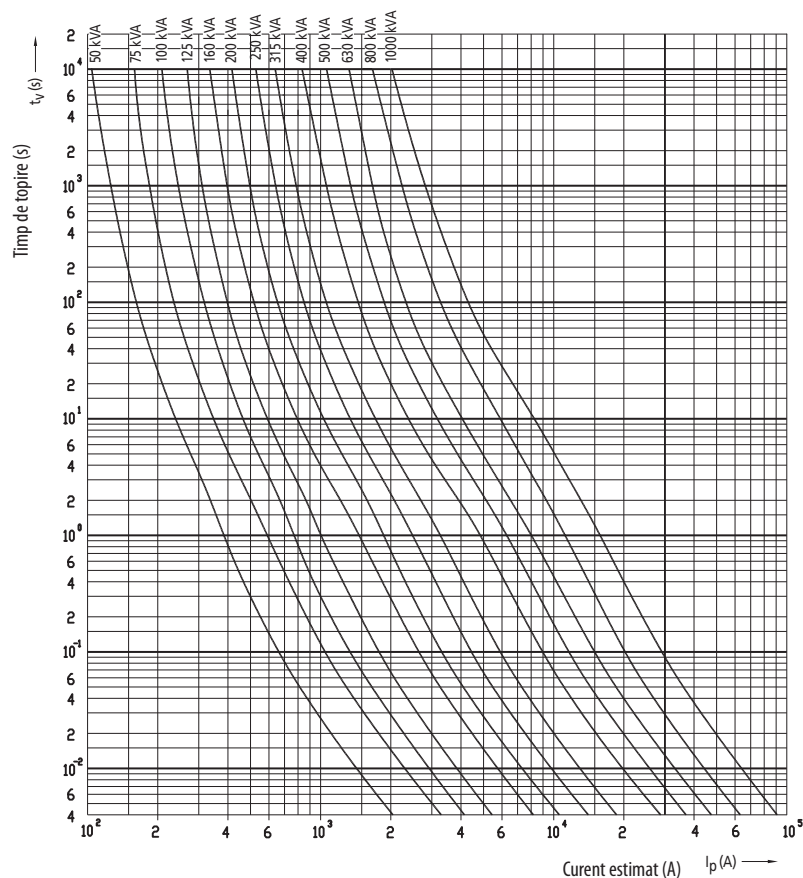

## Soclu pentru siguranțe

**Date tehnice:**

Tensiune nominală $U_n$	690 V a.c.
Curent nominal $I_n$	160 A - marimea 00C, 00, 0 250 A - marimea 1 400 A - marimea 2 630 A - marimea 3
Grad de poluare	3 to IEC 60947, DIN EN 60947, DIN VDE 0110
Standarde	IEC 60269, DIN EN 60269, DIN VDE 0636, HRN EN 60269

**Soclu pentru siguranțe PLNV**

Type	A	B	C	D	E	F	G	H	I	J
2PLNV - 1/1	140	175	200	25	-	-	76	82	-	M10
2PLNV - 2/1	154	200	230	30	-	-	83	87	-	M10
2PLNV - 3/1	154	210	250	30	-	-	91	95	-	M12
2PLNV - 1/3	140	175	200	25	65	187	76	82	103	M10
2PLNV - 2/3	154	200	230	30	65	187	83	87	112	M10
2PLNV - 3/3	154	210	250	30	80	217	91	95	126	M12

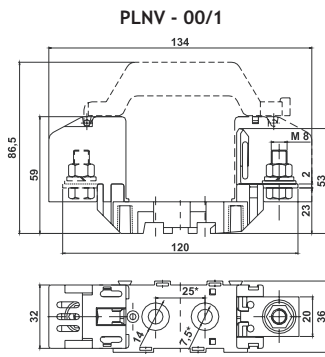

2PLNV - 1/1, 2PLNV - 2/1, 2PLNV - 3/1

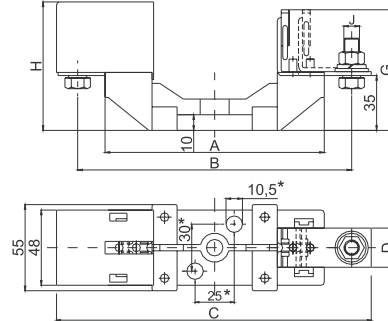

PLNS - 00N

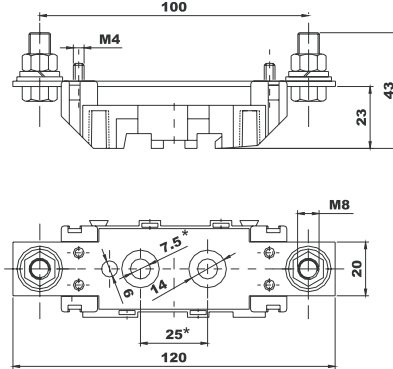

\*baze pentru siguranțe PLN - 00/3 fixează cu patru șuruburi minim (distanța dintre găuri 25x68 mm)

2PLNS - 1N, 2PLNS - 2N

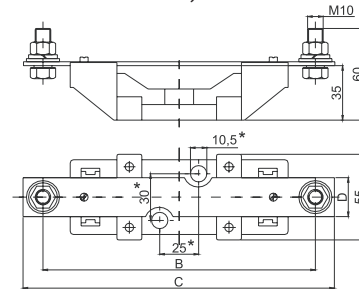

	2PLNS - 1N	2PLNS - 2N
B	175,6	200
C	200	230
D	25	30

Soclu siguranță monopoar PK și PKI

tip	dimensiuni												
	A	B	C	D	E	F	G	H	I	J	K	L	M
PK 00 M8 - 2 x M6	100	57	84	60	M8 - 2 x M6	Ø7,5			25	4,5	115		20
PK 00 M8 - M8	100	57	84	60	M8 - M8	Ø7,5			25	4,5	115		20
PK 00 2 x M6 - 2 x M6	100	57	84	60	2 x M6 - 2 x M6	Ø7,5			25	4,5	115		20
PK 0 M8 - 2 x M6	150	74	130	60	M8 - 2 x M6	Ø7,5		33	25	4,5	170		20
PK 0 M8 - M8	150	74	130	60	M8 - M8	Ø7,5		33	25	4,5	170		20
PK 02 x M6 - 2 x M6	150	74	130	60	M8 - 2 x M6	Ø7,5		33	25	4,5	170		20
PK 1	175	80	141	81	M10	Ø10,5	30	55	25	10	200		26
PK 2	200	80	166	102	M10	Ø10,5	30	65	25	10	225		30
PK 3	210	80	166	102	M12	Ø10,5	30	65	25	10	240		30
PK 4	270	100	220	143	M12	Ø13	30	102	25	12	310		50
PKI 1	175	80	141	81	M10	Ø10,5	30	55	25	10	200	87	26
PKI 2	200	80	166	102	M10	Ø10,5	30	65	25	10	225	98	30
PKI 3	210	80	166	102	M12	Ø10,5	30	65	25	10	240	108	30
PK 1/1000V	193	100	160	81	M10	Ø10,5	30	55	25	10	220		26

Socurile PKI și PPI sunt prevăzute cu capace izolatoare pentru o protecție suplimentară împotriva unei atingeri accidentale

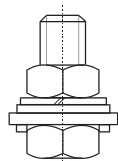

conexiune M8  
(6 - 50 mm<sup>2</sup>Cu)

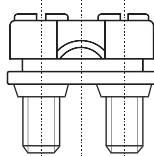

conexiune 2 x M6  
(6 - 70 mm<sup>2</sup>Cu)

