

DIAMETRO DI FORATURA PANNELLO  
PANEL DRILLING HOLE

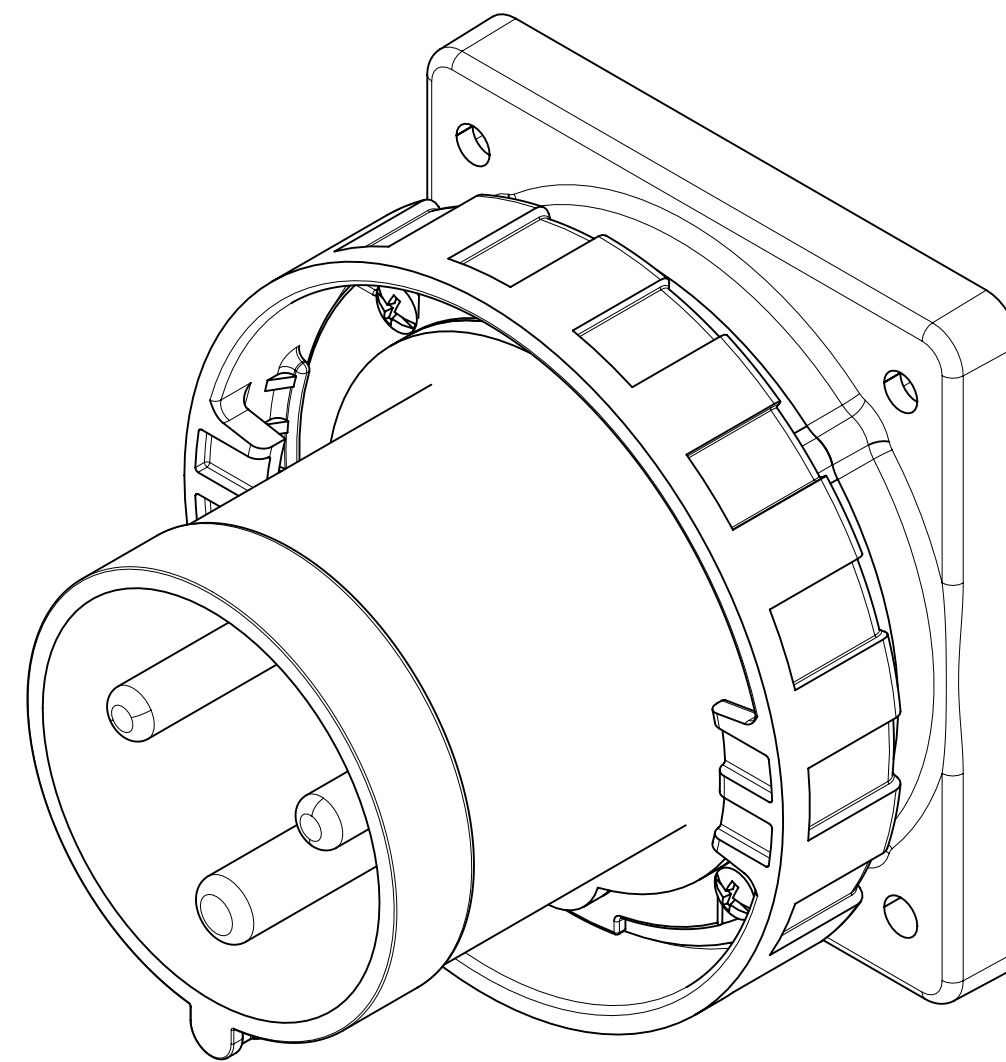

IL DISEGNO SI RIFERISCE ALLA POSIZIONE 6H  
DWG REFERS TO CLOCK POSITION 6H

At the end of the law, we reserve the ownership of this design may not be copied and transfer it to third parties or competitors	Format	A2	Scale	1:1	Mould N°	1000XXXX	Drawn	SCAME	
	Tolerances for linear and angular dimensions without indication of specific tolerances: JS13 / UNI EN20286							Date	
 S.p.A. PARRE - (Bergamo)	DESCRIPTION							CODICE	Sheet 1 / 1
	SPINA INCASSO 2P+T 63A OPTIMA IP67								4000667