

DIAMETRO DI FORATURA PANNELLO
 PANEL DRILLING HOLE

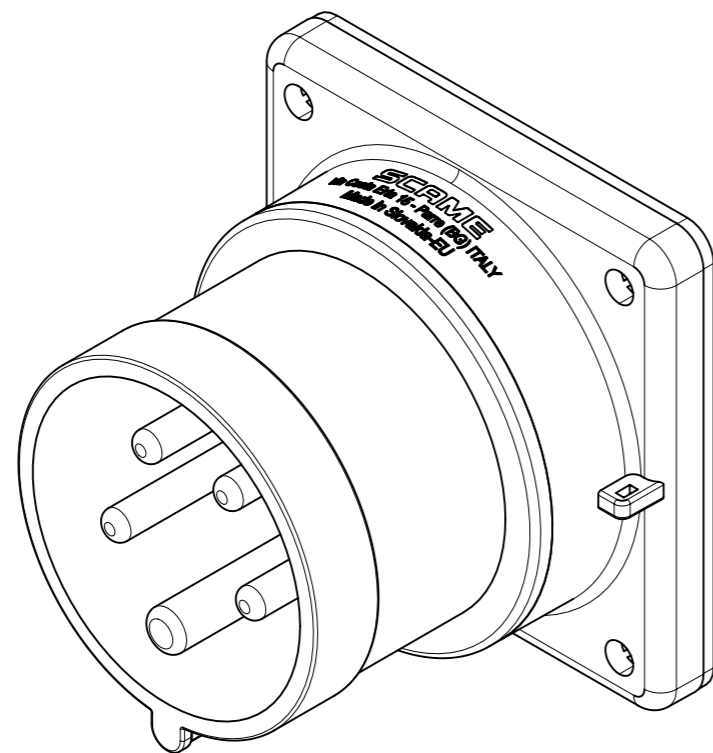

IL DISEGNO SI RIFERISCE ALLA POSIZIONE 6H
 DWG REFERS TO CLOCK POSITION 6H

At the end of the law, we reserve the ownership of this design may not be copied and transfer it to third parties or competitors	Format	A3	Scale	1:1	Mould N°		Drawn	SCAME
	Tolerances for linear and angular dimensions without indication of specific tolerances: JS13 / UNI EN20286							Date
 S.p.A. PARRE - (Bergamo)	DESCRIPTION						CODICE	Sheet 1 / 1
	SP. FIS. 3P+N+T 16A 6H IP44 OPTIMA REV.						4000504	