

DIAMETRO DI FORATURA PANNELLO
PANEL DRILLING HOLE

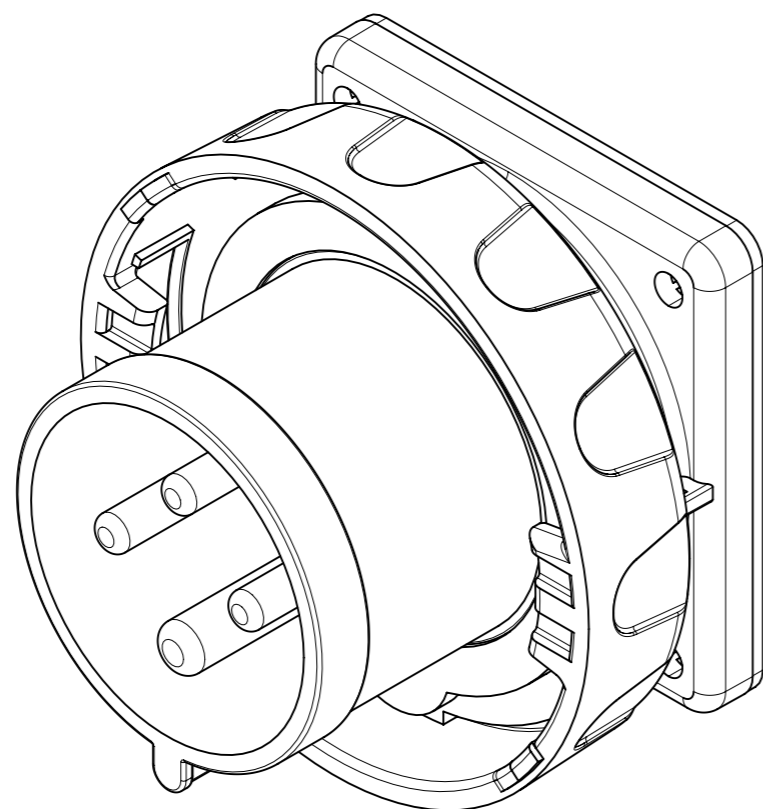

IL DISEGNO SI RIFERISCE ALLA POSIZIONE 6H
DWG REFERS TO CLOCK POSITION 6H

At the end of the law, we reserve the ownership of this design may not be copied and transfer it to third parties or competitors	Format	A3	Scale	1:1	Mould N°	Drawn	SCAME
	Tolerances for linear and angular dimensions without indication of specific tolerances: JS13 / UNI EN20286						Date
 S.p.A. PARRE - (Bergamo)	DESCRIPTION					CODICE Sheet 1 / 1	
	SP.FIS. 3P+T 32A 6H IP66/67 OPTIMA REV.					4000509	