

DIMA DI FORATURA
DRILLING TEMPLATE

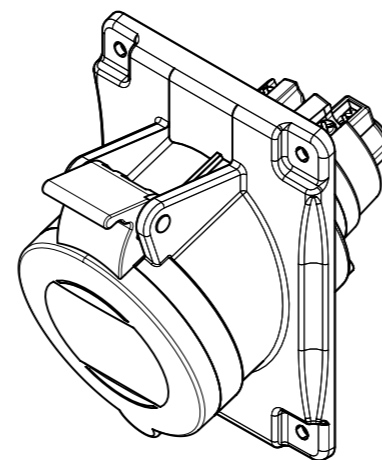
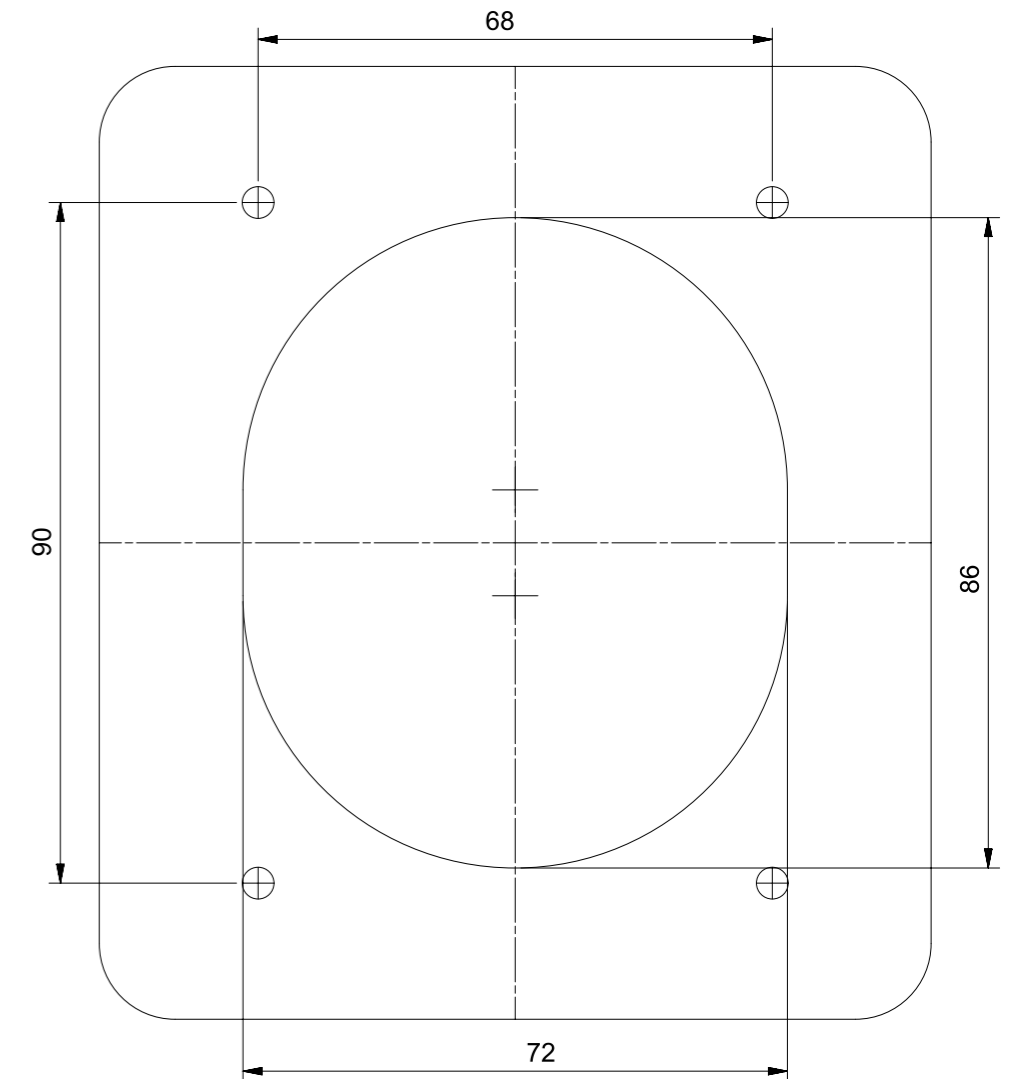
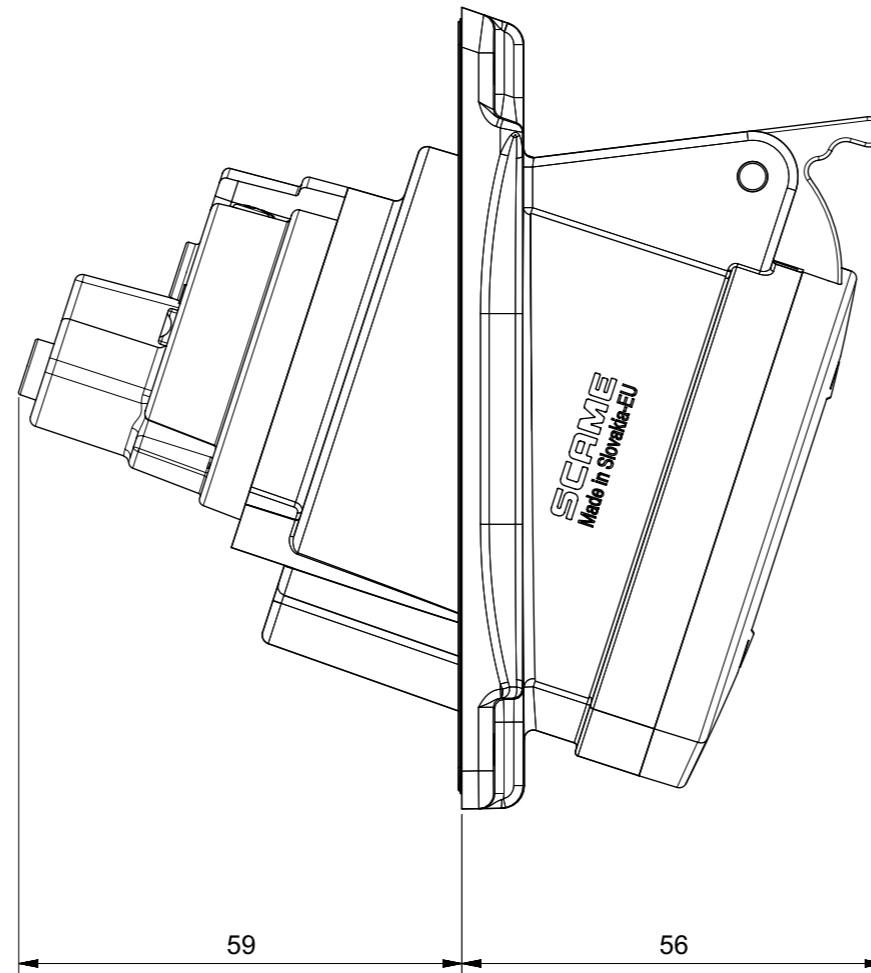
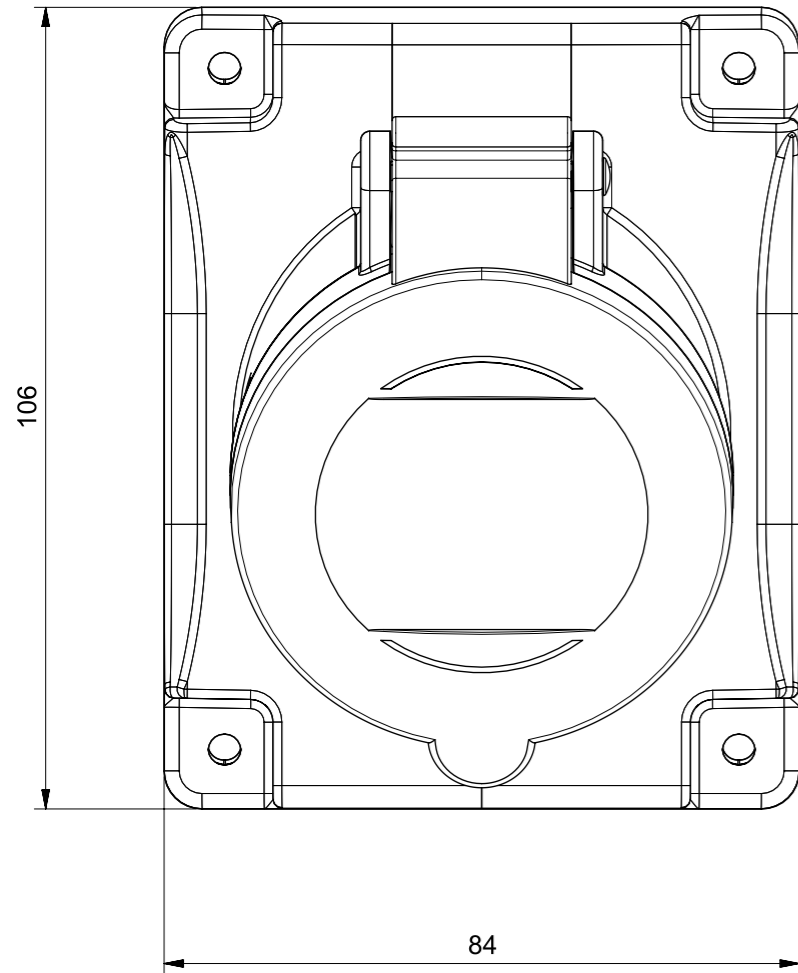

<p>At the end of the law, we reserve the ownership of this design may not be copied and transfer it to third parties or competitors</p> <p>SCAME S.p.A. PARRE - (Bergamo)</p>	Format	A3	Scale	1:1	Mould N°	1000XXXX	Drawn	SCAME	
	Tolerances for linear and angular dimensions without indication of specific tolerances: JS13 / UNI EN20286							Date	
	DESCRIPTION							Approved	
PRESA FISSA 2P+T IP44 32A							CODICE	Sheet 1 / 1	
								4001869	