

DIAMETRO FORATURA PANNELLO
PANEL DRILLING HOLE

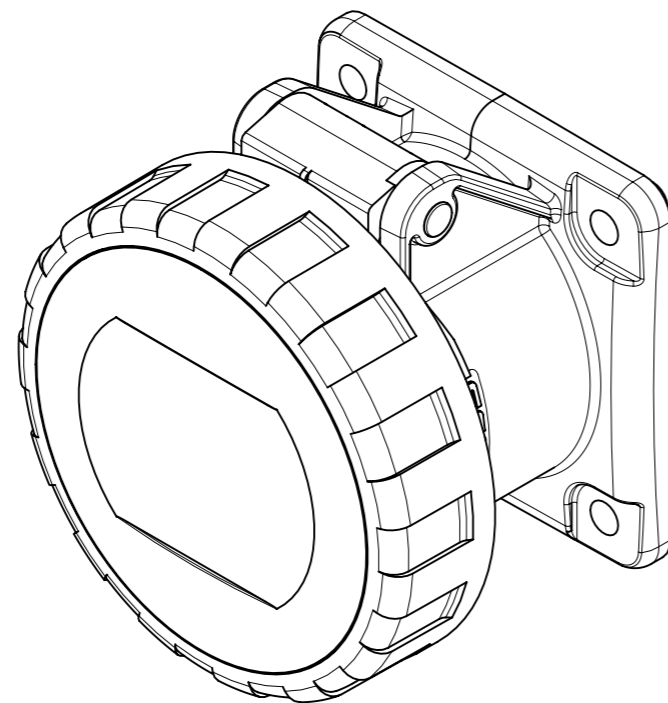
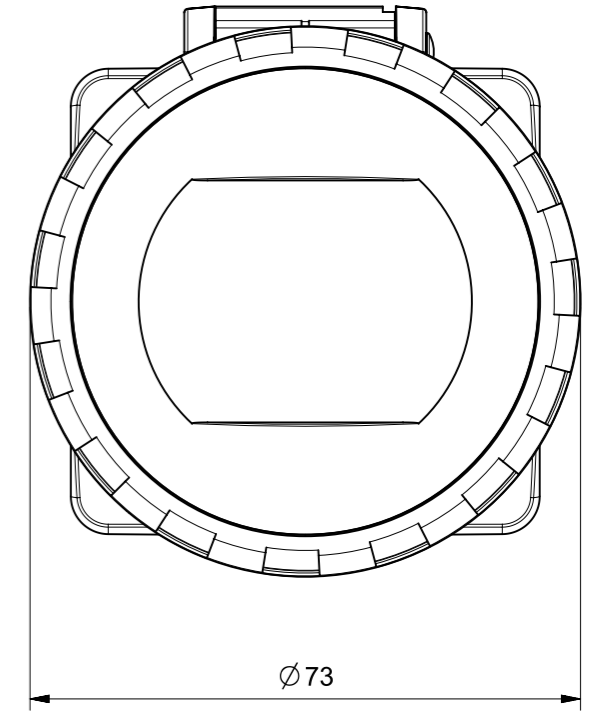
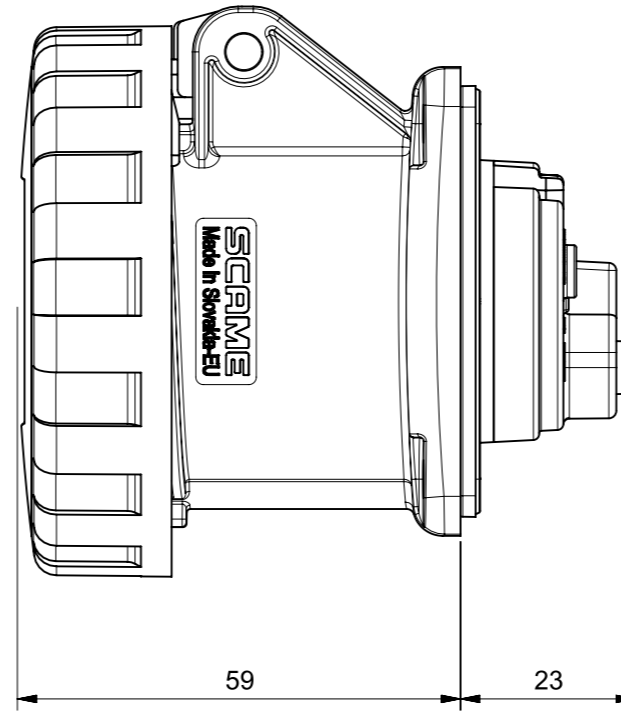

IL DISEGNO SI RIFERISCE ALLA POSIZIONE 6h
DWG REFERS TO CLOCK POSITION 6h

At the end of the law, we reserve the ownership of this design may not be copied and transfer it to third parties or competitors	Format	A3	Scale	1:1	Mould N°		Drawn	SCAME
	Tolerances for linear and angular dimensions without indication of specific tolerances: JS13 / UNI 286-1:2010						Date	gg-mm-aaaa
 S.p.A. PARRE - (Bergamo)	DESCRIPTION						Approved	
	PRESA INC.DIR. 2P+T 16A IP67 FLANGIA 62x62						CODICE	Sheet 1 / 1 4006944