

Sezione B-B

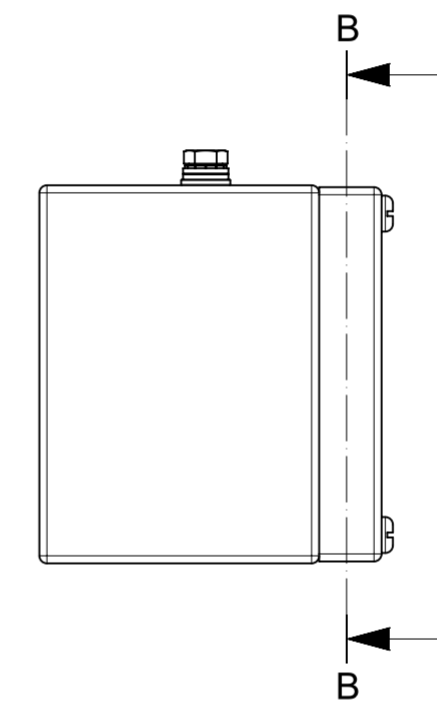

Sezione A-A

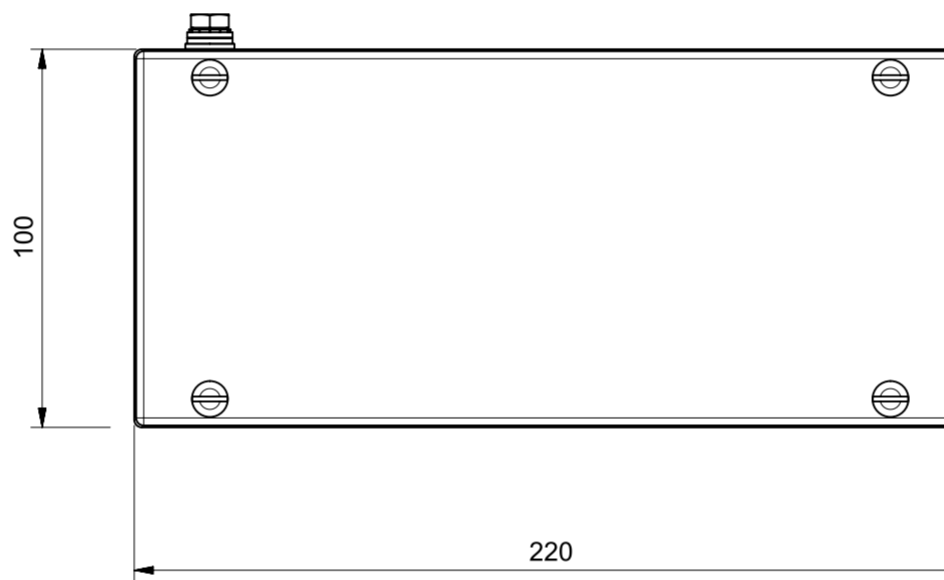
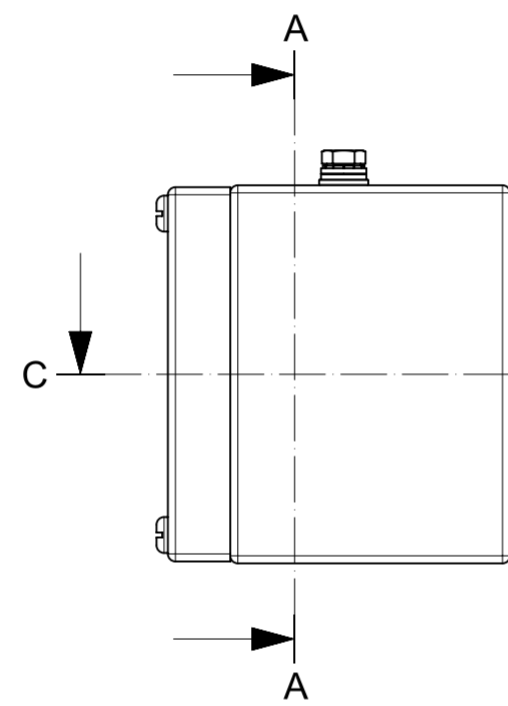
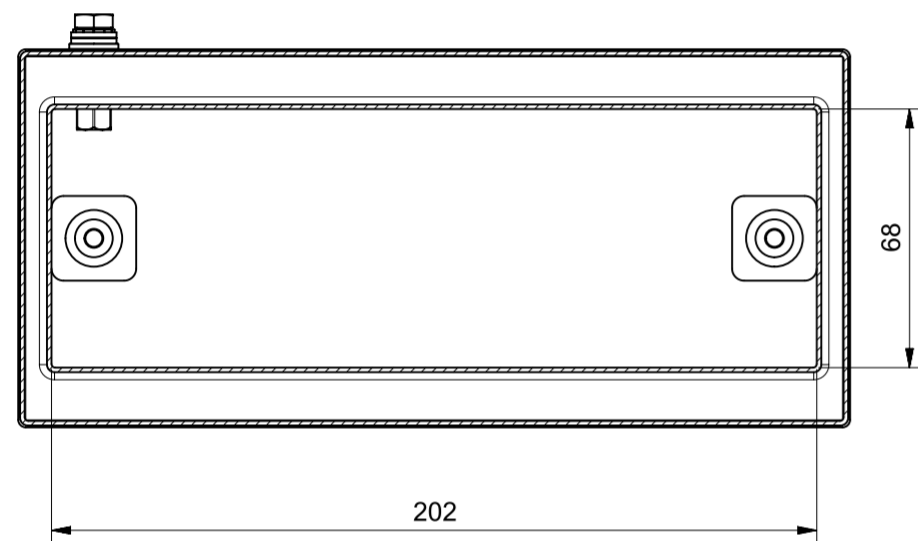
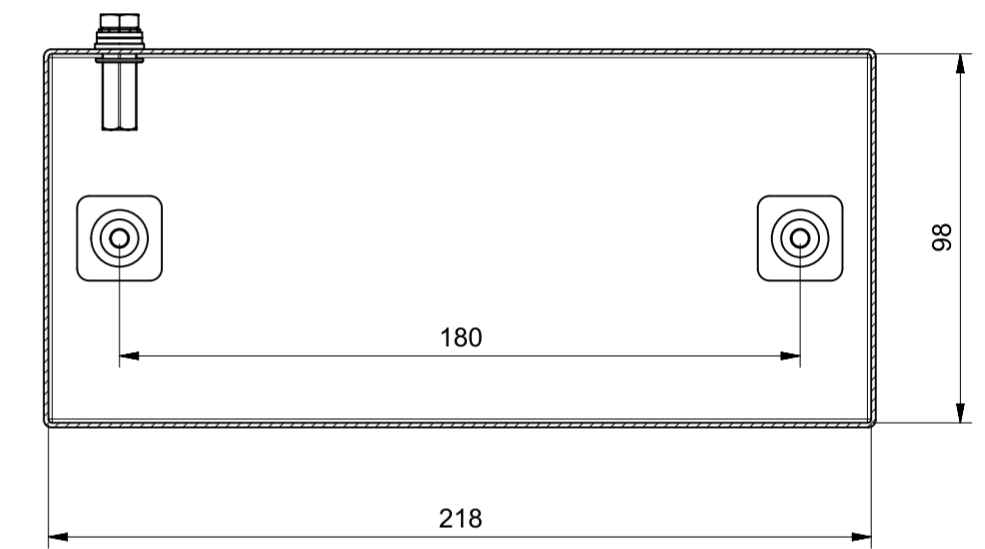

Sezione C-C

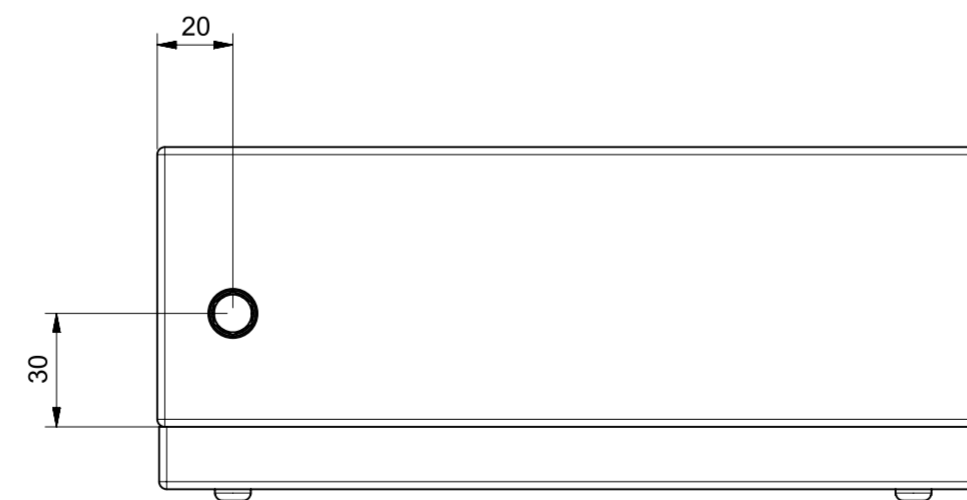
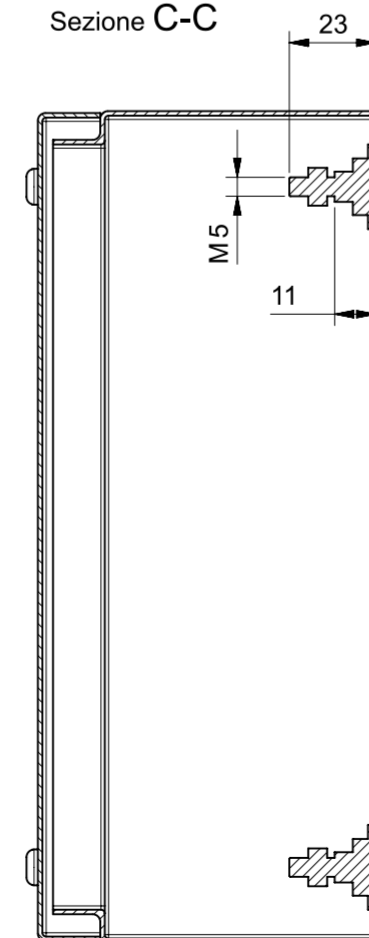

Under the terms of the law we reserve the ownership of this design may not be copied and transfer it to third parties or competitors SCAME S.p.A. PARRE - (Bergamo)	Format	A2	Scale	1:2	Mould N°		Drawn	SCAME	
	Tolerances for linear and angular dimensions without indication of specific tolerances: JS13 / UNI 286-1:2010							Date	
	DESCRIPTION							Approved	
SCATOLA AISI SILICONE 100X220X90							CODE	Sheet 1 / 1	
								4011193	