

Sezione E-E

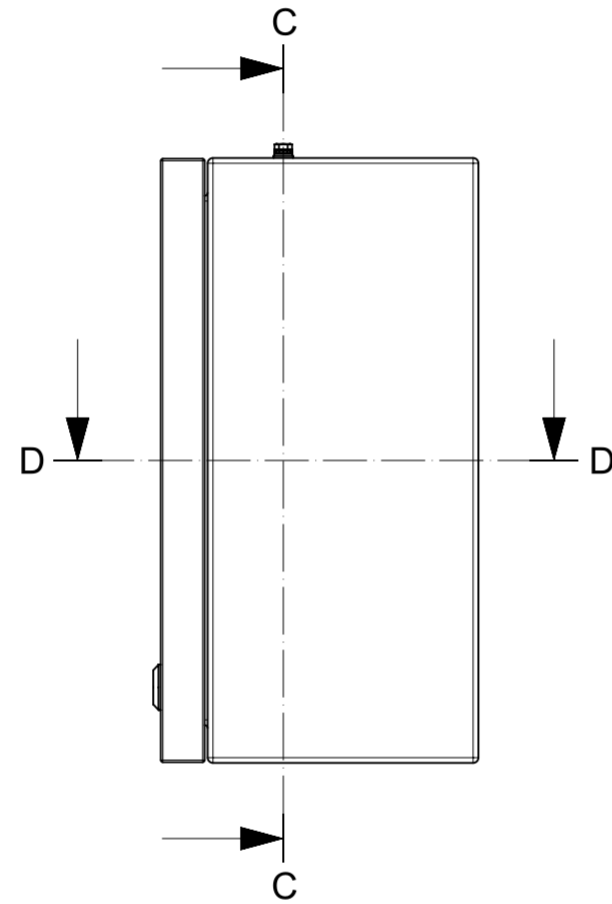

PERNO DI TERRA // EARTH PIN

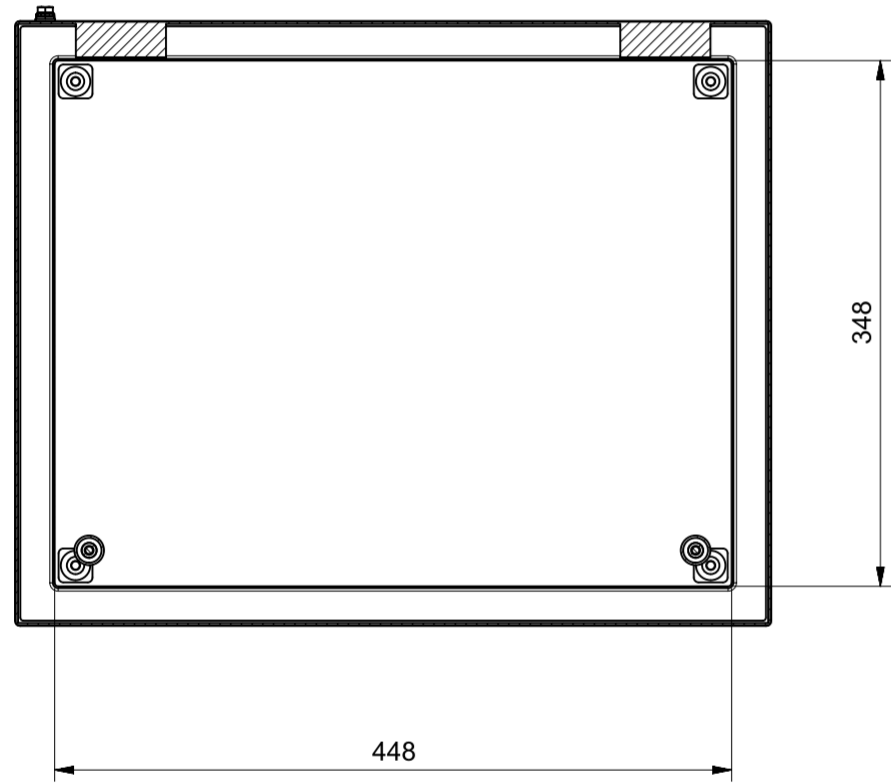
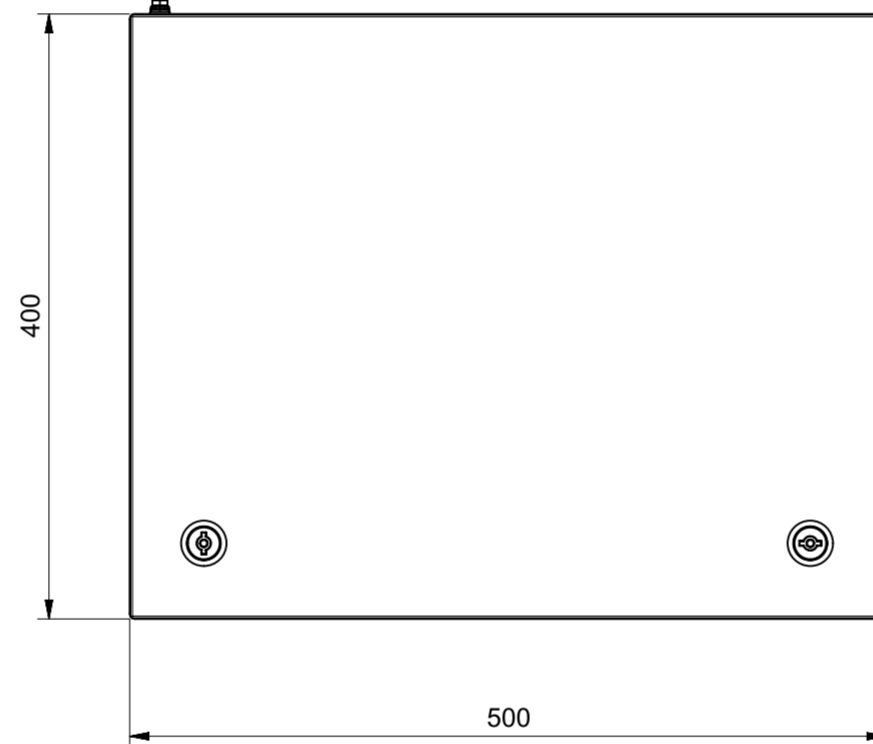

Sezione C-C

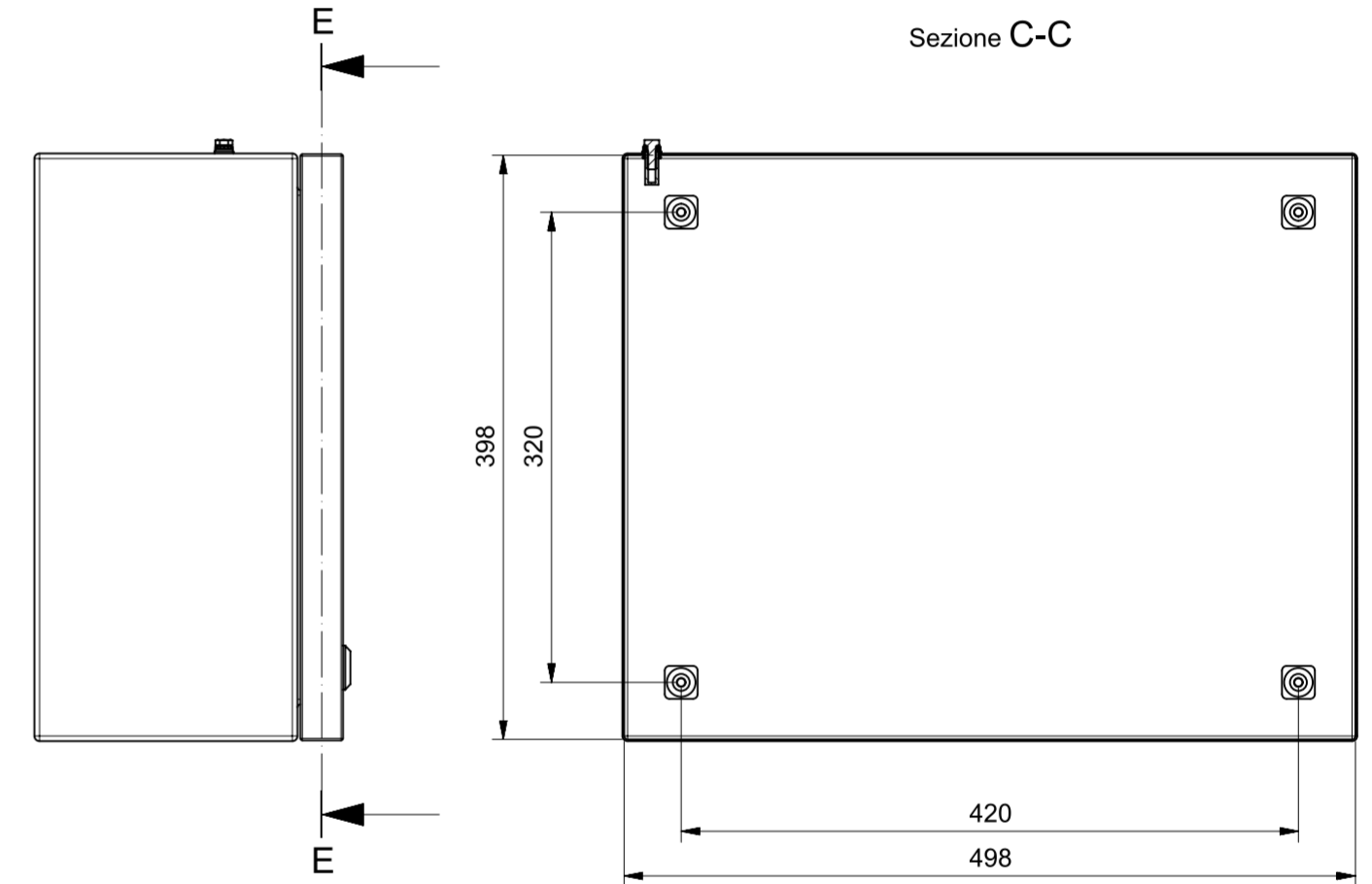

Sezione D-D

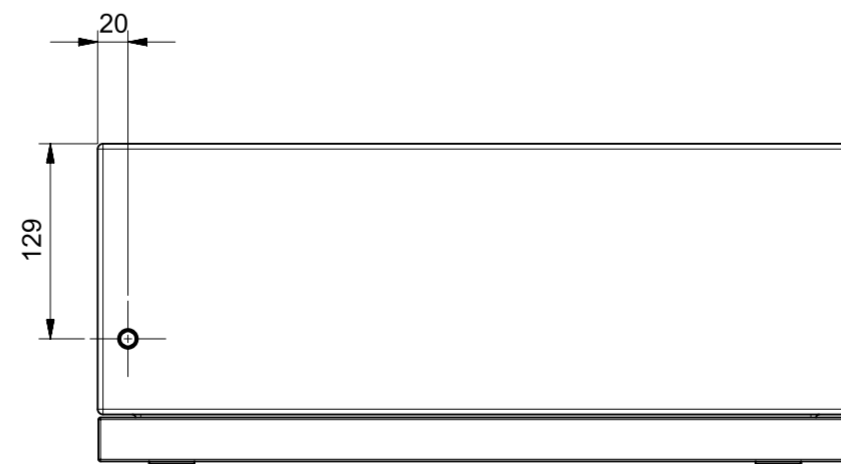
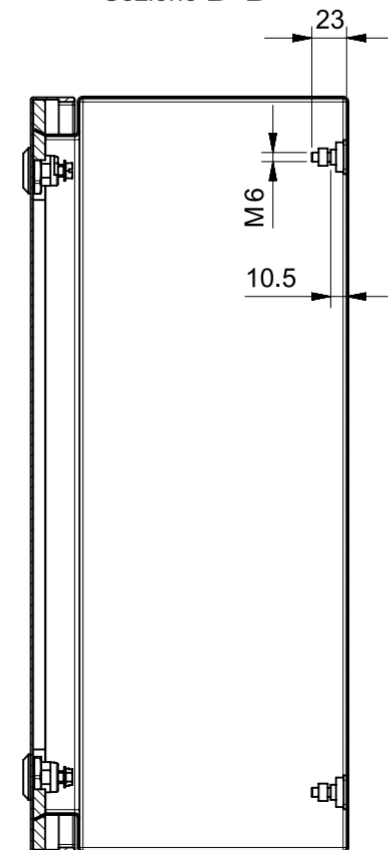

Under the terms of the law we reserve the ownership of this design may not be copied and transfer it to third parties or competitors SCAME S.p.A. PARRE - (Bergamo)	Format	A2	Scale	1:5	Mould N°		Drawn	SCAME	
	Tolerances for linear and angular dimensions without indication of specific tolerances: JS13 / UNI 286-1:2010							Date	
	DESCRIPTION							Approved	
CASSETTA 400x500x210 Zenith-S							CODE	Sheet 1 / 1	
								4011921	