

Sezione D-D

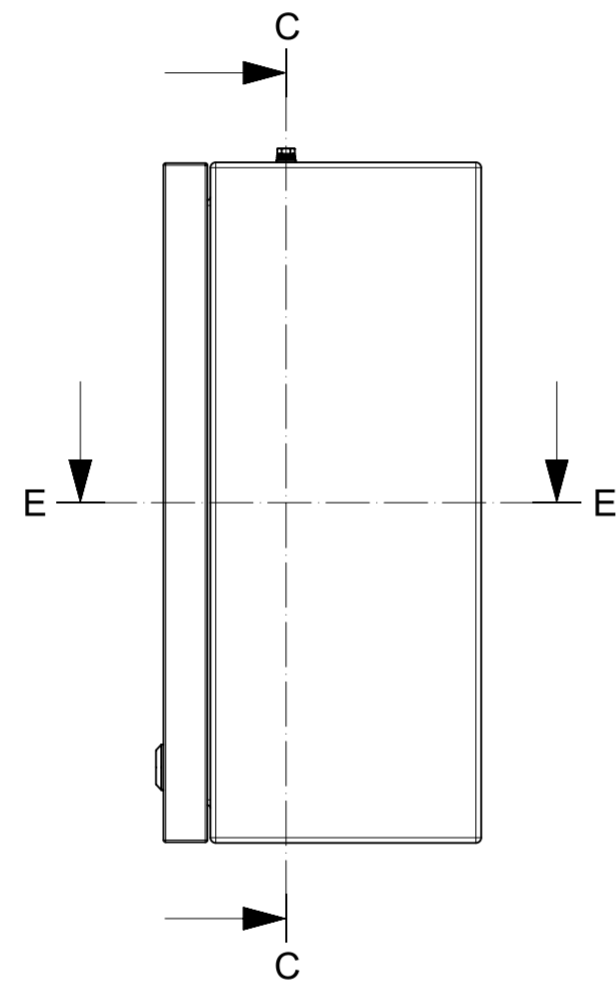

PERNO DI TERRA // EARTH PIN

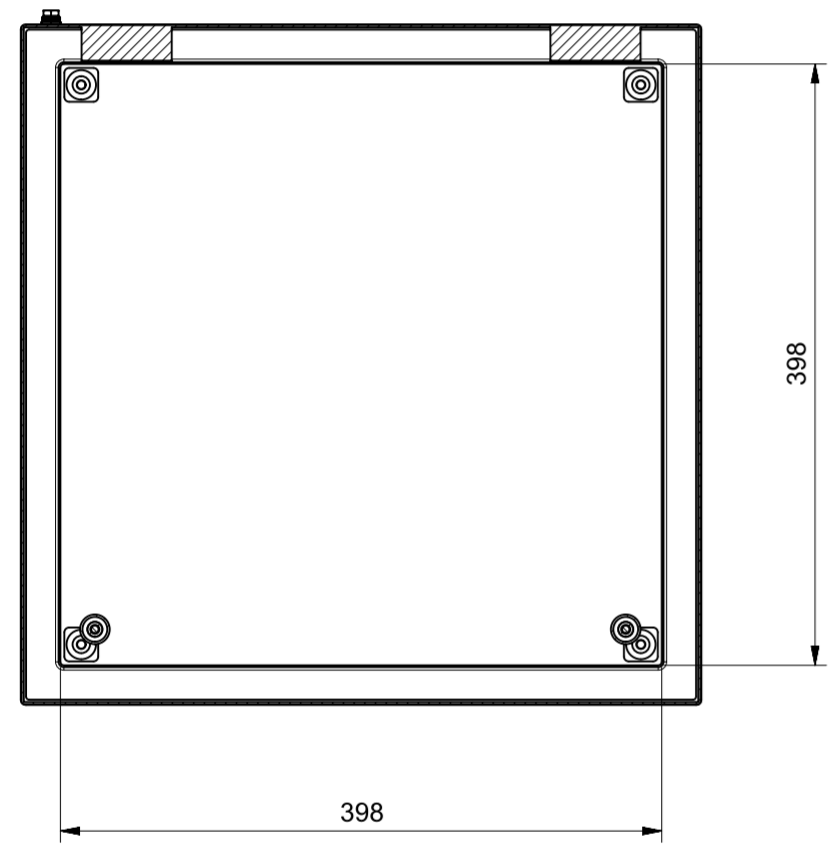
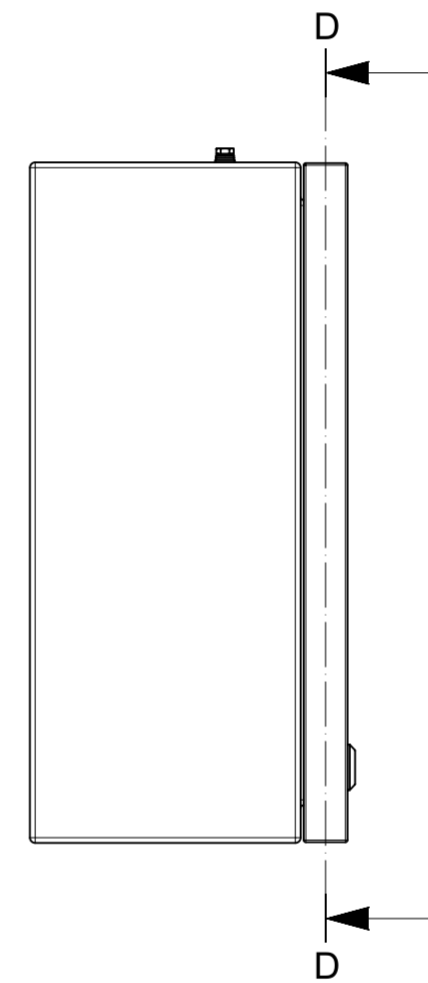
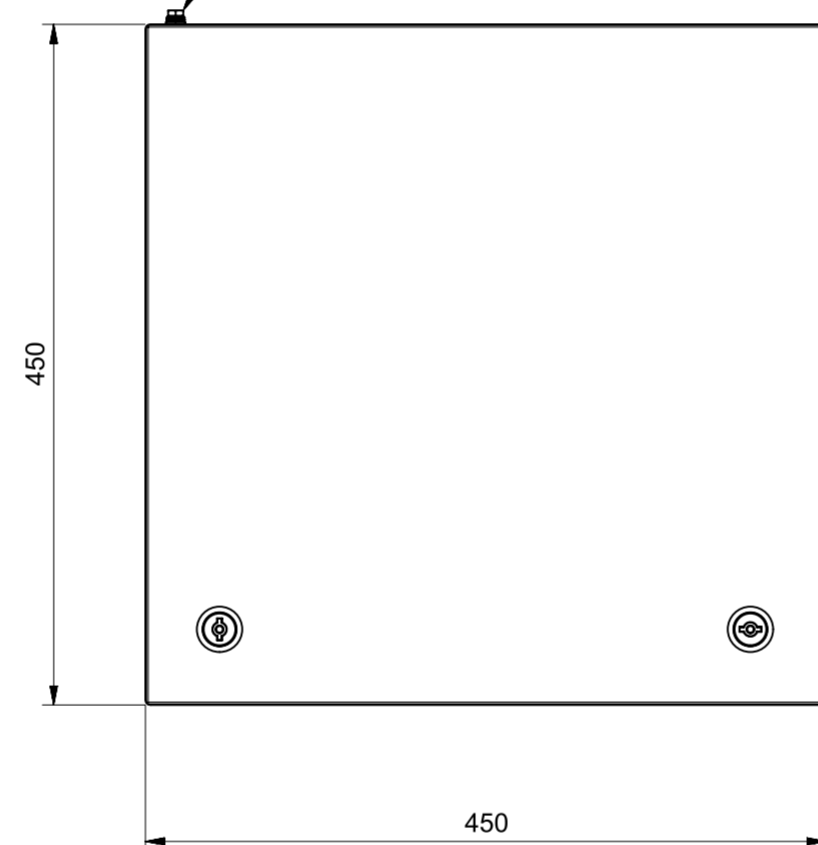

Sezione C-C

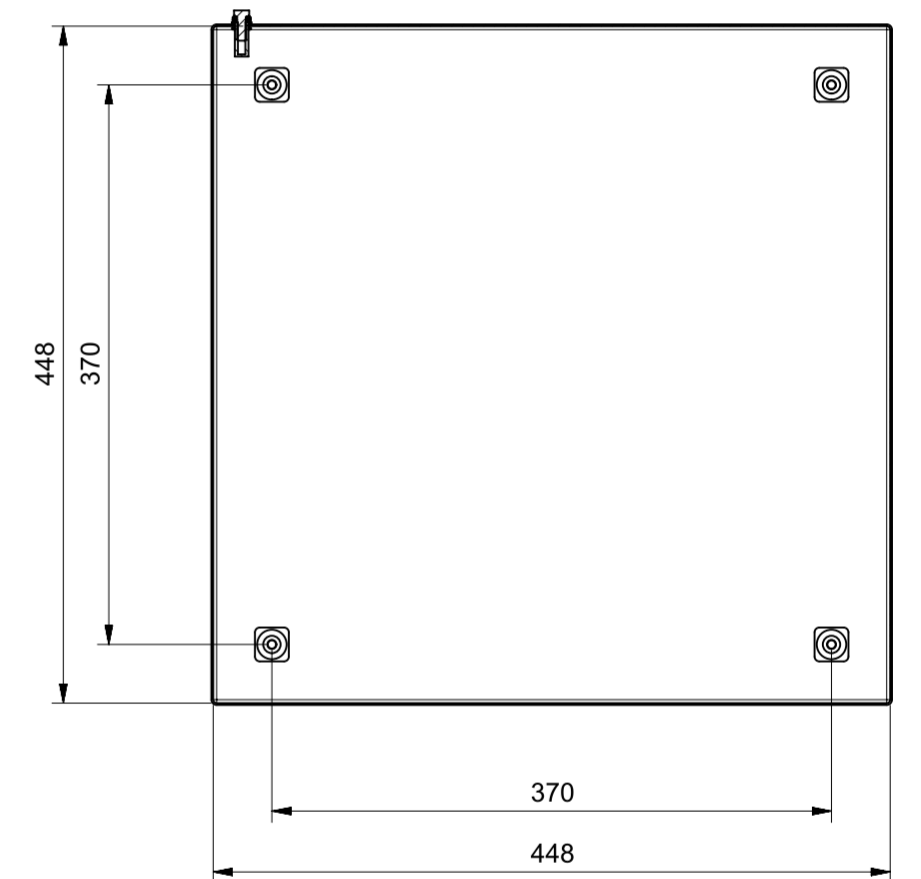

Sezione E-E

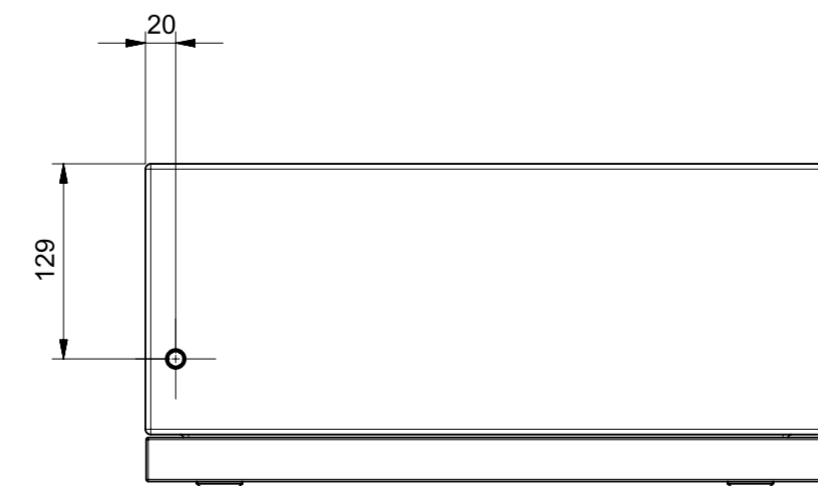
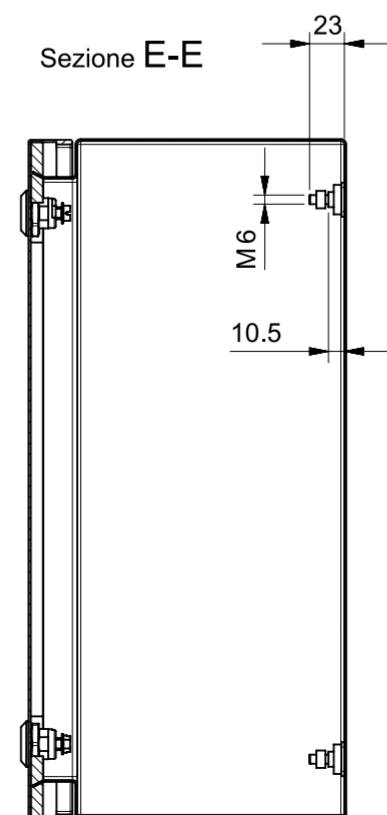

<p>Under the terms of the law we reserve the ownership of this design may not be copied and transfer it to third parties or competitors</p> <p>SCAME S.p.A. PARRE - (Bergamo)</p>	Format	A2	Scale	1:5	Mould N°		Drawn	SCAME	
	Tolerances for linear and angular dimensions without indication of specific tolerances: JS13 / UNI 286-1:2010							Date	
	DESCRIPTION							Approved	
<p>CASSETTA 450x450x210 Zenith-S</p>							CODE	Sheet 1 / 1	
								4011923	