

Under the terms of the law we reserve the ownership of this design may not be copied and transfer it to third parties or competitors	Format	A3	Scale	1:4	Mould N°		Drawn	SCAME	
	Tolerances for linear and angular dimensions without indication of specific tolerances: JS13 / UNI 286-1:2010							Date	
								Approved	
SCAME S.p.A. PARRE - (Bergamo)	DESCRIPTION FLANGIA 264x685						CODICE Sheet 1 / 2 4013934		

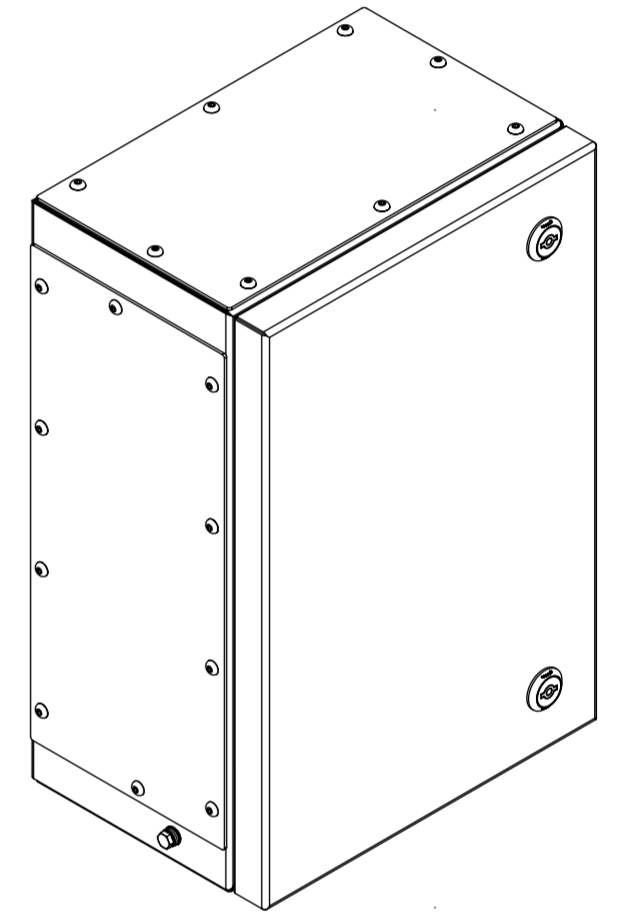
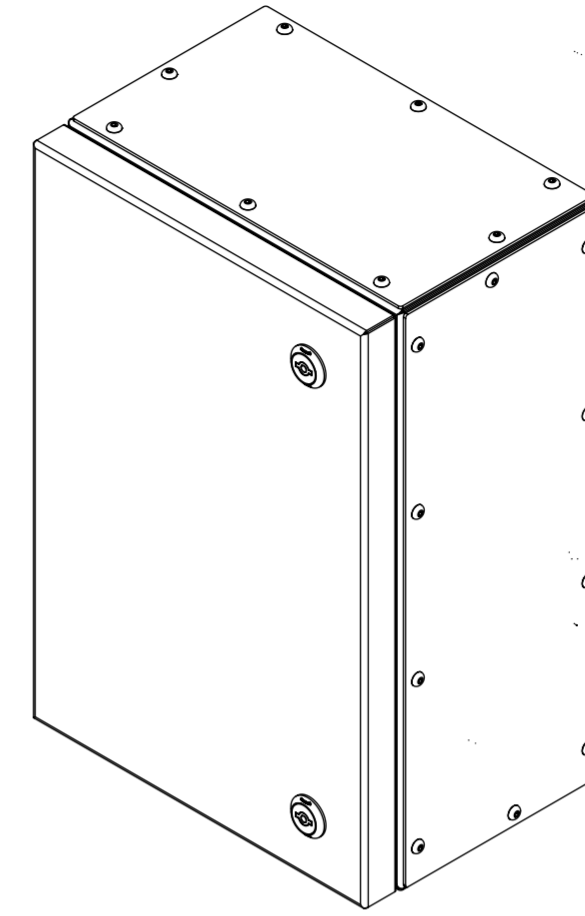
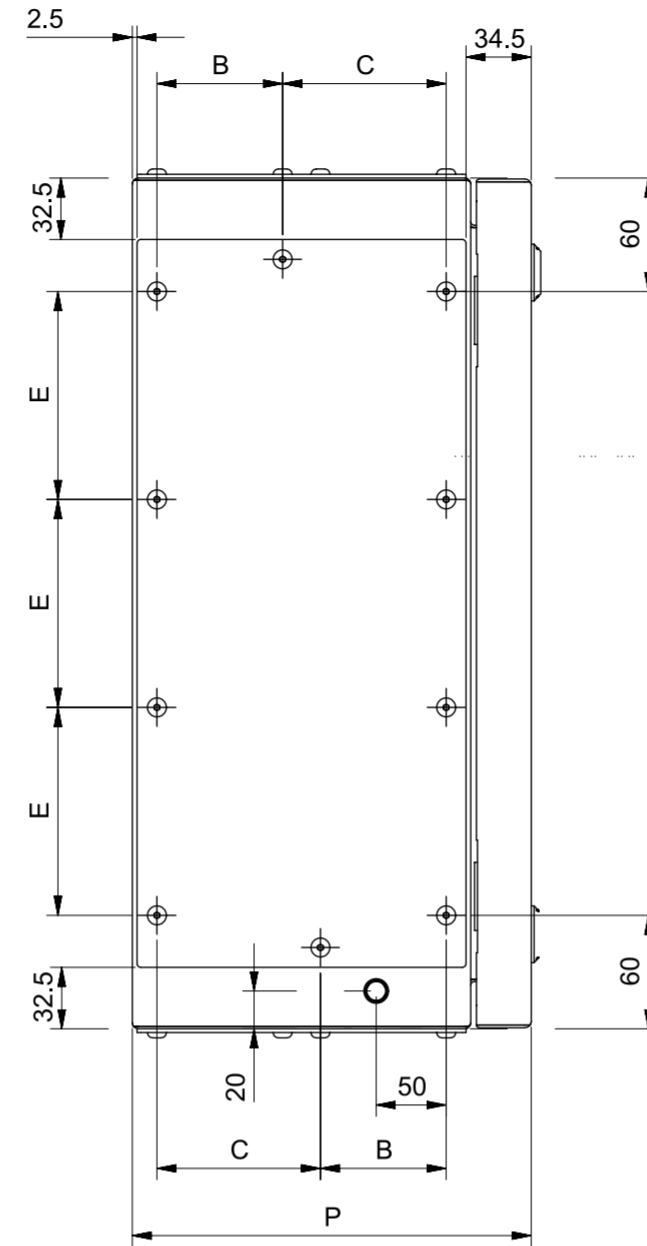
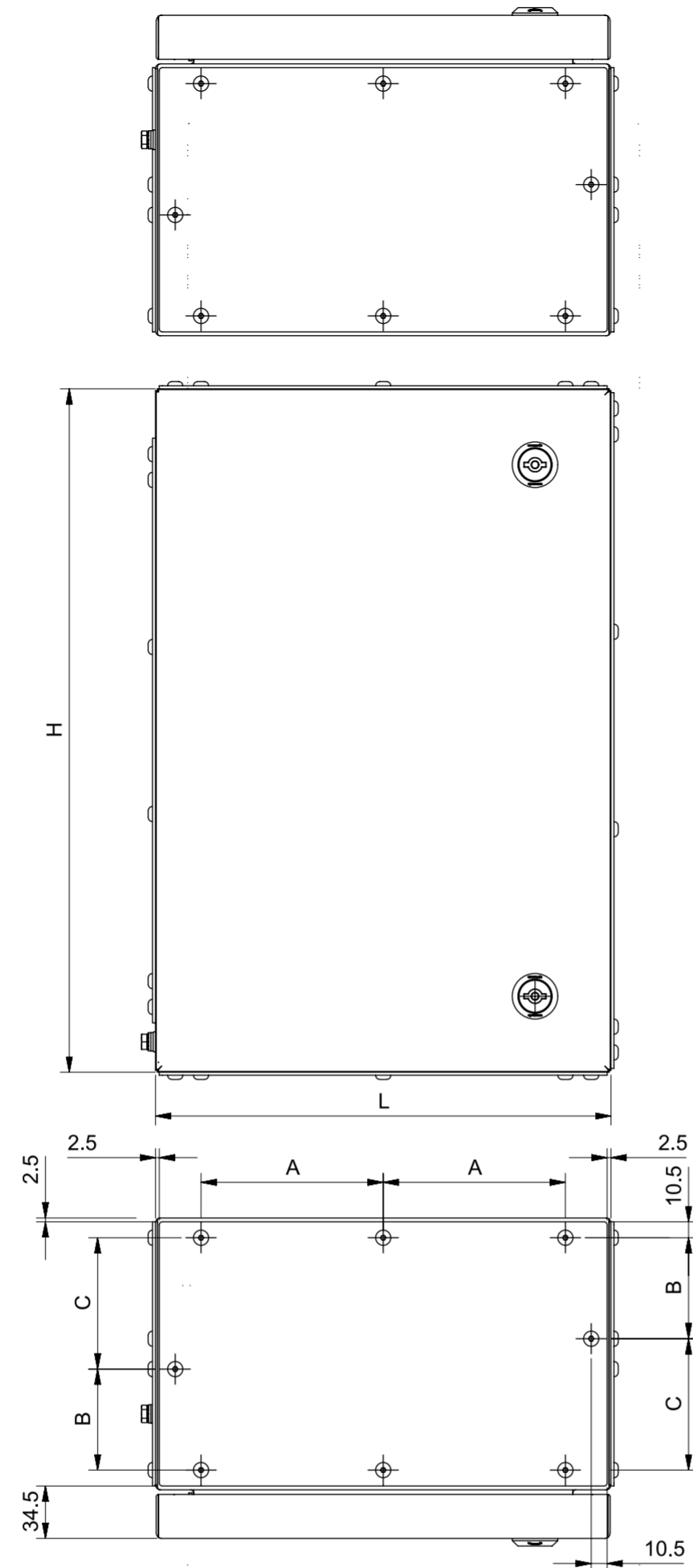
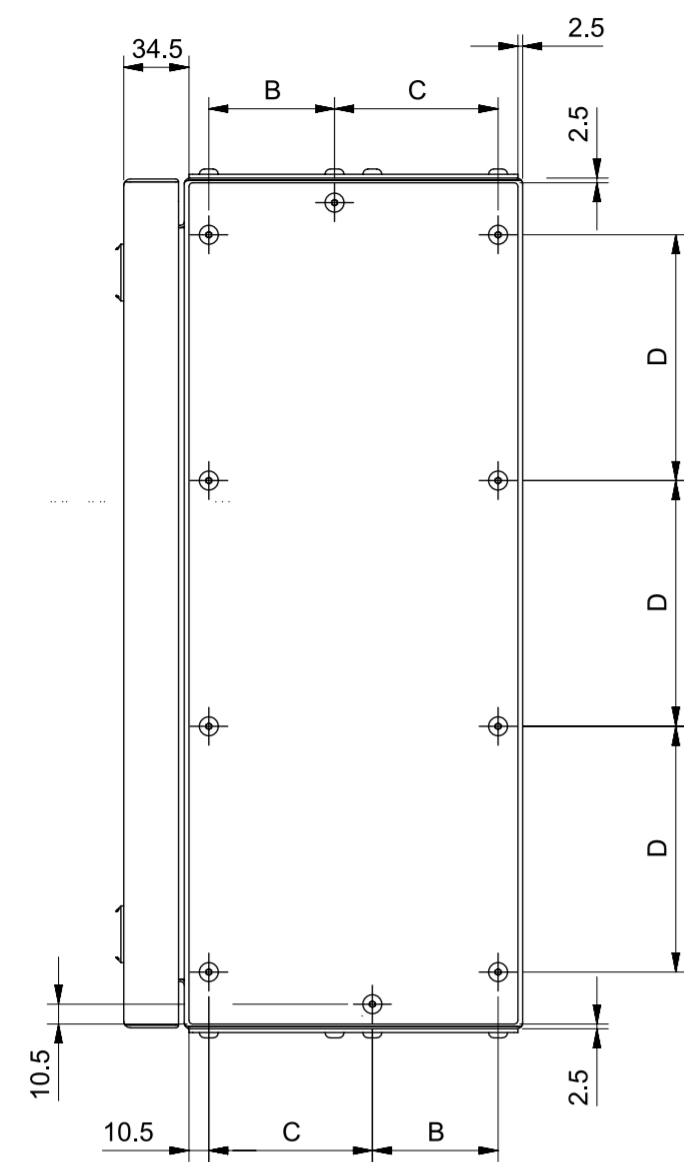

Codice Cassa			Dimensioni		Flangia SUP/INF			Flangia DX			Flangia SX							
LXHX			Dimensioni Flangia	Numero viti	Interasse viti Flangia su lato Lungo (A)	Interasse viti Flangia su lato Corto (B)	Interasse viti Flangia su lato Corto (C)	Dimensioni Flangia	Numero viti	Interasse viti Flangia su lato Lungo (D)	Interasse viti Flangia su lato Corto (B)	Interasse viti Flangia su lato Corto (C)	Dimensioni Flangia	Numero viti	Interasse viti Flangia su lato Lungo (E)	Interasse viti Flangia su lato Corto (B)	Interasse viti Flangia su lato Corto (C)	
645.C4S000	645.C6S000	645.D6S000	260x260x150	114x255	6	100	*	*	114x255	6	100	*	*	114x195	6	70	*	*
645.C4S010	645.C6S010	645.D6S010	300x300x210	174x295	8	120	66,5	86,5	174x295	8	120	66,5	86,5	174x235	8	90	66,5	86,5
645.C4S020	645.C6S020	645.D6S020	300x380x210	174x295	8	120	66,5	86,5	174x375	10	106	66,5	86,5	174x315	8	130	66,5	86,5
645.C4S030	645.C6S030	645.D6S030	300x450x210	174x295	8	120	66,5	86,5	174x445	10	130	66,5	86,5	174x385	10	110	66,5	86,5
645.C4S040	645.C6S040	/	380x300x210	174x375	10	106	66,5	86,5	174x295	8	120	66,5	86,5	174x235	8	90	66,5	86,5
645.C4S050	645.C6S050	645.D6S050	380x380x210	174x375	10	106	66,5	86,5	174x375	10	106	66,5	86,5	174x315	8	130	66,5	86,5
645.C4S060	645.C6S060	/	380x600x210	174x375	10	106	66,5	86,5	174x595	12	135	66,5	86,5	174x535	12	120	66,5	86,5
645.C4S070	645.C6S070	645.D6S070	400x500x210	174x395	10	113	66,5	86,5	174x495	12	110	66,5	86,5	174x435	10	126	66,5	86,5
645.C4S080	645.C6S080	/	450x300x210	174x445	10	130	66,5	86,5	174x295	8	120	66,5	86,5	174x235	8	90	66,5	86,5
645.C4S090	645.C6S090	645.D6S090	450x450x210	174x445	10	130	66,5	86,5	174x445	10	130	66,5	86,5	174x385	10	110	66,5	86,5
645.C4S100	645.C6S100	/	450x450x250	214x445	10	130	86,5	106,5	214x445	10	130	86,5	106,5	214x385	10	110	86,5	106,5
645.C4S110	645.C6S110	645.D6S110	450x600x210	174x445	10	130	66,5	86,5	174x595	12	135	66,5	86,5	174x535	12	120	66,5	86,5
645.C4S120	645.C6S120	/	450x600x250	214x445	10	130	86,5	106,5	214x595	12	135	86,5	106,5	214x535	12	120	86,5	106,5
645.C4S130	645.C6S130	/	500x700x250	214x495	12	110	86,5	106,5	214x695	14	128	86,5	106,5	214x635	14	116	86,5	106,5
645.C4S140	645.C6S140	645.D6S140	600x380x210	174x595	12	135	66,5	86,5	174x375	10	106	66,5	86,5	174x315	8	130	66,5	86,5
645.C4S150	645.C6S150	/	600x450x250	214x595	12	135	86,5	106,5	214x445	10	130	86,5	106,5	214x385	10	110	86,5	106,5
645.C4S160	645.C6S160	645.D6S160	600x600x210	174x595	12	135	66,5	86,5	174x595	12	135	66,5	86,5	174x535	12	120	66,5	86,5
645.C4S170	645.C6S170	/	600x600x250	214x595	12	135	86,5	106,5	214x595	12	135	86,5	106,5	214x535	12	120	86,5	106,5
645.C4S180	645.C6S180	/	600x600x300	264x595	12	135	111,5	131,5	264x595	12	135	111,5	131,5	264x535	12	120	111,5	131,5
645.C4S190	645.C6S190	645.D6S190	600x750x210	174x595	12	135	66,5	86,5	174x745	16	115	66,5	86,5	174x685	14	126	66,5	86,5
645.C4S200	645.C6S200	/	600x750x250	214x595	12	135	86,5	106,5	214x745	16	115	86,5	106,5	214x685	14	126	86,5	106,5
645.C4S210	645.C6S210	/	600x750x300	264x595	12	135	111,5	131,5	264x745	16	115	111,5	131,5	264x685	14	126	111,5	131,5
645.C4S220	645.C6S220	645.D6S220	600x900x300	264x595	12	135	111,5	131,5	264x895	18	120	111,5	131,5	264x835	16	130	111,5	131,5
645.C4S230	645.C6S230	645.D6S230	750x1000x300	264x745	16	115	111,5	131,5	264x995	20	117,5	111,5	131,5	264x935	20	110	111,5	131,5
645.C4S240	645.C6S240	645.D6S240	800x1200x300	264x795	16	123	111,5	131,5	264x1195	22	126	111,5	131,5	264x1135	22	120	111,5	131,5

Spessore flange 2mm

Under the terms of the law we reserve the ownership of this design may not be copied and transfer it to third parties or competitors SCAME S.p.A. PARRE - (Bergamo)	Format	A2	Scale	1:4	Mould N°		Drawn	SCAME	
	Tolerances for linear and angular dimensions without indication of specific tolerances: JS13 / UNI 286-1:2010							Date	
	DESCRIPTION							Approved	
FLANGIA 264x685							CODE	Sheet 2 / 2	
								4013934	