

LUNGHEZZA STANDARD BARRE 2 m

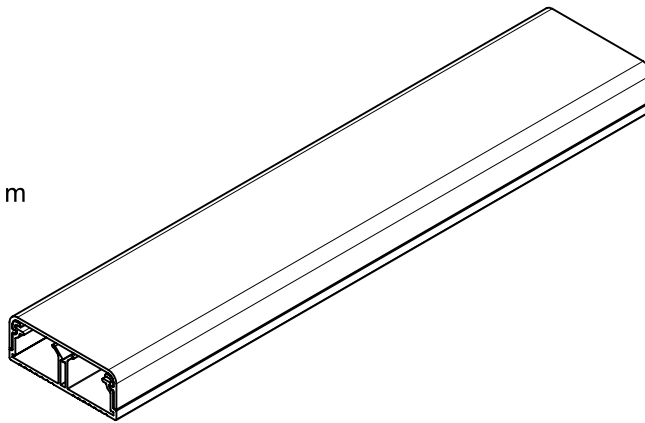

<p>At the end of the law, we reserve the ownership of this design may not be copied and transfer it to third parties or competitors</p> <p>SCAME S.p.A. PARRE - (Bergamo)</p>	Format	A4V	Scale	2:1	Mould N°	1000XXXX	Drawn	SCAME	
	Tolerances for linear and angular dimensions without indication of specific tolerances: JS13 / UNI 286-1:2010							Date	gg-mm-aaaa
								Approved	
DESCRIPTION							CODE	Sheet 1 / 1	
MINICANALE COPERCHIO AVVOLGENTE 40X15							4007186		