

Panasonic



2016 - 2017
Panasonic
Modular
Catalogue

Panasonic

Index

Modular Introduction



P06



Thea
ultima

P14



Thea
sistema

P18



Thea
optima

P22

technical pages

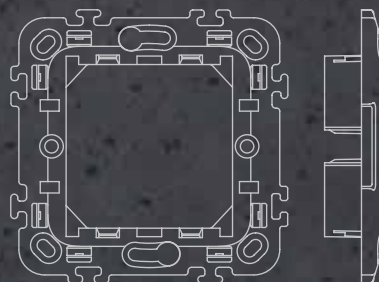

P60

Welcome to Thea Modular World...

Be ready to meet modular products that will make your life easier with advanced Panasonic technology and exclusive designs. One of the Thea Modular series bringing different needs together in the same frame is absolutely for you...



Thea ultima

Ultima modular series distinguishing itself with Glass, Eloxal, Metallic and Wooden frames brings Panasonic quality, modernity and comfort to your living spaces.

Panasonic



Thea sistema

Sistema modular series, the world of frames with zamak alloys, is inviting you to draw all the attention. Panasonic interprets the privileges of modular products again with its own concept.

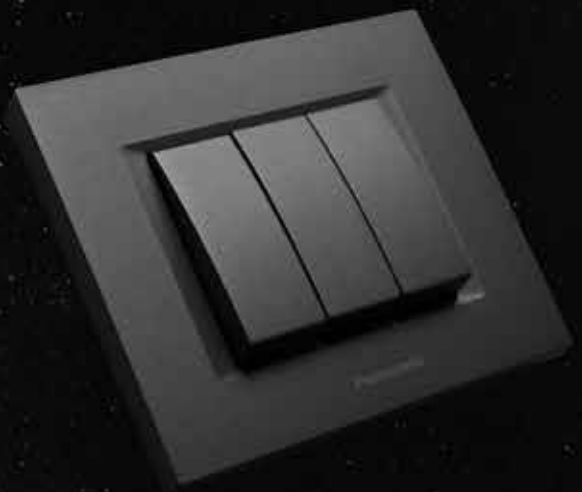

Thea optima

Discover Panasonic quality and refined elegance behind this simple appearance. Hard-edged frames open the doors of modular world widely.

More
function
more design



Thea introduces the advantages of modular system to the users. With Ultima, Sistema and Optima having modular mechanisms and different forms, Thea brings freedom of choice to the living spaces.

Panasonic

Thea
Modular



Thea
ultima



Thea
sistema

Thea
optima



Connect to the technology with modular series



Thea's approach to design communes with modular concept. With USB connector, USB charger, HDMI connector, VGA connector and RCA connector, Thea adds the advantages of technology to make the life easier among the options it offers.

1 **Thea Modular USB Charger**

A new period for charging without adapter starts with Thea Modular USB charger in hotel, home, office. Meet Thea Modular USB charger and get rid of the excesses. Thea Modular USB charger introduces you the direct charging comfort through USB cable without adapter. On the other side, 2 separate devices can be simultaneously charged with 5V 2A power output and 2 USB socket output of Thea Modular USB charger.

2 **Thea Modular RCA Connector**

New member of Thea family, Thea Modular RCA Connector eliminates the stress of searching for input on the devices for audio and image transfers. Now it's easier and more comfortable to connect to the device whatever you want with Thea Modular RCA Connector.

Thea
Modular



3 Thea Modular HDMI Connector

New modular HDMI module of Thea family brings the facilities to your office, meeting room, hotel or home. Thanks to Thea Modular HDMI Connector, you will meet the comfort of making the connection to projection device, computer or television from the closest and single point and you will get rid of the extra cables causing visual pollution. The only thing to do for that is to make connection inside the wall to Thea Modular HDMI Connector from the device required for HDMI connection.

4 Thea Modular VGA Connector

What about making VGA connections over the socket on your wall? Insert VGA cable to the new Thea Modular VGA Connector and start the image transfer within seconds.

5 Thea Modular USB Connector

Stop searching for USB input on the television or screen with Thea Modular USB Connector! USB connection that you seek for all of your documents to reflect on the screen from your device in hotel, meeting room or home is as close as Thea Modular USB Connector socket on your wall. Mount Thea Modular USB Connector on the closest accessible point and make the necessary connection to the device you want to use from the modular set. Remove all challenges and obstacles from your life with Thea.

A forward-looking perspective on modular design

Frame

An exclusive and rich range of modular frame options provided by Ultima, Sistema and Optima models steer the decorations.

Cover Plate / Rocker

Different colored switching modules are distinctively combined in Italian style to appeal to those having a hard time to choose.

Modular Mechanism

Modular mechanisms developed for switch, socket, TV/DATA, dimmer, electronic products depending on use serve for the maximum satisfaction of the users.

Modular Wallbox and Mounting Frames

Halogen Free modular boxes suitable for walls varying as concrete and drywall and mounting frames suitable for use draw the borders of impeccability of modular series.

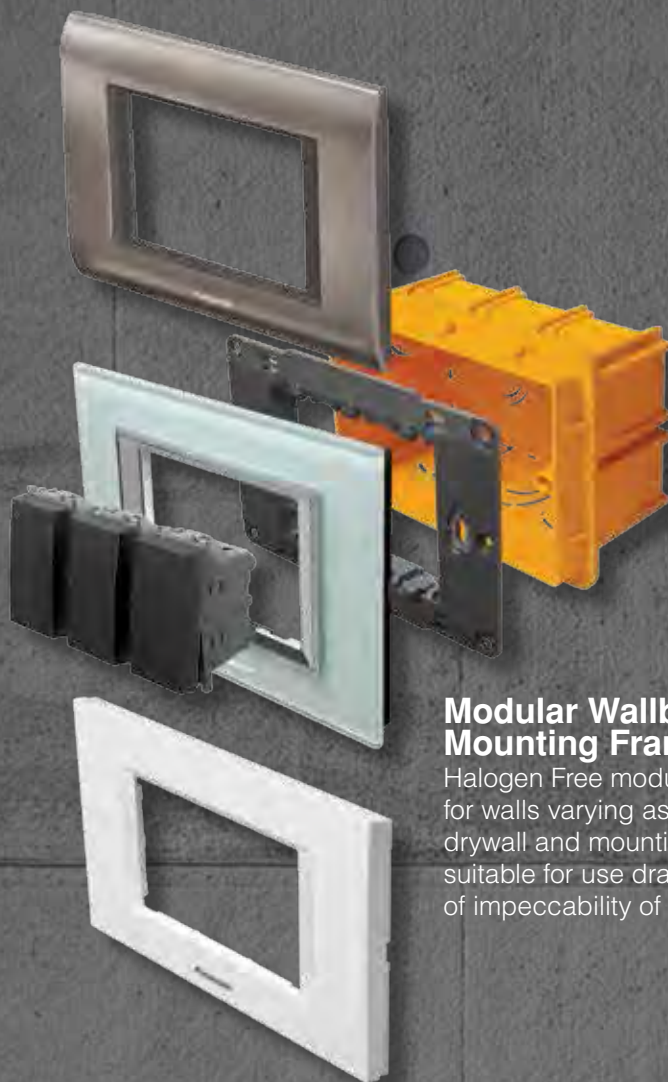



2M Mounting Frames

Metal mounting frames ensuring additional strength comparing to regular mounting frames for challenging assembly conditions. Complying with drywall and flush-mounted cases, the design developed for high-performance operation of all modular products.

2M Earthed Socket

16A, 250V double pole and earthing contact, child protection, screw connection.



1M Switch Mechanism

Modular mechanisms with screw connection suitable for 16AX, 250V.

Thea
ultima

Chasing
your dreams



Panasonic



Thea Ultima is able to make your dreams come true with its different color and material frame alternatives. Make a room for the privilege of using switch, dimmer, socket, TV, satellite, network socket modules together on eye-catching frames.

Thea
ultima

Modular design's outstanding colors

Glass



White



Light Green



Black



Claret Red

Ultima offers alternatives with white, light green, black and claret red color options to the ones who want to catch the Italian sparkle coming with glass.

Metallic



Gold



Chrome



Inox



Una

Ultima Metallic frames bringing qualification to furniture and accessories of modern environments catches the integrity in details.





Eloxal



Silver



Bronze



Black

Modern elegance is taking the center stage of living spaces with Ultima Eloxal frames.

Wooden



Bamboo



Walnut



Wenge

Ultima Wooden frames offering wenge, walnut, bamboo alternatives add their own warmth to all spaces.



Thea
sistema

For most impressive
decorations





Metropolitan life continues to steer the decorations considered for living spaces. Thea Sistema offering most impressive design alternatives with 14 different color options, provides the benefit of modularity in living spaces.

Designs having a voice, colors above-the-line



Inox

Sistema frames reflecting the power of zamak alloy determines the preferences with Inox option.

Inox Matt

Modular system concept of Sistema makes dream come true with Inox Matt frames.

Chrome

Spaces gain originality and reflect the style of the owner with Sistema Chrome frames.





Chrome Matt

Sistema Chrome Matt option leaves visible excesses out of frame.



Una

Sistema accompanies to the ones who say each space should have a story with Una frames.



Antique

Sistema makes an elegant and inspiring offer to the ones with special liking through Antique frames.



Gold

Sistema Gold frames give a bright touch on living spaces that will leave a mark.



Thea
optima

Simplicity taking
the first step



Panasonic



Simplicity taking the center stage with Optima, combining various switching modules. With dimmer products, TV, satellite, network socket solutions, child protected modular sockets, Optima exhibits its difference.

Thea
optima

Optima style,
Optima simplicity

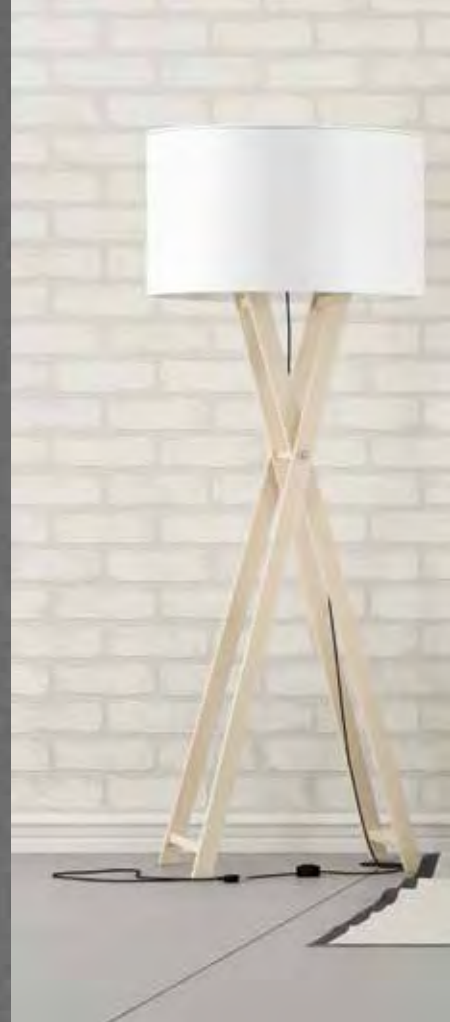

Panasonic

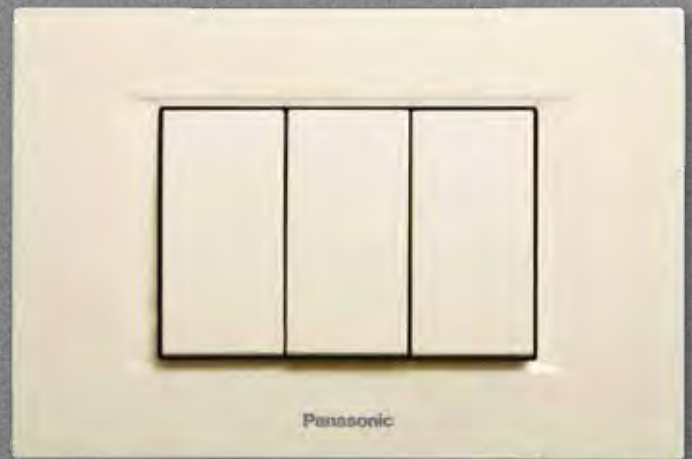
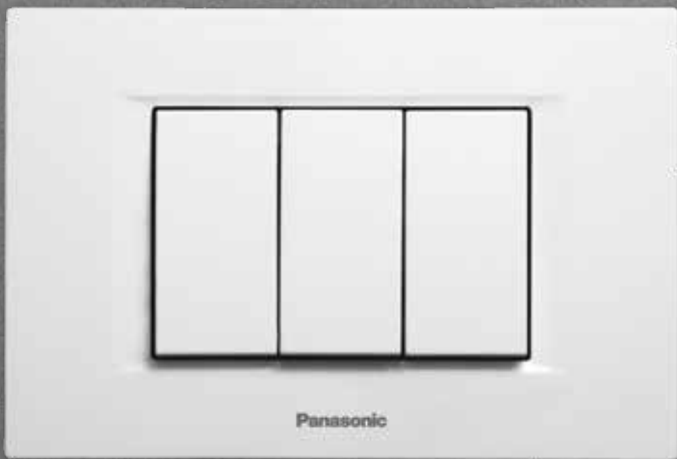

Discover the Optima touch with a catchy form on white and beige color options. Aesthetic attitude accompanying the feeling of comfort brings a modern and exclusive appearance to the living spaces. They invite the ones who prefer primarily minimal designs to the world of Optima in modular switch and socket applications.

Thea
optima

Power of colors,
decoration privileges



White



Beige

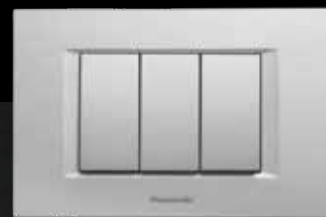

Metallic White

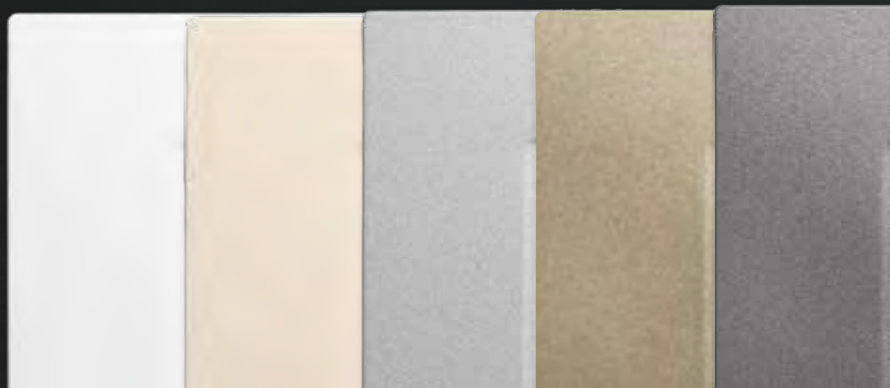



Dore



Hard Coal



Dark Gray



Black

Optima reflects the elegance of modular design on everyday life with White, Metallic White, Beige, Dore, Hard Coal, Dark Gray and Black color options. Optima largely meets the expectations with modern colors for modern decorations. Each preferred Optima serves for the happiness of the users.

Switches

Switch

Mechanism+Rocker 1M **Mechanism+Rocker 2M**
 WVTT1001-9 WVTT2001-9



16AX, 250V~
Screw Terminal



Switch, Illuminated

Mechanism+Rocker 1M **Mechanism+Rocker 2M**
 WVTT1002-9 WVTT2002-9



16AX, 250V~
Screw Terminal



Two-way Switch

Mechanism+Rocker 1M **Mechanism+Rocker 2M**
 WVTT1003-9 WVTT2003-9



16AX, 250V~
Screw Terminal



Two-way Switch, Illuminated

Mechanism+Rocker 1M **Mechanism+Rocker 2M**
 WVTT1004-9 WVTT2004-9



16AX, 250V~
Screw Terminal



Intermediate Switch

Mechanism+Rocker 1M **Mechanism+Rocker 2M**
 WVTT1005-9 WVTT2005-9



16AX, 250V~
Screw Terminal



Intermediate Switch, Illuminated

Mechanism+Rocker 1M **Mechanism+Rocker 2M**
 WVTT1006-9 WVTT2006-9



16AX, 250V~
Screw Terminal



2-pole Switch

Mechanism+Rocker 1M **Mechanism+Rocker 2M**
 WVTT1007-9 WVTT2007-9



16AX, 250V~
Screw Terminal



2-pole Switch, Illuminated

Mechanism+Rocker 1M **Mechanism+Rocker 2M**
 WVTT1008-9 WVTT2008-9



16AX, 250V~
Screw Terminal



One-way Push Button

Mechanism+Rocker 1M **Mechanism+Rocker 2M**
 WVTT1016-9 WVTT2016-9



16A, 250V~
Screw Terminal



Push Button, Illuminated

Mechanism+Rocker 1M **Mechanism+Rocker 2M**
 WVTT1017-9 WVTT2017-9



16A, 250V~
Screw Terminal



Push Button with Bell Symbol

Mechanism+Rocker 1M **Mechanism+Rocker 2M**
 WVTT1019-9 WVTT2019-9



16A, 250V~
Screw Terminal



Push Button with Bell Symbol, Illuminated

Mechanism+Rocker 1M (250V~) **Mechanism+Rocker 2M** (250V~)
 WVTT1020-9 (24V) WVTT2020-9 (24V)
 WVTT1046-9 WVTT2046-9





16A, 250V~
Screw Terminal

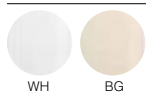

Rocker Color Alternatives



Type of Terminals and Electrical Cables	Solid Wire	Stranded Wire	Flexible Wire
 Screw Terminal	1,0-2,5mm ²	1,0-2,5mm ²	—
 Screw Terminal	1,5-2,5mm ²	1,5-2,5mm ²	—

Switches

Shutter Control Switch

Mechanism+Rocker 1M **Mechanism+Rocker 2M**
 WVTT1023-9 WVTT2023-9



10AX, 250V~
Screw Terminal



Shutter Control Push Button

Mechanism+Rocker 1M **Mechanism+Rocker 2M**
 WVTT1045-9 WVTT2045-9



10A, 250V~
Screw Terminal



Emergency Push Button with Cord

Mechanism+Rocker 1M
 WVTT1025-9



16A, 250V~
Screw Terminal



Blank Cover

Cover Plate 1M
 WVTR1701-4



Cable Outlet

Cover Plate 1M
 WVTR1702-4



Dimmers

PRO Dimmer R 6-100W •

Mechanism+Cover Plate 1M
 WVTT1520-9



230V~
Screw Terminal



PRO Dimmer R 20-300W

Mechanism+Cover Plate 1M
 WVTT1565-9



230V~
Screw Terminal



PRO Dimmer RC 20-300W 

Mechanism+Cover Plate 1M
 WVTT1521-9



230V~
Screw Terminal



Rotary Dimmer 1-10V •

Mechanism+Cover Plate 2M
 WVTT2527-9



230V~
Screw Terminal



Rocker/Cover Plate Color Alternatives



Type of Terminals and Electrical Cables	Solid Wire	Stranded Wire	Flexible Wire
 Screw Terminal	1.0-2.5mm ²	1.0-2.5mm ²	—
 Screw Terminal	1.5-2.5mm ²	1.5-2.5mm ²	—

Sockets

Socket 2P

Mechanism+Cover Plate 1M
WVTT1211-9



16A, 250V~
Screw Terminal, Child Protection



Italian Type Socket

Mechanism+Cover Plate 1M
WVTT1232-9



13A - 16A, 250V~
Screw Terminal, Child Protection



Euro-American Socket

Mech. + Cover Plate 1M Mech. + Cover Plate 1M
WVTT1225-9 WVTT1230-9



13A - 16A, 250V~
Screw Terminal



13A - 16A, 250V~
Screw Terminal, Child Protection



Socket 2P+E

Mech. + Cover Plate 2M Mech. + Cover Plate 2M
WVTT2212-9 WVTT2212-9RD

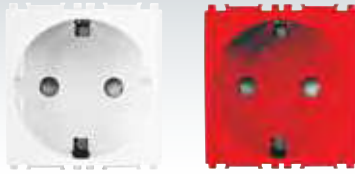

16A, 250V~
Screw Terminal, Child Protection



Socket 2P+E with Lid

Mechanism+Cover Plate 2M
WVTT2210-9



16A, 250V~
Screw Terminal, Child Protection



Socket 2P+E (French Standard)

Mechanism+Cover Plate 2M
WVTT2213-9



16A, 250V~
Screw Terminal, Child Protection



Socket 2P+E (British Type)

Mechanism+Cover Plate 2M
WVTT2226-9



6A - 10A - 13A, 250V~
Screw Terminal, Child Protection



Combi Socket

Mechanism+Cover Plate 2M
WVTT2224-9



6A - 10A - 13A, 250V~
Screw Terminal, Child Protection



USB Charger

Mechanism+Cover Plate 2M
WVTT2231-9



2A, 230V~
Screw Terminal



Shaver Socket •

Mechanism+Cover Plate 3M
WVTT3233-9



20VA, 110 / 230V~
Screw Terminal



Cover Plate Color Alternatives



WH

BG

Type of Terminals and Electrical Cables	Solid Wire	Stranded Wire	Flexible Wire
Screw Terminal	1.0-2.5mm ²	1.0-2.5mm ²	—
Screw Terminal	1.5-2.5mm ²	1.5-2.5mm ²	—

Data and Television Sockets

Phone Socket (CAT3)

Mechanism+Cover Plate 1M
WVTT1402-9



Data Socket (CAT5)

Mechanism+Cover Plate 1M
WVTT1404-9



Data Socket (CAT6)

Mechanism+Cover Plate 1M
WVTT1405-9



British Type Phone Jack

Mechanism+Cover Plate 1M
WVTT1418-9



USB Connector

Mechanism+Cover Plate 1M
WVTT1419-9



TV Socket, Terminated

Mechanism+Cover Plate 1M
WVTT1451-9



TV Socket, Through-pass

Mechanism+Cover Plate 1M
WVTT1453-9 (8 dB)
WVTT1452-9 (12 dB)



TV Socket, Lossless

Mechanism+Cover Plate 1M
WVTT1454-9



SAT Socket, Terminated

Mechanism+Cover Plate 1M
WVTT1458-9



SAT Socket, Through-pass (10 dB)

Mechanism+Cover Plate 1M
WVTT1459-9



Cover Plate Color Alternatives

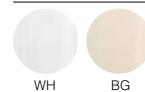

WH

BG

Data and Television Sockets

TV-SAT Socket, Terminated

Mechanism+Cover Plate 1M
WVTT1460-9



TV-SAT Socket, Terminated

Mechanism+Cover Plate 2M
WVTT2460-9



TV-SAT Socket, Through-pass

Mechanism+Cover Plate 2M
WVTT2462-9 (8 dB)
WVTT2461-9 (11 dB)



Multimedia Sockets

HDMI Connector

Mechanism+Cover Plate 1M
WVTT1470-9



VGA Connector

Mechanism+Cover Plate 1M
WVTT1471-9
WVTT1473-9 (with Terminal)



RCA Connector

Mechanism+Cover Plate 1M
WVTT1472-9



Volume Control Switch

Mechanism+Cover Plate 2M
WVTT2561-9
WVTT2564-9 (with Transformer)



Audio Channel Selection Switch

Mechanism+Cover Plate 2M
WVTT2563-9



Audio Socket

Mechanism+Cover Plate 1M
WVTT1560-9



Cover Plate Color Alternatives



Electronic Products

Analog Thermostat

Mechanism+Cover Plate 2M
WVTT2541-9



230V~



Motion Detector

Mechanism+Cover Plate 1M
WVTT1550-9



230V~, 1100W/VA



Buzzer (Ding-Dong) •

Mechanism+Cover Plate 1M
WVTT1704-9



230V~, 25mA



Hotel DND/MUR Switch •

Mechanism+Cover Plate 2M
WVTT2014-9



16AX, 250V~
Screw Terminal



Do not Disturb/Make-up Room Indicator •

Mechanism+Cover Plate 2M
WVTT2705-9NC



230V~, 2,5W Power Consumption

Cover Plate Color Alternatives



Direction Indicators

Orientation Lamp - White •

Mechanism+Cover Plate 2M
WVTT2724-9WH



230V~, 2.5W Power Consumption

Orientation Lamp - Red •

Mechanism+Cover Plate 2M
WVTT2724-9RD



230V~, 2.5W Power Consumption

Orientation Lamp - Green •

Mechanism+Cover Plate 2M
WVTT2724-9GR



230V~, 2.5W Power Consumption

Orientation Lamp - Blue •

Mechanism+Cover Plate 2M
WVTT2724-9BU



230V~, 2.5W Power Consumption

Direction Indicator - Arrow •

Mechanism+Cover Plate 2M
WVTC0707-9NC



230V~, 2.5W Power Consumption

Direction Indicator - Warning •

Mechanism+Cover Plate 2M
WVTC0709-9NC



230V~, 2.5W Power Consumption

Direction Indicator - Exit •

Mechanism+Cover Plate 2M
WVTC0710-9NC



230V~, 2.5W Power Consumption

Direction Indicator - Male/Female •

Mech. + Cover Plate 2M Mech. + Cover Plate 2M
WVTC0718-9NC (M) WVTC0719-9NC (F)

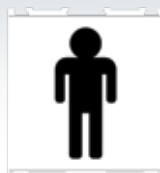

230V~, 2.5W Power Consumption

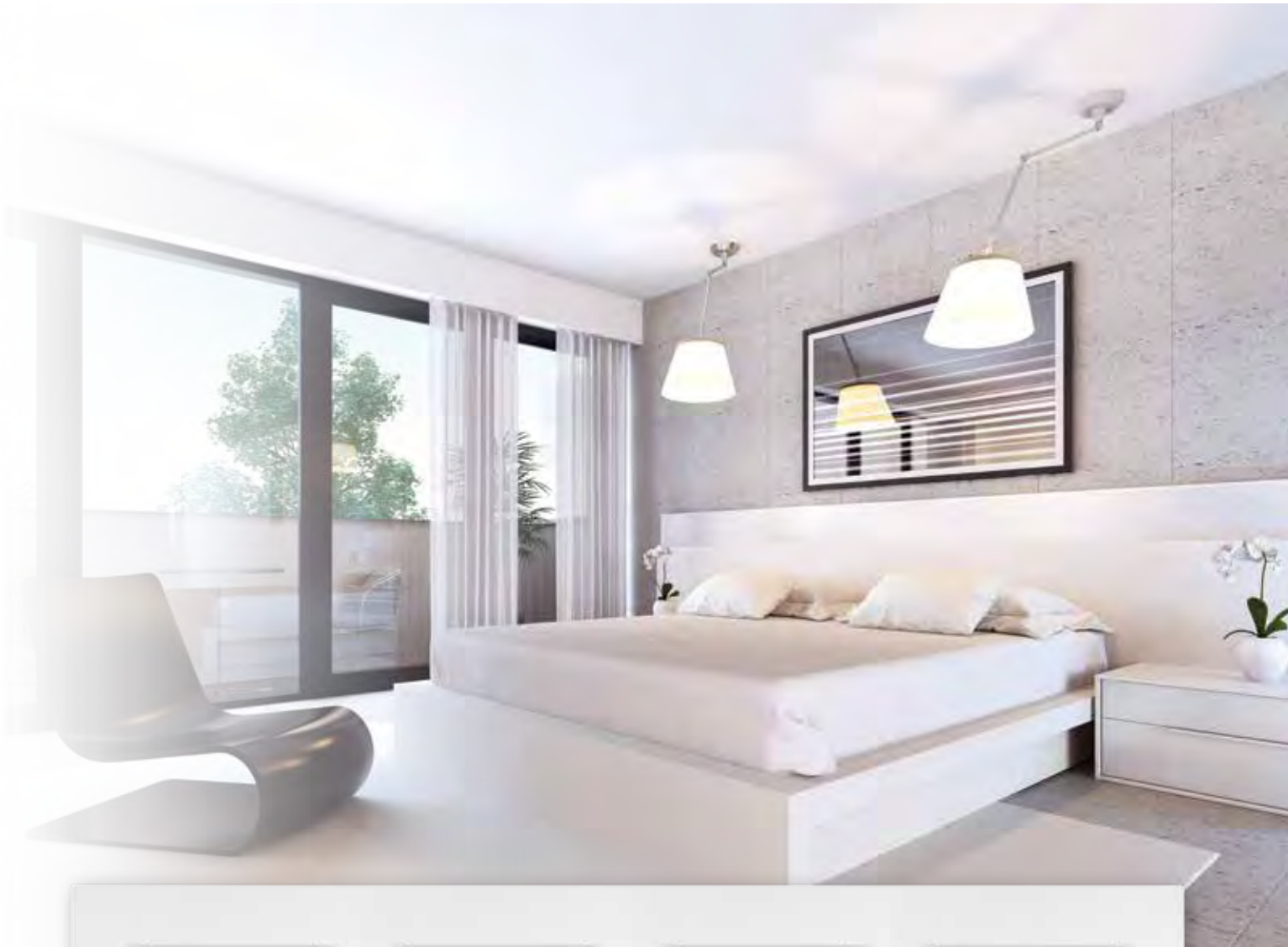

Switches (Mechanism and Rockers)

Switch

Mechanism WVTM1001-9NC	Rocker 1M WVTR1001-4 <input type="checkbox"/>	Rocker 2M WVTR2001-4 <input type="checkbox"/>
----------------------------------	---	---

16AX, 250V~
Screw Terminal

Switch, Illuminated

Mechanism WVTM1002-9NC (250V~) WVTM1042-9NC (Red Illum.) WVTM1047-9NC (24V)	Rocker 1M WVTR1002-4 <input type="checkbox"/>	Rocker 2M WVTR2002-4 <input type="checkbox"/>
---	---	---

16AX, 250V~
Screw Terminal

Two-way Switch

Mechanism WVTM1003-9NC	Rocker 1M WVTR1003-4 <input type="checkbox"/>	Rocker 2M WVTR2003-4 <input type="checkbox"/>
----------------------------------	---	---

16AX, 250V~
Screw Terminal

Two-way Switch, Illuminated

Mechanism WVTM1004-9NC (250V~) WVTM1049-9NC (24V)	Rocker 1M WVTR1004-4 <input type="checkbox"/>	Rocker 2M WVTR2004-4 <input type="checkbox"/>
--	---	---

16AX, 250V~
Screw Terminal

Intermediate Switch

Mechanism WVTM1005-9NC	Rocker 1M WVTR1005-4 <input type="checkbox"/>	Rocker 2M WVTR2005-4 <input type="checkbox"/>
----------------------------------	---	---

16AX, 250V~
Screw Terminal

Intermediate Switch, Illuminated

Mechanism WVTM1006-9NC	Rocker 1M WVTR1006-4 <input type="checkbox"/>	Rocker 2M WVTR2006-4 <input type="checkbox"/>
----------------------------------	---	---

16AX, 250V~
Screw Terminal

2-pole Switch

Mechanism WVTM1043-9NC	Rocker 1M WVTR1001-4 <input type="checkbox"/>	Rocker 2M WVTR2001-4 <input type="checkbox"/>
----------------------------------	---	---

16AX, 250V~
Screw Terminal

2-pole Switch, Illuminated

Mechanism WVTM1044-9NC	Rocker 1M WVTR1002-4 <input type="checkbox"/>	Rocker 2M WVTR2002-4 <input type="checkbox"/>
----------------------------------	---	---

16AX, 250V~
Screw Terminal

Rocker Color Alternatives



Type of Terminals and Electrical Cables	Solid Wire	Stranded Wire	Flexible Wire
Screw Terminal	1.0-2.5mm ²	1.0-2.5mm ²	—
Screw Terminal	1.5-2.5mm ²	1.5-2.5mm ²	—

Switches (Mechanism and Rockers)

One-way Push Button

Mechanism WVTM1016-9NC	Rocker 1M WVTR1016-4 <input type="checkbox"/>	Rocker 2M WVTR2016-4 <input type="checkbox"/>
----------------------------------	---	---



16A, 250V~
Screw Terminal



One-way Push Button, Illuminated

Mechanism WVTM1017-9NC (250V~) WVTM1048-9NC (24V)	Rocker 1M WVTR1017-4 <input type="checkbox"/>	Rocker 2M WVTR2017-4 <input type="checkbox"/>
--	---	---



16A, 250V~
Screw Terminal



Push Button with Bell Symbol

Mechanism WVTM1016-9NC	Rocker 1M WVTR1019-4 <input type="checkbox"/>	Rocker 2M WVTR2019-4 <input type="checkbox"/>
----------------------------------	---	---



16A, 250V~
Screw Terminal



Push Button with Bell Symbol, Illuminated

Mechanism WVTM1020-9NC	Rocker 1M WVTR1020-4 <input type="checkbox"/>	Rocker 2M WVTR2020-4 <input type="checkbox"/>
----------------------------------	---	---



16A, 250V~
Screw Terminal



Push Button with Key Symbol

Mechanism WVTM1016-9NC	Rocker 1M WVTR1018-4 <input type="checkbox"/>	Rocker 2M WVTR2018-4 <input type="checkbox"/>
----------------------------------	---	---



16A, 250V~
Screw Terminal



Push Button with Key Symbol, Illuminated

Mechanism WVTM1017-9NC	Rocker 1M WVTR1021-4 <input type="checkbox"/>	Rocker 2M WVTR2021-4 <input type="checkbox"/>
----------------------------------	---	---



16A, 250V~
Screw Terminal



Shutter Control Switch

Mechanism WVTM1023-9NC	Rocker 1M WVTR1023-4 <input type="checkbox"/>	Rocker 2M WVTR2023-4 <input type="checkbox"/>
----------------------------------	---	---



10AX, 250V~
Screw Terminal



Shutter Control Push Button

Mechanism WVTM1045-9NC	Rocker 1M WVTR1045-4 <input type="checkbox"/>	Rocker 2M WVTR2045-4 <input type="checkbox"/>
----------------------------------	---	---



10A, 250V~
Screw Terminal



Rocker Color Alternatives

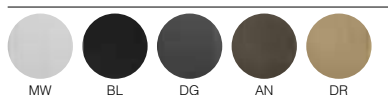



Type of Terminals and Electrical Cables	Solid Wire	Stranded Wire	Flexible Wire
 Screw Terminal	1.0-2.5mm ²	1.0-2.5mm ²	—
 Screw Terminal	1.5-2.5mm ²	1.5-2.5mm ²	—

Switches (Mechanism and Rockers)



Emergency Push Button with Cord
Mechanism+Rocker 1M
 WVTT1025-9





16A, 250V~
Screw Terminal

Double One-way Push Button
Mechanism WVTM1013-9NC
Rocker 1M WVTR1013-4

10A, 250V~
Screw Terminal

Blank Cover
Cover Plate 1M
 WVTR1701-4



Cable Outlet
Cover Plate 1M
 WVTR1702-4



Dimmers

PRO Dimmer R 6-100W •
Mechanism+Cover Plate 1M
 WVTT1520-9



230V~
Screw Terminal



PRO Dimmer R 20-300W
Mechanism+Cover Plate 1M
 WVTT1565-9



230V~
Screw Terminal





PRO Dimmer RC 20-300W 
Mechanism+Cover Plate 1M
 WVTT1521-9





230V~
Screw Terminal



Rotary Dimmer 1-10V •
Mechanism+Cover Plate 2M
 WVTT2527-9





230V~
Screw Terminal

Cover Plate/Rocker Color Alternatives



Type of Terminals and Electrical Cables	Solid Wire	Stranded Wire	Flexible Wire
 Screw Terminal	1.0-2.5mm ²	1.0-2.5mm ²	—
 Screw Terminal	1.5-2.5mm ²	1.5-2.5mm ²	—

Sockets (Mechanism and Rockers)

Socket 2P
Mechanism+Cover Plate 1M
 WVTT1211-9



16A, 250V~
Screw Terminal, Child Protection



Italian Type Socket
Mechanism+Cover Plate 1M
 WVTT1232-9



13A - 16A, 250V~
Screw Terminal, Child Protection





Euro-American Socket

Mech. + Cover Plate 1M
 WVTT1225-9





13A - 16A, 250V~
Screw Terminal

Mech. + Cover Plate 1M
 WVTT1230-9



13A - 16A, 250V~
Screw Terminal, Child Protection



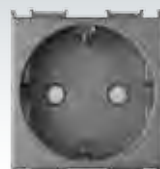

Socket 2P+E

Mech. + Cover Plate 2M
 WVTT2212-9



16A, 250V~
Screw Terminal, Child Protection

Mech. + Cover Plate 2M
 WVTT2212-9 RD



Socket 2P+E with Lid
Mechanism+Cover Plate 2M
 WVTT2210-9





16A, 250V~
Screw Terminal, Child Protection



Socket 2P+E (French Standard)
Mechanism+Cover Plate 2M
 WVTT2213-9



16A, 250V~
Screw Terminal, Child Protection

Socket 2P+E (British Type)
Mechanism+Cover Plate 2M
 WVTT2226-9



6A - 10A - 13A, 250V~
Screw Terminal, Child Protection



Combi Socket
Mechanism+Cover Plate 2M
 WVTT2224-9



6A - 10A - 13A, 250V~
Screw Terminal, Child Protection



USB Charger



Mechanism+Cover Plate 2M
 WVTT2231-9

2A, 230V~
Screw Terminal



Shaver Socket •
Mechanism+Cover Plate 3M
 WVTT3233-9





20VA, 110 / 230V~
Screw Terminal



Cover Plate Color Alternatives



Type of Terminals and Electrical Cables	Solid Wire	Stranded Wire	Flexible Wire
 Screw Terminal	1.0-2.5mm ²	1.0-2.5mm ²	—
 Screw Terminal	1.5-2.5mm ²	1.5-2.5mm ²	—

Data and Television Sockets

Phone Socket (CAT3)

Mechanism+Cover Plate 1M
WVTT1402-9



Data Socket (CAT5)

Mechanism+Cover Plate 1M
WVTT1404-9



Data Socket (CAT6)

Mechanism+Cover Plate 1M
WVTT1405-9



British Type Phone Jack

Mechanism+Cover Plate 1M
WVTT1418-9



USB Connector

Mechanism+Cover Plate 1M
WVTT1419-9



TV Socket, Terminated

Mechanism+Cover Plate 1M
WVTT1451-9



TV Socket, Through-pass

Mechanism+Cover Plate 1M
WVTT1453-9 (8dB)
WVTT1452-9 (12dB)



TV Socket, Lossless

Mechanism+Cover Plate 1M
WVTT1454-9



SAT Socket, Terminated

Mechanism+Cover Plate 1M
WVTT1458-9



SAT Socket, Through-pass (10 dB)

Mechanism+Cover Plate 1M
WVTT1459-9



Cover Plate Color Alternatives



Data and Television Sockets

TV-SAT Socket, Terminated

Mechanism+Cover Plate 1M
WVTT1460-9



TV-SAT Socket, Terminated

Mechanism+Cover Plate 2M
WVTT2460-9



TV-SAT Socket, Through-pass

Mechanism+Cover Plate 2M
WVTT2462-9 (8dB)
WVTT2461-9 (11dB)



Multimedia Sockets

HDMI Connector

Mechanism+Cover Plate 1M
WVTT1470-9



VGA Connector

Mechanism+Cover Plate 1M
WVTT1471-9
WVTT1473-9 (with Terminal)



RCA Connector

Mechanism+Cover Plate 1M
WVTT1472-9



Volume Control Switch

Mechanism+Cover Plate 2M
WVTT2561-9
WVTT2564-9 (with Transformer)



Audio Channel Selection Switch

Mechanism+Cover Plate 2M
WVTT2563-9



Audio Socket

Mechanism+Cover Plate 1M
WVTT1560-9



Cover Plate Color Alternatives

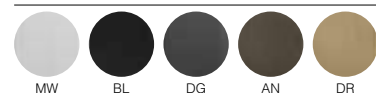

Electronic Products

Analog Thermostat

Mechanism+Cover Plate 2M
WVTT2541-9



230V~



Motion Detector

Mechanism+Cover Plate 1M
WVTT1550-9



230V~, 1100 W/WA



Buzzer (Ding-Dong)

Mechanism+Cover Plate 1M
WVTT1704-9



230V~, 25mA



Energy Saver Mechanic Switch 5V

Mechanism 2M
WVTM2577-9NC



5VDC, 150mA



Energy Saver Mechanic Switch 5V

Mechanism 3M
WVTM3577-9NC



5VDC, 150mA



Energy Saver Mechanic Switch 230V

Mechanism 2M
WVTM2576-9NC



230V~, 150mA



Energy Saver Mechanic Switch 230V

Mechanism 3M
WVTM3576-9NC



230V~, 150mA



Energy Saver 13,56 MHz RF

Mechanism 2M
WVTM2575-9NC



5VDC, 150mA



Energy Saver 13,56 MHz RF

Mechanism 3M
WVTM3575-9NC



5VDC, 150mA



Energy Saver Cover Plate

Cover Plate 2M
WVTR2721-4 (Optima) - (Sistema)
WVTR2578-4 (Ultima)



Available also in White and Beige colors.

Energy Saver Cover Plate

Cover Plate 3M
WVTR3721-4



Available also in White and Beige colors.

Cover Plate Color Alternatives



MW

BL

DG

AN

DR

Electronic Products

Hotel DND/MUR Switch •

Mechanism+Rocker 2M
WVTT2014-9



16AX, 250V~
Screw Terminal



Do not Disturb/Make-up Room Indicator •

Mechanism+Cover Plate 2M
WVTT2705-9NC



230V~, 2,5W Power Consumption

Direction Indicators

Orientation Lamp - White •

Mechanism+Cover Plate 2M
WVTT2724-9WH



230V~, 2,5W Power Consumption

Orientation Lamp - Red •

Mechanism+Cover Plate 2M
WVTT2724-9RD



230V~, 2,5W Power Consumption

Orientation Lamp - Green •

Mechanism+Cover Plate 2M
WVTT2724-9GR



230V~, 2,5W Power Consumption

Orientation Lamp - Blue •

Mechanism+Cover Plate 2M
WVTT2724-9BU



230V~, 2,5W Power Consumption

Direction Indicator - Arrow •

Mechanism+Cover Plate 2M
WVTC0707-9NC



230V~, 2,5W Power Consumption

Direction Indicator - Warning •

Mechanism+Cover Plate 2M
WVTC0709-9NC



230V~, 2,5W Power Consumption

Direction Indicator - Exit •

Mechanism+Cover Plate 2M
WVTC0710-9NC



230V~, 2,5W Power Consumption

Direction Indicator - Male/Female •

Mech. + Cover Plate 2M Mech. + Cover Plate 2M
WVTC0718-9NC (M) WVTC0719-9NC (F)



230V~, 2,5W Power Consumption

Cover Plate Color Alternatives

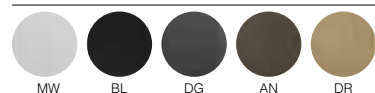

Mechanism/Rocker/Frame Alternatives

Mechanism Cover Plate/Rocker Frame Complete





ultima







WVTF2843-5

sistema





WVTF1843-5



optima









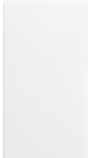

WVTF0843-1

Cover Plate/Rocker Color Alternatives



						
white WH	beige BG	metallic white MW	black BL	dark gray DG	hard coal AN	dore DR

Frame Color Alternatives

Metallic



inox **MI** chrome **MC** gold **MG** una **MU**

Glass



white **GW** light green **GG** claret red **GC** black **GB**

Eloxal



silver **AS** bronze **AR** black **AB**

Wooden



bamboo **WB** venge **WV** walnut **WW**

Metallic



inox
Inox+Dark Gray **IG**
Inox-Metallic Dark Gray **IN**

inox matt
Inox Matt-Dore **IM**
Inox Matt+Metallic White **IB**

chrome
Chrome+Dark Gray **KF**
Chrome- Metallic White **CH**

chrome matt
Chrome Matt+ Dark Gray **KD**
Chrome Matt-Metallic White **CM**



una
Una-Dark Gray **UN**
Una+Metallic White **UW**

antique
Antique-Dore **AQ**
Antique+Black **AY**

gold
Gold-Dore **GL**
Gold+Black **GS**

Opaque



white **WH** beige **BG**

Metallik



white **MW** black **BL** dark gray **DG** hard coal **AN** dore **DR**

Ultima Frames

Frames

2M Frame
WVTF2840-5 □□



2x2M Frame
WVTF2848-5 □□



3M Frame
WVTF2843-5 □□



3x2M Frame
WVTF2849-5 □□



4M Frame
WVTF2844-5 □□



4x2M Frame
WVTF2850-5 □□



7M Frame
WVTF2847-5 □□



Frame Codes

Frame Colors	2M Frame	3M Frame	4M Frame	7M Frame
Wooden - American Walnut	WVTF2840-5WW	WVTF2843-5WW	WVTF2844-5WW	WVTF2847-5WW
Wooden - Bamboo	WVTF2840-5WB	WVTF2843-5WB	WVTF2844-5WB	WVTF2847-5WB
Wooden - Wenge	WVTF2840-5WV	WVTF2843-5WV	WVTF2844-5WV	WVTF2847-5WV
Aluminium - Bronze	WVTF2840-5AR	WVTF2843-5AR	WVTF2844-5AR	WVTF2847-5AR
Aluminium - Silver	WVTF2840-5AS	WVTF2843-5AS	WVTF2844-5AS	WVTF2847-5AS
Aluminium - Black	WVTF2840-5AB	WVTF2843-5AB	WVTF2844-5AB	WVTF2847-5AB
Glass - White	WVTF2840-5GW	WVTF2843-5GW	WVTF2844-5GW	WVTF2847-5GW
Glass - Claret Red	WVTF2840-5GC	WVTF2843-5GC	WVTF2844-5GC	WVTF2847-5GC
Glass - Black	WVTF2840-5GB	WVTF2843-5GB	WVTF2844-5GB	WVTF2847-5GB
Glass - Light Green	WVTF2840-5GG	WVTF2843-5GG	WVTF2844-5GG	WVTF2847-5GG
Metallic Chrome	WVTF2840-5MC	WVTF2843-5MC	WVTF2844-5MC	WVTF2847-5MC
Metallic Gold	WVTF2840-5MG	WVTF2843-5MG	WVTF2844-5MG	WVTF2847-5MG
Metallic Inox	WVTF2840-5MI	WVTF2843-5MI	WVTF2844-5MI	WVTF2847-5MI
Metallic Una	WVTF2840-5MU	WVTF2843-5MU	WVTF2844-5MU	WVTF2847-5MU

Frame Colors	2X2M Frame	3X2M Frame	4X2M Frame
Wooden - American Walnut	WVTF2848-5WW	WVTF2849-5WW	WVTF2850-5WW
Wooden - Bamboo	WVTF2848-5WB	WVTF2849-5WB	WVTF2850-5WB
Wooden - Wenge	WVTF2848-5WV	WVTF2849-5WV	WVTF2850-5WV
Aluminium - Bronze	WVTF2848-5AR	WVTF2849-5AR	WVTF2850-5AR
Aluminium - Silver	WVTF2848-5AS	WVTF2849-5AS	WVTF2850-5AS
Aluminium - Black	WVTF2848-5AB	WVTF2849-5AB	WVTF2850-5AB
Glass - White	WVTF2848-5GW	WVTF2849-5GW	WVTF2850-5GW
Glass - Claret Red	WVTF2848-5GC	WVTF2849-5GC	WVTF2850-5GC
Glass - Black	WVTF2848-5GB	WVTF2849-5GB	WVTF2850-5GB
Glass - Light Green	WVTF2848-5GG	WVTF2849-5GG	WVTF2850-5GG
Metallic Chrome	WVTF2848-5MC	WVTF2849-5MC	WVTF2850-5MC
Metallic Gold	WVTF2848-5MG	WVTF2849-5MG	WVTF2850-5MG
Metallic Inox	WVTF2848-5MI	WVTF2849-5MI	WVTF2850-5MI
Metallic Una	WVTF2848-5MU	WVTF2849-5MU	WVTF2850-5MU

Sistema Frames

Frames

2M Frame
WVTF1840-5 □□



2x2M Frame
WVTF1848-5 □□



3M Frame
WVTF1843-5 □□



3x2M Frame
WVTF1849-5 □□



4M Frame
WVTF1844-5 □□



4x2M Frame
WVTF1850-5 □□



7M Frame
WVTF1847-5 □□



Frame Codes

Frame Colors	2M Frame	3M Frame	4M Frame	7M Frame
Antique - Dore	WVTF1840-5AQ	WVTF1843-5AQ	WVTF1844-5AQ	WVTF1847-5AQ
Antique - Black	WVTF1840-5AY	WVTF1843-5AY	WVTF1844-5AY	WVTF1847-5AY
Chrome - Dark Gray	WVTF1840-5KF	WVTF1843-5KF	WVTF1844-5KF	WVTF1847-5KF
Chrome - Metallic White	WVTF1840-5CH	WVTF1843-5CH	WVTF1844-5CH	WVTF1847-5CH
Chrome Matt - Dark Gray	WVTF1840-5KD	WVTF1843-5KD	WVTF1844-5KD	WVTF1847-5KD
Chrome Matt - Metallic White	WVTF1840-5CM	WVTF1843-5CM	WVTF1844-5CM	WVTF1847-5CM
Gold - Dore	WVTF1840-5GL	WVTF1843-5GL	WVTF1844-5GL	WVTF1847-5GL
Gold - Black	WVTF1840-5GS	WVTF1843-5GS	WVTF1844-5GS	WVTF1847-5GS
Inox - Dark Gray	WVTF1840-5IG	WVTF1843-5IG	WVTF1844-5IG	WVTF1847-5IG
Inox - Metallic White	WVTF1840-5IN	WVTF1843-5IN	WVTF1844-5IN	WVTF1847-5IN
Inox Matt - Dore	WVTF1840-5IM	WVTF1843-5IM	WVTF1844-5IM	WVTF1847-5IM
Inox Matt - Metallic White	WVTF1840-5IB	WVTF1843-5IB	WVTF1844-5IB	WVTF1847-5IB
Una - Dark Gray	WVTF1840-5UN	WVTF1843-5UN	WVTF1844-5UN	WVTF1847-5UN
Una - Metallic White	WVTF1840-5UW	WVTF1843-5UW	WVTF1844-5UW	WVTF1847-5UW

Frame Colors	2X2M Frame	3X2M Frame	4X2M Frame
Wooden - American Walnut	WVTF1848-5AQ	WVTF1849-5AQ	WVTF1850-5AQ
Wooden - Bamboo	WVTF1848-5AY	WVTF1849-5AY	WVTF1850-5AY
Wooden - Venge	WVTF1848-5KF	WVTF1849-5KF	WVTF1850-5KF
Aluminium - Bronze	WVTF1848-5CH	WVTF1849-5CH	WVTF1850-5CH
Aluminium - Silver	WVTF1848-5KD	WVTF1849-5KD	WVTF1850-5KD
Aluminium - Black	WVTF1848-5CM	WVTF1849-5CM	WVTF1850-5CM
Glass - White	WVTF1848-5GL	WVTF1849-5GL	WVTF1850-5GL
Glass - Claret Red	WVTF1848-5GS	WVTF1849-5GS	WVTF1850-5GS
Glass - Black	WVTF1848-5IG	WVTF1849-5IG	WVTF1850-5IG
Glass - Light Green	WVTF1848-5IN	WVTF1849-5IN	WVTF1850-5IN
Metallic Chrome	WVTF1848-5IM	WVTF1849-5IM	WVTF1850-5IM
Metallic Gold	WVTF1848-5IB	WVTF1849-5IB	WVTF1850-5IB
Metallic Inox	WVTF1848-5UN	WVTF1849-5UN	WVTF1850-5UN
Metallic Una	WVTF1848-5UW	WVTF1849-5UW	WVTF1850-5UW

Optima Frames

Frames

2M Frame
WVTF0840-1 □□



3M Frame - 1 Module
WVTF0841-1 □□



3M Frame
WVTF0843-1 □□



3M Frame - 2 Modules
WVTF0842-1 □□



4M Frame
WVTF0844-1 □□



7M Frame
WVTF0847-1 □□



2x2M Frame
WVTF0848-1 □□



3x2M Frame
WVTF0849-1 □□



4x2M Frame
WVTF0850-1 □□



IP55 Frame 3M
WVTF0860-1 WH/BG 



Frame Codes

Frame Colors	2M Frame	3M Frame	1/3M Frame	2/3M Frame
Hard Coal	WVTF0840-1AN	WVTF0843-1AN	WVTF0841-1AN	WVTF0842-1AN
Dore	WVTF0840-1DR	WVTF0843-1DR	WVTF0841-1DR	WVTF0842-1DR
Dark Gray	WVTF0840-1DG	WVTF0843-1DG	WVTF0841-1DG	WVTF0842-1DG
Beige	WVTF0840-1BG	WVTF0843-1BG	WVTF0841-1BG	WVTF0842-1BG
Metallic White	WVTF0840-1MW	WVTF0843-1MW	WVTF0841-1MW	WVTF0842-1MW
Opaque White	WVTF0840-1WH	WVTF0843-1WH	WVTF0841-1WH	WVTF0842-1WH
Black	WVTF0840-1BL	WVTF0843-1BL	WVTF0841-1BL	WVTF0842-1BL

Frame Colors	4M Frame	7M Frame	2X2M Frame	3X2M Frame
Hard Coal	WVTF0844-1AN	WVTF0847-1AN	WVTF0848-1AN	WVTF0849-1AN
Dore	WVTF0844-1DR	WVTF0847-1DR	WVTF0848-1DR	WVTF0849-1DR
Dark Gray	WVTF0844-1DG	WVTF0847-1DG	WVTF0848-1DG	WVTF0849-1DG
Beige	WVTF0844-1BG	WVTF0847-1BG	WVTF0848-1BG	WVTF0849-1BG
Metallic White	WVTF0844-1MW	WVTF0847-1MW	WVTF0848-1MW	WVTF0849-1MW
Opaque White	WVTF0844-1WH	WVTF0847-1WH	WVTF0848-1WH	WVTF0849-1WH
Black	WVTF0844-1BL	WVTF0847-1BL	WVTF0848-1BL	WVTF0849-1BL

Frame Colors	4X2M Frame
Hard Coal	WVTF0850-1AN
Dore	WVTF0850-1DR
Dark Gray	WVTF0850-1DG
Beige	WVTF0850-1BG
Metallic White	WVTF0850-1MW
Opaque White	WVTF0850-1WH
Black	WVTF0850-1BL

Mounting Frames



WVTC0730-4NC MOUNTING FRAME 2M
WVTC0731-4NC MOUNTING 2M-HOLLOW WALL



WVTC0732-4NC MOUNTING FRAME 2M-METAL



WVTC0733-4NC MOUNTING FRAME 2/3M
WVTC0737-4NC MOUNTING FRAME 2/3M WITH CLAW



WVTC0734-4NC MOUNTING FRAME 3M

Wall Mount Boxes



WVTC0784-4NC
2M WALL MOUNT BOX H.F. - HOLLOW WALL



WVTC0785-4NC
3M WALL MOUNT BOX H.F. - HOLLOW WALL



WVTC0780-4NC
2M WALL MOUNT BOX H.F.



WVTC0781-4NC
3M WALL MOUNT BOX H.F.



WVTC0735-4NC MOUNTING FRAME 4M



WVTC0736-4NC MOUNTING FRAME 7M



WVTC0786-4NC
4M WALL MOUNT BOX H.F. - HOLLOW WALL



WVTC0787-4NC
7M WALL MOUNT BOX H.F. - HOLLOW WALL



WVTC0782-4NC
4M WALL MOUNT BOX H.F.



WVTC0783-4NC
7M WALL MOUNT BOX H.F.

Assembling for Wall Box

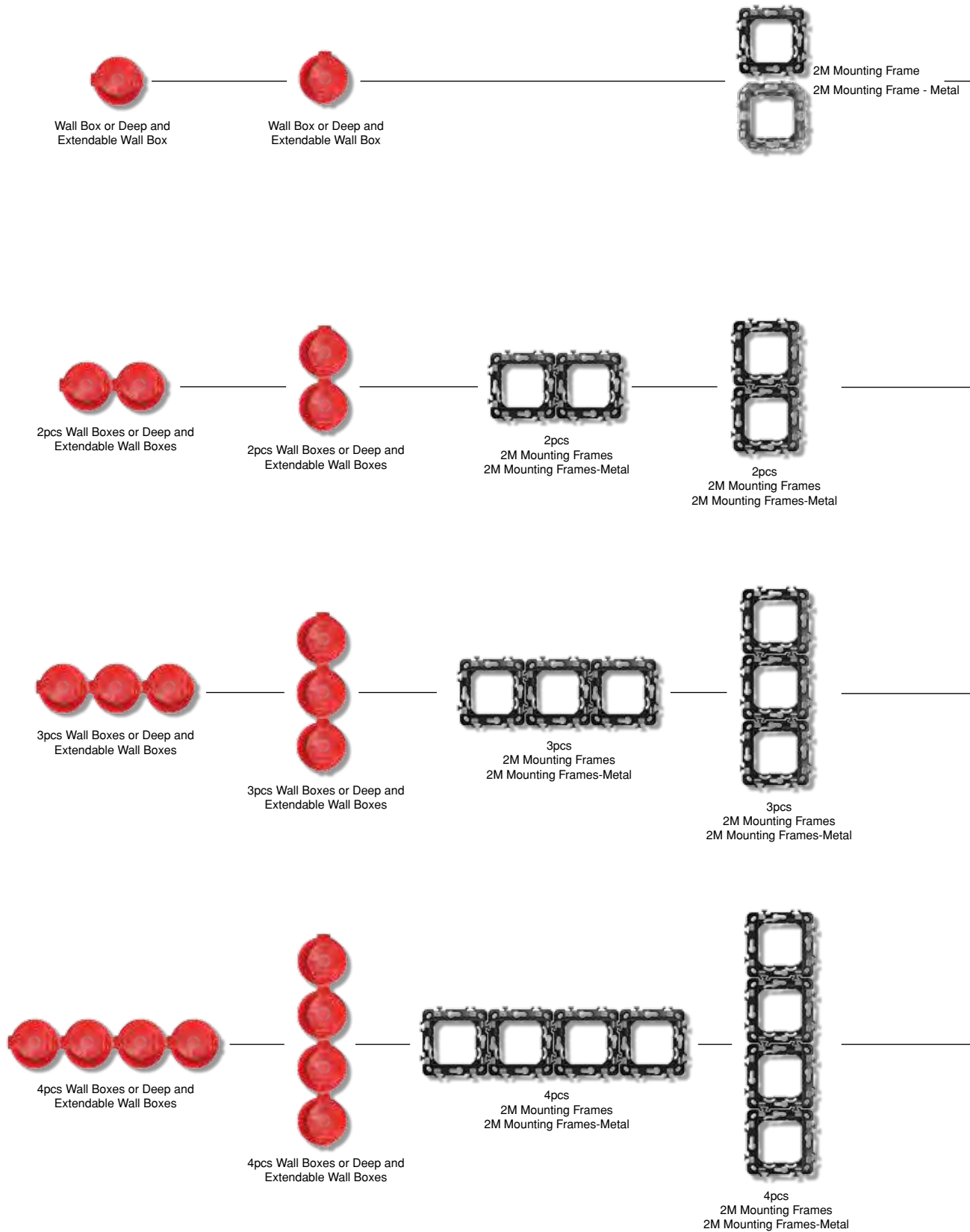

Order Codes and Product Name

WVTC0730-4NC	Mounting Frame 2M	WVTC0737-4NC	Mounting Frame 2/3M with Claw
WVTC0731-4NC	Mounting Frame 2M- Hollow wall	WVTC0734-4NC	Mounting Frame 3M
WVTC0732-4NC	Mounting Frame 2M-Metal	WVTC0735-4NC	Mounting Frame 4M
WVTC0733-4NC	Mounting Frame 2/3M	WVTC0736-4NC	Mounting Frame 7M



2X1M Switch



2M Frame



2M



4X1M Switch



2X2M Frame(2-Gang Frame)



2X2M Horizontal Frame



4X1M Switch



2X2M Frame (2-Gang Frame)



2X2M Vertical Frame (2-Gang Frame)



6X1M Switch



3X2M Frame (3-Gang Frame)



3X2M Horizontal Frame



6X1M Switch



3X2M Frame (3-Gang Frame)



3X2M Vertical Frame (3-Gang Frame)



8X1M Switch



4X2M Frame(4-Gang Frame)



4X2M Horizontal Frame



8X1M Switch



4X2M Frame (4-Gang Frame)



4X2M Vertical Frame (4-Gang Frame)

Assembling for Hollow Wall Mounting Box



2M Wall Mount Box H.F. - Hollow Wall



2M Mounting Frame
2M Mounting Frame-Metal
2M Mounting Frame-Hollow wall



3M Wall Mount Box H.F. - Hollow Wall



2/3M Mounting Frame



3M Wall Mount Box H.F. - Hollow Wall



3M Mounting Frame



4M Wall Mount Box H.F. - Hollow Wall



4M Mounting Frame



7M Wall Mount Box H.F. - Hollow Wall



7M Mounting Frame

Order Codes and Product Name

WVTC0784-4NC	2M Wall Mount Box H.F.- Hollow Wall
WVTC0785-4NC	3M Wall Mount Box H.F.- Hollow Wall
WVTC0786-4NC	4M Wall Mount Box H.F.- Hollow Wall
WVTC0787-4NC	7M Wall Mount Box H.F.- Hollow Wall



2X1M Switch



2M Frame



2M



2X1M Switch



2/3M Frame



2/3M



1M Switch



1/3M Frame



1/3M



3X1M Switch



3M Frame



3M



4X1M Switch



4M Frame



4M



7X1M Switch



7M Frame



7M

Assembling for Modular Box



2M Wall Mount Box H.F.



2M Mounting Frame
2M Mounting Frame-Metal
2M Mounting Frame-Hollow wall



3M Wall Mount Box H.F.



2/3M Mounting Frame



3M Wall Mount Box H.F.



3M Mounting Frame



4M Wall Mount Box H.F.



4M Mounting Frame



7M Wall Mount Box H.F.



7M Mounting Frame

Order Codes and Product Name

WVTC0780-4NC	2M Wall Mount Box H.F.
WVTC0781-4NC	3M Wall Mount Box H.F.
WVTC0782-4NC	4M Wall Mount Box H.F.
WVTC0783-4NC	7M Wall Mount Box H.F.



2X1M Switch



2M Frame



2M



2X1M Switch



2/3M Frame



2/3M



1M Switch



1/3M Frame



1/3M



3X1M Switch



3M Frame



3M



4X1M Switch



4M Frame



4M



7X1M Switch



7M Frame



7M

technical specifications

62 - 71	Technical Specifications and Circuit Diagrams
72	Ultima Frame Dimensions
73	Sistema Frame Dimensions
74	Optima Frame Dimensions
75	Wall Box Dimensions
76	Mounting Frame Dimensions

Technical Drawings and Circuit Diagrams



Technical Specifications

Switch

Circuit Diagram

- Controls a lamp or a lamp group from a point.
- 16AX, 250V~
- One-way
- Screw connection

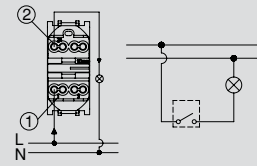
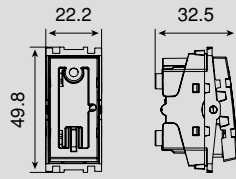

Technical Specifications

One-Way Switch, Illuminated

Circuit Diagram

- Controls a lamp or a lamp group from a point.
- 16AX, 250V~
- One-way
- Illuminated indicator
- Screw connection

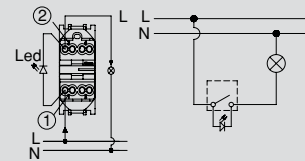
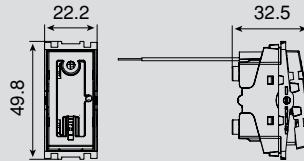

Technical Specifications

Two-Way Switch

Circuit Diagram

- Controls a lamp or a lamp group from two different points.
- 16AX, 250V~
- Two-way
- Screw connection

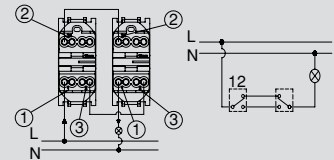
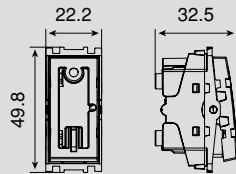

Technical Specifications

Two-Way Switch, Illuminated

Circuit Diagram

- Controls a lamp or a lamp group from two different points.
- 16AX, 250V~
- Two-way
- Illuminated indicator
- Screw connection

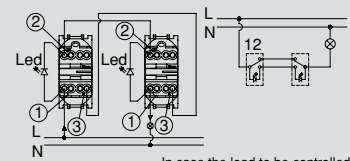
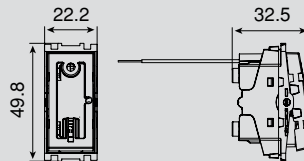

In case the load to be controlled by the product is a load generating in-rush like LED lamp and CFL lamp, please read the warnings part.



Technical Specifications

Intermediate Switch

Circuit Diagram

- Controls a lamp or a lamp group from more than two points.
- 16AX, 250V~
- Two-way
- Screw connection

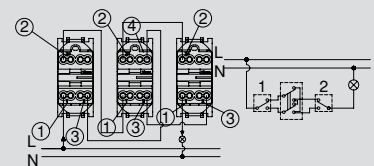
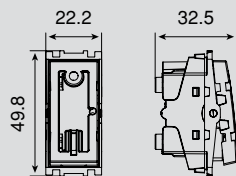

Technical Specifications

Intermediate Switch, Illuminated

Circuit Diagram

- Controls a lamp or lamp group from more than two points.
- 16AX, 250V~
- Two-way
- Illuminated indicator
- Screw connection

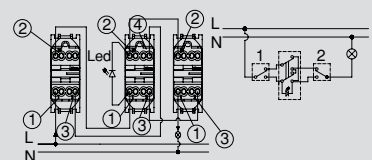
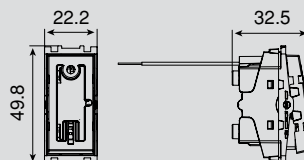

Technical Specifications







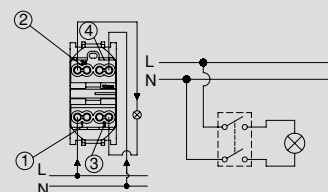
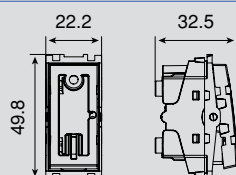



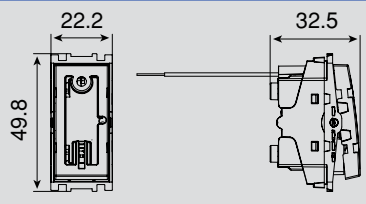
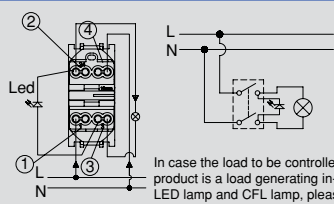

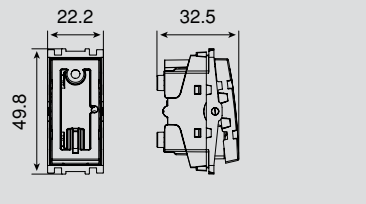
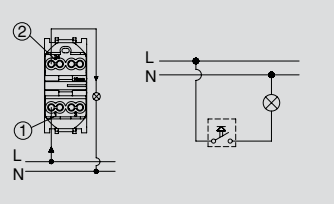
Two-Pole Switch

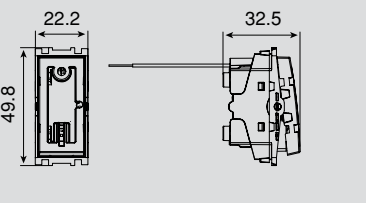
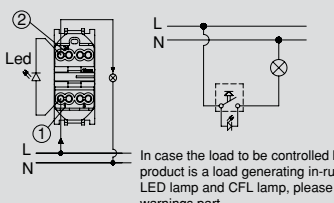
Circuit Diagram

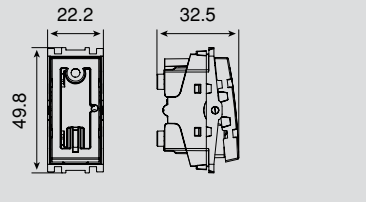
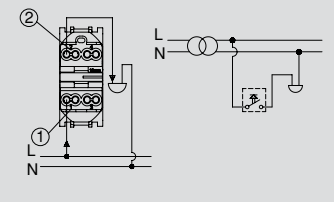
- Two poles enable simultaneous disconnection of switches, phase and neutral.
- 16AX, 250V~
- Double pole, one-way
- Screw connection

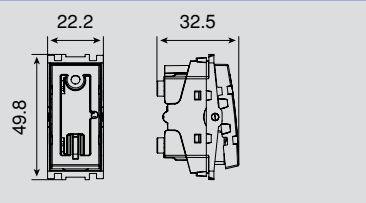
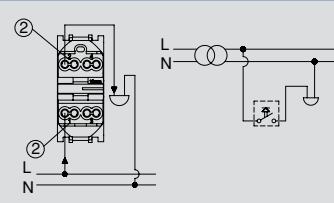

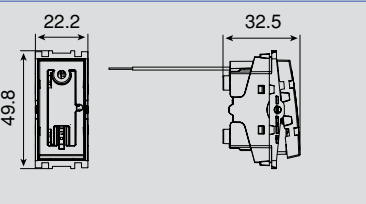
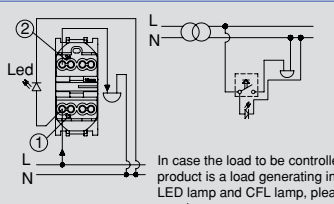
Technical Drawings and Circuit Diagrams

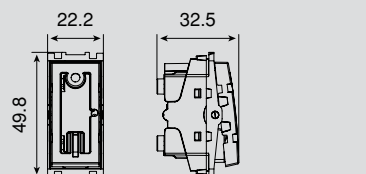
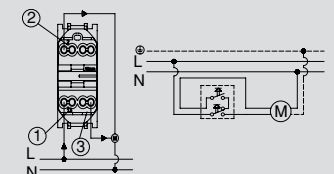
	Technical Specifications	Two-Pole Switch, Illuminated	Circuit Diagram
	<ul style="list-style-type: none"> • Two poles enable simultaneous disconnection of switches, phase and neutral. • 16AX, 250V~ • Double pole, single way • Illuminated indicator • Screw connection 		 <p>In case the load to be controlled by the product is a load generating in-rush like LED lamp and CFL lamp, please read the warnings part.</p>
	Technical Specifications	One-Way Push Button	Circuit Diagram
	<ul style="list-style-type: none"> • Generates control signals for external trigger circuits such as building lights with automatic timer, motion detector or automated system. • 16A, 250V~ • One-way • Push button, instant trigger • Screw connection 		
	Technical Specifications	One-Way Push Button, Illuminated	Circuit Diagram
	<ul style="list-style-type: none"> • Generates control signals for external trigger circuits such as building lights with automatic timer, motion detector or automated system. • 16A, 250V~ • One-way • Push button, instant trigger • Illuminated indicator • Screw connection 		 <p>In case the load to be controlled by the product is a load generating in-rush like LED lamp and CFL lamp, please read the warnings part.</p>
	Technical Specifications	Push Button with Key Symbol	Circuit Diagram
	<ul style="list-style-type: none"> • Generates control signals for external trigger circuits such as building lights with automatic timer, motion detector or automated system. • 10A, 250V~ • One-way • Push button, instant trigger • Screw connection 		
	Technical Specifications	Push Button with Bell Symbol	Circuit Diagram
	<ul style="list-style-type: none"> • Controls the door bell. • 10A, 250V~ • One-way • Push button, instant trigger • Screw connection 		
	Technical Specifications	Push Button with Bell Symbol, Illuminated	Circuit Diagram
	<ul style="list-style-type: none"> • Controls the door bell. • 10A, 250V~ • Push button, instant trigger • Illuminated indicator • Screw connection 		 <p>In case the load to be controlled by the product is a load generating in-rush like LED lamp and CFL lamp, please read the warnings part.</p>
	Technical Specifications	Shutter Control Switch	Circuit Diagram
	<ul style="list-style-type: none"> • Controls up and down movement of shutters, by controlling shutter motors via single button • 10AX, 250V~ • Two way, three positions • Screw connection 		

Technical Drawings and Circuit Diagrams



Technical Specifications

Emergency Push Button with Cord

Circuit Diagram

- Generates control signals for external trigger circuits such as building lights with automatic timer, motion detector or automated system.
- 10AX, 250V~
- One-way
- Push button, instant trigger
- Screw connection

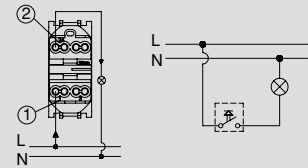
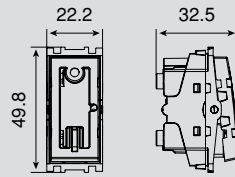

Technical Specifications

Double One-way Push Button

Circuit Diagram

- Generates two different control signals for external trigger circuits such as motion detectors or automated systems.
- Two independent phase inputs allow connection of multiple different phases.
- 10AX, 250V~
- Double pole, single way
- Screw connection

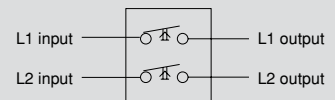
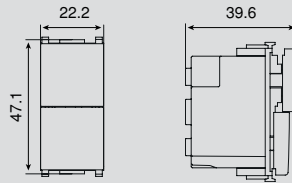

Technical Specifications

Pro Dimmer R 300W 1M

Circuit Diagram

- R type dimmer
- 300W maximum output power (R type load)
- 20W minimum output power
- Feature to use as two-way
- Feature to switch on/off at the set level of dimming.

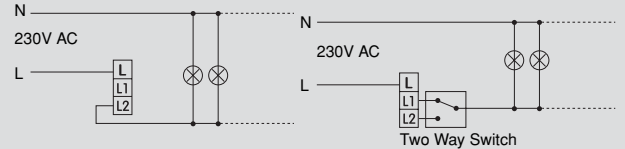
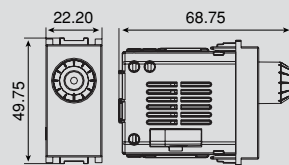

Technical Specifications

Pro Dimmer R 6-100W/VA

Circuit Diagram

- R type dimmer
- 100W maximum output power (R type load)
- 6W minimum output power
- Feature to use as two-way
- Feature to switch on/off at the set level of dimming.

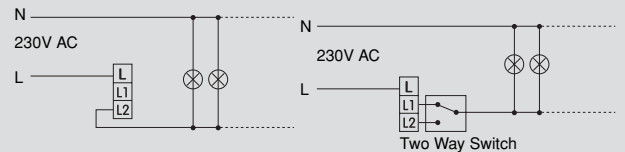
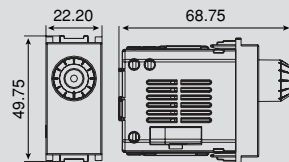

Technical Specifications

Pro Dimmer RC 20-300W/VA

Circuit Diagram

- RC type dimmer
- 300W maximum output power (R type load) 300VA maximum output power 300VA (C type load)
- 20W minimum output power
- Feature to use as two-way
- Feature to switch on/off at the set level of dimming.

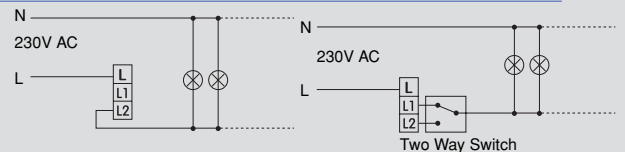
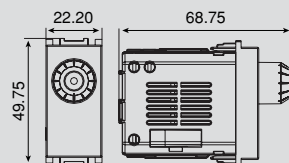

Technical Specifications







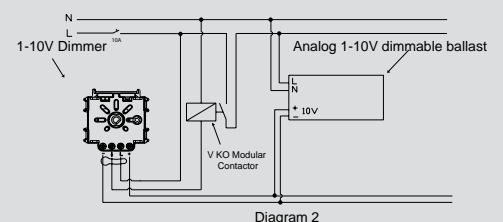
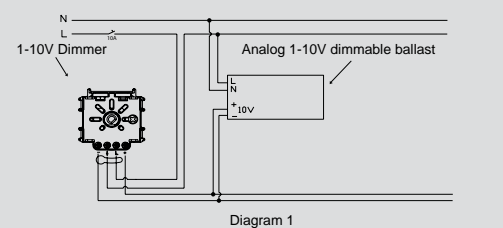
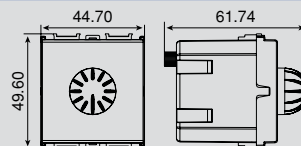



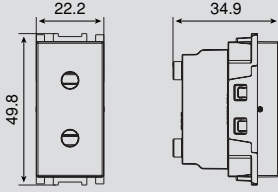
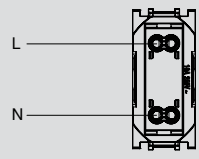

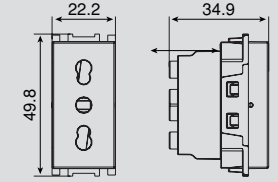
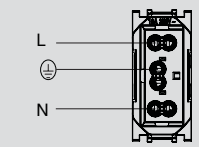
Rotary Dimmer 1-10V

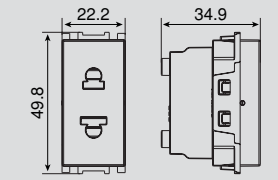
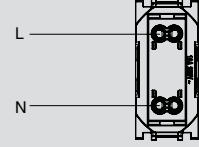
Circuit Diagram

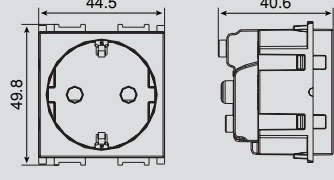
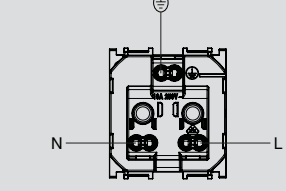

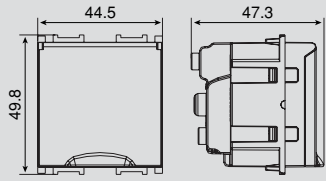
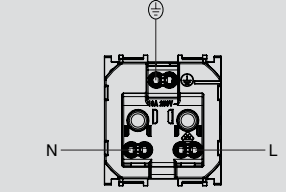

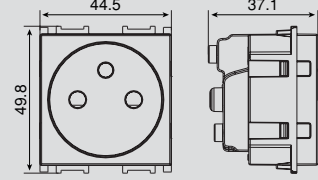
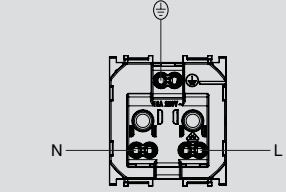

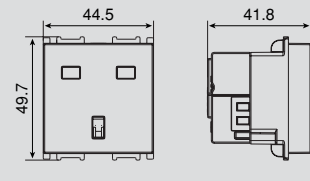
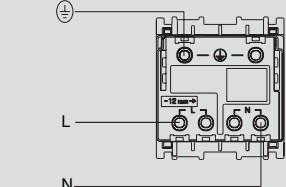

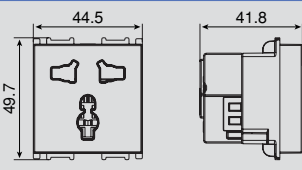
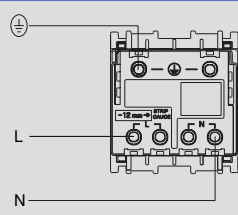

- Operating temperature +5°C...+35°C
- 0,8V...11V control voltage
- Control current 50mA
- Switching current 5AX
- Fuse 500mAh

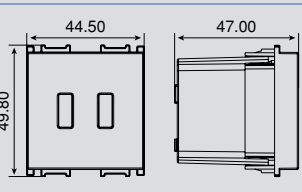
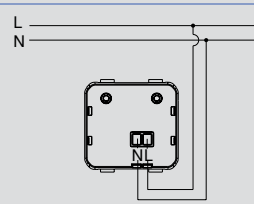

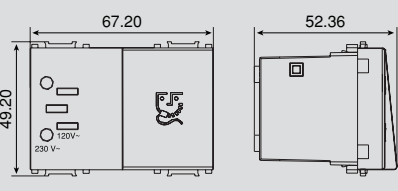
Technical Drawings and Circuit Diagrams

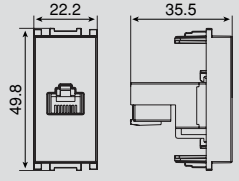
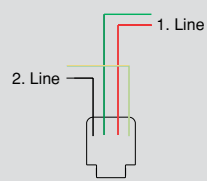
	Technical Specifications	Socket 2P, Child Protection	Circuit Diagram
	<ul style="list-style-type: none"> • 16A, 250V~ • 2P • Child protection • Screw connection 		
	Technical Specifications	Italian Type Socket	Circuit Diagram
	<ul style="list-style-type: none"> • 13A-16A • 2P+E • Child protection • Screw connection 		
	Technical Specifications	Euro-American Socket	Circuit Diagram
	<ul style="list-style-type: none"> • 13A-16A • 2P • Child protection option • Screw connection 		
	Technical Specifications	Socket 2P+E, Child Protection	Circuit Diagram
	<ul style="list-style-type: none"> • 16A, 250V~ • 2P+E • Child protection • Screw connection 		
	Technical Specifications	Socket 2P+E with Lid, Child Protection	Circuit Diagram
	<ul style="list-style-type: none"> • 16A, 250V~ • 2P+E • Child protection • Screw connection 		
	Technical Specifications	Socket 2P+E French Type, Child Protection	Circuit Diagram
	<ul style="list-style-type: none"> • 16A, 250V~ • 2P+E • Child protection • Screw connection 		
	Technical Specifications	Socket 2P+E British Type, Child Protection	Circuit Diagram
	<ul style="list-style-type: none"> • 6A-10A-13A • 2P+E • Child protection • Screw connection 		

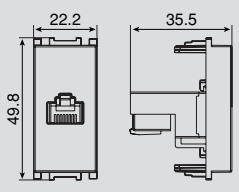
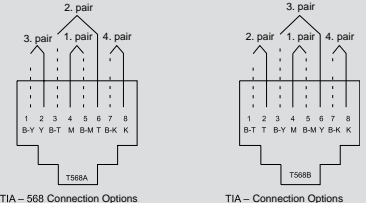
Technical Drawings and Circuit Diagrams

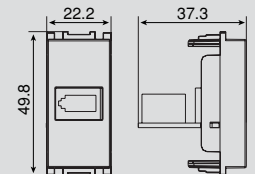
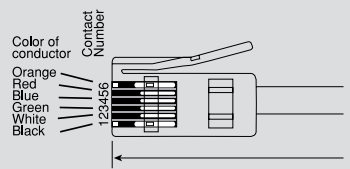
	Technical Specifications	Combi Socket	Circuit Diagram
	<ul style="list-style-type: none"> • 6A-10A-13A • 2P+E • Child protection • Screw connection 		
	Technical Specifications	USB Socket	Circuit Diagram
	<ul style="list-style-type: none"> • 1A, 250V~ • 5VDC output voltage • Operating temperature +10°C...+55°C • Child protection • Screw connection 		
	Technical Specifications	Shaver Socket	Circuit Diagram
	<ul style="list-style-type: none"> • 230V~, 50/60Hz • 230V~/ 120V~ output voltage • 20VA maximum load • IP21 protection class 		
	Technical Specifications	Phone Socket (RJ11)	Circuit Diagram
	<ul style="list-style-type: none"> • Connector structure complying with RJ11 standard has four contacts. • Two telephone lines can be connected. • Green and red wires are used for the 1st line, and yellow and black wires for the 2nd line. 		
	Technical Specifications	Data Socket (RJ45)	Circuit Diagram
	<ul style="list-style-type: none"> • RJ45 connector complying with standards EIA/TIA 568 A and B • Pins on it have been marked according to both 568 A and 568 B standards. 		 <p>TIA - 568 Connection Options TIA - Connection Options</p>
	Technical Specifications	British Type Phone Socket	Circuit Diagram
	<ul style="list-style-type: none"> • Pins on it have been marked according to both 431A and 631A standards. 		 <p>Color of conductor Orange Red Blue Green White Black</p> <p>Contact Number 123456</p>

Technical Drawings and Circuit Diagrams



Technical Specifications

USB Connector

Circuit Diagram

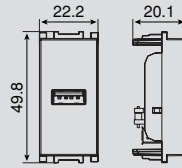

Technical Specifications

TV Socket

Circuit Diagram

Shielded. Shielded, does not get affected by airborne radio signals.

- Screw type mounting.

TV Socket, Through-pass

Used for broadcast distribution to multiple TV receivers where broadcast is received from UHF/VHF bands to the center via an antenna system and then distributed via inter-socket or inter-floor -in multi-storey buildings- transition.

TV Socket, Terminated

Used in star-connected systems for Internet, cable TV or central satellite broadcasts. May also be used at the end of the shared antenna systems.

TV Socket, Lossless

Used with independent Internet, cable TV or satellite broadcasting systems, and independent antennas.

- The sockets to be mounted after the amplifier must be 12 dB and 8 dB through-pass, terminated and lossless options to be compatible with 60-85 dBuV TV signal levels.

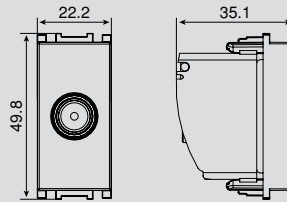

TV Socket (Through-pass)				
Frequency range (f/MHz)	5 MHz	860 MHz	950 MHz	1000 MHz
IN-OUT (DB)	3,5	3,5	3,5	3,5

TV Socket (Terminated)				
Frequency range (f/MHz)	5 MHz	860 MHz	950 MHz	1000 MHz
IN-OUT (DB)	1,6	1,7	1,8	2,0
IN-TAP (DB)	15	15	15	15,5

TV Socket (Lossless)				
Frequency range (f/MHz)	5 MHz	860 MHz	950 MHz	1000 MHz
IN-TAP (DB)	3,5 dB	3,5 dB	3,5 dB	3,5 dB
IN-OUT (DB)	3,5 dB	5 dB	5 dB	5 dB



Technical Specifications

Satellite Socket with F Connector

Circuit Diagram

Used for receiving broadcast from the cable TV and UHF/VHF bands, and satellite.

Satellite Socket with F Connector, Through-pass

Used for broadcast distribution to multiple TV receivers where broadcast is received from UHF/VHF bands to the center via an antenna system and then distributed via inter-socket or inter-floor -in multi-storey buildings- transition.

Satellite Socket with F Connector, Terminated

Used in star-connected systems for Internet, cable TV or central satellite broadcasts. May also be used at the end of the shared antenna systems.

- The sockets to be mounted after the amplifier must be (10dB) transitive and terminated options to be compatible with 60-85 dBuV TV signal levels.

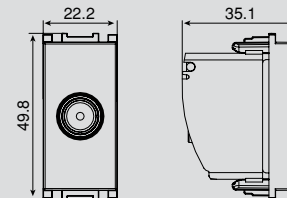

TV - SAT (Through-pass)									
Frequency range (f/MHz)	5 MHz	860 MHz	950 MHz	1000 MHz	1,2 GHz	1,6 GHz	2,0 GHz	2,25 GHz	2,4 GHz
SAT IN-OUT (DB)	≤ 11,5	≤ 11,5	≤ 11,5	≤ 12	≤ 12,5	≤ 14	≤ 14	≤ 14	≤ 14,5
TV IN-OUT (DB)	≤ 3,5	≤ 3,5	≤ 3,5	≤ 3,5					

SAT (Terminated)									
Frequency range (f/MHz)	5 MHz	860 MHz	950 MHz	1000 MHz	1,2 GHz	1,6 GHz	2,0 GHz	2,25 GHz	2,4 GHz
SAT IN-OUT (DB)	≤ 3,5	≤ 3,5	≤ 3,5	≤ 3,5	≤ 3,5	≤ 3,5	≤ 3,5	≤ 3,5	≤ 3,5



Technical Specifications

TV-SAT Socket

Circuit Diagram

- Shielded. Shielded, does not get affected by airborne radio signals.

- Used for receiving broadcast from the Internet, interactive applications, cable TV, and UHF/VHF bands.

TV-SAT Socket, Through-pass

Used for broadcast distribution to multiple TV receivers where broadcast is received from UHF/VHF bands to the center via an antenna system and then distributed via inter-socket or inter-floor -in multi-storey buildings- transition.

TV-SAT Socket, Terminated

Used in star-connected systems for Internet, cable TV or central satellite broadcasts. May also be used at the end of the shared antenna systems.

- The sockets to be mounted after the amplifier must be (8dB and 11dB) transitive and terminated options to be compatible with 60-85 dBuV TV signal levels.

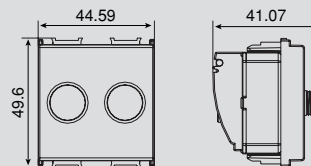

TV - SAT (Through-pass)									
Frequency range (f/MHz)	5 MHz	860 MHz	950 MHz	1000 MHz	1,2 GHz	1,6 GHz	2,0 GHz	2,25 GHz	2,4 GHz
SAT IN-OUT (DB)	≤ 3,5	≤ 3,5	≤ 3,5	≤ 3,5	≤ 3,5	≤ 3,5	≤ 3,5	≤ 3,5	≤ 3,5
TV IN-OUT (DB)	≤ 3,5	≤ 3,5	≤ 3,5	≤ 3,5					

TV - SAT (Terminated)									
Frequency range (f/MHz)	5 MHz	860 MHz	950 MHz	1000 MHz	1,2 GHz	1,6 GHz	2,0 GHz	2,25 GHz	2,4 GHz
SAT IN-OUT (DB)	≤ 11,5	≤ 11,5	≤ 11,5	≤ 12	≤ 12,5	≤ 14	≤ 14	≤ 14	≤ 14,5
SAT IN-TAP (DB)	≤ 2,5	≤ 2,5	≤ 2,5	≤ 2,5	≤ 3	≤ 3,8	≤ 4,5	≤ 5	≤ 5,5
TV IN-OUT (DB)	≤ 1,6	≤ 1,7	≤ 1,8	≤ 2,0					
TV IN-TAP (DB)	≤ 15	≤ 15	≤ 15	≤ 15,5					

Technical Drawings and Circuit Diagrams



Technical Specifications

HDMI Connector

Circuit Diagram

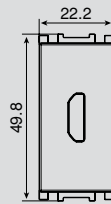

Technical Specifications

VGA Connector

Circuit Diagram

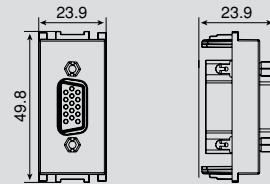

Technical Specifications

VGA Connector (PCB)

Circuit Diagram

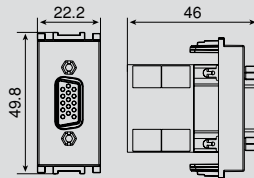

Technical Specifications

RCA Connector

Circuit Diagram

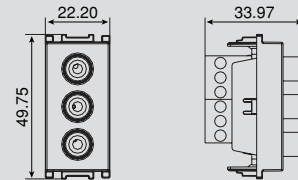

Technical Specifications

Volume Control Switch with Transformer

Circuit Diagram

- 11-grade sound adjustment
- 2VA transformer
- Suitable for systems with line transformer
- 4x100W speakers with line transformer
- Suitable for deep cases
- Built-in relay unit for 100V sound systems and emergency announcements.

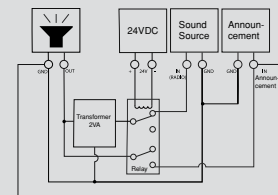
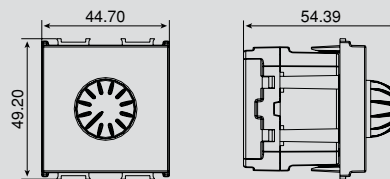

Technical Specifications

Audio Channel Selection Switch

Circuit Diagram

- 5 channel selection

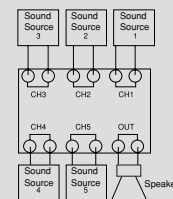
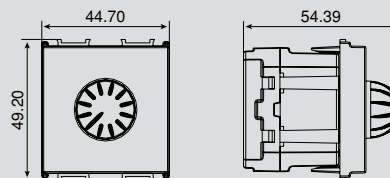

Technical Specifications

Audio Socket

Circuit Diagram

- 11-grade sound adjustment
- 3-1200 Ω
- Suitable for shallow cases
- 5W speaker input
- 8Ω resistant volume control

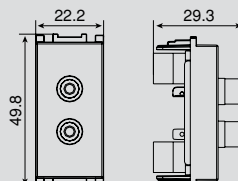

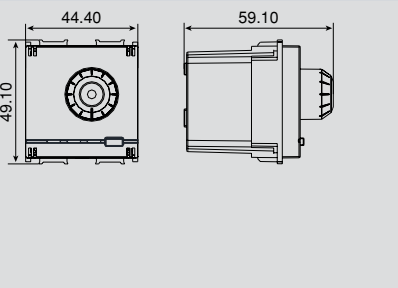
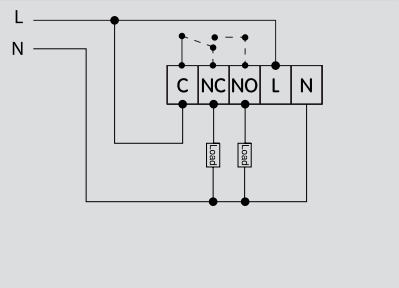

Technical Drawings and Circuit Diagrams

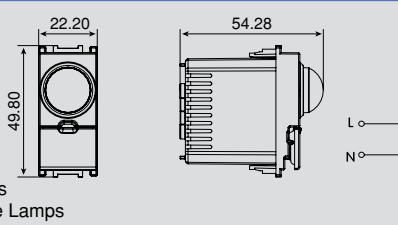
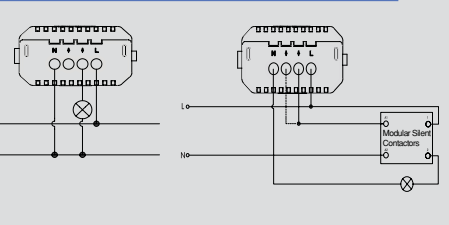
	Technical Specifications	Analog Thermostat	Circuit Diagram
	<ul style="list-style-type: none"> • 230V~, 50/60Hz • Maximum output current: * Changeover/normally open contact NO: 10(4)A 230VAC * Changeover/normally closed contact NC: 5(2)A 230VAC • Temperature control range of $\pm 1^{\circ}\text{C}$ between $+10^{\circ}\text{C}$...$+30^{\circ}\text{C}$ • Shortest switching time 5 minutes • Operating temperature 0°C...$+30^{\circ}\text{C}$ • Complies with standards EN 60730-1 and EN 60730-2-9 		

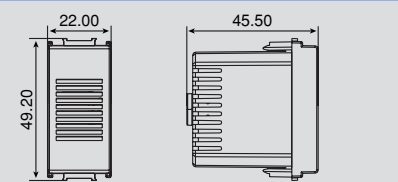
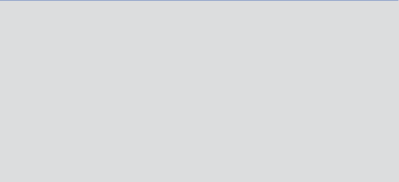
	Technical Specifications	Motion Detector	Circuit Diagram
	<ul style="list-style-type: none"> • 230V~, 50/60Hz • 180° horizontal sensing angle • Time setting from 10 seconds to 20 minutes • Operating temperature 0°C...$+35^{\circ}\text{C}$ • Assembly height between 1m and 2m • Suitable for usage with loads at the range of 50W/VA - 300W/VA • Daylight setting between 5 lux - 250 lux values • Not for use with LED, Fluorescent or CFL type Lamps 		

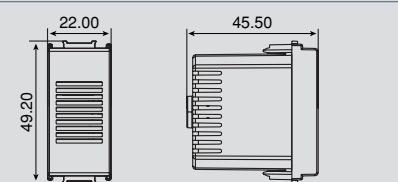
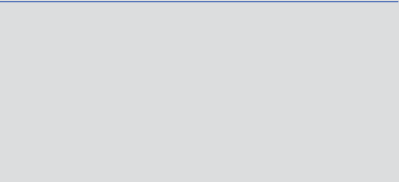
	Technical Specifications	Buzzer (Ding-Dong)	Circuit Diagram
	<ul style="list-style-type: none"> • 230V~, 50/60Hz • 85dB minimum sound volume 		

	Technical Specifications	Buzzer	Circuit Diagram
	<ul style="list-style-type: none"> • 230V~, 50/60Hz • 85dB minimum sound volume 		

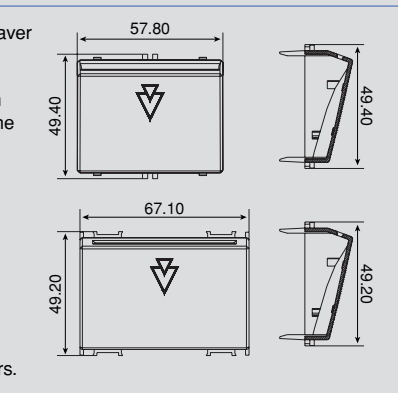
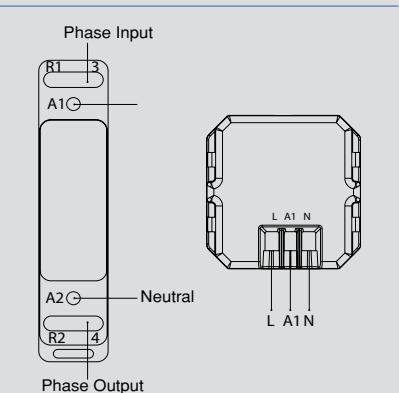
	Technical Specifications	Energy Saver Mechanical Switch 230V	Circuit Diagram
	<ul style="list-style-type: none"> • When a proper card is inserted into Energy Saver reader slot, it sends energy to relay coils to activate the electricity in the room. • When the card is removed from the slot, room electricity is cut within 15 ± 3 seconds. When the card is inserted into its slot, pilot lighting LED goes off. • 250V~ operating voltage • 0.5A maximum switching current • Minimum diameter of connection cable is $0,50\text{mm}^2$, maximum length is 25m • 15 ± 3 seconds shutting down delay • Complies with standard EN60669-2-1 • Suitable for usage with all card types • The product Energy Saver Mechanical Switch 220V can only be used with suitable contactors. 		

Technical Drawings and Circuit Diagrams



Technical Specifications

Energy Saver Mechanical Switch 5V

Circuit Diagram

- When a proper card is inserted into Energy Saver reader slot, it sends signal to relay unit to activate the electricity in the room.
- When the card is removed from the slot, room electricity is cut within 15 ± 3 seconds. Delay is made by relay unit. When the card is inserted into its slot, pilot lighting LED goes off (if LED is still on, it means that the card isn't sensed).
- 5V operating voltage
- 16A maximum switching current
- Minimum diameter of connection cable is $0,50\text{mm}^2$, maximum length is 25m
- 15 ± 3 seconds shutting down delay
- Complies with standard EN60669-2-1
- Suitable for usage with all card types
- The product Energy Saver Mechanical Switch 5V is suitable for usage with ESCU type relay.
- Connection cables between energy saver card reader and relay unit should be spanned within a different channel away from indoor 230V installation cables and cables with shielding feature should be used.

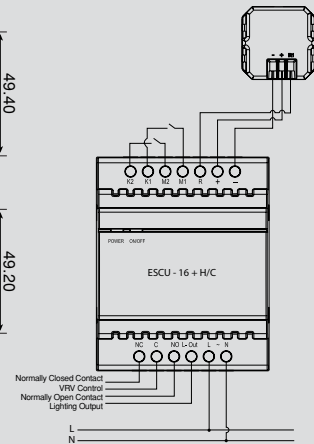
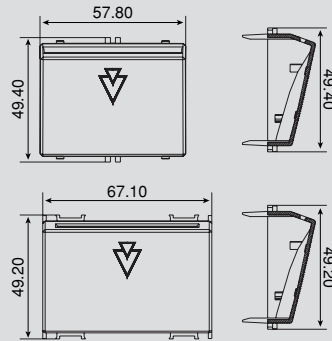

Technical Specifications

Energy Saver 13,56 MHz RF

Circuit Diagram

- When a proper card is inserted into Energy Saver reader slot, it sends signal to relay unit to activate the electricity in the room.
- When the card is removed from the slot, room electricity is cut within 15 seconds. Delay is made by relay unit. When the card is inserted into its slot, pilot lighting LED goes off (if LED is still on, it means that the card isn't sensed).
- 5V operating voltage
- 16A maximum switching current
- Minimum diameter of connection cable is $0,50\text{mm}^2$, maximum length is 25m
- 15 ± 3 seconds shutting down delay
- Complies with standard EN60669-2-1
- Suitable for usage with cards complying with standard ISO/IEC 14443A
- The product Energy Saver 13,56 MHz RF is suitable for usage with ESCU type relay.
- Connection cables between Energy Saver card reader and relay unit should be spanned within a different channel away from indoor 230V installation cables and cables with shielding feature should be used.

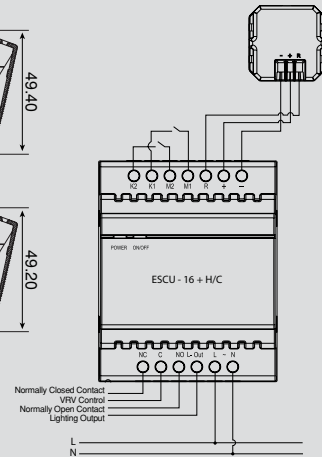
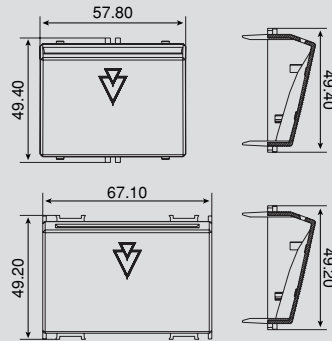

Technical Specifications

Do not Disturb/Make-up Room Indicator

Circuit Diagram

- 230V~
- 2,5W power consumption

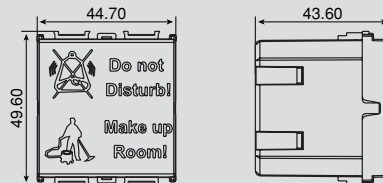

Technical Specifications

Direction Indicator - Arrow

Circuit Diagram

- 230V~
- 2,5W power consumption

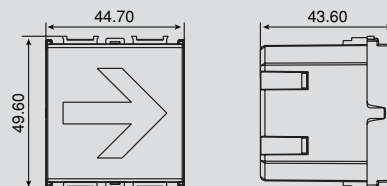

Technical Drawings and Circuit Diagrams

Technical Specifications

- 230V~
- 2,5W power consumption

Direction Indicator - Warning

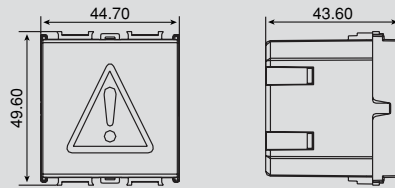

Circuit Diagram

Technical Specifications

- 230V~
- 2,5W power consumption

Direction Indicator - Exit

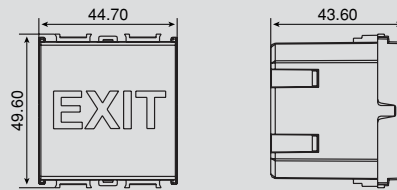

Circuit Diagram

Technical Specifications

- 230V~
- 2,5W power consumption

Direction Indicator - Male/Female

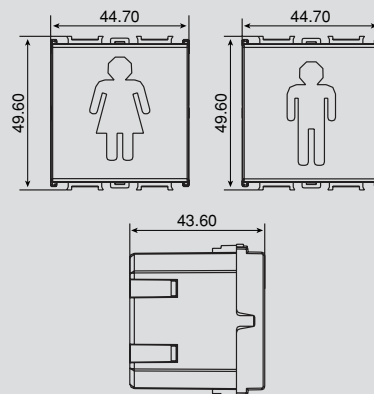

Circuit Diagram

Frame Dimensions

Ultima 2M Frame

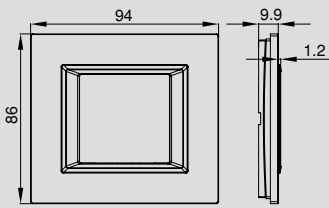

Ultima 2x2M Frame

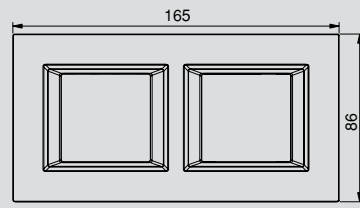

Ultima 3M Frame

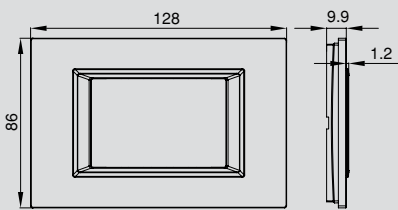

Ultima 3x2M Frame

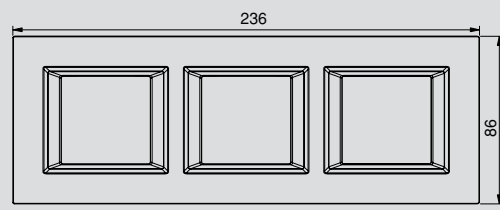

Ultima 4M Frame

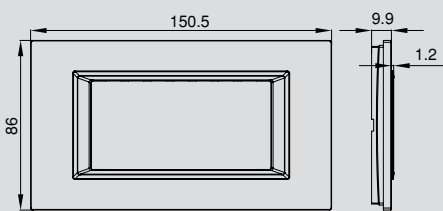

Ultima 4x2M Frame

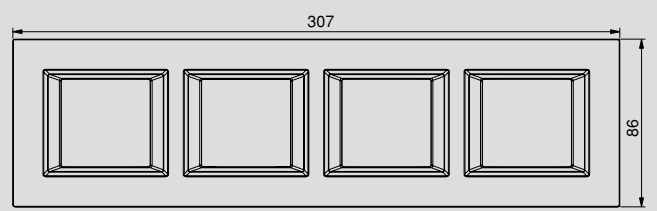

Ultima 7M Frame

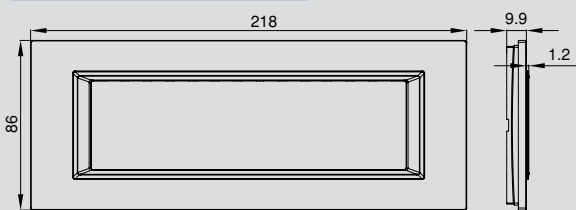

Frame Dimensions

Sistema 2M Frame

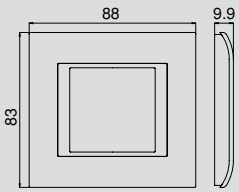

Sistema 2x2M Frame

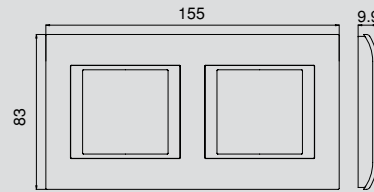

Sistema 3M Frame

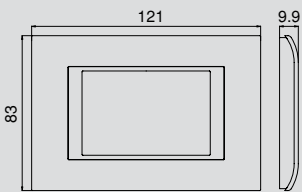

Sistema 3x2M Frame

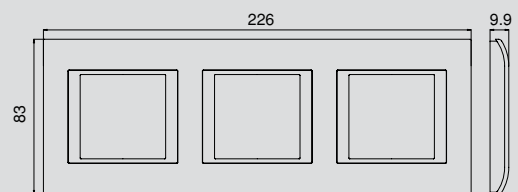

Sistema 4M Frame

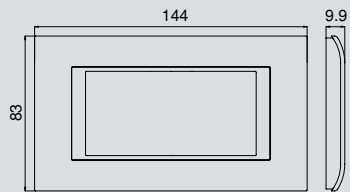

Sistema 4x2M Frame

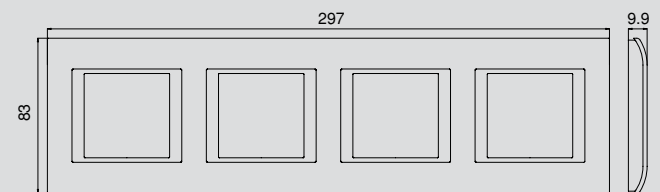

Sistema 7M Frame

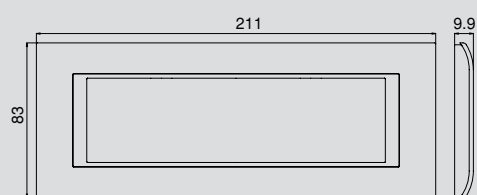

Frame Dimensions

Optima 2M Frame

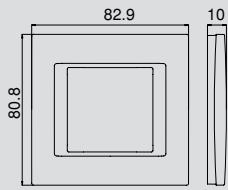

Optima 2x2M Frame

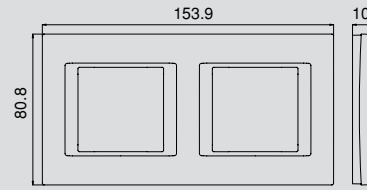

Optima 3M Frame

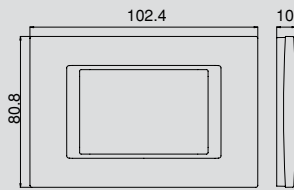

Optima 3x2M Frame

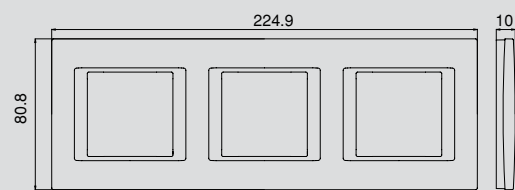

Optima 4M Frame

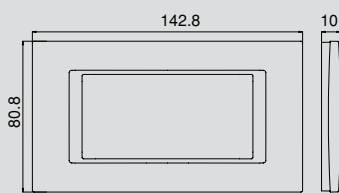

Optima 4x2M Frame

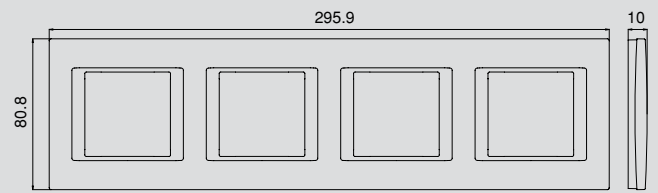

Optima 7M Frame

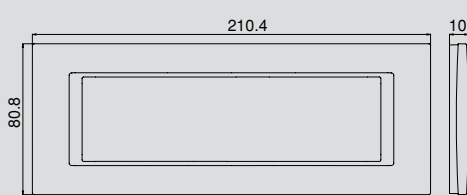

IP55 Frame

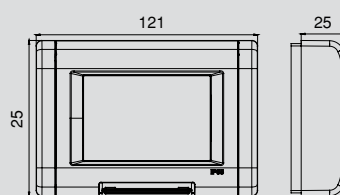

Wall Box Dimensions

Hallow Wall Box 2M

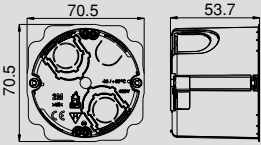

Wall Mount Box 2M

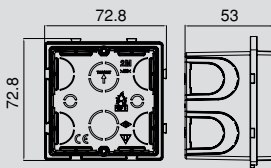

Hallow Wall Box 3M

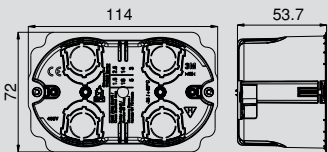

Wall Mount Box 3M

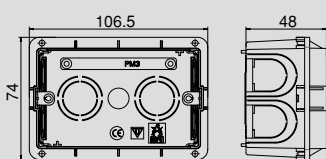

Hallow Wall Box 4M

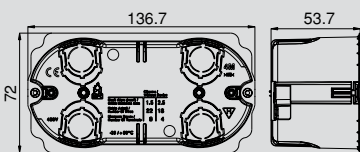

Wall Mount Box 4M

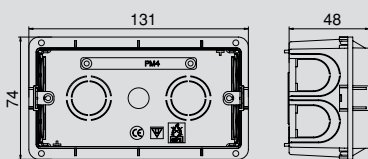

Hallow Wall Box 7M

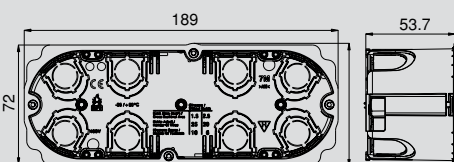

Wall Mount Box 7M

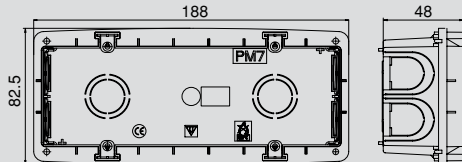

Mounting Frame Dimensions

Mounting Frame 2M

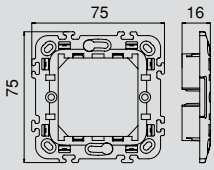

Metal Mounting Frame 2M

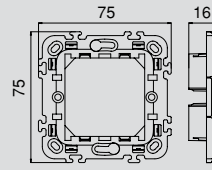

Mounting Frame 3M

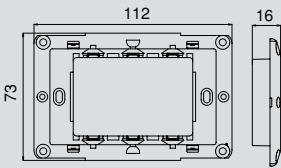

Mounting Frame 4M

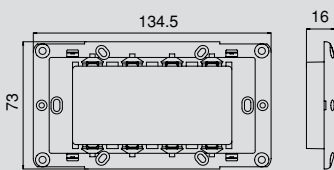

Mounting Frame 7M

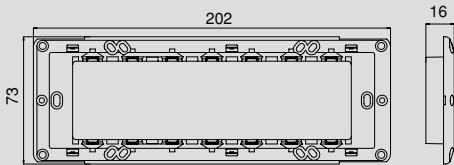

New pop-up solutions for mobile devices

COMING
SOON

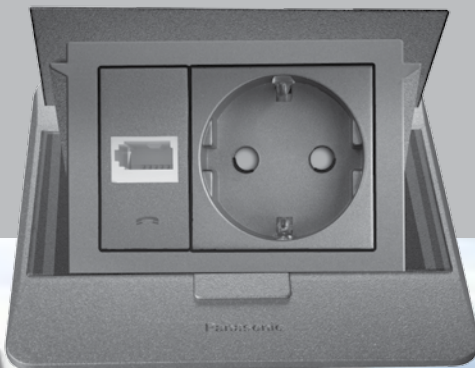
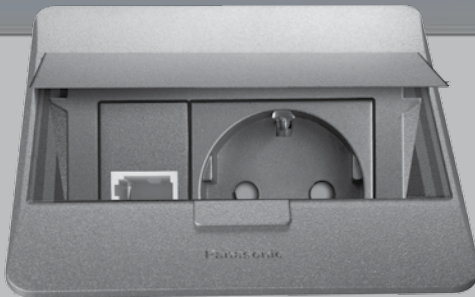
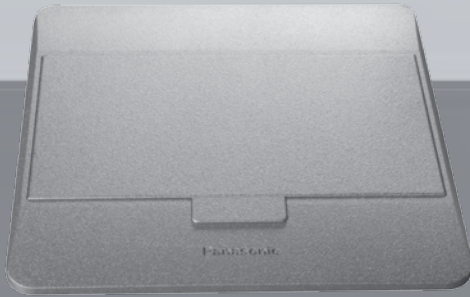

Meet new pop-up solutions offering the most advanced Panasonic technology developed for use on table and floors. New pop-up products in connection of your laptops, mobile phones, tablet pc, small house appliances, professional hand tools or other mobile devices make the reliable usage, speed and convenience you seek a part of your life in office, hotel or shopping malls.



Panasonic



Easy to use, elegant, stylish and ergonomic design

New Panasonic pop-up products designed with Silver and Golden color options as to comply with decorations of office, hotel and shopping malls on table and floor bring the priorities of users to the design concept.

First technology and functionality

Thea series modules customized with 3M and 4M options are together available on Panasonic pop-up products.

Slow or fast opening cover with a single touch

You just need to touch on a single pushbutton to open your Panasonic pop-up products slowly or fast through which you will combine Panasonic quality and technology with your mobile devices without any problem.

Options equipped with Thea modules

Pop-up products meeting the needs of users as pre-equipped with Thea modules provide ease of placing order through a single code and also has the possibility to design for the purpose of customization with Thea modules suitable for expectations when desired.

New Panasonic Pop-up sockets for table and floor

- 120 x 120 and 120 x 140 / 5 mm elegant and decorative form
- 3M and 4M options offered with Silver and Golden color alternatives
- Designs combined with Thea modules
- Tailor-made combined solutions with a single order number
- Easy to use, easy to place order
- Fast or slow opening cover with pushbutton
- Comfortable assembly privilege on table or floor
- Advanced Panasonic technology and quality



Panasonic®

Panasonic Corporation
Eco Solutions Company

Power Components Business Unit

1048, Kadoma Osaka 571-8686, Japan

**VİKO Elektrik ve Elektronik
Endüstrisi San. ve Tic. A.Ş.**

A member of the Panasonic Group

Abdurrahmangazi Mah. Ebubekir Cad. No: 44 34887 Sancaktepe
İstanbul / Türkiye T: +90 216 564 55 55 e-mail: viko@viko.com.tr
www.viko.panasonic.com