

# Corp de iluminat fluorescent cu montaj incastat tip: FIDI-19 LED

## Fluorescent luminary with recessed mounted type: FIDI-19 LED

### Instructiuni de montare si exploatare



Mounting and operating instructions

Instructions de montaj

Montageanleitung

FIDI-19 LED	●		-5...35°	~5	~230V	25.7	20	LED	●		>0.95	●	60598-1
FIDI-19 LED SIG 1H	●		-5...35°	~5	~230V	25.7	20	LED	●		>0.95	●	60598-1 60598-2-22
FIDI-19 LED SIG 3H	●		-5...35°	~5	~230V	25.7	20	LED	●		>0.95	●	60598-1 60598-2-22
FIDI-19 LED DALI	●		-5...35°	~5	~230V	25.7	20	LED	●		>0.95	●	60598-1
FIDI-19 LED DALI SIG 1H	●		-5...35°	~5	~230V	25.7	20	LED	●		>0.95	●	60598-1 60598-2-22
FIDI-19 LED DALI SIG 3H	●		-5...35°	~5	~230V	25.7	20	LED	●		>0.95	●	60598-1 60598-2-22

Montare in tavanul fals casetat-600x600  
se aseaza pe profilele T.  
Installation in coffered ceiling - 600x600  
place on T profiles

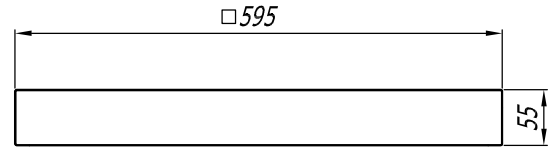
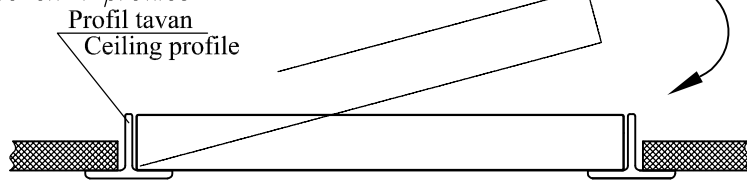

Conductor MYYM 2x0.75  
MYYM cable 2x0.75

Lmax=5m

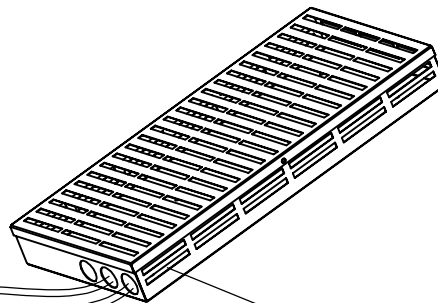

Conductor MYYM 3x0.75  
MYYM cable 3x0.75

Lmax=5m

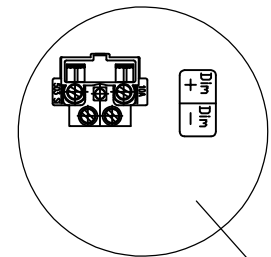

Conectare DALI  
DALI connection

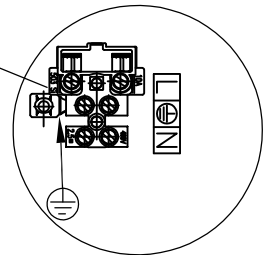

Conectare il. sig.  
Em. connection

Conectare la retea  
Power supply connection

Cablu/Cable  
Ømax 11 mm

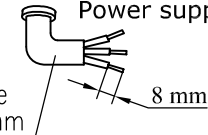

Atentie! Toate operatiile de montaj si intretinere in exploatare se vor efectua in lipsa tensiunii electrice si numai de catre persoane autorizate!

Attention! All installation and maintenance operations will be performed in absence of operating voltage and only by authorized personnel!

 Acest simbol aplicat pe produs este in conformitate cu Directiva Europeana 2002/96/CE, privind deseurile echipamentelor electrice si electronice rezultate din dezmembrarea produselor uzate si indica faptul ca produsul face obiectul unei colectari separate. Pentru prevenirea distrugerii mediului inconjurator si sanatatii umane, va rugam sa nu eliminati acest produs ca deșeu nesortat. In vederea unei reciclari sigure din punct de vedere al mediului, utilizatorii de echipamente electrice si electronice trebuie sa predea deseurile acestora la punctele de colectare selectiva special amenajate de catre autoritatile administratiei publice locale.

 This symbol applied on the product complies with European Directive 2002/96/EC, regarding electrical and electronic waste products resulting from the dismantling and indicates that the product has a separate collection. To prevent the damages on the environment and human health, do not dispose of this product as unsorted waste. For a safe recycling, the electric and electronic equipment end-users must contact the local authorities for details concerning a safe recycling.