

DIAMETRO DI FORATURA PANNELLO
 PANEL DRILLING HOLE

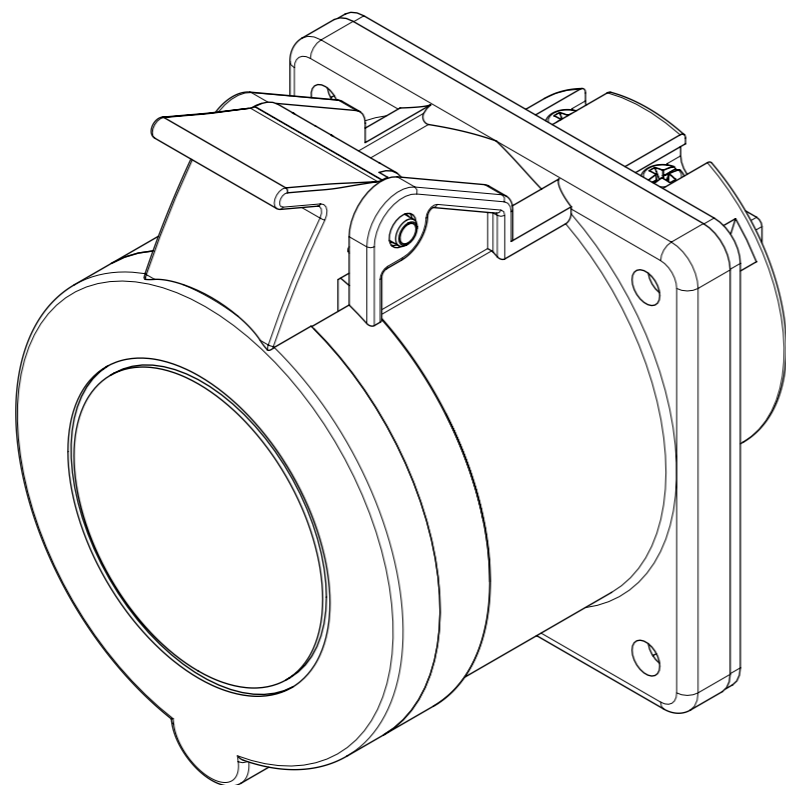
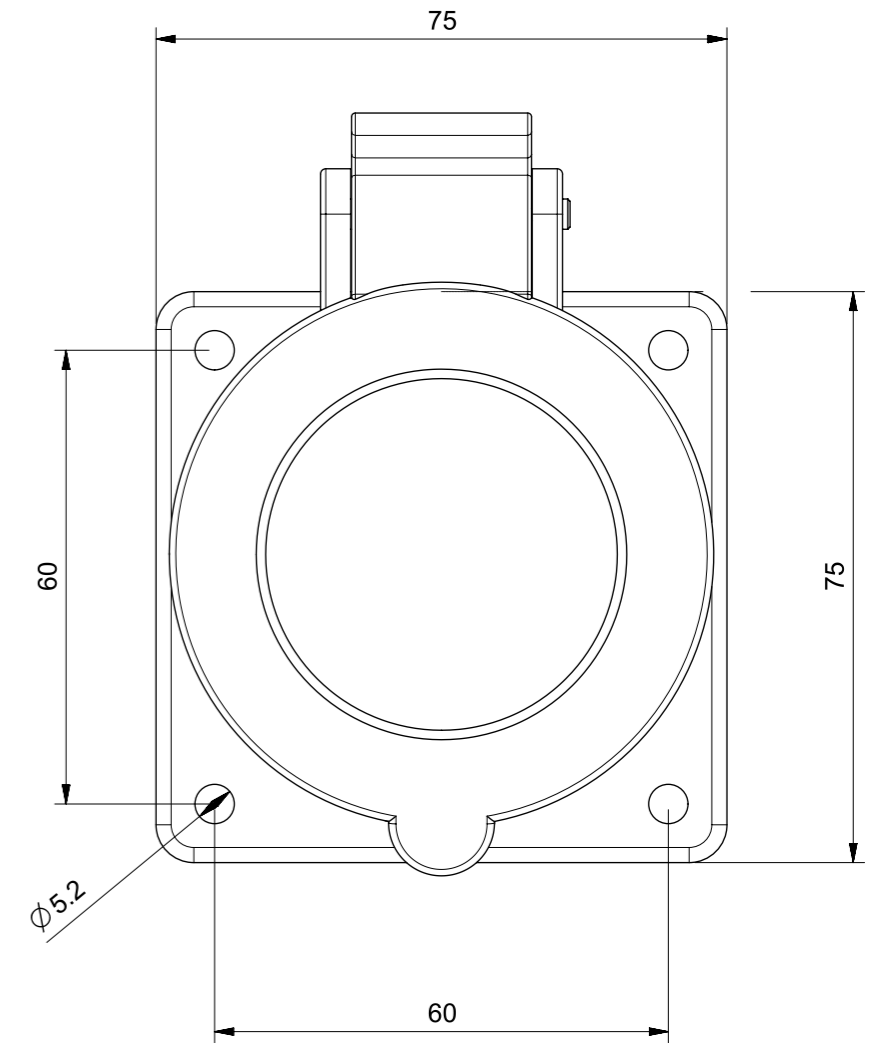
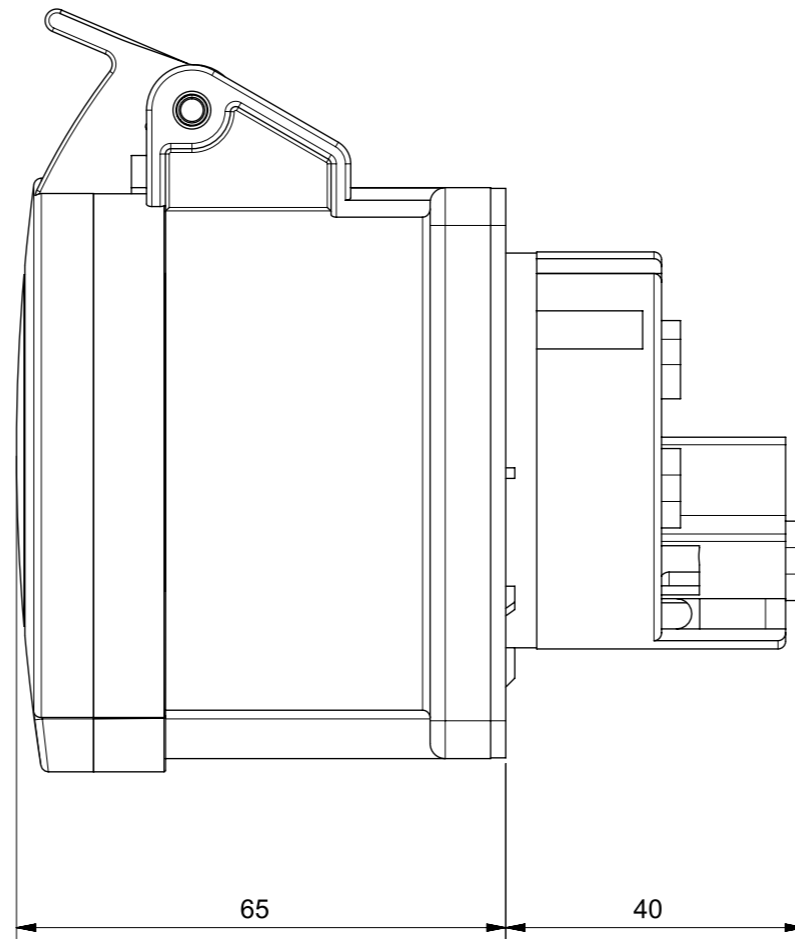

IL DISEGNO SI RIFERISCE ALLA POSIZIONE 6H
 DWG REFERS TO CLOCK POSITION 6H

At the end of the law, we reserve the ownership of this design may not be copied and transfer it to third parties or competitors	Format	A3	Scale	1:1	Mould N°	1000XXXX	Drawn	SCAME
	Tolerances for linear and angular dimensions without indication of specific tolerances: JS13 / UNI 286-1:2010							Date
 S.p.A. PARRE - (Bergamo)	DESCRIPTION						Approved	
	PRESA INCASSO DIR.3P+N 32A 44 6H						CODICE	Sheet 1 / 1