

xtrim s

recessed/surface

5 YEARS
WARRANTY

LIGHT FITTINGS FOR XTRIM S RECESSED AND SURFACE



EN

Light fittings for the XTRIM S RECESSED and XTRIM S SURFACE systems.

Available as linear luminaires with opal diffusers or reflectors, fixed or adjustable and as projectors. All these light fittings are equipped with magnetic fastening system.

IT

Apparecchi di illuminazione per sistemi XTRIM S RECESSED e XTRIM S SURFACE.

Sono disponibili apparecchi lineari con diffusori opalini o riflettori, apparecchi fissi o orientabili e proiettori. Tutti questi apparecchi sono dotati di sistema di fissaggio magnetico.

RO

Corpuri de iluminat pentru sistemele XTRIM S RECESSED și XTRIM S SURFACE.

Disponibile în versiuni de corpuri liniare, cu dispersoare opale sau reflectoare, fixe sau orientabile și proiectoare. Toate aceste corpuri de iluminat sunt dotate cu sistem magnetic de fixare.



xtrim s recessed/surface

LINEAR LIGHT FITTINGS

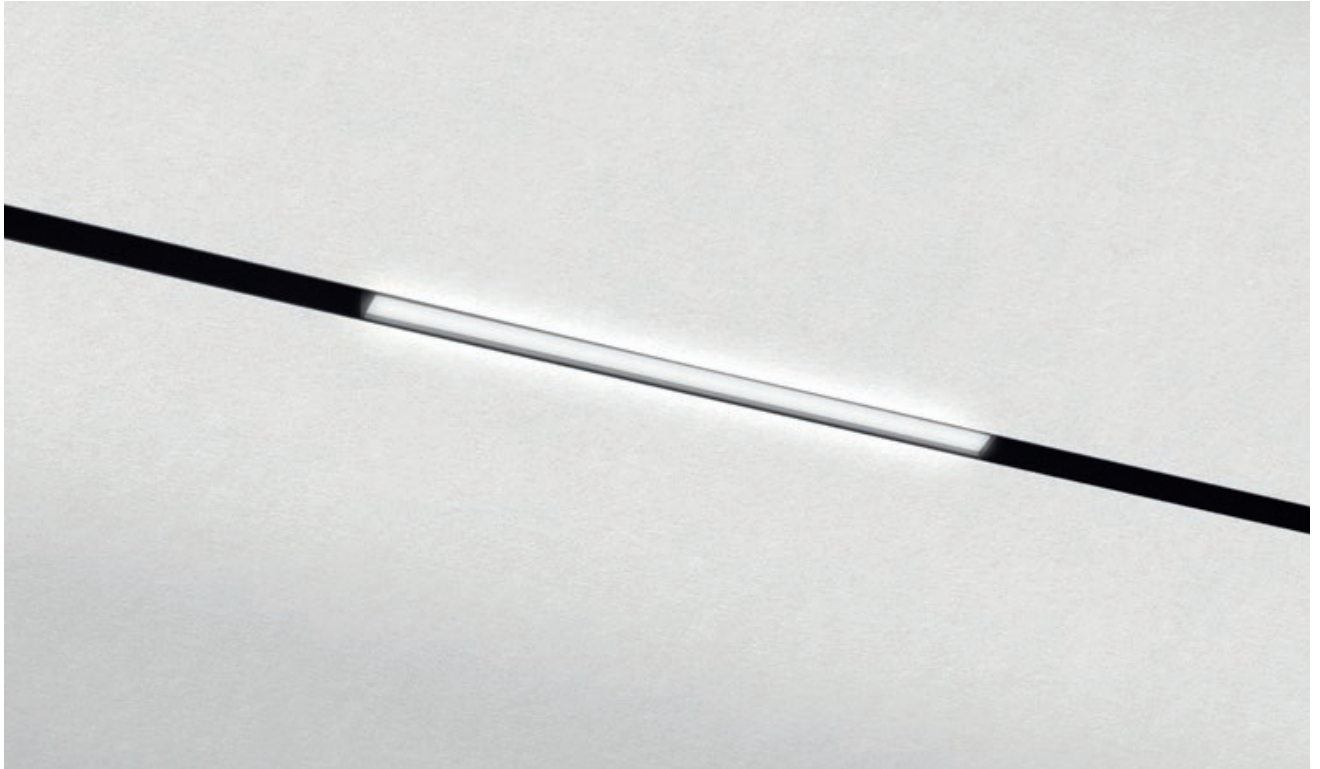

FINISHING AVAILABLE

BK

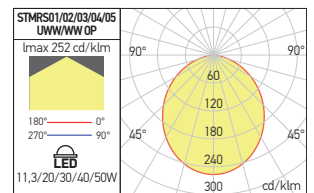
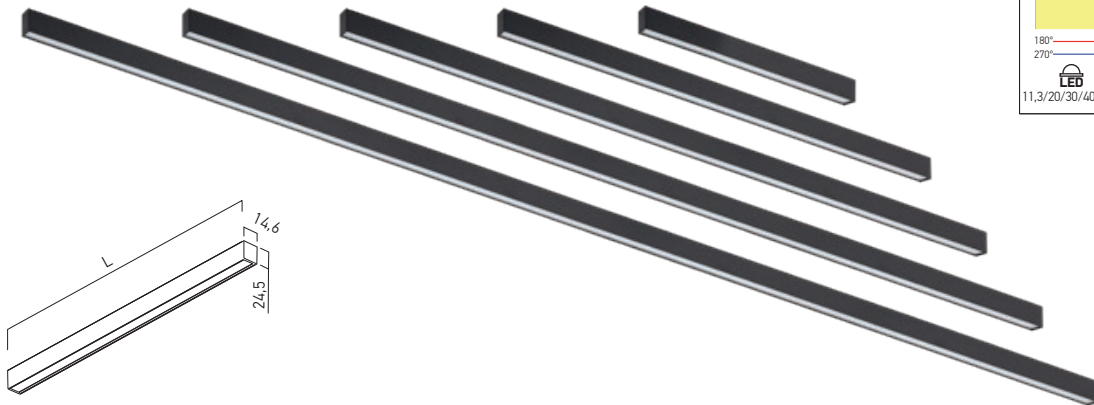

Code	Finishing	LED type	Power	Input voltage	LED flux	System flux	CCT	CRI	Optics	Length (L)	Weight
STMRS01UWW OP	BK	SMD 2835 HONGLI	11,3W	48V DC	630 lm	404 lm	2700K	80	Large	300 mm	0,12 kg
STMRS01WW OP	BK	SMD 2835 HONGLI	11,3W	48V DC	720 lm	456 lm	3000K	80	Large	300 mm	0,12 kg
STMRS02UWW OP	BK	SMD 2835 HONGLI	20W	48V DC	1250 lm	796 lm	2700K	80	Large	600 mm	0,25 kg
STMRS02WW OP	BK	SMD 2835 HONGLI	20W	48V DC	1440 lm	912 lm	3000K	80	Large	600 mm	0,25 kg
STMRS03UWW OP	BK	SMD 2835 HONGLI	30W	48V DC	1880 lm	1189 lm	2700K	80	Large	900 mm	0,37 kg
STMRS03WW OP	BK	SMD 2835 HONGLI	30W	48V DC	2160 lm	1368 lm	3000K	80	Large	900 mm	0,37 kg
STMRS04UWW OP	BK	SMD 2835 HONGLI	40W	48V DC	2500 lm	1586 lm	2700K	80	Large	1190 mm	0,47 kg
STMRS04WW OP	BK	SMD 2835 HONGLI	40W	48V DC	2880 lm	1824 lm	3000K	80	Large	1190 mm	0,47 kg
STMRS05UWW OP	BK	SMD 2835 HONGLI	50W	48V DC	3130 lm	1983 lm	2700K	80	Large	1490 mm	0,60 kg
STMRS05WW OP	BK	SMD 2835 HONGLI	50W	48V DC	3600 lm	2280 lm	3000K	80	Large	1490 mm	0,60 kg

Linear light fittings, for installation in the profiles of XTRIM S RECESSED and XTRIM S SURFACE systems, equipped with SMD LED module, opal diffusers of polystyrene and magnetic fastening system.

Housing of extruded aluminum profile, electrostatically painted.

Corpuri de iluminat liniare, pentru montajul în profilele sistemelor XTRIM S RECESSED și XTRIM S SURFACE, echipate cu modul cu LED-uri SMD, dispersoare opale din polistiren și sistem magnetic de fixare.

Structură din profil de aluminiu extrudat, vopsit în câmp electrostatic.

Apparecchi lineari, per l'installazione sui profili dei sistemi XTRIM S RECESSED e XTRIM S SURFACE, dotati di modulo a LED SMD, diffusori opalini in poliestere e sistema di fissaggio magnetico.

Corpo in profilo estruso di alluminio verniciato in campo elettrostatico.

FIX SPOTLIGHTS

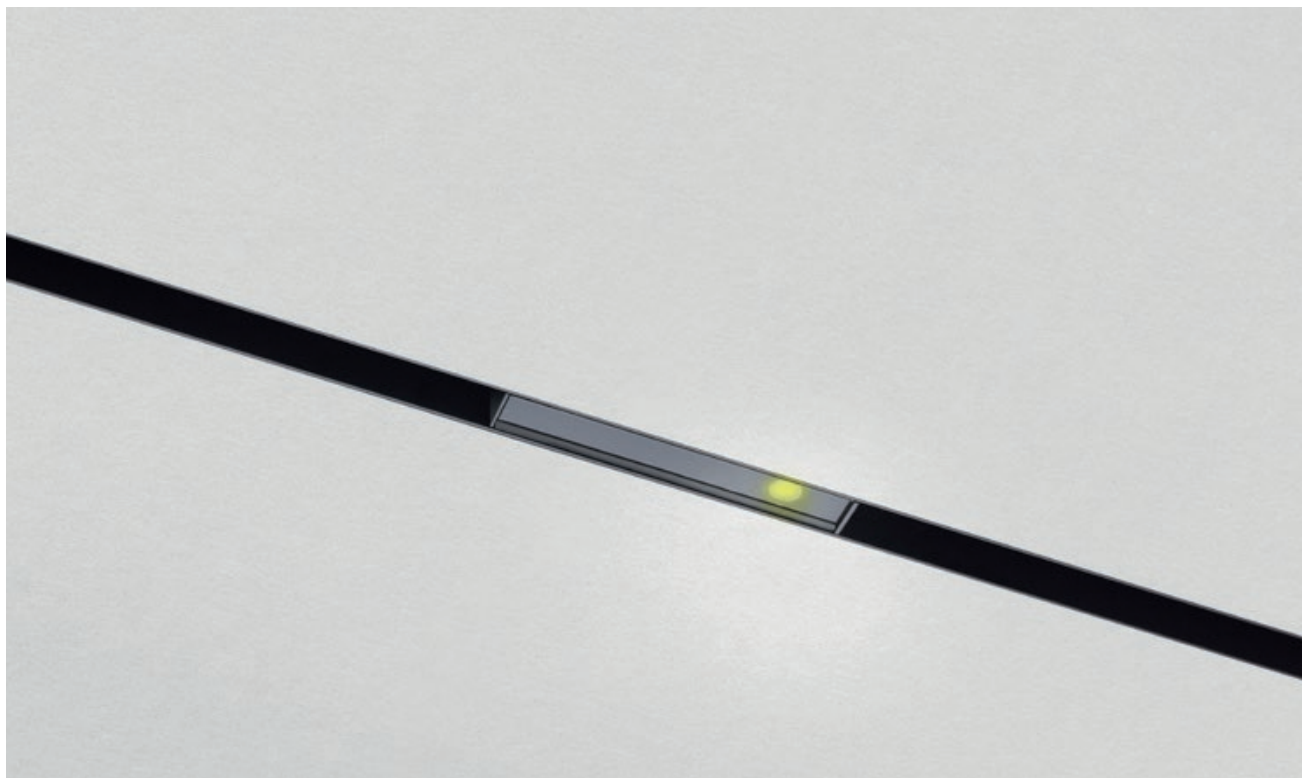

FINISHING AVAILABLE

BK

STMRS31

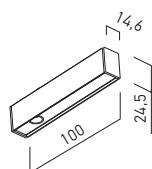

STMRS33

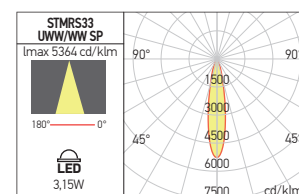
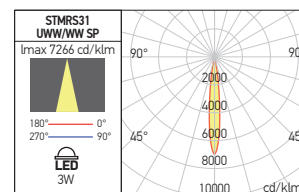
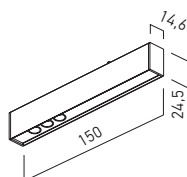

Code	Finishing	LED type	Power	Input voltage	LED flux	System flux	CCT	CRI	Optics	Weight
STMRS31UWW SP	BK	POWER LED OSRAM	3W	48V DC	270 lm	118 lm	2700K	90	20°	0,30 kg
STMRS31WW SP	BK	POWER LED OSRAM	3W	48V DC	330 lm	138 lm	3000K	90	20°	0,30 kg
STMRS33UWW SP	BK	POWER LED OSRAM	3,15W	48V DC	270 lm	161 lm	2700K	90	18°	0,70 kg
STMRS33WW SP	BK	POWER LED OSRAM	3,15W	48V DC	330 lm	192 lm	3000K	90	18°	0,70 kg

Fix spotlights for installation in the profiles of XTRIM S RECESSED and XTRIM S SURFACE systems, equipped with power LED and magnetic fastening system.

Housing of extruded aluminum profile, electrostatically painted.

Optical system UGR<10.

Spoturi fixe pentru montajul în profilele sistemelor XTRIM S RECESSED și XTRIM S SURFACE, echipat cu LED de putere și sistem magnetic de fixare.

Corp din profil de aluminiu extrudat, vopsit în câmp electrostatic.

Sistem optic UGR<10.

Faretti fissi per l'installazione su profili dei sistemi XTRIM S RECESSED e XTRIM S SURFACE, dotato di LED di potenza e sistema di fissaggio magnetico.

Corpo in profilo estruso di alluminio verniciato in campo elettrostatico.

Sistema ottico UGR<10.

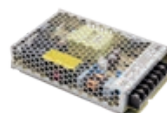

RECOMMENDED CV DRIVERS
AT48 SERIE

xtrim s recessed/surface

ADJUSTABLE MINI PROJECTORS



RECOMMENDED CV DRIVERS
AT48 SERIE

FINISHING AVAILABLE

BK

STMRS41



FINISHING AVAILABLE

BK

STMRS42



Code	Finishing	LED type	Power	Input voltage	LED flux	System flux	CCT	CRI	Optics	Weight
STMRS41UWW SP	BK	POWER LED CREE	8,4W	48V DC	600 lm	371 lm	2700K	90	14°	0,15 kg
STMRS41WW SP	BK	POWER LED CREE	8,4W	48V DC	690 lm	427 lm	3000K	90	14°	0,15 kg
STMRS42UWW SP	BK	POWER LED CREE	8,2W	48V DC	600 lm	406 lm	2700K	90	6°	0,28 kg
STMRS42WW SP	BK	POWER LED CREE	8,2W	48V DC	690 lm	466 lm	3000K	90	6°	0,28 kg

Adjustable and dimmable mini projectors for installation in the profiles of XTRIM S RECESSED and XTRIM S SURFACE systems, equipped with power LEDs, satin diffusers of polystyrene and magnetic fastening systems.

Optical system UGR<16.

Housing of extruded aluminum profile, electrostatically painted.

Mini proiectoare orientabile și dimabile pentru montajul în profilele sistemelor XTRIM S RECESSED și XTRIM S SURFACE, echipate cu LED-uri de putere, dispersoare satinat din polistiren și sisteme magnetice de fixare. Sistem optic UGR<16.

Corp din profil de aluminiu extrudat, vopsit în câmp electrostatic.

Mini proiettori orientabili e dimmerabili per l'installazione su profili dei sistemi XTRIM S RECESSED e XTRIM S SURFACE, dotati di LED di potenza, diffusore satinato in polistirene e sistema di fissaggio magnetico.

Sistema ottico UGR<16.

Corpo in profilo estruso di alluminio verniciato in campo elettrostatico.

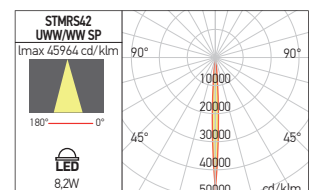
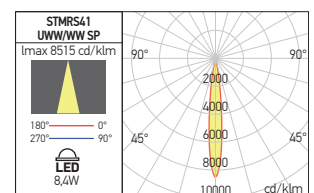

DECORATIVE SPHERICAL LIGHT FITTING

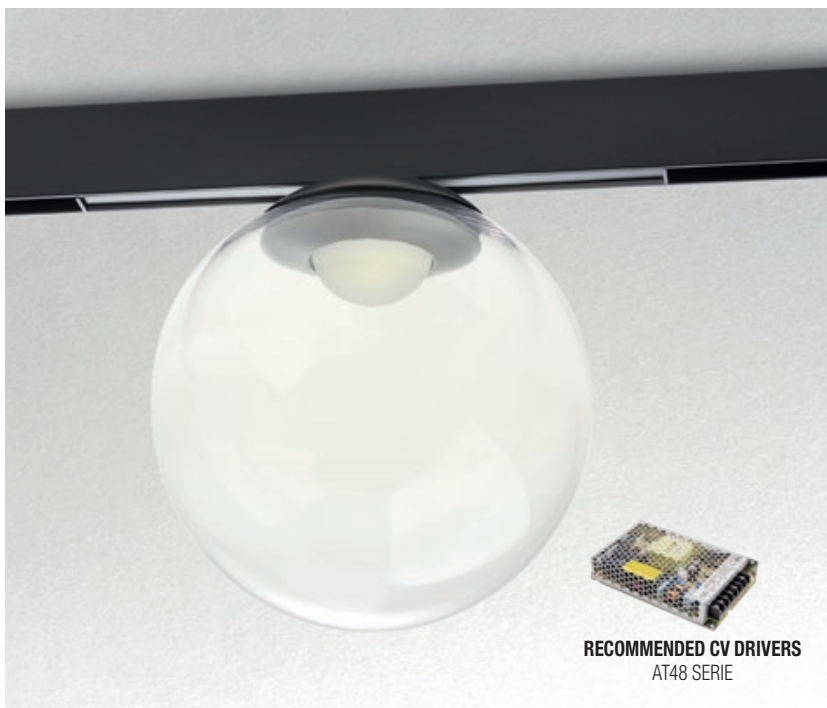

STMRS51

FINISHING AVAILABLE

BK

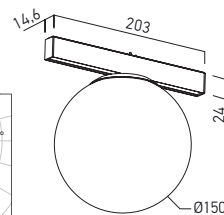
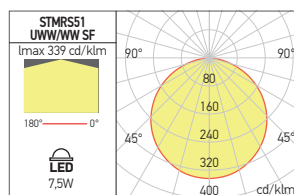

RECOMMENDED CV DRIVERS
AT48 SERIE

Code	Finishing	LED type	Power	Input voltage	LED flux	System flux	CCT	CRI	Optics	Weight
STMRS51UWW SF	BK	COB LUMINUS	7,5W	48V DC	570 lm	367 lm	2700K	90	Large	0,52 kg
STMRS51WW SF	BK	COB LUMINUS	7,5W	48V DC	650 lm	421 lm	3000K	90	Large	0,52 kg

Decorative light fitting with spherical shape, for installation in the profiles of XTRIM S RECESSED and XTRIM S SURFACE systems, equipped with power LED, warm white color temperature and magnetic fastening system.

Corp de iluminat decorativ cu formă sferică, pentru montajul în profilele sistemelor XTRIM S RECESSED și XTRIM S SURFACE, echipat cu LED de putere, temperatură de culoare alb cald și sistem magnetic de fixare.

Apparecchio decorativo sferico, per l'installazione nei profili dei sistemi XTRIM S RECESSED e XTRIM S SURFACE, dotato di LED di potenza, temperatura di colore bianco caldo e sistema di fissaggio magnetico.

DECORATIVE PANEL LIGHT FITTING



STMRS53

FINISHING AVAILABLE

MWH

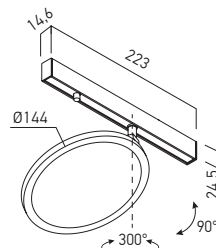
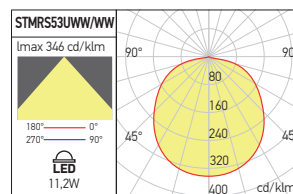

RECOMMENDED CV DRIVERS
AT48 SERIE

Code	Finishing	LED type	Power	Input voltage	LED flux	System flux	CCT	CRI	Optics	Weight
STMRS53UWW PN	MWH	SMD 3014 EDISON	11,2W	48V DC	1150 lm	534 lm	2700K	90	Large	0,35 kg
STMRS53WW PN	MWH	SMD 3014 EDISON	11,2W	48V DC	1320 lm	611 lm	3000K	90	Large	0,35 kg

Decorative light fitting, panel type, dimmable (PWM), for installation in the profiles of XTRIM S RECESSED and XTRIM S SURFACE systems, equipped with SMD LEDs and magnetic fastening system.

Corp de iluminat decorativ tip panou cu LED-uri, dimabil (PWM), pentru montajul în profilele sistemelor XTRIM S RECESSED și XTRIM S SURFACE, echipat cu LED-uri SMD și sistem magnetic de fixare.

Apparecchio decorativo tipo pannello a LED, dimmerabile (PWM), per l'installazione nei profili dei sistemi XTRIM S RECESSED e XTRIM S SURFACE, dotato di LED SMD e sistema di fissaggio magnetico.

xtrim s recessed/surface

ADJUSTABLE LINEAR LIGHT FITTINGS



Adjustable linear light fittings, for installation in the profiles of XTRIM S RECESSED and XTRIM S SURFACE systems, equipped with SMD LEDs modules, opal diffusers of polystyrene and magnetic fastening systems. Housing of extruded aluminum profile, electrostatically painted.

Corpuri de iluminat liniare orientabile, pentru montajul în profilele sistemelor XTRIM S RECESSED și XTRIM S SURFACE, echipate cu module cu LED-uri SMD, dispersoare opale din polistiren și sisteme magnetice de fixare. Corp din profil de aluminiu extrudat, vopsit în câmp electrostatic.

Apparecchi lineari orientabili, per l'installazione su profili dei sistemi XTRIM S RECESSED e XTRIM S SURFACE, dotati di moduli a LED SMD, diffusori opalini in polistirene e sistemi di fissaggio magnetico. Corpo in profilo estruso di alluminio verniciato in campo elettrostatico.

FINISHING AVAILABLE

BK

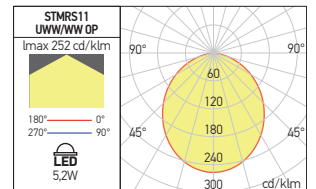
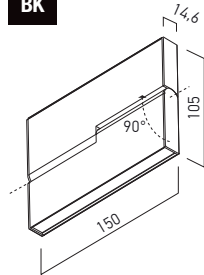

Code	Finishing	LED type	Power	Input voltage	LED flux	System flux	CCT	CRI	Optics	Weight
STMRs11UWW OP	BK	SMD 2835 HONGLI	5,2W	48V DC	240 lm	179 lm	2700K	80	Large	0,32 kg
STMRs11WW OP	BK	SMD 2835 HONGLI	5,2W	48V DC	275 lm	206 lm	3000K	80	Large	0,32 kg

FINISHING AVAILABLE

BK

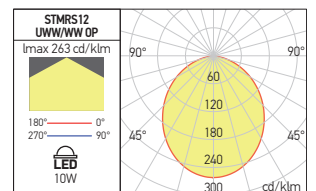
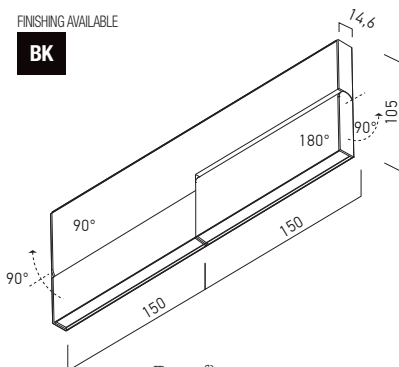

Code	Finishing	LED type	Power	Input voltage	LED flux	System flux	CCT	CRI	Optics	Weight
STMRs12UWW OP	BK	SMD 2835 HONGLI	10W	48V DC	480 lm	398 lm	2700K	80	Large	0,61 kg
STMRs12WW OP	BK	SMD 2835 HONGLI	10W	48V DC	550 lm	456 lm	3000K	80	Large	0,61 kg

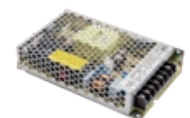

RECOMMENDED CV DRIVERS
AT48 SERIE

ADJUSTABLE LINEAR PROJECTORS



Adjustable linear projectors, for installation in the profiles of XTRIM S RECESSED and XTRIM S SURFACE systems, equipped with power LEDs, FRESNEL lenses in PMMA and magnetic fastening system.

Optical system UGR<16.

Housing of extruded aluminum profile, electrostatically painted.

Proiectoare liniare orientabile, pentru montajul în profilele sistemelor XTRIM S RECESSED și XTRIM S SURFACE, echipate cu LED-uri de putere, lentile FRESNEL din PMMA și sistem magnetic de fixare.

Sistem optic UGR<16.

Corp din profil de aluminiu extrudat, vopsit în câmp electrostatic.

Proiettori lineari orientabili per installazione su profili dei sistemi XTRIM S RECESSED e XTRIM S SURFACE, dotati di LED di potenza, lenti FRESNEL in PMMA e sistema di fissaggio magnetico.

Sistema ottico UGR<16.

Corpo in profilo estruso di alluminio verniciato in campo elettrostatico.

FINISHING AVAILABLE

BK

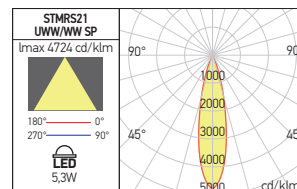
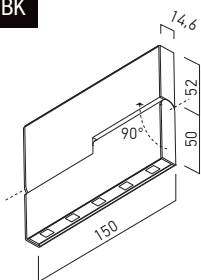

Code	Finishing	LED type	Power	Input voltage	LED flux	System flux	CCT	CRI	Optics	Weight
STMRs21UWW SP	BK	POWER LED OSRAM	5,3W	48V DC	510 lm	369 lm	2700K	90	20°	0,50 kg
STMRs21WW SP	BK	POWER LED OSRAM	5,3W	48V DC	580 lm	424 lm	3000K	90	20°	0,50 kg

FINISHING AVAILABLE

BK

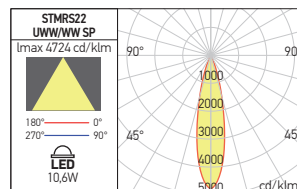
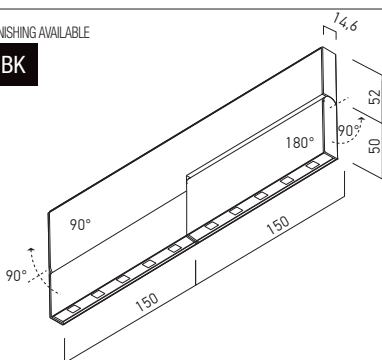

Code	Finishing	LED type	Power	Input voltage	LED flux	System flux	CCT	CRI	Optics	Weight
STMRs22UWW SP	BK	POWER LED OSRAM	10,6W	48V DC	1020 lm	738 lm	2700K	90	20°	1,00 kg
STMRs22WW SP	BK	POWER LED OSRAM	10,6W	48V DC	1160 lm	848 lm	3000K	90	20°	1,00 kg

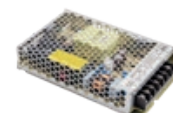

RECOMMENDED CV DRIVERS
AT48 SERIE