



Complete system for the connection and distribution of LAN networks in residential and tertiary sector environments. The range includes fibre optic solutions, wall panels, floor cabinets and copper wiring products.

Data Center boards and cabinets are available in a wide choice of modularity and different depths (up to 1000mm), to adapt to every application need.

Made with high quality materials (static flow at full load can reach 1000kg), the products are also characterised by their simple wiring (thanks to large internal volumes) and complete customisation, with removable and reversible front doors.

Categorie	19" wall-mount cabinet	Material	Oțel
Finisare	Textured	Culoare	Grey (RAL 7035)
Unitate de cablaj	12 U	Tip de ușă	Reversible
Door opening	180°	Static load capacity	50 kilogram
No. uprights	2	Profunzime (mm)	400 mm
Dim. exterioare LxHxP (mm)	600x605x400	Clasă de protecție IP	IP20
Electrocod	3752		

DIMENSIONAL

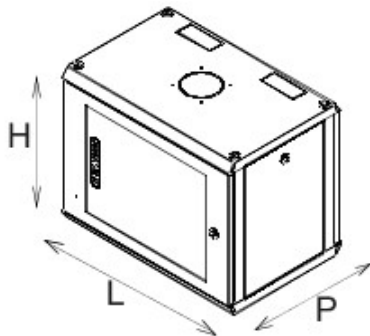

	H	L	P	
GW 38 406	335	600	400	6U
GW 38 407	470	600	400	9U
GW 38 408	605	600	400	12U
GW 38 409	740	600	400	15U
GW 38 418	605	600	600	12U
GW 38 419	740	600	600	15U

TECHNICAL SYMBOLOGY

IP

IP20

STANDARDS/APPROVALS



GEWISS S.p.A. Via A. Volta, 1
24069 Cenate Sotto - Bergamo - Italy
tel. +39 035 94 61 11 fax +39 035 94 69 09

www.gewiss.com
sat@gewiss.com
Last update 19/08/2021

Data, measures, designs and pictures are shown only as informative purposes, and could be changed without previous notice