

Smart [PRO] 2.0



SMART [PRO] 2.0 is a medium power outdoor and indoor LED projector, suitable for lighting sports areas and facilities. It can be installed on the wall, ceiling or ground thanks to the polyester powder coated galvanised steel bracket, with trivalent passivation, equipped with adjustable goniometric scale and supplied in kit. The body is produced in aluminium die casting EN AB 46100, with integrated passive heat sink, powder coated polyester with trivalent passivation. Metal core PCB with CSP LED. Reflector made of metallic HT PC or anodised and polished aluminium. Hardened front glass with 4mm thickness, anti-ageing silicone seals and A2 stainless steel exterior screws. Plastic venting and anti-condensation device. Electrical connection via IP68 connector for 1.5mm² cables. Insulation class 1. Driver integrated in options 1-10 V or DALI. Available with nine different types of optics, three types of Colour Temperature (3,000K/4,000K/5,700K) and two different types of Chromatic Yield Index (CRI>70, CRI>80). Designed to withstand surges up to 5KV (RCCB mode) and 10KV (common mode), temperature variations from -30°C to +50°C, water and dust penetration up to IP66 protection and impacts up to IK08.

GENERAL INFORMATION		OPTIC AND ILLUMINATING FEATURES	
Context	Sport, Big Areas	Optică	S2 - Symmetric Medium
Luminaire	LED luminaire with small, mid and high lumen power	Unified Glare Rating	G*6 - ULOR = 0
Aplicație	Intern / Extern	Lumină ieșire (lm)	20300
Unique digital code (Datamatrix)	Currently not present	Efficiency (lm/W)	123
Culoare	Gri grafit	Culoare Temperatură	4000 K
Tip sursă de lumină	LED - Neînlocuibil	Color Rendering Index	CRI>70
Puterea sistemului	165 W	Standard Deviation Colour Matching	SDCM = 5
LED Lifetime	L90B10(Tq25°C)=50.000h; L80B10(Tq25°C)=110.000h	Photobiological Risk Class	-
Greutate (Kg)	5.7	Standard	EN60598-1; EN60598-2-5; EN60598-2-24; IEC 62778; IEC62471; EN13201
Garanție	5 ani	ELETRICAL AND LIGHTING FEATURES	
Temperatură de stocare	-	Tensiune de alimentare	220 - 240 V
Operating temperature	-30 +40 °C	Frecvență nominală (Hz)	50 / 60
MATERIALS		Driver	Included
Body	Aluminiu turnat	Driver failure rate	F10 = 100.000h Tq25°C
Ecran	Flat tempered glass 4mm	Overvoltage protection	DM 6 kV / CM 10 kV
Optic	Polished anodised aluminum reflector with 99.99% pure aluminum	Control System	Autonom - 1/10V
Gasket	Anti-ageing silicone	INSTALLATION AND MAINTENANCE	
Locking Hook	Hexagonal metric screws	Mouting and installation	High-mast lighting - Wall mounting - Ground mouting
External screw	Stainless steel	Tilt	Rotation on bracket with integrated goniometer
Colour	Polyester powder coated	Wiring	Watertight connector
STANDARDS AND APPROVALS		Prindere	Consolă
Clasificare	-	Optic Maintenance	Not available
Dispozitiv cu temperatură la suprafață redusă	Da	LED Maintenance	Not available
Certificare DIN 18032-3	Da	Driver Box	Integrat
IPEA	-	Suprafață maximă expusă la vânt	0,085 m2
Clasă izolație	I		-
Clasă de protecție IP	IP66		-
Cod IK	IK08		-
Glow Test conductori	-		-

DIMENSIONAL

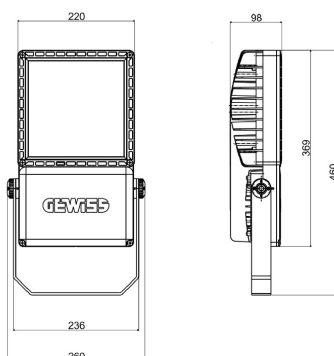

PHOTOMETRIC DISTRIBUTION

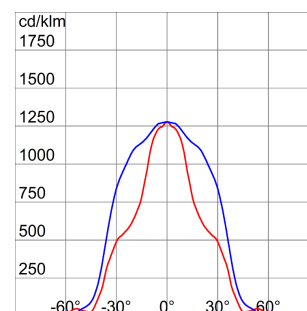

Smart [PRO] 2.0

TECHNICAL SYMBOLOGY



IP
IP66

IK
IK08

GWT
-

STANDARDS/APPROVALS

