

Gama ROAD [5]



Sistem de prindere pentru iluminat stradal cu LED HIGH POWER, format din capac, cadru și cuplaj pe stâlp cu conținut redus de cupru EN AB 46100 aluminiu turnat vopsit cu pulbere de poliester. Adekvat pentru capete de stâlp și consolă laterală, cu înclinare reglabilă în 5 pași. Sistem de deschidere și de închidere cu mâner frontal integrat. Sticlă câlită de acoperire (grosime 4 mm). Intrare cablu PG13,5. Cuțit de siguranță. Ramă cablată din PA6.6+GF. Placă de circuite imprimate (PCB) cu nucleu metalic. Sistem optic de policarbonat metalizat. Protecție la supratensiune până la 10 kV (mod comun).

GENERAL INFORMATION

Context	Street and parking lighting
Luminaire	LED Road Equipment
Aplicație	Exterior
Unique digital code (Datamatrix)	Currently not present

Culoare	Gri grafit
Tip sursă de lumină	LED - Neînlocuibil
System power	54 W @ 0.7A
LED Lifetime	L90B10(Tq25°C)>115.000h; L90B10(Tq50°C)=115.000h

Greutate (Kg)	6.6
---------------	-----

Garanție	5 ani
----------	-------

Temperatură de stocare	-
------------------------	---

Operating temperature	-25 +50 °C
-----------------------	------------

MATERIALS

Body	Aluminiu turnat
------	-----------------

Ecran	4mm thick flat tempered glass
-------	-------------------------------

Optic	Metallized polycarbonate reflector
-------	------------------------------------

Gasket	Anti-aging silicone
--------	---------------------

Locking Hook	Integrated front handle
--------------	-------------------------

External screw	Oțel
----------------	------

Colour	Powder coating
--------	----------------

STANDARDS AND APPROVALS

Clasificare	-
-------------	---

Dispozitiv cu temperatură la suprafață redusă	-
---	---

Certificare DIN 18032-3	-
-------------------------	---

IPEA	-
------	---

Clasă izolație	II
----------------	----

Clasă de protecție IP	IP66
-----------------------	------

Cod IK	IK08
--------	------

Glow Test conductori	-
----------------------	---

OPTIC AND ILLUMINATING FEATURES

Optică	HUGE
Unified Glare Rating	G*3 - ULOR = 0
Lumină ieșire (lm)	6000

Efficiency (lm/W)	111
-------------------	-----

Culoare Temperatură	4000 K
---------------------	--------

Color Rendering Index	CRI>70
-----------------------	--------

Standard Deviation Colour Matching	SDCM = 5
------------------------------------	----------

Photobiological Risk Class	RG0
----------------------------	-----

Standard	EN 60598-2-3, EN 60598-1 IEC/TR 62778
----------	---------------------------------------

ELETRICAL AND LIGHTING FEATURES

Tensiune de alimentare	220 - 240 V
------------------------	-------------

Frecvență nominală (Hz)	50 / 60
-------------------------	---------

Driver failure rate	F10=100.000h Tq25°C/75.000h Tq50°C
---------------------	------------------------------------

Driver	Included
--------	----------

Overvoltage protection	DM 10KV / CM 10KV
------------------------	-------------------

Control System	Regim dual cu autoînvățare
----------------	----------------------------

INSTALLATION AND MAINTENANCE

Mouting and installation	Pole Head - Outreach
--------------------------	----------------------

Tilt	Console cu acces pe laterală-20° + +10° - -10° + +20° cap de stâlp
------	--

Wiring	Înterupător secționator
--------	-------------------------

Prindere	Pole Head - Outreach
----------	----------------------

Optic Maintenance	Not available
-------------------	---------------

LED Maintenance	Not available
-----------------	---------------

Driver Box	Integrat
------------	----------

Suprafață maximă expusă la vânt	0,15 m²
---------------------------------	---------

DIMENSIONAL

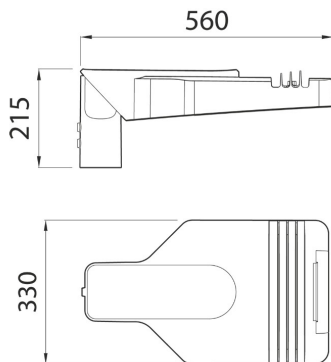

PHOTOMETRIC DISTRIBUTION

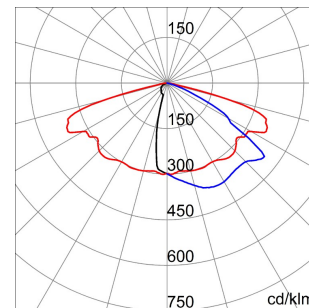

TECHNICAL SYMBOLOGY



IP
IP66

IK
IK08

GWT
-

Gama ROAD [5]

STANDARDS/APPROVALS

