

PRODUCT FAMILY DATASHEET

PARATHOM MR16

Low-voltage LED reflector lamps MR16 with retrofit pin base



AREAS OF APPLICATION

- Shops
- Hospitality
- Museums, art galleries
- Residential interiors
- As a downlight for marking walkways, doors, stairs, etc.
- Spotlighting for accents
- Display cabinets and shop windows
- Spotlighting heat-sensitive objects such as food, plants, etc.
- Outdoor applications only in suitable luminaires

PRODUCT BENEFITS

- Long lifetime of up to 15,000 h
- Low energy consumption
- Easy replacement of halogen lamps due to compact full glass design and single optic
- Instant 100 % light, no warm-up time
- Ideal for economical spotlighting

PRODUCT FEATURES

- Professional LED alternative to low voltage halogen lamps
- Made in Germany (versions up to 35 W)
- Mercury-free lamps



TECHNICAL DATA

Product description	Electrical data					Photometrical data				
	Nominal wattage	Nominal voltage	Claimed equiv. conventional lamp power	Max. lamp no. on circuit break. 10 A (B)	Max. lamp no. on circuit break. 16 A (B)	Luminous intensity [PIM]	Nominal luminous flux	Rated luminous flux	Color temperature	Lumen main.fact.at end of nom.life time
P MR16 20 36° 2.9 W/2700K GU5.3 ¹⁾	2.90 W	12 V	20 W	21	35	600 cd	230 lm	230 lm	2700 K	0.70
P MR16 20 36° 2.9 W/3000K GU5.3 ¹⁾	2.90 W	12 V	20 W	21	35	600 cd	230 lm	230 lm	3000 K	0.70
P MR16 20 36° 2.9 W/4000K GU5.3 ¹⁾	2.90 W	12 V	20 W	21	35	600 cd	230 lm	230 lm	4000 K	0.70
P MR16 35 36° 4.6 W/2700K GU5.3 ¹⁾	4.60 W	12 V	35 W	21	35	950 cd	350 lm	350 lm	2700 K	0.70
P MR16 35 36° 4.6 W/3000K GU5.3 ¹⁾	4.60 W	12 V	35 W	21	35		350 lm	350 lm	3000 K	0.70
P MR16 35 36° 4.6 W/4000K GU5.3 ¹⁾	4.60 W	12 V	35 W	21	35	950 cd	350 lm	350 lm	4000 K	0.70
P MR16 50 36° 7.2 W/2700K GU5.3 ¹⁾	7.20 W	12 V	50 W	20	33	1430 cd	621 lm	621 lm	2700 K	0.70
P MR16 50 36° 7.2 W/3000K GU5.3 ¹⁾	7.20 W	12 V	50 W	20	33	1430 cd	621 lm	621 lm	3000 K	0.70
P MR16 50 36° 7.2 W/4000K GU5.3 ¹⁾	7.20 W	12 V	50 W	20	33	1430 cd	621 lm	621 lm	4000 K	0.70

Product description	Light color (designation)	Color temperature	Luminous flux	Color rendering index Ra	Light technical data		Dimensions & weight		Temperatures & operating conditions
					Beam angle	Warm-up time (60 %)	Overall length	Diameter	Maximum temperature at tc test point
P MR16 20 36° 2.9 W/2700K GU5.3 ¹⁾	Warm White	2700 K	230 lm	≥80	36 °	< 0.50 s	46.0 mm	51.0 mm	69 °C
P MR16 20 36° 2.9 W/3000K GU5.3 ¹⁾	Warm White	3000 K	230 lm	≥80	36 °	< 0.50 s	46.0 mm	51.0 mm	69 °C
P MR16 20 36° 2.9 W/4000K GU5.3 ¹⁾	Cool White	4000 K	230 lm	≥80	36 °	< 0.50 s	46.0 mm	51.0 mm	69 °C
P MR16 35 36° 4.6 W/2700K GU5.3 ¹⁾	Warm White	2700 K	350 lm	≥80	36 °	< 0.50 s	46.0 mm	51.0 mm	77 °C
P MR16 35 36° 4.6 W/3000K GU5.3 ¹⁾	Warm White	3000 K	350 lm	≥80	36 °	< 0.50 s	46.0 mm	51.0 mm	77 °C
P MR16 35 36° 4.6 W/4000K GU5.3 ¹⁾	Cool White	4000 K	350 lm	≥80	36 °	< 0.50 s	46.0 mm	51.0 mm	77 °C
P MR16 50 36° 7.2 W/2700K GU5.3 ¹⁾	Warm White	2700 K	621 lm	≥80	36 °	< 0.50 s	53.0 mm	51.0 mm	90 °C
P MR16 50 36° 7.2 W/3000K GU5.3 ¹⁾	Warm White	3000 K	621 lm	≥80	36 °	< 0.50 s	53.0 mm	51.0 mm	90 °C
P MR16 50 36° 7.2 W/4000K GU5.3 ¹⁾	Cool White	4000 K	621 lm	≥80	36 °	< 0.50 s	53.0 mm	51.0 mm	90 °C

Product description	Lifespan		Additional product data			Capabilities	Certificates & standards	
	Nominal lamp life time	Number of switching cycles	Base (standard designation)	Mercury content	Mercury-free	Dimmable	Energy efficiency class	Energy consumption
P MR16 20 36° 2.9 W/2700K GU5.3 ¹⁾	15000 h	100000	GU5.3	0.0 mg	Yes	No	A+	3 kWh/1000h
P MR16 20 36° 2.9 W/3000K GU5.3 ¹⁾	15000 h	100000	GU5.3	0.0 mg	Yes	No	A+	3 kWh/1000h
P MR16 20 36° 2.9 W/4000K GU5.3 ¹⁾	15000 h	100000	GU5.3	0.0 mg	Yes	No	A+	3 kWh/1000h
P MR16 35 36° 4.6 W/2700K GU5.3 ¹⁾	15000 h	100000	GU5.3	0.0 mg	Yes	No	A+	5 kWh/1000h
P MR16 35 36° 4.6 W/3000K GU5.3 ¹⁾	15000 h	100000	GU5.3	0.0 mg	Yes	No	A+	5 kWh/1000h
P MR16 35 36° 4.6 W/4000K GU5.3 ¹⁾	15000 h	100000	GU5.3	0.0 mg	Yes	No	A+	5 kWh/1000h
P MR16 50 36° 7.2 W/2700K GU5.3 ¹⁾	15000 h	100000	GU5.3	0.0 mg	Yes	No	A+	8 kWh/1000h
P MR16 50 36° 7.2 W/3000K GU5.3 ¹⁾	15000 h	100000	GU5.3	0.0 mg	Yes	No	A+	8 kWh/1000h
P MR16 50 36° 7.2 W/4000K GU5.3 ¹⁾	15000 h	100000	GU5.3	0.0 mg	Yes	No	A+	8 kWh/1000h

Product description	Country-specific categorizations
	ILCOS
P MR16 20 36° 2.9 W/2700K GU5.3 ¹⁾	DRR-2,9/827-12-GU5,3-50/36
P MR16 20 36° 2.9 W/3000K GU5.3 ¹⁾	
P MR16 20 36° 2.9 W/4000K GU5.3 ¹⁾	DRR-2,9/840-12-GU5,3-50/36
P MR16 35 36° 4.6 W/2700K GU5.3 ¹⁾	DRR-4,6/827-12-GU5,3-50/36
P MR16 35 36° 4.6 W/3000K GU5.3 ¹⁾	
P MR16 35 36° 4.6 W/4000K GU5.3 ¹⁾	DRR-4,6/840-12-GU5,3-50/36
P MR16 50 36° 7.2 W/2700K GU5.3 ¹⁾	DRR-7,2/827-12-GU5,3-50/36
P MR16 50 36° 7.2 W/3000K GU5.3 ¹⁾	DRR-7,2/830-12-GU5,3-50/36
P MR16 50 36° 7.2 W/4000K GU5.3 ¹⁾	DRR-7,2/840-12-GU5,3-50/36

¹⁾ All technical parameters apply to the entire lamp/Due to the complex production process for light-emitting diodes, the typical values shown for the technical LED parameters are purely statistical values that do not necessarily match the actual technical parameters of each individual product, which can vary from the typical value

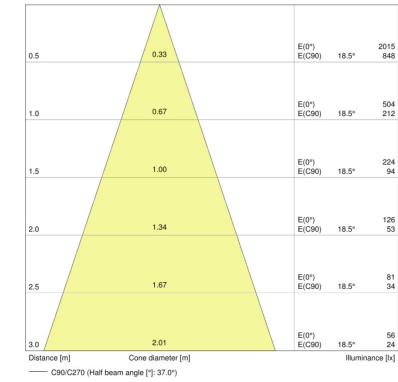
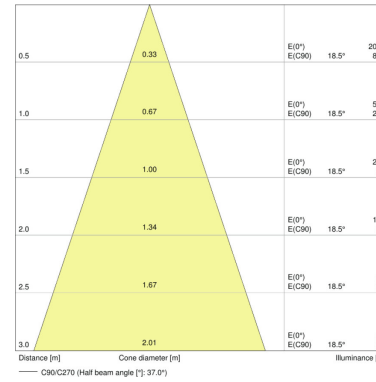
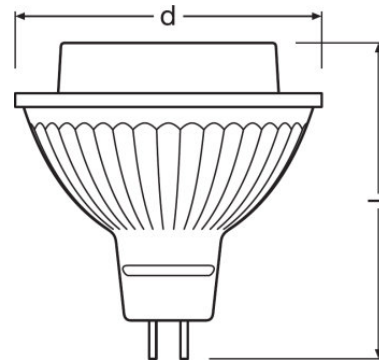
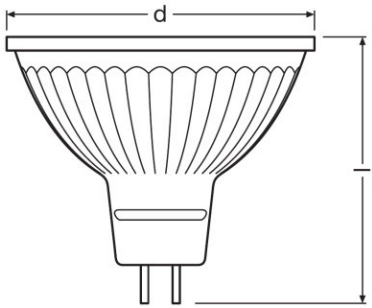

P MR16 20 36° 2.9 W/2700K GU5.3, P
MR16 20 36° 2.9 W/3000K GU5.3, P
MR16 20 36° 2.9 W/4000K GU5.3, P
MR16 35 36° 4.6 W/2700K GU5.3, P
MR16 35 36° 4.6 W/3000K GU5.3, P
MR16 35 36° 4.6 W/4000K GU5.3

P MR16 50 36° 7.2 W/2700K GU5.3, P
MR16 50 36° 7.2 W/3000K GU5.3, P
MR16 50 36° 7.2 W/4000K GU5.3

P MR16 20 36° 2.9 W/2700K GU5.3

P MR16 20 36° 2.9 W/3000K GU5.3

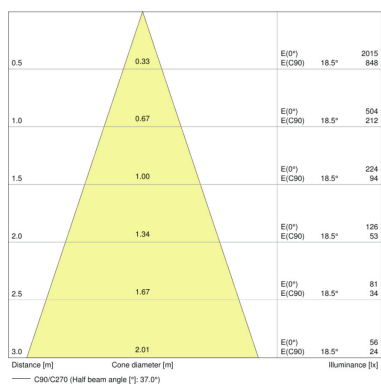

P MR16 20 36° 2.9 W/4000K GU5.3

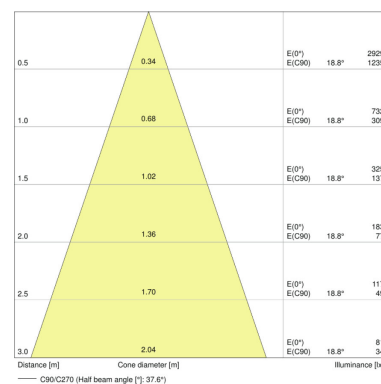

P MR16 35 36° 4.6 W/2700K GU5.3

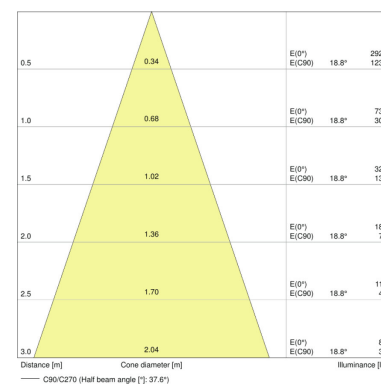

P MR16 35 36° 4.6 W/3000K GU5.3

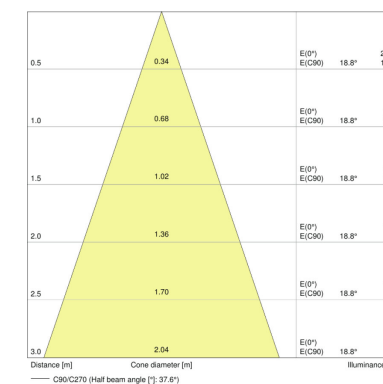

P MR16 35 36° 4.6 W/4000K GU5.3

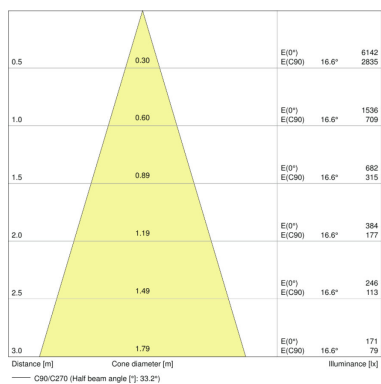

P MR16 50 36° 7.2 W/2700K GU5.3

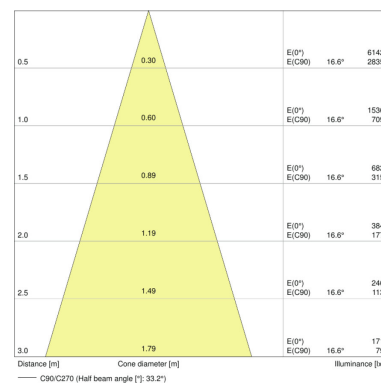

P MR16 50 36° 7.2 W/3000K GU5.3

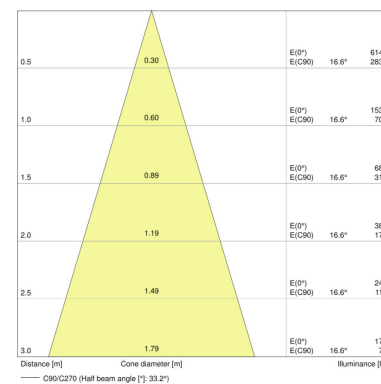

P MR16 50 36° 7.2 W/4000K GU5.3

EQUIPMENT / ACCESSORIES

- Equipped with high-power LEDs

APPLICATION ADVICE

For more detailed application information and graphics please see product datasheet.

LOGISTICAL DATA

Product code	Packaging unit (Pieces/Unit)	Dimensions (length x width x height)	Gross weight	Volume
4052899958449	Shipping carton box 10	257 mm x 110 mm x 70 mm	472.00 g	1.98 dm ³
4058075815407	Shipping carton box 10	257 mm x 110 mm x 70 mm	472.00 g	1.98 dm ³
4052899958432	Shipping carton box 10	257 mm x 110 mm x 70 mm	467.00 g	1.98 dm ³
4052899958470	Shipping carton box 10	257 mm x 110 mm x 70 mm	471.00 g	1.98 dm ³
4058075815520	Shipping carton box 10	257 mm x 110 mm x 70 mm	470.00 g	1.98 dm ³
4052899958487	Shipping carton box 10	257 mm x 110 mm x 70 mm	475.00 g	1.98 dm ³
4052899958517	Shipping carton box 10	255 mm x 107 mm x 72 mm	761.00 g	1.96 dm ³
4058075815582	Shipping carton box 10	255 mm x 107 mm x 72 mm	739.00 g	1.96 dm ³
4052899958524	Shipping carton box 10	255 mm x 107 mm x 72 mm	745.00 g	1.96 dm ³

The mentioned product code describes the smallest quantity unit which can be ordered. One shipping unit can contain one or more single products. When placing an order, for the quantity please enter single or multiples of a shipping unit.

REFERENCES / LINKS

For further products and actual information concerning LED lamps see

- ▶ www.ledvance.com/ledlamps

For Guarantee see

- ▶ www.ledvance.com/guarantee

Further information see

- ▶ www.ledvance.com/low-voltage-ledlamps

DISCLAIMER

Subject to change without notice. Errors and omission excepted. Always make sure to use the most recent release.