

Arteor™ Double pole switches

Cat. no(s): 5 720 13/40/46/48 - 5 721 78/79/82/83/84/85/92/93
 5 725 13/40/46/48 - 5 730 30/31/65/75/77
 5 731 30/31/38/65/75/77

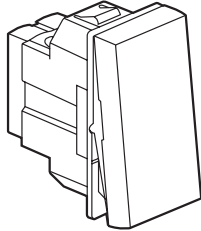

5 720 13 - 5 721 82/83 - 5 725 13

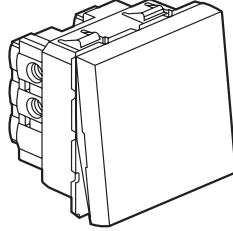

5 720 40/46 - 5 721 78/79/84/85 - 5 725 40/46

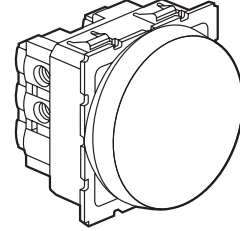









5 730 65/75 - 5 731 38/65/75

1. USE

General lighting control mechanisms.

2. RANGE

	Designation	Finishes				No. of modules	Connection method	Characteristics
		White	Magnesium	Soft alu	Champagne			
	Double pole switch one way (square)	5 720 13	5 725 13	5 721 82	5 721 83	1	with screws	20 AX - 250 VAC
	Double pole switch one way (square)	5 720 40	5 725 40	5 721 78	5 721 79	2	with screws	6/10 AX - 250 VAC
	Double pole switch one way (square)	5 720 46	5 725 46	5 721 84	5 721 85	2	with screws	20 AX - 250 VAC
	Double pole switch two way (square)	5 720 48	5 725 48	5 721 92	5 721 93	2	with screws	20 AX - 250 VAC
	Double pole switch one way (round left)	5 730 30	5 731 30	-	-	1	with screws	20 AX - 250 VAC
	Double pole switch one way (round right)	5 730 31	5 731 31	-	-	1	with screws	20 AX - 250 VAC
	Double pole switch one way (round)	5 730 65	5 731 65	5 731 38	-	2	with screws	6/10 AX - 250 VAC
	Double pole switch one way (round)	5 730 75	5 731 75	-	-	2	with screws	20 AX - 250 VAC
	Double pole switch two way (round)	5 730 77	5 731 77	-	-	2	with screws	20 AX - 250 VAC

3. PREPARATION

The mechanisms can be flush-mounted or surface-mounted

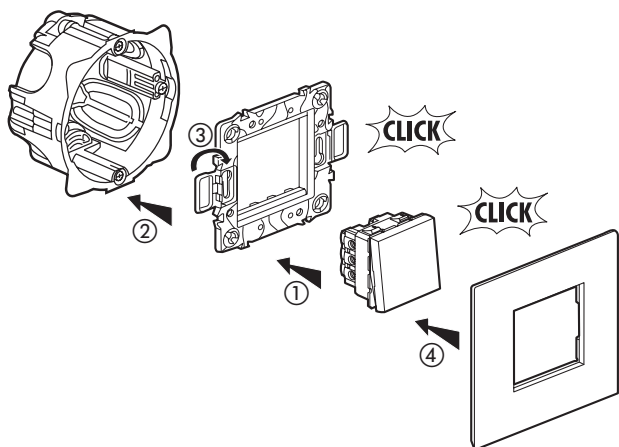

4. OVERALL DIMENSIONS

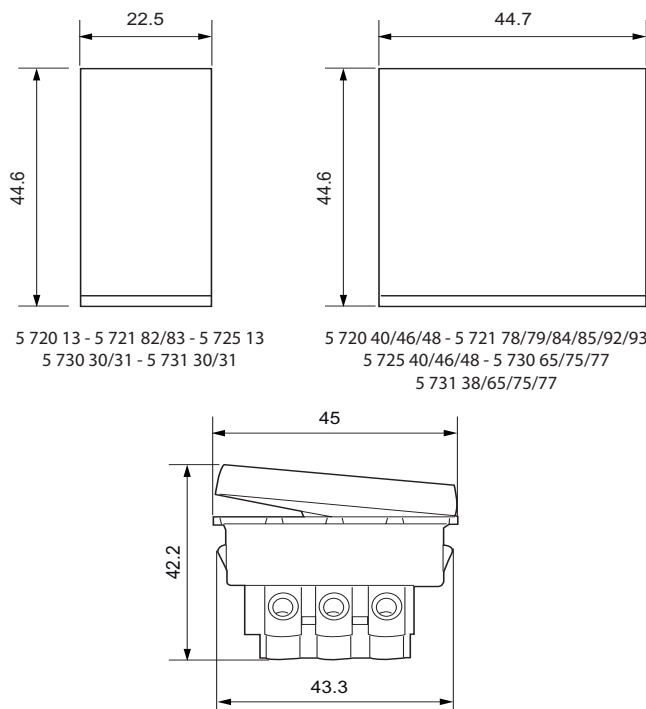

5. CONNECTION

Terminals: with screws
Capacity and stripping:

	Capacity			Stripping
5 720 13 - 5 721 82/83 5 725 13 - 5 730 30/31 5 731 30/31	4 x 2.5 mm ²	1 x 4 mm ²	1 x 6 mm ²	8 mm
5 720 40 - 5 721 78/79 5 725 40 5 730 65 - 5 731 38/65	2 x 2.5 mm ²	1 x 4 mm ²	-	10 mm
5 720 46/48 5 721 84/85/92/93 5 725 46/48 5 730 75/77 5 731 75/77	4 x 2.5 mm ²	2 x 4 mm ²	1 x 6 mm ²	

Screwdriver: 4 mm flat-blade up to 5.5 mm

6. OPERATION

Switching mechanism.

7. TECHNICAL CHARACTERISTICS

■ 7.1 Mechanical characteristics

Impact tests: IK 04
Protection by solid bodies / liquids: IP 40 (mounted)
IP 20 (alone)

■ 7.2 Material characteristics

Rocker: Polycarbonate
Base: Polycarbonate
Basket: Polypropylene

■ 7.3 Electrical characteristics

Voltage: 250 VAC

Current:	5 720 40 - 5 721 78/79 - 5 725 40	6/10 AX
	5 730 65 - 5 731 38/65	
	Other	20 AX

Self-extinguishing: 650° C/30 s

■ 7.4 Climatic characteristics

Storage temperature: - 10° C to + 70° C
Operating temperatures: - 5° C to + 50° C

8. CLEANING

Surface cleaning with a cloth
Do not use: acetone, tar remover, trichloroethylene

Resistance to the following cleaning agents: Hexane (EN-60669-1), Methylated spirits, Soapy water, diluted ammonia, diluted pure bleach 10%, Glass cleaning substance, Pre-impregnated wipes.

Caution: Always test before using other special cleaning products.

9. STANDARDS AND APPROVALS

Compliance with installation and manufacturing standards.
Refer to e-catalogue.