

IP room controller

Cat. No(s): 0 484 12

DALI

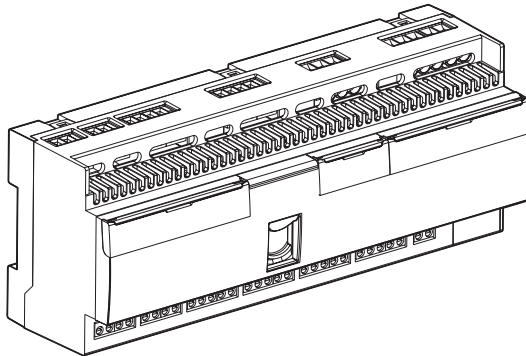

CONTENTS

Page

1. Introduction.....	1
2. Technical characteristics.....	1
3. Wiring	3
4. Parameter setting.....	6
5. Care.....	6
6. Standards	6

BACnet® is a registered trademark of ASHRAE.

1. Introduction

The IP modular controller Cat. No. 0 484 12 has been specially designed for controlling hotel rooms and meeting rooms. It can be powered via a PoE injector on the IP network or by an external power supply.

It comprises:

- 16 configurable auxiliary inputs for issuing commands such as ON/OFF, Dim +/-, scenes, up/down/stop for roller blinds via switches, pushbuttons and other volt-free contact devices.
- 16 configurable binary outputs for controlling the lighting (2 blocks of 4 relays: 4.3 A max to be distributed between the blocks), the shutters (2 blocks of 2 relays: 2.1 A max to be distributed between the blocks), and the power sockets (2 blocks of 2 relays: 16 A max to be distributed between the blocks).
- One DALI dimming output:
- In broadcast mode
- In group mode (16 groups max.)

The DALI output can supply up to 20 ballasts (max. bus consumption 40 mA) or up to 64 ballasts with the addition of an external DALI power supply.

Each output can be part of the various scenarios associated with conditional functions such as volt-free contacts, level of light or time programming. Automatic presence management (Virtual Keycard) can determine whether the room is occupied by combining data from the motion sensors and the door contact.

An SCS BUS connection can link the SCS actuators and control units to a customised interface, thus linking dimmers with various loads and controlling temperature regulation.

The parameters are set in the software via the IP network.

The self-configured outputs are supervised using the IP Bacnet protocol.

2. Technical characteristics

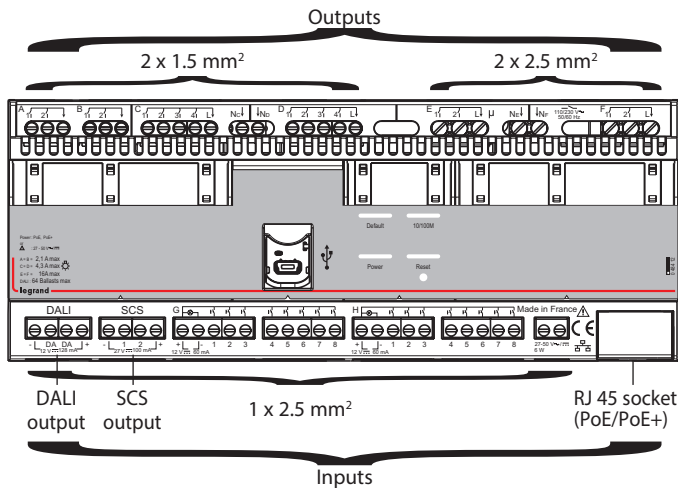

Neutral terminals needed for:
- Synchronisation with the mains power supply

2. Technical characteristics (continued)

Device power supply	• RJ 45 (PoE/PoE+ class 0) or • Screw terminal block (27-50 V~ / V=)
Number of load terminals	16 outputs { A - B: 2.1 A blocks C - D: 4.3 A blocks E - F: 16 A blocks
Number of auxiliary input terminals	16 inputs (G - H: 2 blocks of 8 inputs)
Capacity of load terminals	2 x 1.5 mm ² (A to D) 2 x 2.5 mm ² (E to F)
Capacity of SCS terminals	1 x 2.5 mm ²
Capacity of DALI load terminals	1 x 2.5 mm ²
Capacity of auxiliary input terminals	1 x 2.5 mm ²
Contact type	Bistable and monostable relay
RJ 45	Auto-MDI/MDI-X Full duplex
Location category	Indoors
Degree of protection	
Penetration of solid bodies and liquids	IP 20 (installation in an enclosure)
Impact resistance	IK 04
Number of modules	12
Operating temperature	-5°C to +45°C
Storage temperature	-20°C to +70°C
No-load power consumption	< 1 W
Weight	387 g

Dimensions

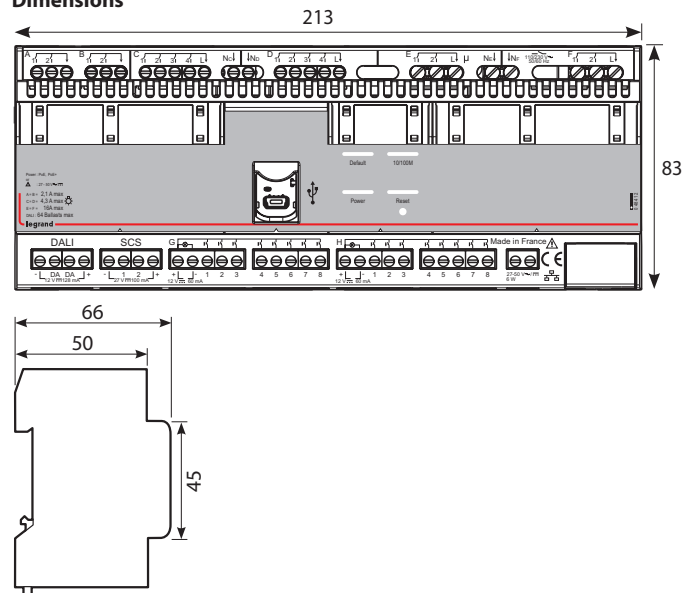

2. Technical characteristics (continued)

	1		2		3		4		5		6		7		8		9				
Outputs A - B	230 V~	80 VA	0.3 A		250 VA	1.1 A	250 VA	1.1 A	2 (2 x 36) W		0.8 A	80 VA	0.3 A	80 VA	0.3 A	500 W	2.1 A	250 VA	1.1 A	250 VA	1.1 A
	110 V~	40 VA	0.3 A		125 VA	1.1 A	125 VA	1.1 A	1 (2 x 36) W		0.8 A	40 VA	0.3 A	40 VA	0.3 A	250 W	2.1 A	125 VA	1.1 A	125 VA	1.1 A
	12 - 48 V~/V=	4 - 15 VA	0.3 A																13 - 52 VA	1.1 A	13 - 52 VA
Outputs C - D	230 V~	160 VA	0.7 A		500 VA	2.1 A	500 VA	2.1 A	4 (2 x 36) W		1.7 A	160 VA	0.7 A	160 VA	0.7 A	1000 W	4.3 A	500 VA	2.1 A	500 VA	2.1 A
	110 V~	80 VA	0.7 A		250 VA	2.1 A	250 VA	2.1 A	2 (2 x 36) W		1.7 A	80 VA	0.7 A	80 VA	0.7 A	500 W	4.3 A	250 VA	2.1 A	250 VA	2.1 A
Outputs E - F	230 V~	500 VA	2.1 A		1000 VA	4.3 A	1000 VA	4.3 A	10 (2 x 36) W		4.3 A	500 VA	2.1 A	500 VA	2.1 A	3680 W	16 A	500 VA	2.1 A	500 VA	2.1 A
	110 V~	250 VA	2.1 A		500 VA	4.3 A	500 VA	4.3 A	5 (2 x 36) W		4.3 A	250 VA	2.1 A	250 VA	2.1 A	1760 W	16 A	250 VA	2.1 A	250 VA	2.1 A

- 1 LED bulbs
- 2 ELV halogen, compact fluorescent and fluorescent bulbs with separate electronic ballast
- 3 ELV halogen, compact fluorescent and fluorescent bulbs with separate ferromagnetic ballast
- 4 Fluorescent tubes
- 5 Compact fluorescent bulbs with built-in electronic ballast
- 6 Compact fluorescent bulbs with built-in ferromagnetic ballast
- 7 Halogen bulbs
- 8 Motors
- 9 Contactors

Power supply unit

The device must be powered by an external power supply. Accepted voltage range: 27 to 50 V ~/~, 6 W min.

Power outputs

- Block A and B (2 blocks of 2 relays: 2.1 A max to be distributed between the blocks).
Used to perform roller blind control functions, or to switch mutually-exclusive indicators (for example: Do not disturb/Please clean up).
- Block C and D (2 blocks of 4 relays: 4.3 A max to be distributed between the blocks).
Used to control 4 independent loads per block.
- Block E and F (2 blocks of 2 relays: 16 A max to be distributed between the blocks).
Used to control 2 independent loads per block.

DALI output

Used to control 64 DALI ballasts in Broadcast mode. No need to pair the device with the DALI output.
A power supply for the DALI BUS is integrated in the device. I_{max} 40 mA/12 V= (20 ballasts max). If I is greater than 40 mA, use an external power supply (remove the jumpers from the DALI terminals).

SCS output

This block has a power supply output (+, -) which can be used to power the bus if necessary and the SCS communication BUS (1, 2).
The internal power supply can provide a maximum of 100 mA on the bus.
This self-powered option is achieved by bridging.
If it is necessary to connect more than 100 mA of peripheral equipment, an external SCS power supply can be added to the bus. In this case you must remove the internal power supply.
On the SCS BUS, the control units, actuators, dimmers, thermostats, detectors can be configured and linked to the scenarios using the configuration software.

Control unit inputs

- Block G and H.
The device has 2 blocks, each of which has a power supply output (12 V=) and 8 auxiliary inputs. The inputs can take switches or pushbuttons for issuing commands such as ON/OFF, dimming, up/down, scenarios whose parameters are set using the configuration software. The power supply provides low-level lighting for the control units (pilot light).

IP unit

The device has a LAN connection for communication and a Power Over Ethernet connection to supply it with power.
The device can operate at 10 or 100 Mbps. The data rate is 10 kB/s max. per device in Unicast (multiple reading of 50 variables = 2.1 kB/s).

3. Wiring

• Single phase

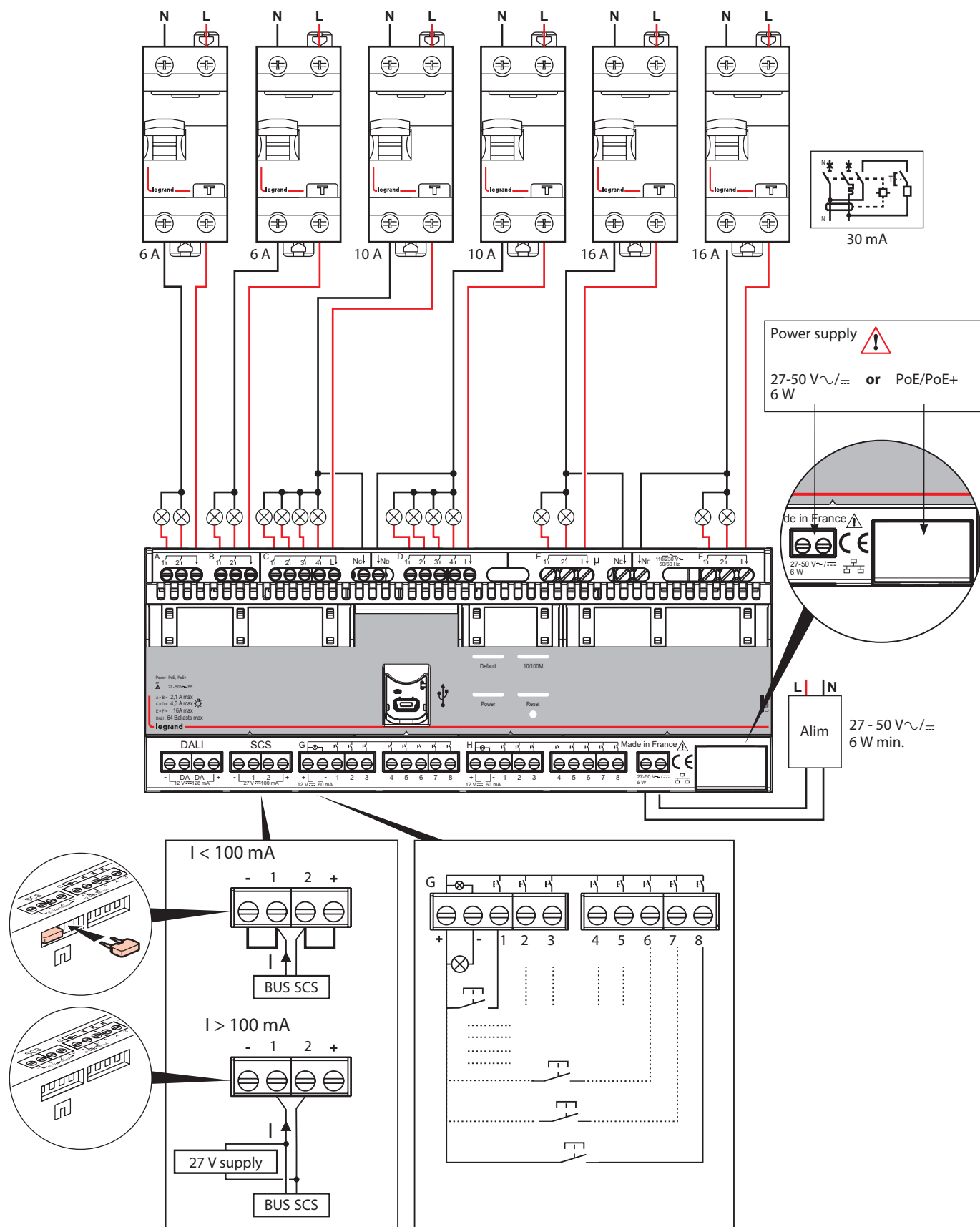

IP room controller

Cat. No(s): 0 484 12

• Single phase (continued)

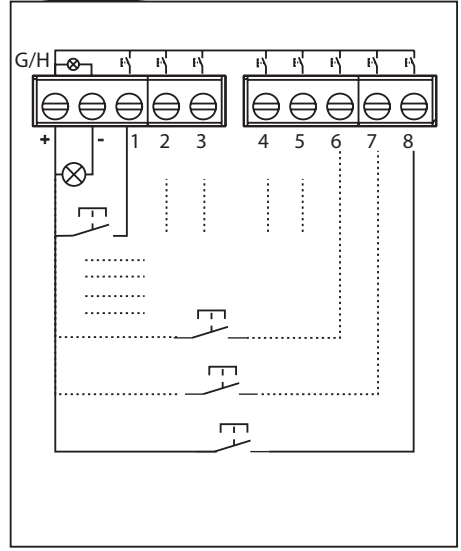
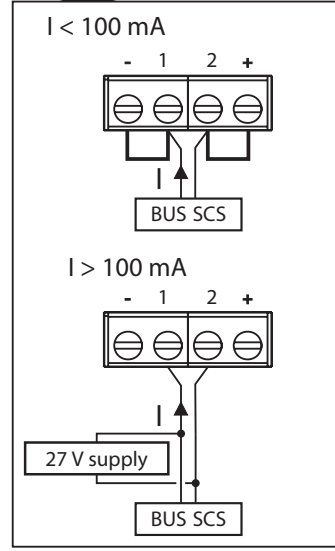
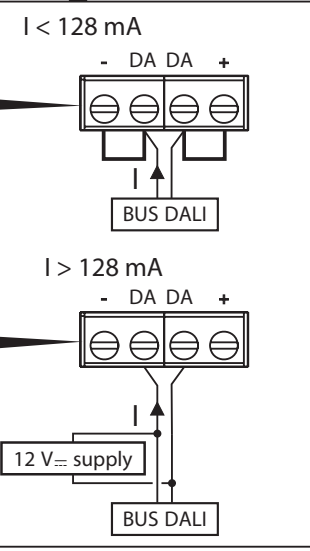
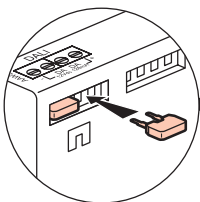
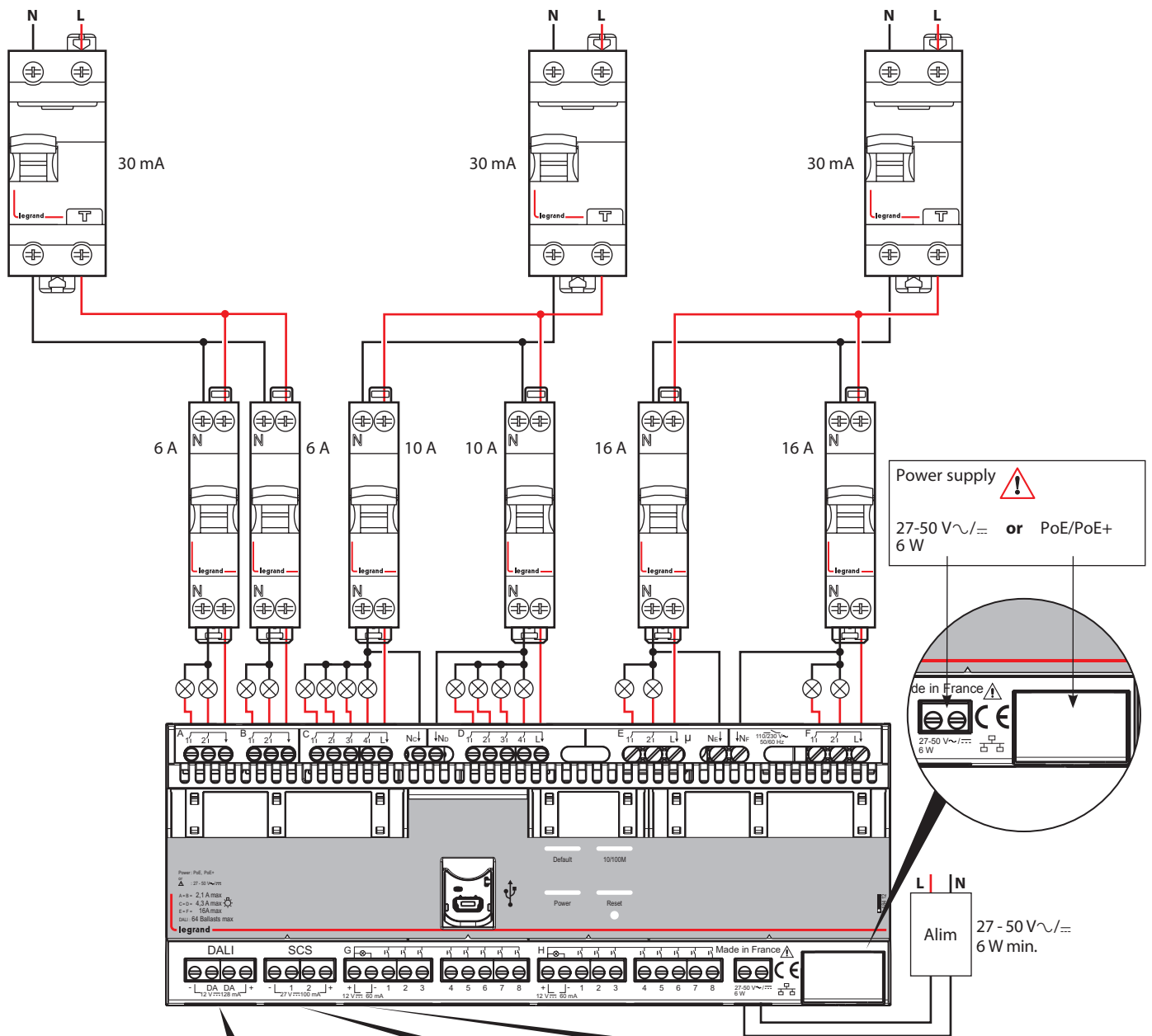

IP room controller

Cat. No(s): 0 484 12

• Three-phase

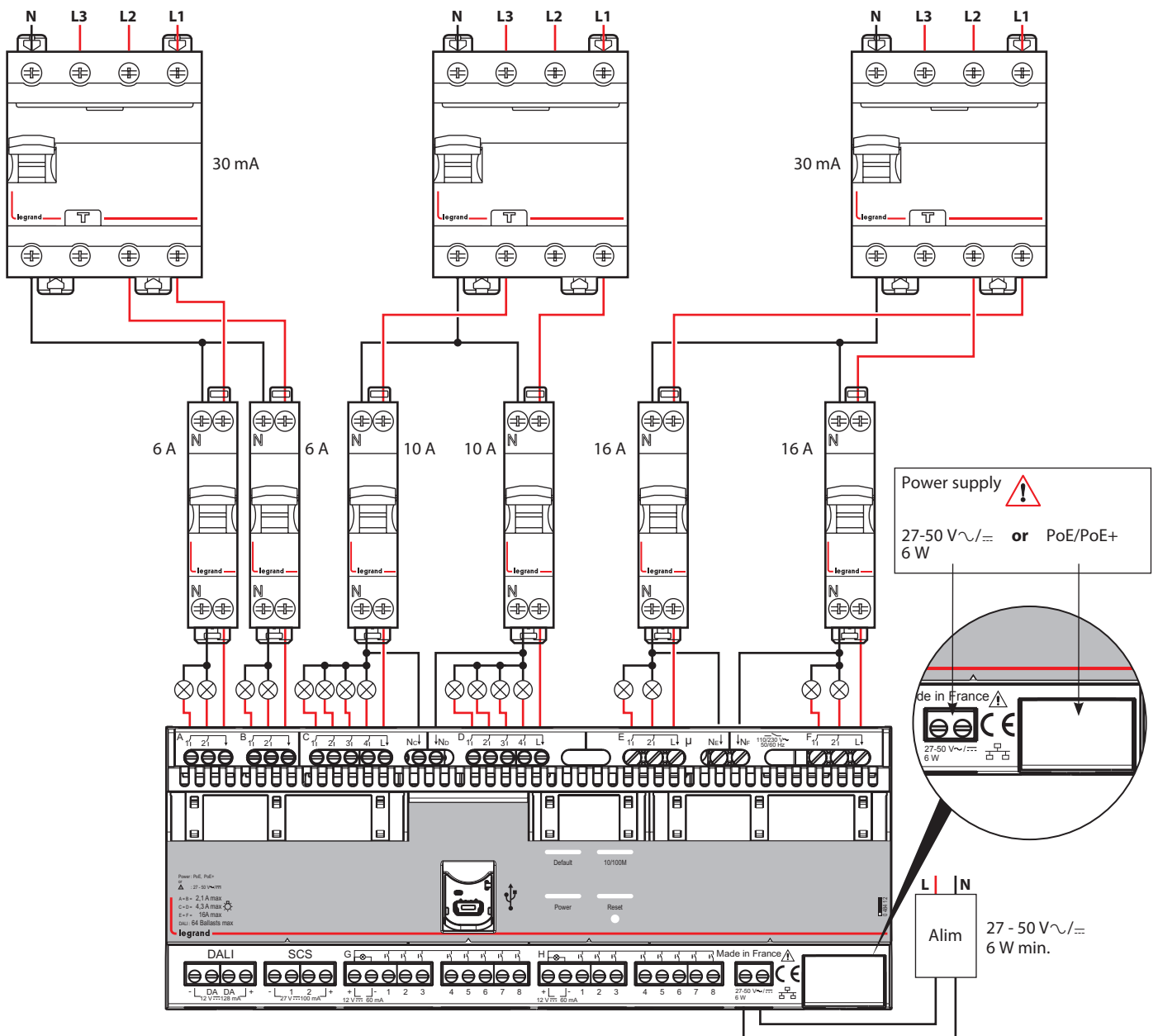

4. Parameter setting

The device parameters are set using a special software tool: HRCS (Hotel Room Controller Software).

 www.legrandoc.com

Factory configuration:

Input	G1	G2	G3	G4	G5	G6	G7	G8
Output	A1	A2	B1	B2	C1	C2	C3	C4
Action	UP/ STOP	DOWN/ STOP	UP/ STOP	DOWN/ STOP	ON/OFF	ON/OFF	ON/OFF	ON/OFF

Input	H1	H2	H3	H4	H5	H6	H7	H8
Output	D1	D2	D3	D4	E1	E2	F1	F2/DALI
Action	ON/OFF	ON/OFF	ON/OFF	ON/OFF	ON/OFF	ON/OFF	ON/OFF	ON/OFF

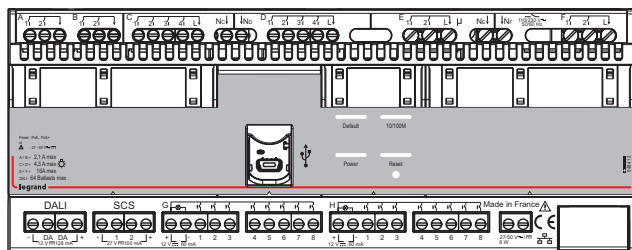

Power LED

- On: The device is powered and has an IP address.
- Flashing slowly: The device is powered but does not have a valid IP address.
- Off: The device is not powered.

10/100 M LED

- Orange LED
 - Off: The Ethernet cable is not connected.
 - On: The Ethernet cable is connected.
 - Flashing: Activity indicator
- Green LED
 - Off: 10 Mbps
 - On: 100 Mbps

USB (do not use)

- Reserved for future functions.

"Fault" LED

- On: Indicates a fault
- Off: No faults

Reset LED

- Flashing slowly: Configuration status (following a short press of the Reset button)
- Flashing quickly: Reset in progress (following a 10 s press of the Reset button)
- Off: Normal operation

Reset button

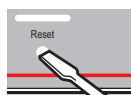

- Short press: The Reset LED flashes slowly and the device sends a BACnet message: "_I_AM".

- Long press: The device resets its IP configuration after a short press followed by a long press lasting 10 s.

5. Care

Do not use: acetone, tar-removing cleaning agents or trichloroethylene.
Resistant to the following products: - Hexane
- Methylated spirit
- Soapy water
- Diluted ammonia
- Bleach diluted to 10%
- Window-cleaning products.

Caution: Always test before using other special cleaning products.

6. Standards

CE-compliant

Product standards: IEC 60 669-2-1

Environmental standards:

- European directive 2002/96/EC:

WEEE (Waste Electrical and Electronic Equipment).

- European Directive 2002/95/EC:

RoHS (Restriction of Hazardous Substances).

- Regulations: ERP (public buildings)
ERT (workplace buildings)
IGH (high-rise buildings)

- PoE standard: IEEE 802.3 AF/AT