

Viking 3 - Screw connection Disconnect terminal blocks

Catalogue numbers: 0 371 80/81/82/83/84/85/86/87
0 375 15/16/17/18

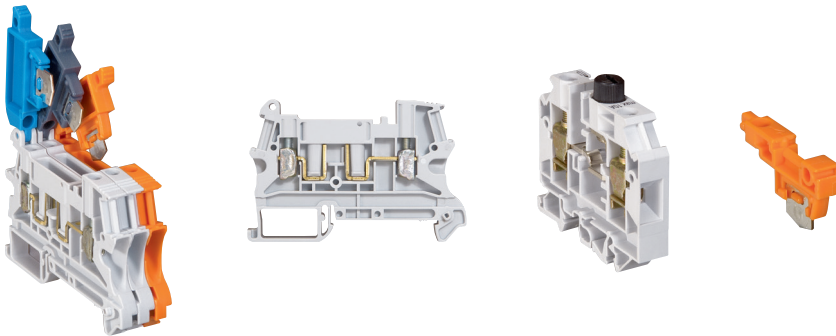

CONTENTS

1. General features	1
2. Range	2
3. Standards	2
4. Technical features.....	3
5. Dimensions.....	4
6. Accessories.....	4

1. GENERAL FEATURES

Viking 3 terminal blocks provide the electrical connection between two flexible or rigid copper conductors.

Disconnect blocks enable an electrical circuit to be opened temporarily without disconnecting the conductors.

There are three types of disconnect block in the Viking 3 range, which are opened:

- By handle lever
- By mini lever
- Using the associated protection device (for example, removal of fuse)

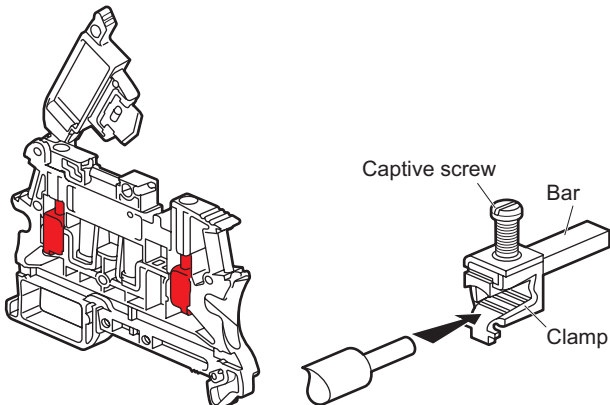

- Insulated polyamide body
- Tin-coated brass bars providing perfect contact quality
- Zinc-plated steel screws and clamps providing excellent mechanical strength

A joining pin on the insulated body holds 6 mm pitch Viking 3 disconnect blocks together, making them easier to handle and helping to ensure they are perfectly aligned on the rail. However it is still possible to fit/remove a block without having to remove the adjacent blocks.

The ergonomic shape of the insertion system makes it easy to insert conductors.

Using Starfix ferrules provides an equipotential link for all the strands of a flexible conductor.

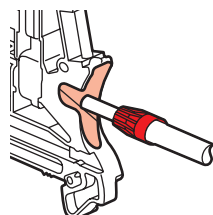

1. GENERAL FEATURES (continued)

The base of the blocks enables them to be fitted on 3 types of symmetrical rail.

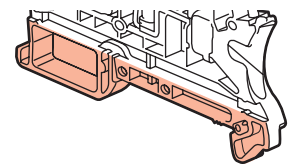

	EN 60715		
	-	1	2.2
Thickness (mm)	1.5	1	2.2
Depth (mm)	15	7.5	15

The 12 mm pitch blocks with fuse and screw-in plug can also be fitted on asymmetrical rails □.

The blocks have two marking areas.

The 6 mm pitch disconnect blocks have two areas for screw-free automatic insertion equipotential bridging combs. (see section 6.6)

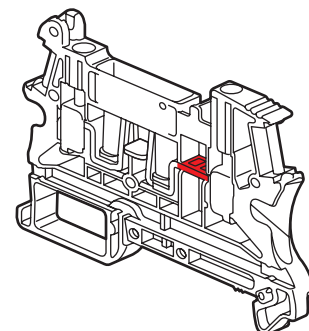

The colours are linked to the circuit type:

- Grey block for standard circuits
- Grey block with blue lever for neutral conductors
- Orange block for circuits not broken by the master isolating device

Viking 3 - Screw connection Disconnect terminal blocks

Catalogue numbers: 0 371 80/81/82/83/84/85/86/87
0 375 15/16/17/18

2. RANGE

Viking 3 disconnect blocks have 1 connection - 1 input/1 output.

Nominal cross-section according to IEC EN 60947-7-1/7-3.

Cat. Nos	Nominal cross-section (mm ²)	Pitch (mm)
0 371 80/81/82/83/84/85/86	2.5	6
0 371 87	10	12

■ 2.1 Open block, to be equipped, Cat. No. 0 371 80

The open block can take a DIN 72581-3/ISO 8820 blade-type automotive fuse or a miniature circuit-breaker (ELV only).

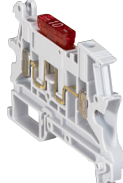

Block Cat. No. 0 371 80 with blade-type automotive fuse

The open block can also be equipped with handle levers Cat. Nos 0 375 15/16/17 and mini lever Cat. No. 0 375 18 (see section 6.1)



Cat. No. 0 375 15 Cat. No. 0 375 16 Cat. No. 0 375 17 Cat. No. 0 375 18
} Handle levers (open manually)
} Mini lever (open with tool)

The open block equipped with these levers is equivalent to disconnect blocks Cat. Nos 0 371 81/82/83/84.

■ 2.2 Block for 5 x 20 fuse cartridge with handle lever, Cat. No. 0 371 81

Grey block, dark grey handle lever

The handle lever on block Cat. No. 0 371 81 is designed to take a 5x20 fuse cartridge.

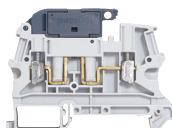

The block can be equipped with a blown fuse indicator Cat. Nos 0 375 24/25 (see section 6.2)

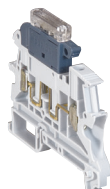

■ 2.3 Block for neutral circuits with handle lever, Cat. No. 0 371 82

Grey block, blue handle lever

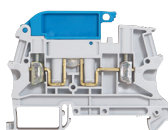

2. RANGE (continued)

■ 2.4 Block for standard circuits with handle lever, Cat. No. 0 371 83

Grey block, dark grey handle lever

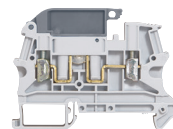

■ 2.5 Block for standard circuits with mini lever, Cat. No. 0 371 84

Grey block, orange mini lever

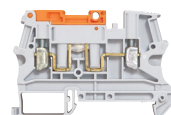

■ 2.6 Block for circuits not broken with handle lever, Cat. No. 0 371 85

Orange block, orange handle lever

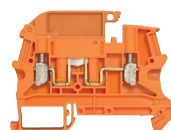

■ 2.7 Block for circuits not broken with mini lever, Cat. No. 0 371 86

Orange block, orange mini lever

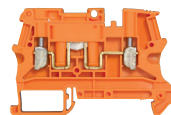

■ 2.8 Blocks for fuse cartridge with screw-in plug Cat. No. 0 371 87 (5 x 20)

Grey block, black plug

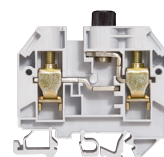

3. STANDARDS

- IEC EN 60947-1:
Low-voltage switchgear and controlgear
- IEC EN 60947-7-1:
Low-voltage switchgear and controlgear - Part 7-1: Ancillary equipment - Terminal blocks for copper conductors
- IEC EN 60947-7-3:
Low-voltage switchgear and controlgear - Part 7-3: Ancillary equipment - Safety requirements for fuse terminal blocks
- CSA C22-2 No. 158:
Terminal blocks
- UL 1059:
Terminal blocks
- IEC 60364-5-52:
Electrical installations of buildings - Part 5-52: Selection and erection of electrical equipment - Wiring systems
- IEC EN 60664-1:
Insulation coordination for equipment within low-voltage systems (networks) - Part 1: Principles, requirements and tests
- UL 94:
Tests for flammability of plastic materials for parts in devices and appliances
- IEC EN 60529:
Degrees of protection provided by enclosures (IP code)

Viking 3 - Screw connection Disconnect terminal blocks

Catalogue numbers: 0 371 80/81/82/83/84/85/86/87
0 375 15/16/17/18

4. TECHNICAL FEATURES

4.1 Type of conductor

Conductors connected must be flexible or rigid copper:

- Class 1, rigid core
- Class 2, stranded rigid core
- Class 5, flexible core
- Flexible core with ferrule

4.2 Connection cross-section

According to IEC EN 60947-7-1/7-3

Cat. Nos	Nominal cross-section (mm ²)	Pitch (mm)	Capacity (mm ²)	
			Rigid conductor	Flexible conductor with or without ferrule
0 371 80/81/82/83/84/85/86	2.5	6	0.25 to 2.5	0.25 to 2.5
0 371 87	10	12	0.25 to 10	0.25 to 10

Viking 3 terminal blocks take the dimensions of the ferrule into account for flexible conductors (Starfix double ferrules, see section 4.9).

According to CSA no. 22-2 no. 158 and UL 1059

Cat. Nos	Nominal cross-section (AWG)	Pitch (mm)
0 371 80/81/82/83/84/85/86	12	6
0 371 87	6	12

4.3 Conductor stripping length

Cat. Nos	Pitch (mm)	Length (mm)
0 371 80/81/82/83/84/85/86	6	6 to 8
0 371 87	12	11 to 14

4.4 Tightening torque

Cat. Nos.	Screwdriver ⁽¹⁾		UL (Nm)
	Torque (Nm)	Ø Blade (mm)	
0 371 80/81/82/83/84/85/86	1,4	4	0,79
0 371 87	4	6,5	2

(1) For slotted head screw

The connection screws remain accessible when the handle lever or mini lever is closed.

4.5 Insulation voltage and current

The AC and DC performance of Viking 3 blocks is identical.

Cat. Nos	Voltage (V)			Current (A)		
	IEC	CSA	UL	IEC	CSA	UL
0 371 80/82/83/84/85/86	500	300	300	15	15	15
0 371 80 + blade-type automotive fuse	ELV			10	-	-
0 371 81 or 0 371 80 + 0 375 15	250	250	250	6.3	6.3	6.3
0 371 87	250	250	250	10	10	10

IEC EN 60947-7-1/7-3, CSA No. 22-2 No. 158, UL 1059

Insulation voltage of shunted blocks: see section 6.6

4. TECHNICAL FEATURES (continued)

4.6 Power according to IEC EN 60947-7-3

Cat. Nos	Short-circuit		Short-circuit + overload	
	Separate blocks	Assembled blocks	Separate blocks	Assembled blocks
0 371 81 or 0 371 80 + 0 375 15⁽¹⁾	4 W/6.3 A	1.6 W/6.3 A	1.6 W/6.3 A	-
	Pvk = 4.75 W	Pvk = 2 W	Pv = 1.65 W	-
0 371 87	4 W	2.5 W	1.6 W	-
	Pvk = 5 W	Pvk = 2.7 W	Pv = 1.8 W	-

(1): with or without blown fuse indicator Cat. No. 0 375 25.

4.7 Utilisation category and protection class

Utilisation category according to IEC EN 60947-1 (6 mm pitch blocks):

- Material group I
- Comparative tracking index (CTI): ≥ 600 V
- Overvoltage category III
- Pollution degree 3

Protection class according to IEC EN 60529:

- 6 mm pitch blocks: IPXXB
- 12 mm pitch blocks: IPXXB with plug fitted. To limit the risks with the plug removed, the wiring direction indicated on the block  must be followed.

Note: the last block in a terminal block must be fitted with an end cap.

4.8 Tap-off

It is possible to connect 2 conductors at a single connection point under the following conditions:

- Do not mix flexible and rigid cores
- Do not mix 2 rigid core conductors with different cross-sections

Combinations of 2 conductors per connection point are permitted as shown in the following table (mm²):

	Class 1 Solid rigid core	Class 2 Stranded rigid core	Class 5 Flexible core	Flexible core with single ferrule	Class 5 Flexible core (different cross-sections)
	Blocks 6 mm pitch	2 x 0.5 2 x 0.75 2 x 1 2 x 1.5		2 x 0.5 2 x 0.75 2 x 1 2 x 1.5	2 x 0.5

4.9 Compatibility with Starfix double ferrules

	Double ferrule (mm ²)			
	Cat. No. 0 376 87 2 x 0.75	Cat. No. 0 376 88 2 x 1	Cat. No. 0 376 89 2 x 1.5	Cat. No. 0 376 90 2 x 2.5
6 mm pitch blocks	✓	✓	✓	✓
12 mm pitch blocks	✓	✓	✓	✓

Viking 3 - Screw connection Disconnect terminal blocks

Catalogue numbers: 0 371 80/81/82/83/84/85/86/87
0 375 15/16/17/18

4. TECHNICAL FEATURES (continued)

4.10 Usage conditions

Ambient temperature	-5°C/+40°C Average 35°C max. over 1124 hours
Relative humidity	90% max. at 20°C 50% max. at 40°C
Altitude	2000 m max.
Pollution degree	3 according to IEC EN 60664-1 and IEC EN 60947-1

Transport temperature: -25°C/+55°C (+70°C for 24 hours)
Polyamide -30 to +100°C

4.11 Fire resistance

- Polyamide V2 according to UL94, halogen-free
- Glow wire: 960°C according to IEC EN 60695-2-11
- Corrosiveness of fumes: 5% according to NF C 20453
- Limiting oxygen index (LOI): 27 according to EN ISO 4589-2

Public buildings

The 960°C glow wire resistance according to standard IEC EN 60695-2-11 enables Viking 3 terminal blocks to be used in public buildings, including in safety circuits.

5. DIMENSIONS

The 6 mm pitch disconnect blocks enable attractive terminal blocks to be created, as:

- The height of the blocks with mini lever is identical to that of the 5 to 10 mm pitch blocks with 1 connection in the rest of the Viking 3 screw connection range
- The heights of the blocks are identical irrespective of the type of lever

Cat. No. 0 371 80:

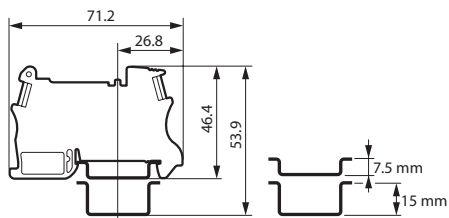

Cat. No. 0 371 81/82/83/85:

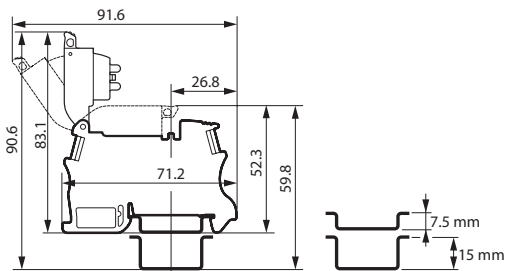

Cat. No. 0 371 84/86:

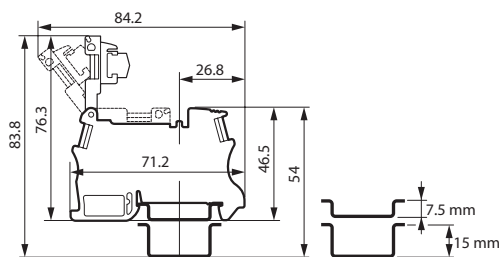

5. DIMENSIONS (continued)

Cat. No. 0 371 87:

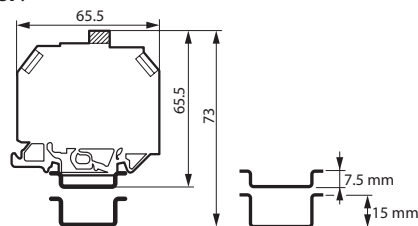

6. ACCESSORIES

6.1 Handle levers/mini lever

A handle lever can be used for manual opening.

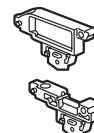

A tool is required for the mini lever.

Cat. Nos	Type
0 375 15	Handle lever for 5 x 20 fuse cartridge - dark grey
0 375 16	Handle lever for neutral - blue
0 375 17	Handle lever - dark grey
0 375 18	Mini lever - orange

The open block Cat. No. 0 371 80 equipped with these accessories is equivalent to disconnect blocks Cat. Nos 0 371 81/82/83/84:

Equivalence table	
Open block Cat. No. 0 371 80	+ Cat. No. 0 375 15 = block Cat. No. 0 371 81
	+ Cat. No. 0 375 16 = block Cat. No. 0 371 82
	+ Cat. No. 0 375 17 = block Cat. No. 0 371 83
	+ Cat. No. 0 375 18 = block Cat. No. 0 371 84

Polyamide V2 acc. to UL94, halogen-free, 960°C acc. to IEC EN 60695-2-11

LEGRAND ADVANTAGE

The handle levers and mini lever are compatible with the Viking 3 spring connection range (open block Cat. No. 0 372 80).

6.2 Blown fuse indicators



The handle lever on the block with 5x20 fuse cartridge Cat. No. 0 371 81 (or handle lever Cat. No. 0 375 15) can take a snap-on blown fuse indicator (attached with power off).

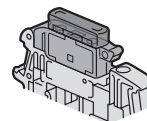

Cat. Nos	Type	Appearance
0 375 24	12/24/48 V = ~	bluish
0 375 25	110/250 V ~	colourless

Indicators Cat. Nos 0 375 24/25 can also be used with the Viking 3 spring connection range.

6.3 Joining rods

These treated steel rods are used to join several disconnect block handle levers or mini levers together (for example for simultaneous opening of the phase and neutral).

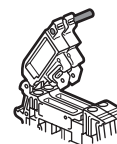

Cat. Nos	Number of blocks
0 375 21	for 2 blocks
0 375 22	for 3 blocks

Viking 3 - Screw connection

Disconnect terminal blocks

Catalogue numbers: 0 371 80/81/82/83/84/85/86/87
0 375 15/16/17/18

6. ACCESSORIES (continued)

6.4 End caps

Polyamide, dark grey, halogen-free
V2 according to UL 94
960°C according to IEC EN 60695-2-11.

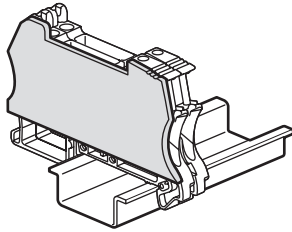

Cat. Nos	For blocks	Thickness (mm)
0 375 55	6 mm pitch	2
0 375 56	12 pitch - screw-in plug	1.4

6.5 Separation and insulation divider

Polyamide, dark grey, halogen-free
V2 according to UL 94
960°C according to IEC EN 60695-2-11

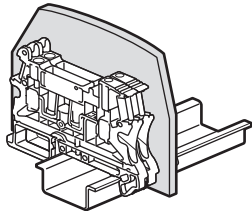

Cat. Nos	For blocks	Thickness (mm)
0 375 62	6 mm pitch	2.5

6.6 Equipotential bridging combs

- Front fitting, automatic insertion, screw-free for faster fitting
- Insulated and separable
- For consecutive or alternating connection
- Tin-plated copper and coloured polyamide

Cat. Nos	Colour	Capacity
0 375 03	Blue	10 blocks - 6 mm pitch
0 375 04	Red	10 blocks - 6 mm pitch
0 375 05	Red	2 blocks - 6 mm pitch

The 6 mm pitch disconnect blocks have 2 areas for equipotential bridging combs.

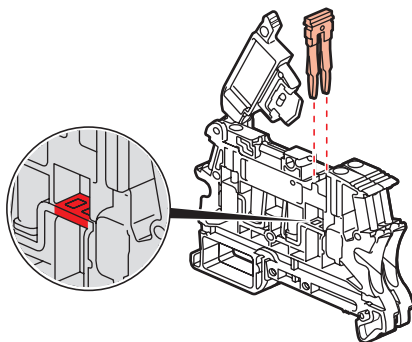

The combs remain visible when the handle lever is closed, and remain accessible when the mini lever is closed.

6. ACCESSORIES (continued)

LEGRAND ADVANTAGE

Up to 8 mm pitch, the combs are the same for the Viking 3 screw connection and spring connection ranges.

The 2 areas enable tapping off for a continuous equipotential link of more than 10 blocks.

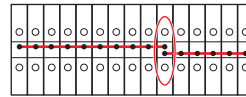

The insulated combs maintain the insulation voltages of the disconnect terminal blocks.

When there are 2 groups of shunted blocks side by side:

- A separation and insulation divider must be inserted between the 2 groups to maintain the initial insulation voltage:

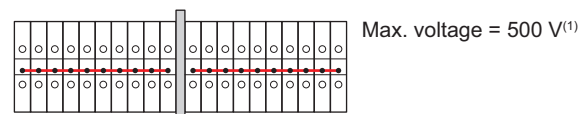

- (1) 0 371 81,
0 371 80 +
0 375 15: 250 V max.

Separation and insulation divider

- Otherwise, the voltage will be derated:

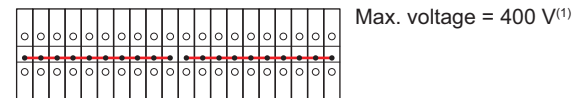

- (1) 0 371 81, 0 371 80 + 0 375 15: 250 V max.

If the comb is cut to length, it is essential to use a separation and insulation divider to maintain the insulation voltage:

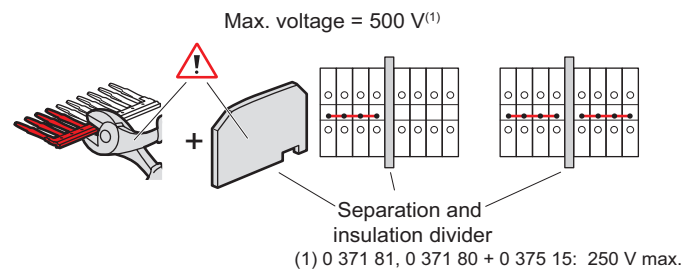

The voltage is derated in the case of an alternating connection configuration:

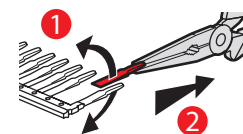

Max. voltage = 400 V⁽¹⁾

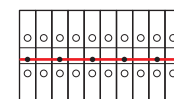

- (1) 0 371 81, 0 371 80 + 0 375 15: 250 V max.

Max. voltage = 250 V

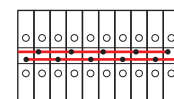

Viking 3 - Screw connection

Disconnect terminal blocks

Catalogue numbers: 0 371 80/81/82/83/84/85/86/87
0 375 15/16/17/18

6. ACCESSORIES (continued)

6.7 Measurement accessories

6.7.1. Measurement socket

Cat. Nos	For blocks	For plug \varnothing (mm)
0 375 27	6 mm pitch: - Open - With mini lever	4



The socket is fitted in one of the 2 areas for automatic insertion equipotential bridging combs. Its particular shape enables measurement even on a block fitted with a comb.

It is not possible to fit 2 sockets side by side with disconnect blocks.

6.7.2. IP2X safety tip adaptor, Cat. No. 0 394 95

- \varnothing 2 mm test plug - retractable tube
- For performing ad-hoc tests in accordance with regulations on the protection of workers
- Can be directly fitted with a \varnothing 4 mm plug



6.8 Shielding accessories

These accessories ensure safe, simple connection of cable shielding

6.8.1. Shielding clamps

Cat. Nos	For cables \varnothing (mm)
0 375 30	3 to 8
0 375 31	4 to 13.5
0 375 32	10 to 20

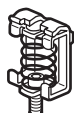

Fitting on
10 x 3 bar
Cat. No. 0 375 34

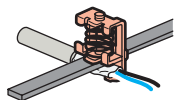

Fitting on rail
with accessory
Cat. No. 0 364 69

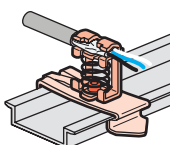

Fitting on plate
with M4 screws
(supplied)

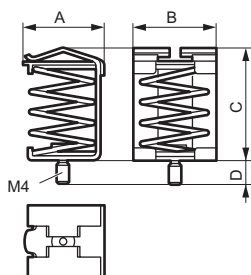
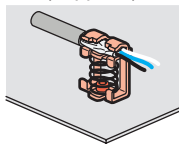

Cat. Nos	Dimensions (mm)			
	A	B	C	D
0 375 30	13.5	18	26	5.6
0 375 31	20	20.3	31.4	5.3
0 375 32	24.8	26	40	5.3

6. ACCESSORIES (continued)

6.8.2. Shielding bar, Cat. No. 0 375 34

- For use with end stops Cat. No. 0 375 12 (see section 6.12)
- 10 x 3 mm
- Length 1 m
- Steel

Shielding terminal block with end stops Cat. No. 0 375 12, bar Cat. No. 0 375 34 and clamps Cat. No. 0 375 30/31:

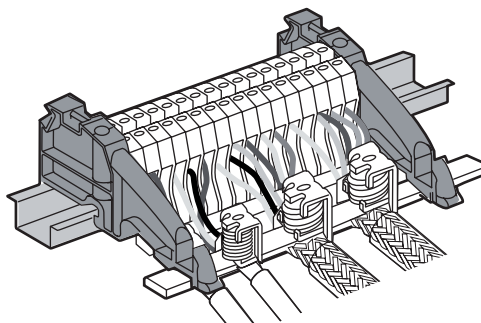

6.9 Rails

- Length 2 m
- Zinc-plated steel

Cat. Nos	Rail
0 374 04	┌ EN 60715 depth 7.5 mm
0 374 07	┌ depth 15 mm
0 477 22	┌ depth 7.5 mm with oblong holes
0 477 23	┌ depth 15 mm with oblong holes

6.10 45° mounting bracket, Cat. No. 0 394 49

- Set of 2 brackets providing a 45° rail angle
- Zinc-plated steel
- Supplied with 4 M6 screws, nuts and washers

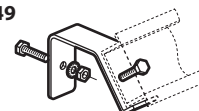

6.11 Adaptor for fixing on asymmetrical rail, Cat. No. 0 364 66

- For fitting blocks on \sqsubset rail
- Width 17 mm
- Increases the height of the block by 6 mm
- PC/ABS 960°C according to IEC EN 60695-2-11



6.12 End stops

Cat. No.	0 375 10	0 375 11	0 375 12	0 375 13
Pitch (mm)	6	8	10	12
For rails	┌ depth 15 mm ┌ EN 60715 depth 7.5 mm and 15 mm			┌ EN 60715
	-			┌ EN 60715

Cat. No. 0 375 10: Automatic screw-free fitting.

Cat. No. 0 375 12: End stop for bar bracket, protective conductor or shielding.

Note: other characteristics listed in the specific end stops technical data sheet.

Viking 3 - Screw connection Disconnect terminal blocks

Catalogue numbers: 0 371 80/81/82/83/84/85/86/87
0 375 15/16/17/18

6. ACCESSORIES (continued)

■ 6.13 Marking

CAB 3 markers:

International colour code digits, letters and conventional symbols.

Terminal block marking capacity:

- 4 x 0.15 to 0.5 mm² CAB 3 markers, up to 7 markers with marker holder

Cat. No. 0 383 92

- 3 x 0.5 to 1.5 mm² CAB 3 markers, up to 6 markers with marker holder

Cat. No. 0 383 92



The CAB 3 range provides consistency of marking on both terminal blocks and wiring.

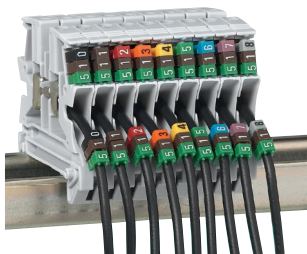

Pre-printed markers:

- Pitch 5/6/8 mm

- Supplied in pre-cut sheets

- Digits and numbers

- For reading horizontally or vertically

- Markers fitted quickly in strips on terminal blocks

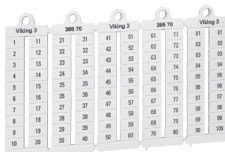

Blank markers:

Cat. No. 0 395 00 - 5 mm pitch.

Cat. No. 0 395 01 - 6 mm pitch.

Cat. No. 0 395 02 - 8 mm pitch.

- Supplied in pre-cut sheets

- Manual marking using indelible black felt-tip pen Cat. No. 0 395 98

- Markers fitted quickly in strips on terminal blocks

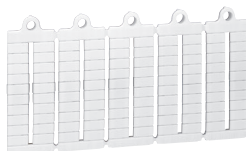

LEGRAND ADVANTAGE

The unique length of the marking areas on Viking 3 blocks enables markers to be fitted as a unit on a block whose pitch is larger than the marker.

Example: Marker Cat. No. 395 00 can be fitted on a 12 mm pitch block.