

EMS CX³ - Power supply & Connection Equipment

Cat. Nos: 4 149 01/02/03, 4 149 07/08/09/10, 4149 14, 4 149 45

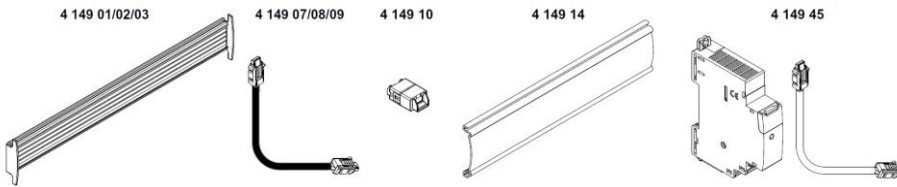

Contents	Pages
1. Description - Use	1
2. Range	1
3. Overall dimensions	1
4. Preparation - Connection	2
5. General characteristics	6
6. System architectures	9
6.1 Stand-alone	9
6.1.1 with local addressing	9
6.1.2 with remote addressing	10
6.2 Supervised	11
6.2.1 with local addressing	11
6.2.2 with remote addressing	13
7. Compliance and approvals	15

1. DESCRIPTION - USE

- . Equipment: dedicated to Energy Management System (EMS CX³) use.
- . Power supply module: allows the power up and distribution of the supply and of the communications data within the EMS CX³ system

2. RANGE

Communicating rails

- . Allow connection of EMS CX³ data
- . Allow the connection of several EMS CX³ modules at the rear through dedicated connectors on the same row.
- . Fixed directly on DIN rails of 7,5 mm or 15 mm depth
 - Cat. no 4 149 01: 1 rail of 18 DIN modules (315 mm length)
 - Cat. no 4 149 02: 1 rail of 24 DIN modules (420 mm length)
 - Cat. no 4 149 03: 1 rail of 36 DIN modules (630 mm length)

Communicating patch cords

- . Allow connection of EMS CX³ data
- . Allow the connexion between several EMS CX³ modules at the downstream through dedicated connectors or to connect several communicating rails to one another.
 - Cat. no 4 149 07: 10 patch cords of 250 mm length
 - Cat. no 4 149 08: 10 patch cords of 500 mm length
 - Cat. no 4 149 09: 5 patch cords of 1000 mm length

Communication patch cords connector

- Increases the length of communicating patch cords: communicating cords are clipped to either side of the connector.
Maximum total length allowed for 1 communicating cable cord: **3 meters**
Cat. n° 4 149 10

Plastic cover for communicating rails

- . Protects the unused portion of the communicating rail (**use of plastic cover is mandatory**). To be clip directly on the onto the DIN rail, can be cut to the required length
Cat. n° 4 149 14: 630 mm length

Power Supplier Module

- . Delivered with a separation white patch cord
- . Supplier.
- Primary voltage 95+250 V~
- Secondary voltage 12 VDC 500 mA
- Cat. n° 4 149 45: 1 module (17,8 mm) width

3. OVERALL DIMENSIONS

- . Communicating rails with the height spacer for mounting on DIN rails 15 mm depth (**Note:** Cat. no 4 149 01 is delivered without the height spacer)

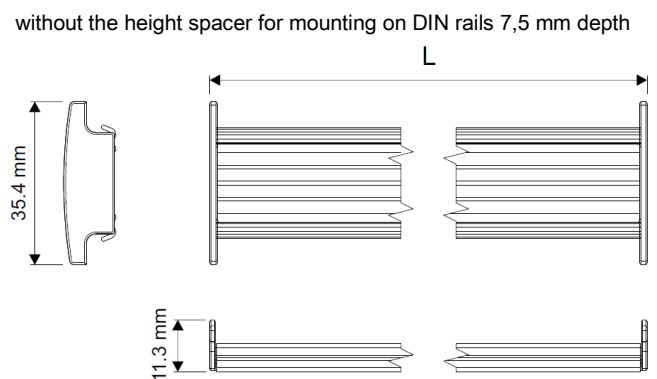
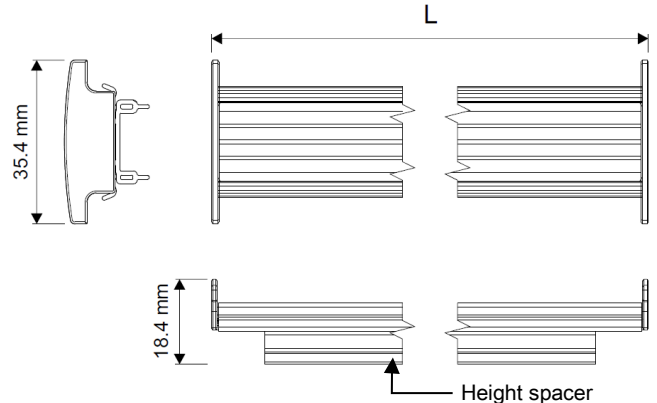

Cat. n°	L (mm)
4 149 01 (delivered without the height spacer which is not necessary)	315
4 149 02	420
4 149 03	630

EMS CX³ - Power supply & Connection Equipment

Cat. Nos: 4 149 01/02/03, 4 149 07/08/09/10, 4149 14, 4 149 45

3. OVERALL DIMENSIONS (continued)

. Communicating patch cords

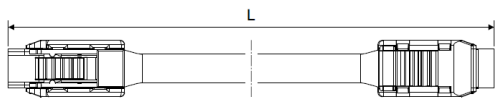

Cat. n°	L (mm)
4 149 07	250
4 149 08	500
4 149 09	1000

. Communication patch cord connector, cat. n° 4 149 10:

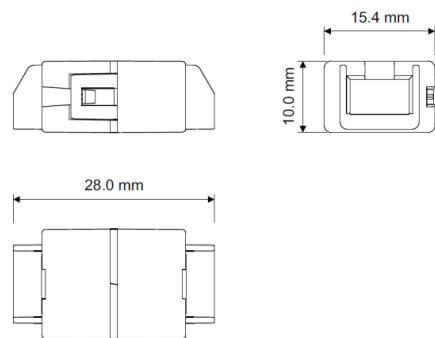

. Plastic cover for communicating rails, cat. n° 4 149 14:

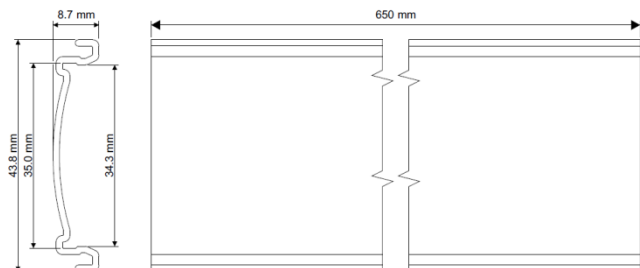

. Power supply module, cat. n° 4 149 45:

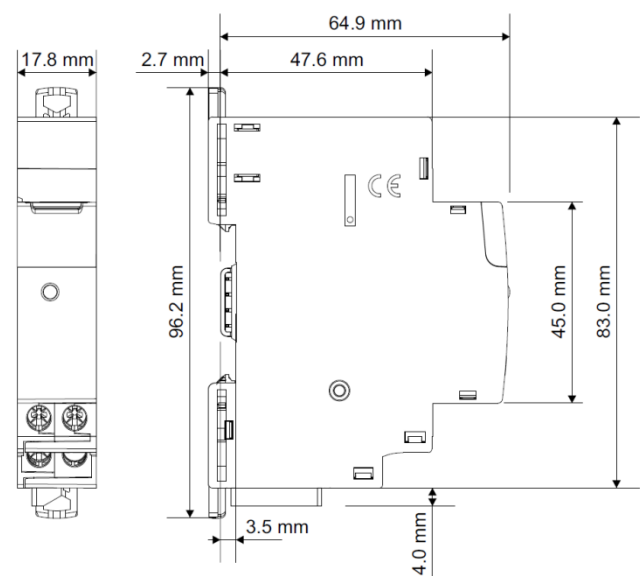

4. PREPARATION –CONNECTION

Assembly of the various elements of the system

. Communicating rail on a 15 mm depth DIN rail:

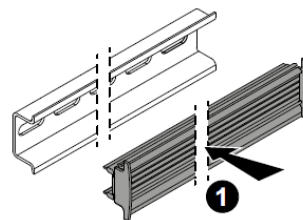
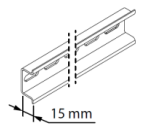

1. Clip the communicating rail on the DIN rail

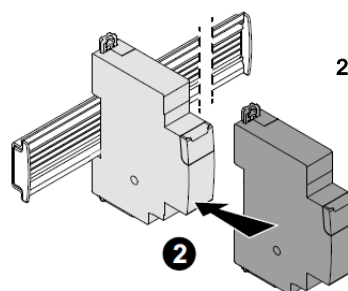

2. Clip the EMS CX³ devices



Do not slide EMS CX³ devices once fixed on the communicating rail

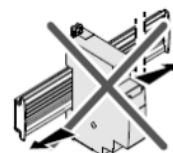

Do not cut the EMS CX³ communicating rail

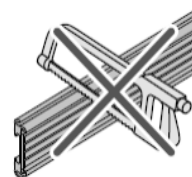

EMS CX³ - Power supply & Connection Equipment

Cat. Nos: 4 149 01/02/03, 4 149 07/08/09/10, 4149 14, 4 149 45

4. PREPARATION –CONNECTION (continued)

Assembly of the various elements of the system (continued)

. Communicating rail on a 7.5 mm depth DIN rail:

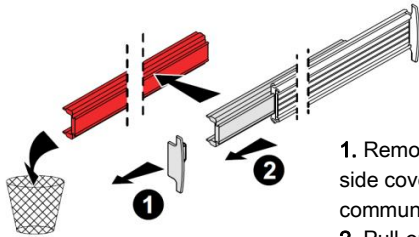
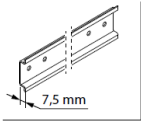

1. Remove one of the two side covers of the communicating rail
2. Pull-out the height spacer

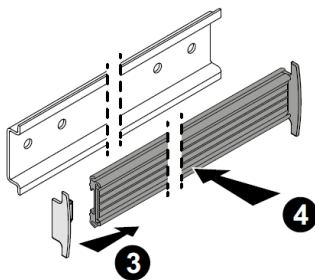

3. Refit the side cover
4. Clip the communicating rail on the DIN rail

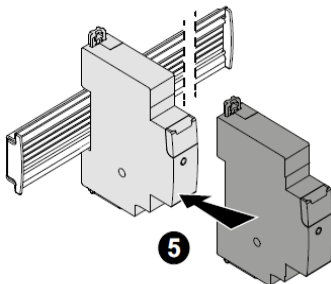

5. Clip the EMS CX³ devices



. Do not slide EMS CX³ devices once fixed on the communicating rail



. Do not cut the EMS CX³ communicating rail

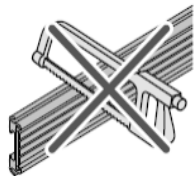

4. PREPARATION –CONNECTION (continued)

Assembly of the various elements of the system (continued)

. Communicating patch cords:

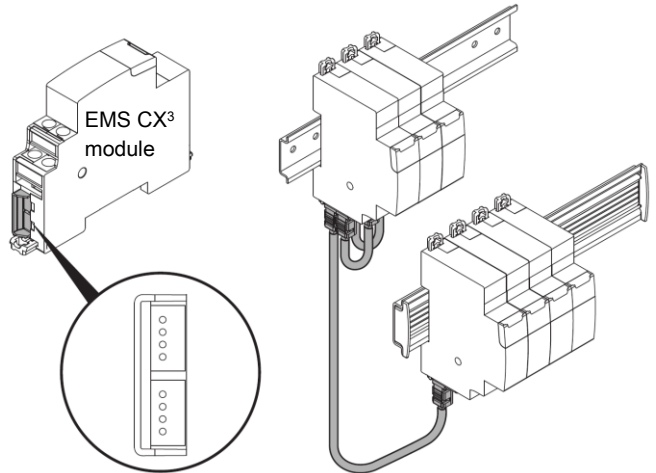

. Communication patch cord connector:

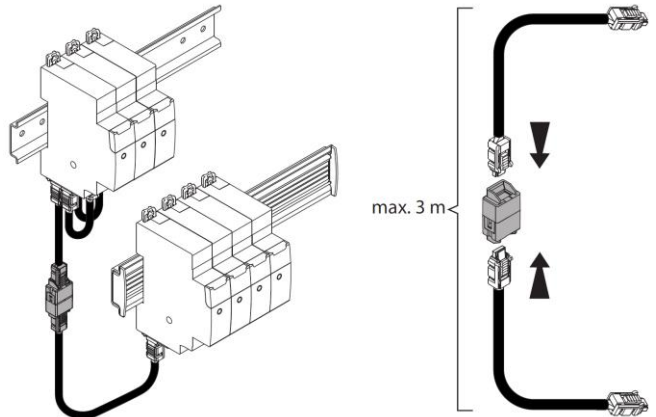

. Plastic cover for communicating rails:



to put mandatory on the unused portion of the communicating rail

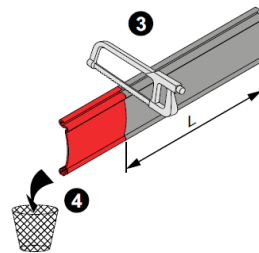

. Cut the protection plastic cover to the required length

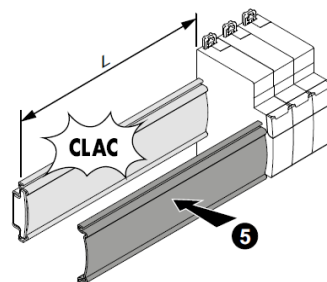

Clip the protection plastic cover on the remaining exposed part of the communicating rail

EMS CX³ - Power supply & Connection Equipment

Cat. Nos: 4 149 01/02/03, 4 149 07/08/09/10, 4149 14, 4 149 45

4. PREPARATION –CONNECTION (continued)

. Power Supply Module

Fixing:

. On symmetric rail EN/IEC 60715 or DIN 35 rail

Operating positions:

. Vertical, Horizontal, Upside down, On the side

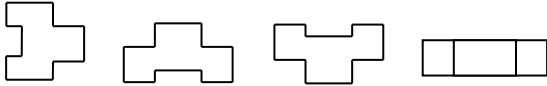

Power Supply:

Primary voltage 95+250 V~

Secondary voltage 12 VDC 500 mA

. Two ways:

via specific communication patch cords (cat. nos 4 149 07/08/09) to connect at the downstream through dedicated ports

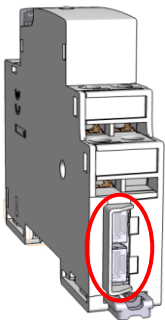

via specific communication rails (cat. nos 4 149 01/02/03) to connect at the rear through dedicated connectors.

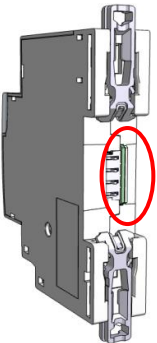

Power supply terminals:

. Terminal depth: 8 mm.

. Stripping length: 8 mm

Power supply screw head:

. Mixed, slotted and Pozidriv n°1 (UNI7596 type Z1).

Recommended tightening torque:

. 1 Nm.

Recommended tools:

. For the terminals: Pozidriv n°1 or flat screwdriver 4 mm.

. For fixing: flat screwdriver 5.5 mm (6 mm maximum).

. For configuration DIP switches: flat screwdriver 2 mm

4. PREPARATION –CONNECTION (continued)

Conductor type:

	Copper cable	
	Without ferrule	With ferrule
Rigid Cable	1 x 0,5 mm ² to 1,5 mm ² 2 x 1,5 mm ²	-
Flexible Cable	1 x 0,5 mm ² to 1,5 mm ² 2 x 1,5 mm ²	1 x 0,5 mm ² to 1,5 mm ² 2 x 1,5 mm ²

Wiring diagrams:

. Power supply protected by an MCB:

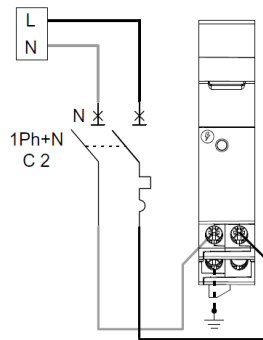

. Power supply protected by a Fuse holder:

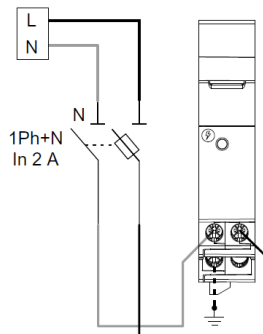

Note: when there are several power supplies in a system, just one of them must be earthed.

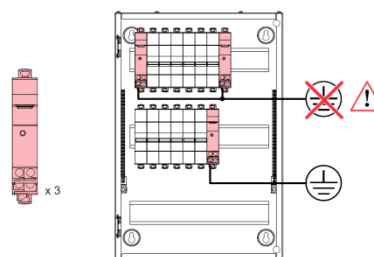
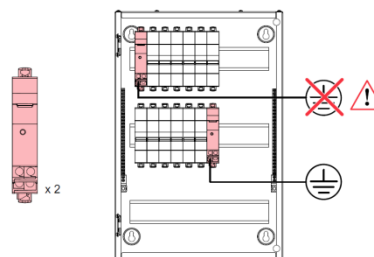

EMS CX³ - Power supply & Connection Equipment

Cat. Nos: 4 149 01/02/03, 4 149 07/08/09/10, 4149 14, 4 149 45

4. PREPARATION –CONNECTION (continued)

Connection with several Power supply modules:

. Each power supply can provide 500 mA of current thus, whenever the absorption of 500 mA is exceeded, it is necessary to add an additional power supply to the system.

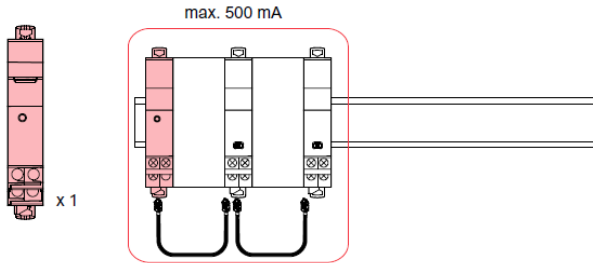

In this case is necessary to separate the two groups of devices with the decoupling white cable (delivered with the EMS CX³ Power supply module)

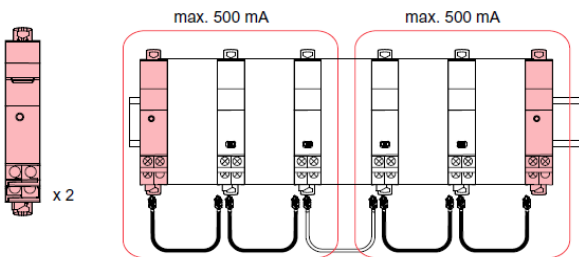

Note: in a system (beneath an EMS CX³/Modbus interface) it is possible to use a maximum of 3 power supply modules = 3 groups of 500 mA.

. in the image below is described the use of the 2 decoupling white cables

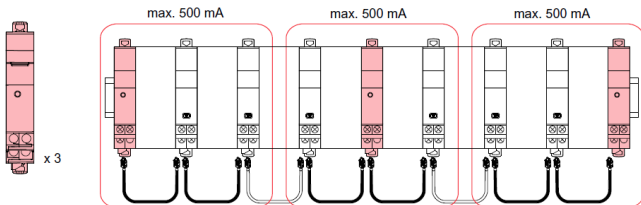

4. PREPARATION –CONNECTION (continued)

Max. EMS CX³ modules consumptions @ 12 VDC

Cat n°	Description	W	mA
4 149 18	Closed Rogowski - 3 x Single phase Measure mod. 63A	0,418	34,8
4 149 19	Closed Rogowski - Single phase Measure mod. 63 A	0,409	34,1
4 149 20	Closed Rogowski - Three phase Measure mod. 63A	0,418	34,8
4 149 21	Closed Rogowski - Three phase Measure mod. 125 A	0,418	34,8
4 149 22	Open Rogowski - Three phase Measure mod. 630 A	0,418	34,8
4 149 23	Measure mod. with CT	0,391	32,6
4 149 24	Open Rogowski - Three phase Measure mod. 1600 A	0,418	34,8
4 149 25	Open Rogowski - Three phase Measure mod. 3200 A	0,418	34,8
4 149 26	Pulse Concentrator	0,288	24,0
4 149 27	Open Rogowski - Three phase Measure mod. 6300 A	0,418	34,8
4 149 29	CA+SD Auxiliary	0,236	19,7
4 149 30	Universal Signalling mod.	0,377	31,4
4 149 31	Control & State for modular latching relays and contactors	0,372	31,0
4 149 32	Universal Control mod.	0,456	38,0
4 149 36/37	Mini configuration module	0,438	36,5
4 149 40	EMS CX ³ /RS485 interface	0,344	28,7

Data connection (EMS CX³ modules inter-connection):

. Like all the other EMS CX³ module, the Power supply module can be indifferently connected:

. via specific communication patch cords (cat. nos 4 149 07/08/09)



Implementing: with this configuration, the plastic protection cover of the backside communication ports on the EMS CX³ module must be keep on.

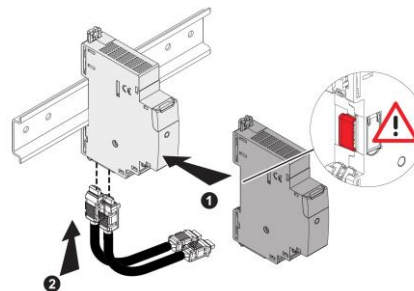

EMS CX³ - Power supply & Connection Equipment

Cat. Nos: 4 149 01/02/03, 4 149 07/08/09/10, 4149 14, 4 149 45

4. PREPARATION –CONNECTION *(continued)*

Data connection (EMS CX³ modules inter-connection)
(continued):

. via specific communication rails (cat. nos 4 149 01/02/03).

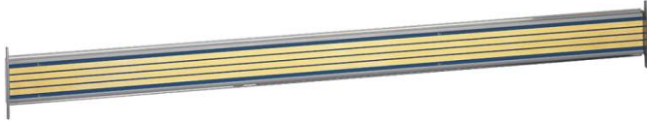

Implementing: with this configuration, the plastic protection cover of the backside communication ports on the EMS CX³ module must be removed.

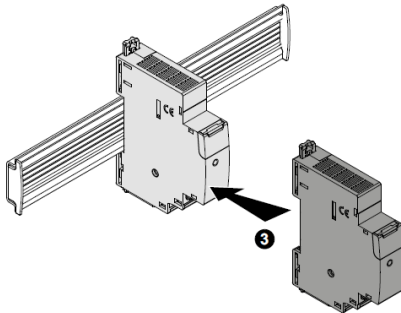
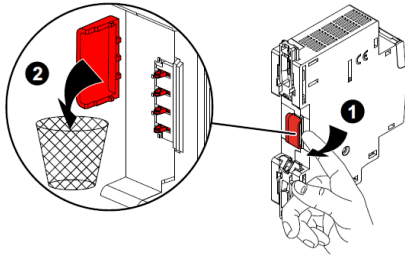

IMPORTANT:

. It is forbidden to put several power supply modules on the same communicating rail.

Labelling:

. Circuit identification by way of a label inserted in the label holder situated on the front of the product.

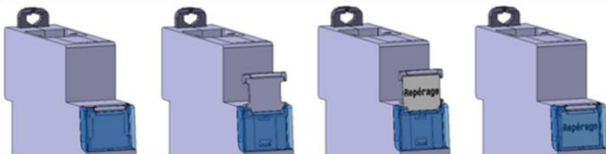

5. GENERAL CHARACTERISTICS

Front face marking:

. By permanent ink pad printing (red line) and laser marking



Operating range of the supplier

Lateral side marking:

. By laser.

left side: Standard and programming information

IEC 61131-2
IEC 61558-2-16

Standards

legrand
Made in Italy

LEGRAND - BP 30076
87002 LIMOGES CEDEX FRANCE
legrand.com

Legrand address

right side: cabling and traceability information

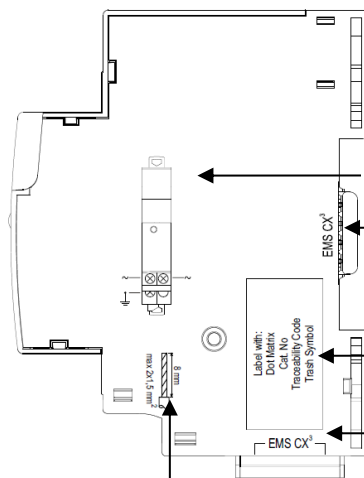

Wiring diagram

Data connection with communication rail

Traceability information

Data connection with communication patch cords

Cabling information

EMS CX³ - Power supply & Connection Equipment

Cat. Nos: 4 149 01/02/03, 4 149 07/08/09/10, 4149 14, 4 149 45

5. GENERAL CHARACTERISTICS *(continued)*

Frontal Led:

. Indicates the status of operation of the supplier:

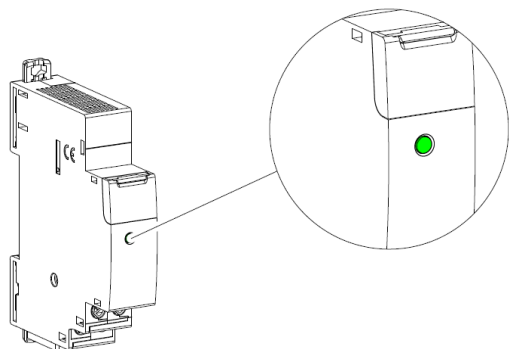

- Steady green → system OK
- Steady off → supplier malfunctioning

Supplier operating voltage:

- . Primary side:
95 ÷ 250 V ~
75 ÷ 150 mA
- . EMS side:
12 VDC
500 mA

Rated frequency:

- . 50/60 Hz with standard tolerances.

Insulation voltage:

- . U_i = 400 V

Impulse withstand voltage U_{imp}:

- . Primary side / EMS ports:
wave 1,2 / 50 µs: 6 kV
alternate current 50 Hz / 1 min.: 4,4 kV

Pollution degree:

- . 2 according to IEC/EN 60898-1.

Overvoltage category:

- . III

Dielectric strength:

- . 2500 V

Plastic material:

- . Self-extinguishing polycarbonate.
- . Heat and fire resistant according to IEC/EN 60695-2-12, glow-wire test at 960°C.
- . Classification UL 94 / IECEN 60695-11-10: V1

Ambient operating temperature:

- . Min. = -25°C. Max. = +70°C

Ambient storage temperature:

- . Min. = -40°C. Max. = +70°C

5. GENERAL CHARACTERISTICS *(continued)*

Protection Index:

- . Protection index of terminals against direct contacts: IP2X (IEC/EN 60529).
- . Protection index of terminals against solid and liquid bodies (wired device): IP 20 (IEC/EN 60529).
- . Protection index of the front face against solid and liquid bodies: IP 40 (IEC/EN 60529).
- . Class II, front panel with faceplate.

Average weight per device:

	Weight (kg)
Communicating rail 18 modules	0,071
Communicating rail 24 modules	0,095
Communicating rail 36 modules	0,142
Communicating cable 250 mm	0,005
Communicating patch cords 500 mm	0,01
Communicating patch cords 1000 mm	0,018
Communication patch cord connector	0,003
Plastic cover for communicating rail	0,056
EMS CX ³ Power Supply module	0,069

Volume when packed:

	Volume (dm ³)
Communicating rail 18 modules in a bag of 1 piece (pack per 10 bags)	3,3
Communicating rail 24 modules in a bag of 1 piece (pack per 10 bags)	3,3
Communicating rail 36 modules in a bag of 1 piece (pack per 10 bags)	4,8
Communicating cable 250 mm in bag of 10 pieces (pack per 5 bags)	3,7
Communicating cable 500 mm in bag of 10 pieces (pack per 5 bags)	3,7
Communicating cable 1000 mm in bag of 5 pieces (pack per 5 bags)	3,7
Communication patch cord connector in bag of 5 pieces (pack. per 5 bags)	3,7
Plastic cover for communicating rail in a bag of 1 piece (pack per 10 bags)	4,8
EMS CX ³ Power supply module + decoupling cable (pack per 1)	0,33

EMS CX³ - Power supply & Connection Equipment

Cat. Nos: 4 149 01/02/03, 4 149 07/08/09/10, 4149 14, 4 149 45

5. GENERAL CHARACTERISTICS *(continued)*

Make your own EMS CX³ patch cord:

. It is given the possibility to build your "self-made" cables using, for each cable, following material.

- JST connector:

Code: GHR-04V

Quantity: 2

Characteristics:

n° of contacts: 4

pitch: 1.25 mm

. View:



. Overall dimensions:

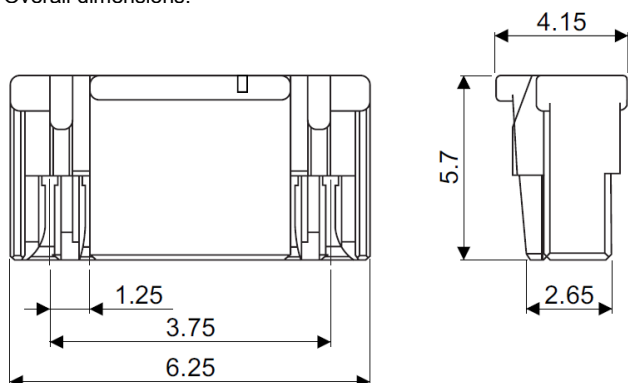

- Crimp tool:

Code: SSSL-002T-P0.2

Quantity: 8 (4 for each JST connector)

Applicable wire: 0.05 ÷ 0.13 mm² (30 ÷ 26 AVG)

. View:



. Overall dimensions:

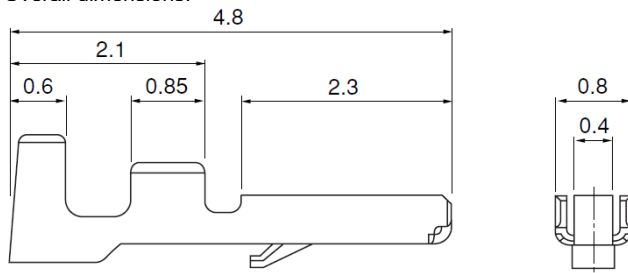

5. GENERAL CHARACTERISTICS *(continued)*

Make your own EMS CX³ patch cord *(continued)*:

- Cables:

Quantity: 4

Type:

PVC insulation

UL1061

Section: 0.13 mm² (AVG 26) UL1061

Note:

. Use 4 different wire colours to clearly identify the conductors.

. It is possible use:

a multi-core cable (with features mentioned) already sheathed

.4 individual cables (with features mentioned) and a PVC sheath (e.g. PVC UL 224 105° diameter.3 mm, Black colour)

. Colour sequence:

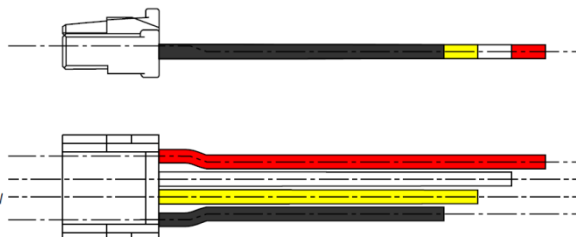

IMPORTANT:



. The maximum total length allowed for 1 communicating cable cord remains **3 meters**

. The proper functioning of the system can only be guaranteed by using the pre-cabled EMS CX³ Communicating patch cords (cat. nos 41 49 07/08/09)

6. SYSTEM ARCHITECTURES

The EMS CX³ is a polyvalent system and, according to the needs of the customer, can be set up and/or used as “Stand-alone” or “Supervised” system. Based on this choice the configuration and addressing methods are different.

Four possible architectures are provided:

6.1 Stand-alone system

6.1.1 with local addressing (through the track wheel)

6.1.2 with remote addressing (through a computer)

6.2 Supervised (Computer Supervisory System)

6.2.1 with local addressing

6.2.2 with remote addressing

6.1 Stand-alone system

. **Stand-alone** = autonomous system. To be used by the end-user if it is not necessary to have a computer for the supervision outside the envelope. Everything can be managed on site.

6.1.1 Stand-alone system with local addressing (through the track wheel)

Local addressing advantages:

- No configuration software needed to set-up the installation
- **It is not necessary to use a computer to manage settings** (configurations, test, ...) and to use the system (visualize and be alerted, ...). Everything can be done through the Mini configuration module (local display, cat. no 4 149 36/37). [Refer to the technical sheet dedicated to this module for details].
- No communication Interfaces or gateways are required.
- Installation can be done without the intervention of a System Integrator

Programming procedure:

. For EMS CX³ modules which need some: mandatory through the lateral DIP-switches of each EMS CX³ module (see § “Module configuration”)

Addressing procedure:

. For all EMS CX³ modules: mandatory through the track wheel located on the top upper face of each EMS CX³ modules

. Marked from 0 to 9 in order to locally define the Modbus address of the EMS CX³ modules

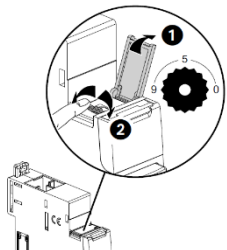

Note for Measure Module “3x single phase”:

This module is to be consider as 3 modules with 3 different Modbus Address. The module takes automatically the two addresses immediately following to the programmed one (e.g. Programmed address = 12, Addresses of the module 12, 13, 14)

Consequences of the local addressing mode (through the track wheel):

- . Each device of the system must be addressed.
- . Addresses available: from 1 to 9
- . Address 0 not permitted
- . It is possible to assign to several devices the same address with the purpose of grouping different functions, **because they are related to the same electrical circuit**. For example, it is possible to assign the same address to a signalling auxiliary module (cat. no 4 149 29), a universal control module (cat. no 4 149 32), a measuring module, and so on. In this way on the EMS CX³ mini configuration module (local display) the grouped function will be displayed as a unique “device” with all grouped functions. [Refer to the schemes hereunder]

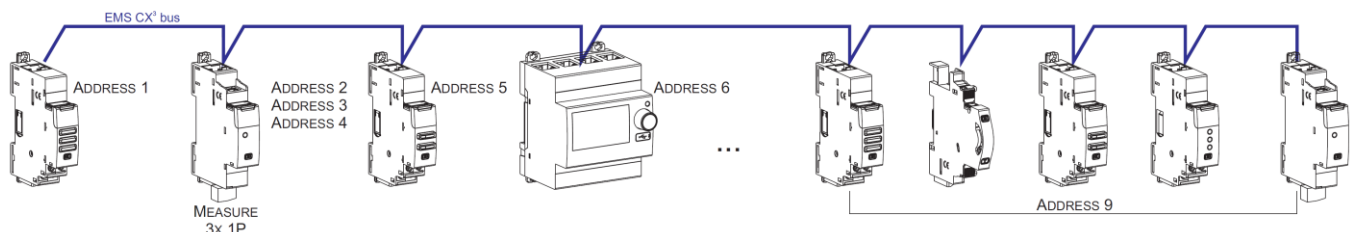

Note for the mini configuration module (local display)

- . It is possible to assign it the same address as another EMS CX³ through the programming menu of the device
- . The mini configuration module can be placed everywhere in the EMS CX³ bus

6. SYSTEM ARCHITECTURES

6.1 Stand-alone system *(continued)*

6.1.2 Stand-alone system with remote addressing (through a computer)

Remote addressing advantages:

- Whole configuration (addresses and functions) can be set up through the EMS Configuration software
- Configuration software available for free
- **Automatic detection of the EMS CX³ modules** installed in the system (characteristics, functions, configuration...)
- **Increased settings possibilities: load shedding function**
- **Increased addressing: up to 30 Modbus addresses in a system**

Programming procedure:

. For EMS CX³ modules which need some: possible through the lateral DIP-switches of each EMS CX³ module or via the configuration software *(see § "Module configuration")*.

Addressing procedure:

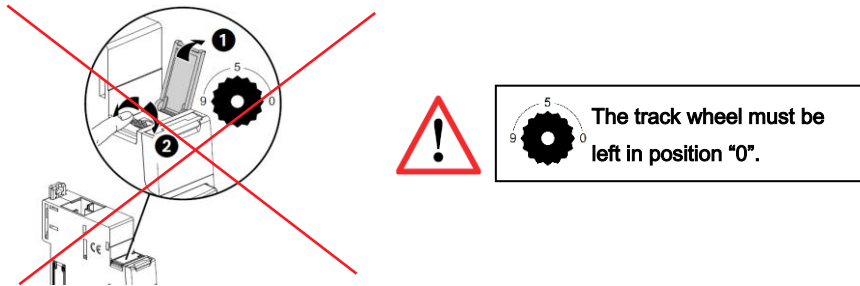

. It is not necessary to address the EMS CX³ modules. **The track wheel must be left in default position "0".**

. All the addressing/configuring procedure will be done with the Configuration Software (available online for free)

. With remote addressing, the software does the automatic detection of modules installed in the system, but the supervision is not possible until the user assigns the remote address and all the characteristics to each module.

Note: it is mandatory to connect the computer to the Mini configuration module with an USB-micro USB cable. *[For more details, refer to the technical data sheet of the Mini configuration module EMS CX³]*

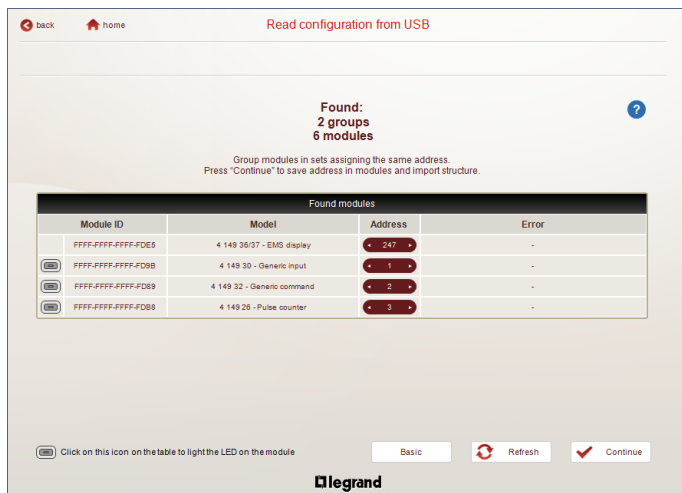
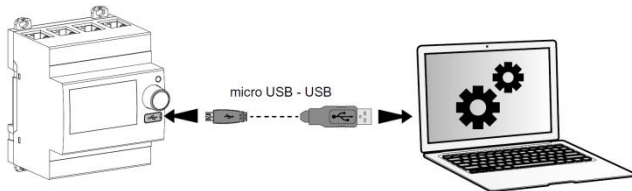

Note for Measure Module "3x single phase":

This module is to be consider as 3 modules with 3 different Modbus Address. The module takes automatically the two addresses immediately following to the programmed one (e.g. Programmed address = 2, Addresses of the module 2, 3, 4)

6. SYSTEM ARCHITECTURES

6.1 Stand-alone system (continued)

6.1.2 Stand-alone system with remote addressing (through a computer) (continued)

Consequences for the system architecture:

- for 1 mini configuration module (cat. no 4 149 36/37)
 - o up to **30 EMS CX³ modules** (e.g. 30 devices grouped per functions with addresses from 1 to 30)

It is possible to assign to several devices the same address with the purpose of grouping different functions, **because they are related to the same electrical circuit**. For example, it is possible to assign the same address to a signalling auxiliary module (cat. no 4 149 29), a universal control module (cat. no 4 149 32), a measuring module, and so on. In this way on the EMS CX³ display or in a supervision system the grouped function will be displayed as a unique “device” with all grouped functions. [Refer to the schemes here under]

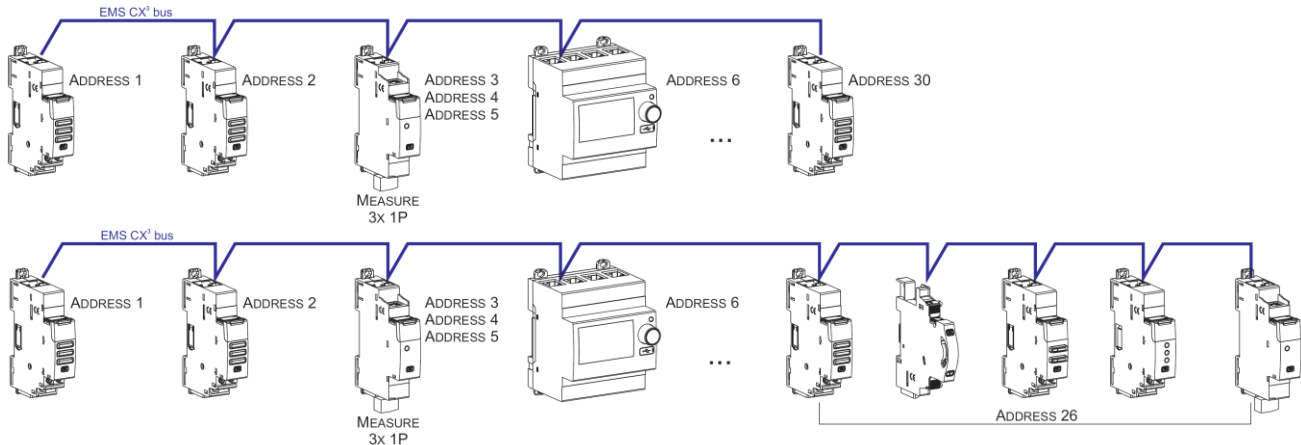

Note for the mini configuration module (local display)

- . It is possible to assign it the same address as another EMS CX³
- . The mini configuration module can be placed everywhere in the EMS CX³ bus

6.2 Supervised system (Computer Supervisory System)

. **Supervised system** = System to be used through a Computer Supervisory System to remotely read data from the EMS CX³ devices and/or do operations on these devices (e.g. commands of a motor driven or contactor ...).

6.2.1 Supervised system-with local addressing (through the track wheel)

Local addressing advantages:

- No configuration software needed to set-up the installation
- Installation can be done without the intervention of a System Integrator

Programming procedure:

. For EMS CX³ modules which need some: mandatory through the lateral DIP-switches of each EMS CX³ module (see § "Module configuration")

Addressing procedure:

. For all EMS CX³ modules: mandatory through the track wheel located on the top upper face of each EMS CX³ modules

. Marked from 0 to 9 in order to locally define the Modbus address to EMS CX³ modules

In this system the Modbus address of an EMS CX³ module device or group of modules (several functions) is obtained considering the address of the interface Modbus/EMS CX³ Interface as tenth and the address of a device or group of function as unit (e.g. Interface address 1 = 10 → address of module n°5 = Modbus address 15)

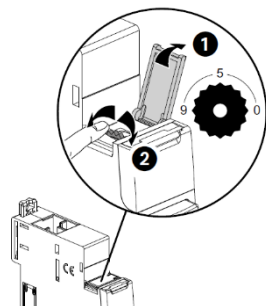

Note for Measure Module “3x single phase”:

This module is to be consider as 3 modules with 3 different Modbus Address. The module takes automatically the two addresses immediately following to the programmed one (e.g. Programmed address = 12, Addresses of the module 12, 13, 14)

6. SYSTEM ARCHITECTURES *(continued)*

6.2 Supervised system (Computer Supervisory System) *(continued)*

6.2.1 Supervised system-with local addressing (through the track wheel) *(continued)*

Consequences of the local addressing mode (through the track wheel):

- . Each device of the system must be addressed.
- . Addresses available: from 1 to 9
- . Address 0 not permitted

It is possible to assign to several devices the same address with the purpose of grouping different functions, **because they are related to the same electrical circuit**. For example, it is possible to assign the same address to a signalling auxiliary module (cat. no 4 149 29), a universal control module (cat. no 4 149 32), a measuring module, and so on. In this way on the EMS CX³ display or in a supervision system the grouped function will be displayed as a unique "device" with all grouped functions. *[Refer to the scheme hereunder]*

Note: In this configuration the Modbus address of an EMS CX³ module device or group of modules (several functions) is obtained considering the address of the interface Modbus/EMS CX³ Interface as tenth and the address of a device or group of function as unit (e.g. Interface address 1 = 10 and device address = 5 → Modbus address = 15)

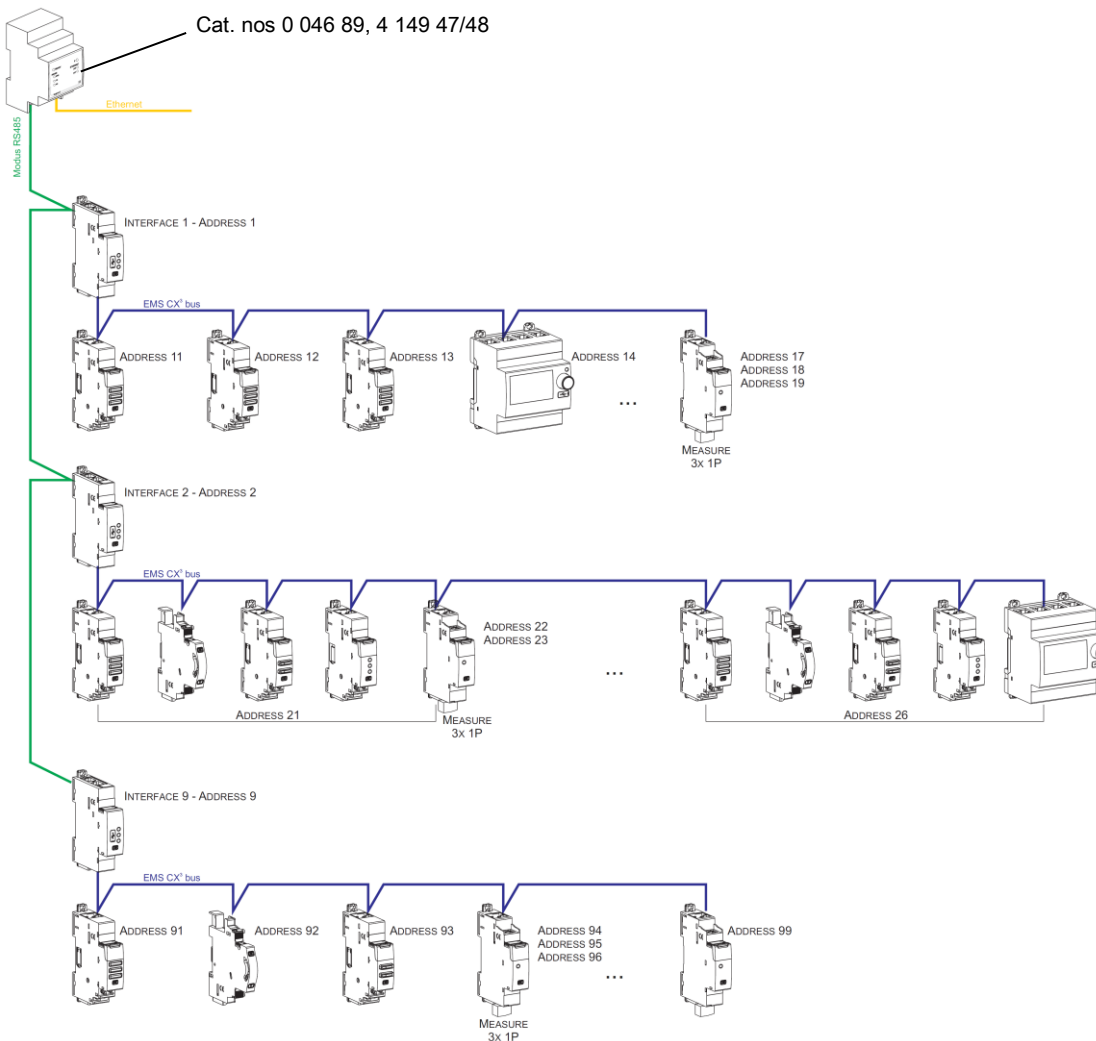

Consequences for the system architecture:

- for 1 IP/Modbus gateway (cat. no 0 046 89):
 - o up to **81 Modbus address**
 - o mandatory limit of max. **9 Modbus/EMS CX³ interfaces** or max. **1000 m of Modbus cable** (cable Belden 9842, Belden 3106A or equivalent) or max. **50 m of Category 6 cable (FTP or UTP)**.
- for 1 Modbus/EMS CX³ Interface (cat. no 4 149 40):
 - o up to **30 EMS CX³ modules** (ex. 30 devices grouped per functions with addresses from 1 to 9)

Note: with local addressing, the Modbus/EMS CX³ interface, does the automatic detection of modules (characteristics, functions, configuration...)

6. SYSTEM ARCHITECTURES *(continued)*

6.2 Supervised system (Computer Supervisory System) *(continued)*

6.2.2 Supervised system-with remote addressing (through a computer)

Remote addressing advantages:

- Whole of configuration (addresses and functions) can be done a remotely through the EMS Configuration software
- Configuration software available for free
- **Automatic detection of the EMS CX³ modules** installed in the system (characteristics, functions, configuration...)
- **Increased settings possibilities: load shedding function**
- Increased addressing: **up to 32 Modbus/EMS CX³ interfaces**
- Increased addressing: **up to 247 Modbus addresses in a system**

Programming procedure:

. For EMS CX³ modules which need some: possible through the lateral DIP-switches of each EMS CX³ module or via the configuration software *(see § "Module configuration")*.

Addressing procedure:

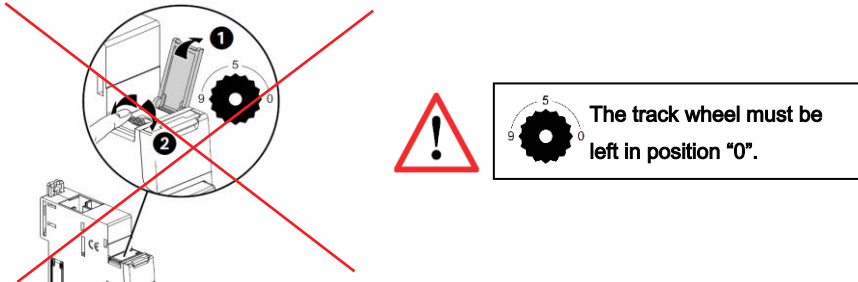

. It is not necessary to address the EMS CX³ modules. **The track wheel must be left in default position "0"**.

. All the addressing/configuring procedure will be done with the Configuration Software (available online for free)

. With remote addressing, the software does the automatic detection of modules installed in the system, but the supervision is not possible until the user assigns the remote address and all the characteristics to each module.

Note: it is mandatory to connect the computer to the different Modbus/EMS CX³ interface with an USB-micro USB cable (one interface at a time). *[For more details, refer to the technical data sheet of the Modbus/EMS CX³ interface]*

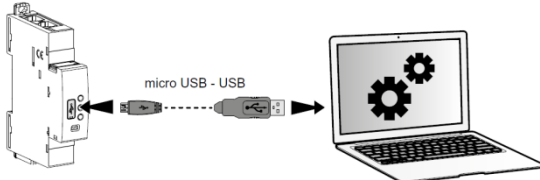

Read configuration from USB

Found:
2 groups
6 modules

Group modules in sets assigning the same address.
Press "Continue" to save address in modules and import structure.

Found modules			
Module ID	Model	Address	Error
FFFF.FFFF.FFFF.FDF1	4 149 40 - Modbus/EMS Interface	1	-
FFFF.FFFF.FFFF.FD09	4 149 32 - Generic command	2	-
FFFF.FFFF.FFFF.FD0B	4 149 30 - Generic input	1	-
FFFF.FFFF.FFFF.FD08	4 149 26 - Pulse counter	3	-

Click on this icon on the table to light the LED on the module

legrand

Note for Measure Module "3x single phase":

This module is to be consider as 3 modules with 3 different Modbus Address. The module takes automatically the two addresses immediately following to the programmed one (e.g. Programmed address = 2, Addresses of the module 2, 3, 4)

6. SYSTEM ARCHITECTURES *(continued)*

6.2 Supervised system (Computer Supervisory System) *(continued)*

6.2.2 Supervised system-with remote addressing (through a computer) *(continued)*

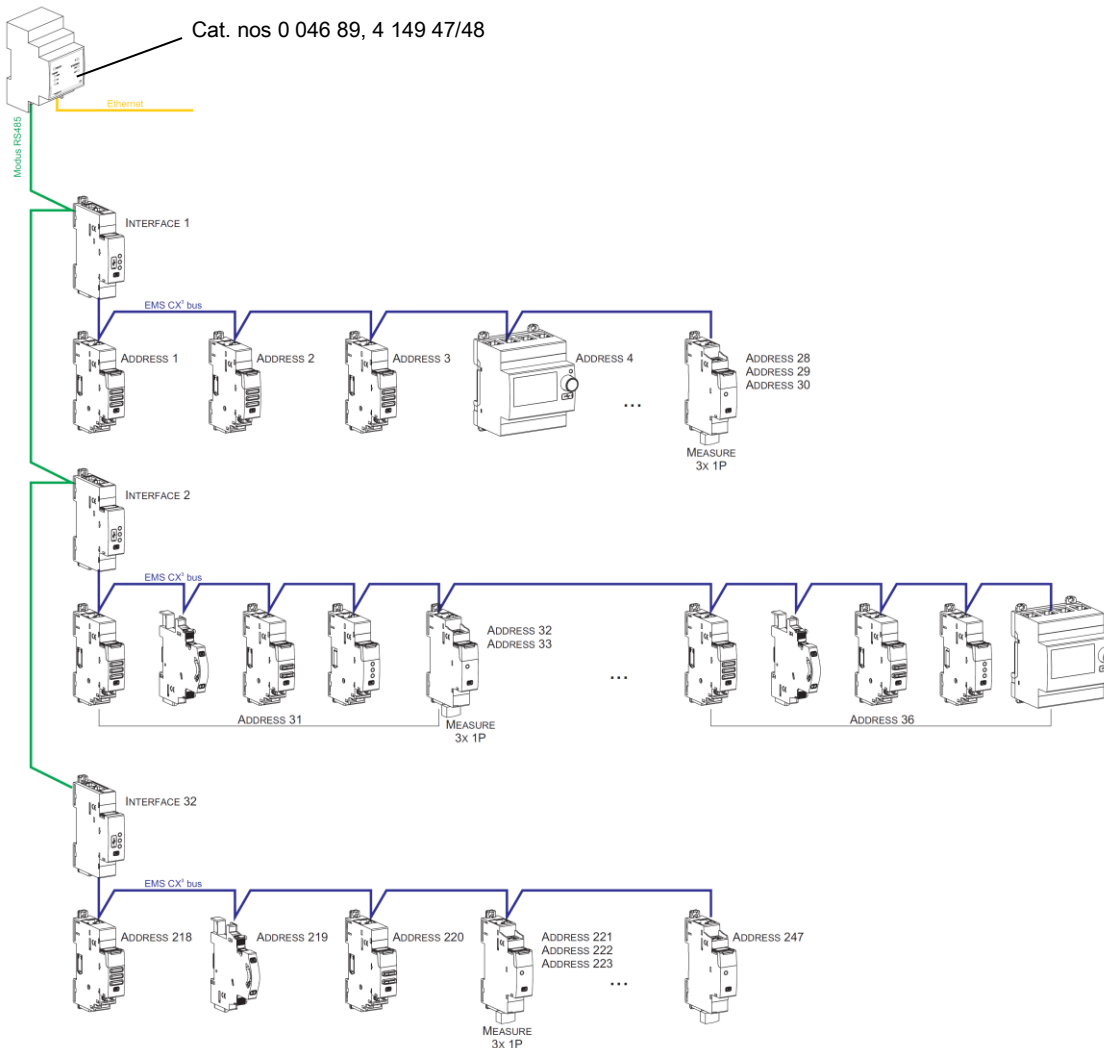

Consequences for the system architecture:

- for 1 IP/Modbus gateway (cat. no 0 046 89):
 - o up to **247 Modbus address**
 - o Because of Modbus: mandatory limit of max. **32 Modbus/EMS CX³ interfaces** or max. **1000 m of Modbus cable** (cable Belden 9842, Belden 3106A or equivalent) **or max. 50 m of Category 6 cable (FTP or UTP)**.
- for 1 Modbus/EMS CX³ Interface (cat. no 4 149 40):
 - o up to **30 EMS CX³ modules or grouped modules** (e.g. 30 devices grouped per functions with addresses from 1 to 30)

It is possible to assign to several devices the same address with the purpose of grouping different functions, **because they are related to the same electrical circuit**. For example, it is possible to assign the same address to a signalling auxiliary module (cat. no 4 149 29), a universal control module (cat. no 4 149 32), a measuring module, and so on. In this way on the EMS CX³ display or in a supervision system the grouped function will be displayed as a unique “device” with all grouped functions. *[Refer to the scheme up here]*

7. COMPLIANCE AND APPROVALS

Compliance to standards:

- . Compliance with Directive on electromagnetic compatibility (EMC) n° 2014/30/EU
- . Compliance with low voltage directive n° 2014/35/EU.
- . Electromagnetic Compatibility:
 - IEC/EN 61131-2
 - IEC/EN 60558-2-16

Environment respect - Compliance with EU directives:

- . Compliance with Directive 2011/65/EU as amended by Directive 2015/863 (RoHS 2) on the restriction of the use of certain hazardous substances in electrical and electronic equipment.
- . Compliance with REACH regulation (1907/2006): at the date of the publication of this document no element of the SVHC substance list (updated on 27/06/2018) is present in these products.
- . WEEE directive (2012/19/EU): the sale of this product is subject to a contribution to eco-organisations in each country responsible for managing end-of-life products in the field of application of the European Waste Electronic and Electrical Equipment Directive.

Plastic materials:

- . Halogens-free plastic materials.
- . Marking of parts according to ISO 11469 and ISO 1043.

Packaging:

- . Design and manufacture of packaging compliant to decree 98-638 of the 20/07/98 and also to directive 94/62/CE.

Environmental profile:

- . PEP document available

Installation software:

- . XL PRO³.