

[www.legrandoc.com](http://www.legrandoc.com)

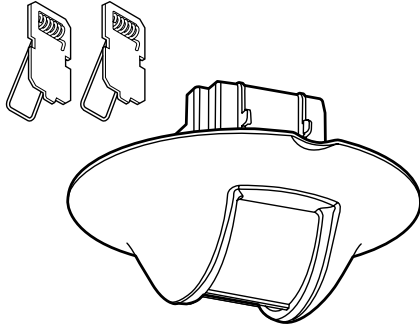

CONTENTS	Page
1. Use .....	1
2. Technical characteristics .....	1
3. Installation .....	2
4. Dimensions .....	3
5. Connection .....	3
6. Operation .....	4
7. Settings .....	4
8. Performance .....	6
9. Care .....	6
10. Standards .....	6
11. Troubleshooting .....	6

**1. USE**

DALI sensor Cat. No: 0 489 36 uses PIR (passive infrared) technology to detect movement, and also incorporates a light level meter.

It can be surface-mounted on a concrete ceiling using box Cat. No. 0 488 75, or flush-mounted directly in a suspended ceiling using claws or in a flush-mounting box Cat. No. 0 800 31.

It is suitable for indoor passageways such as corridors, and can manage a group of 64 ECGs maximum.

This sensor is fully configured using configuration tool Cat. No. 0 882 30/ BMSO4001 with which it is possible to:

- Control a single zone or group
- Distribute DALI ECG addresses
- Pair DALI ECGs with their sensor
- Designate Master and Slave sensors
- Define the standby level when there is no detection
- Define the standby time
- Configure all the other sensor settings (for example, daylight setpoint, time the lighting remains on after detection, choice of detection technology, operating mode, etc.)

DALI sensor Cat. No. 0 489 36 is powered with 16 VDC by the DALI bus.

A DALI power supply Cat. No. 0 035 15 or 0 035 13 can supply this voltage to the DALI BUS with a maximum of 200 mA.

**2. TECHNICAL CHARACTERISTICS**

Voltage: 16 V=  
 No-load power consumption: 10 mA  
 Usage temperature: -5°C to +45°C  
 Storage temperature: -20°C to +70°C  
 Impact resistance: IK04  
 Penetration by solid and liquid matter: IP41  
 Weight: 114 g

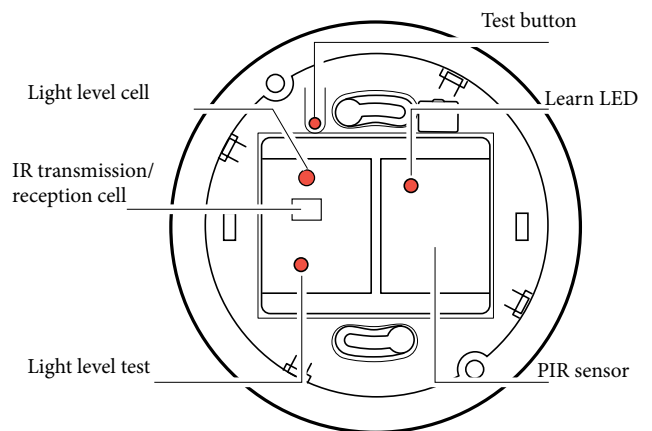

3. INSTALLATION

■ 3.1 Sensor location

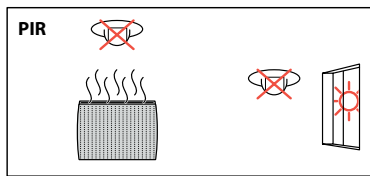

■ 3.2 Recommended light exposure

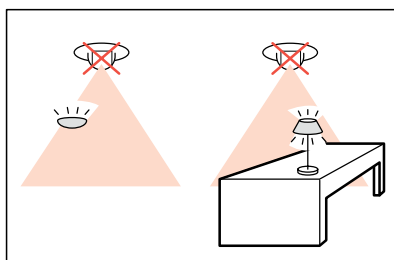
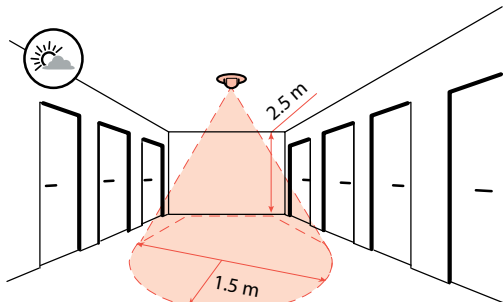

3. INSTALLATION (CONTINUED)

■ 3.3 Mounting

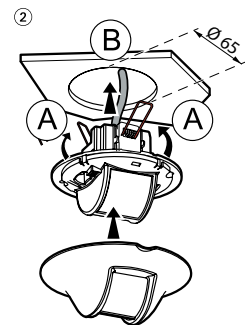
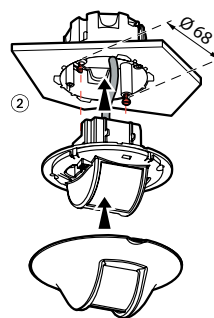
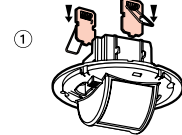
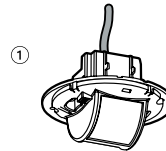
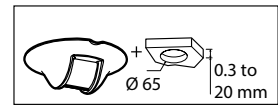
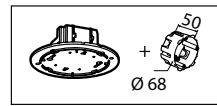

■ 3.4 Recommended light exposure

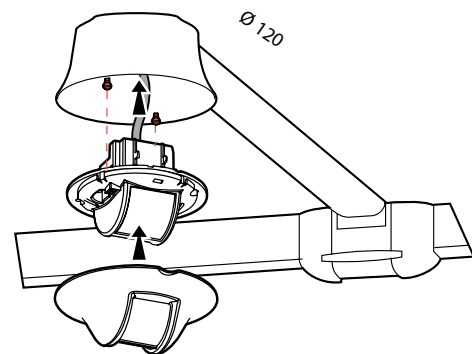
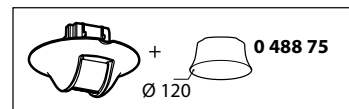

■ 3.5. Removal

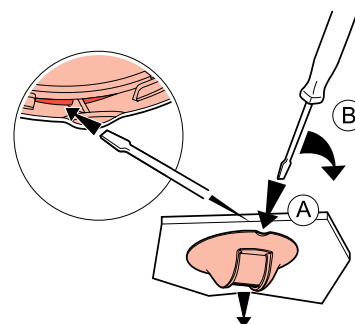

4. DIMENSIONS

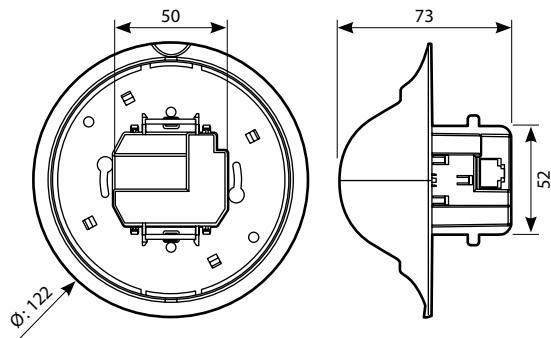



5. CONNECTION

■ 5.1 Wiring with a single sensor:

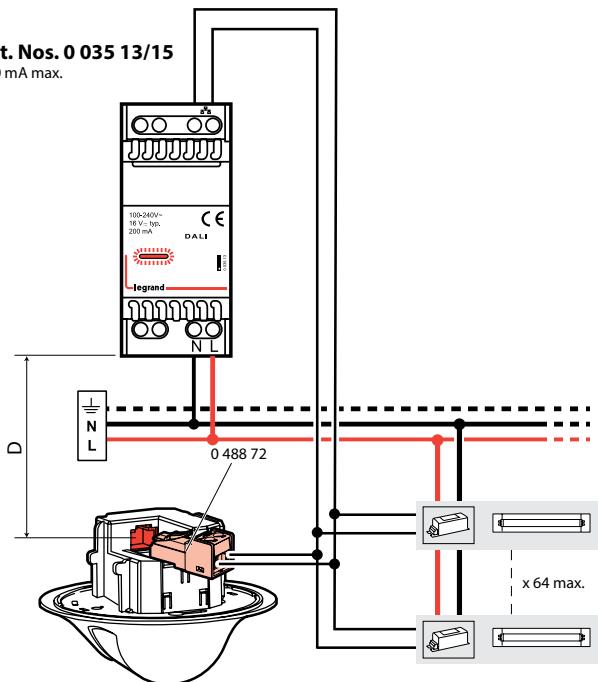

Cat. Nos. 0 035 13/15  
200 mA max.



D	
≤ 100 m	0.5 mm <sup>2</sup>
≤ 150 m	0.75 mm <sup>2</sup>
≤ 300 m	1.5 mm <sup>2</sup>

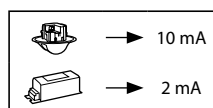

5. CONNECTION (CONTINUED)

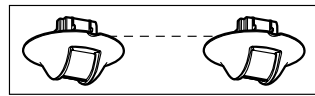

■ 5.2 Wiring with several sensors

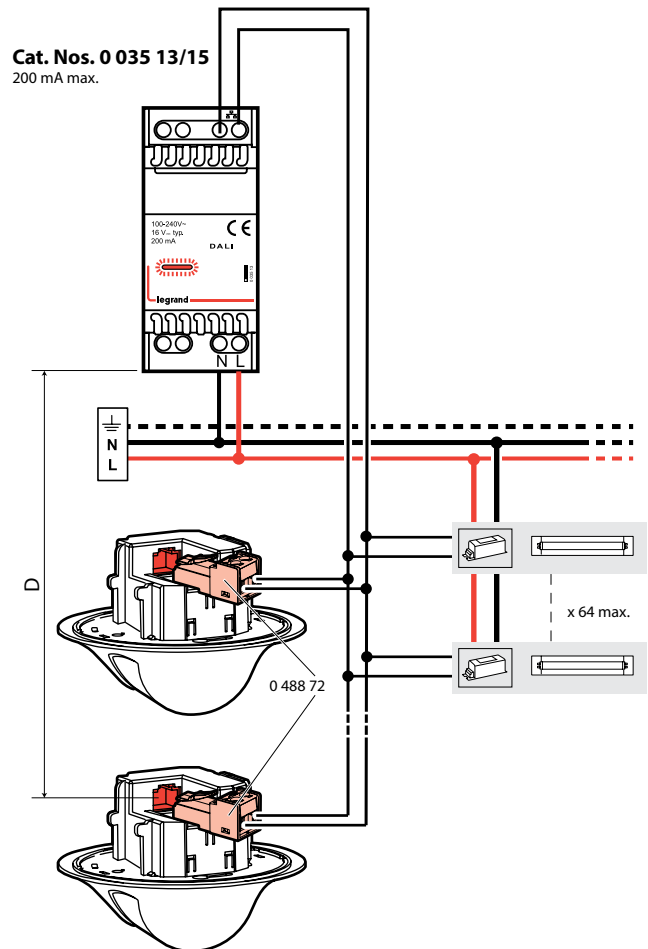

5. CONNECTION (CONTINUED)

■ 5.3 Wiring with several sensors and one control unit:

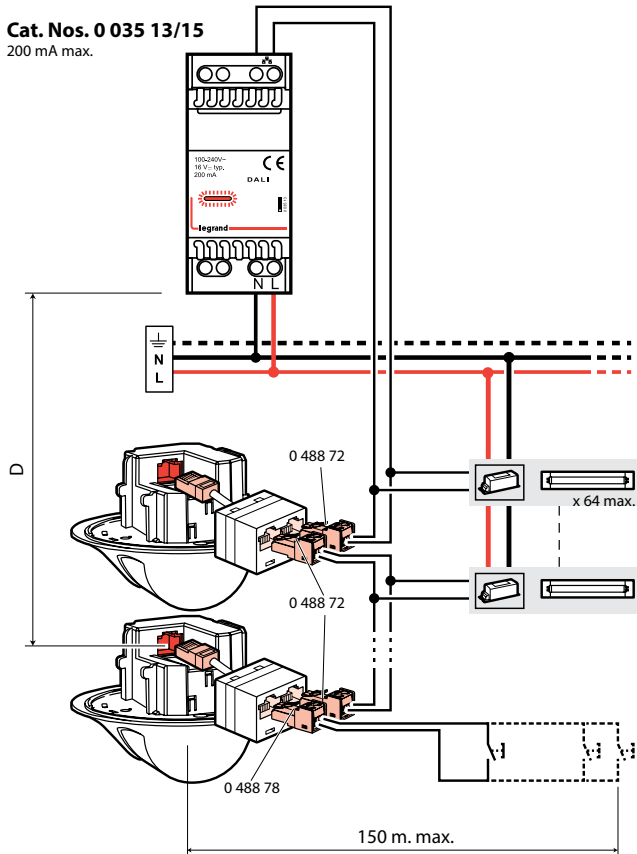
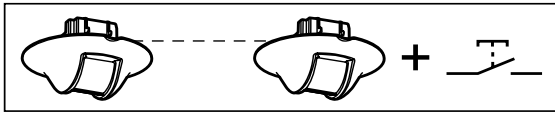

The push-button must be connected to a master sensor via Cat. No. 0 488 78.

**0 488 78**

D	
≤ 100 m	0.5 mm <sup>2</sup>
≤ 150 m	0.75 mm <sup>2</sup>
≤ 300 m	1.5 mm <sup>2</sup>

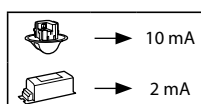

6. OPERATION

■ 6.1 TEST function

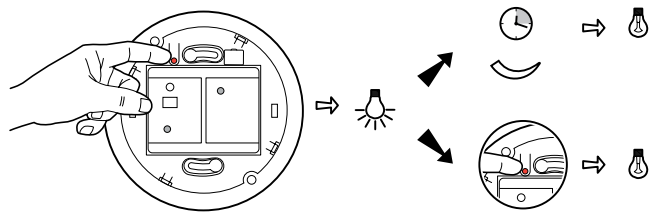

■ 6.2 Configuration

Configuration of a DALI installation is described in the DALI programming manual.

7. SETTINGS

■ 7.1 Detection settings

Sensor settings	Default value	Modifiable parameters	Configuration tools 0 882 30 BMSO4001	
<b>Time delay</b>	15 min	5 s - 2 hrs	✓	
<b>Sensitivity</b>	PIR (very high)	Low, medium, high, very high	✓	
<b>Modes</b>	<b>Auto on/Auto off</b>	Active	Enable/Disable	✓
	<b>Walkthrough</b>	Inactive	Enable/Disable	✓
	<b>Manual on/Auto off</b>	Inactive	Enable/Disable	✓
<b>Detection system</b>	<b>Initial</b>	PIR	Not modifiable	✓
	<b>Maintain</b>	PIR	Not modifiable	✓
<b>Alarm</b>	Inactive	Enable/Disable	✓	

**Time delay:** Length of time the load is on after detection.

**Pulse mode (= push-button mode):** If the time delay is set to 0, the sensor is in push-button mode. In this case, there is a 10-minute time delay before the load is switched off. If the setting is overridden or there is a new detection, the 10-minute time delay starts again.

Available with configuration tool 0 882 30/BMSO4001.

**Sensitivity:** Detection range setting.

7. SETTINGS (CONTINUED)

7.1 Detection settings(continued)

**Auto on/Auto off mode:**

The lighting switches on automatically:  
- On detection of presence if the natural light level is insufficient.  
The lighting switches off automatically:  
- Where no presence is detected and at the end of the time delay set  
- Or if the natural light level is sufficient (regulation activated)  
Another detection causes automatic switch-on if there is insufficient light.

**Walkthrough mode:**

- If no presence is detected in the 20 seconds following an initial detection, the device will switch off the load after 3 minutes.  
- If another movement is detected in the 3 minutes following initial detection, the device will switch off the load at the end of the set time delay.

**Manual on/Auto off mode:**

The lighting is switched on via a manual control, but switches off automatically:  
- Where no presence is detected and at the end of the time delay set  
After switch-off, if another movement is detected within a 30-second period, the lighting switches on automatically.  
The Restart function must be enabled.  
After 30 seconds, the lighting has to be switched on manually.

**Detection system:**

**Initial detection:** The load is switched on as soon as the first detection occurs if the natural light level is below the light level threshold.

**Maintain:** The load remains active if another presence is detected.

**Restart:** In manual mode. After switch-off, any new detection within a 30-second period triggers an automatic switch-on.

After 30 seconds the device must be switched on manually.

Possible in Manual on/Auto off mode only, by disabling the Detection System: "Initial"

**Alarm:** An audible signal is emitted before switch-off. 1 minute before, then 30 seconds, then 10 seconds.

7.2 Light level settings

Sensor settings		Default value	Modifiable parameters	Configuration tools 0 882 30 BMSO4001
Daylight setpoint		150 lux	5 - 1275 lux	✓
Advanced mode	Calibration	–	0 - 99995 lux	✓
	Light regulation	Active	Enable/ Disable	✓
	Light contribution	Auto	Auto - 1275 lux	✓

**Daylight setpoint:** Value at which the load comes on if the natural light level is less than the setting.

**Eye function:** Value 0 (eye on configuration tool 0 882 30/ BMSO4001) is used to save the ambient light level in the room as a daylight setpoint.

7.2 Light level settings (continued)

Advanced mode:

**Calibration:** The ambient light level measured with a luxmeter must then be transmitted to the sensor.

**Regulation:** Automatic switch-off of the load 10 minutes after the daylight setpoint is exceeded with an additional safety threshold (to avoid lights switching off at the wrong moment).

**Light contribution:** Quantity of additional lux provided by the load being switched on.

When the light contribution parameter is set to "Auto" on configuration tool Cat. No. 0 882 30/BMSO4001, the sensor automatically calculates how much light is provided.

7.3 Modifying the settings using the configuration tool

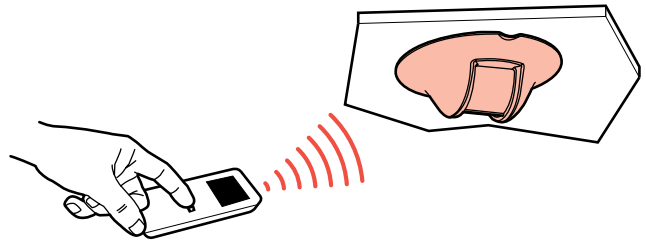

0 882 30/BMSO4001: Advanced configuration tool

When the sensor receives an IR command via the configuration tool, a red LED lights up acknowledging the modification.

For more information about setting parameters, refer to the data sheet for the configuration tool Cat. No. 0 882 30.

## 8. PERFORMANCE

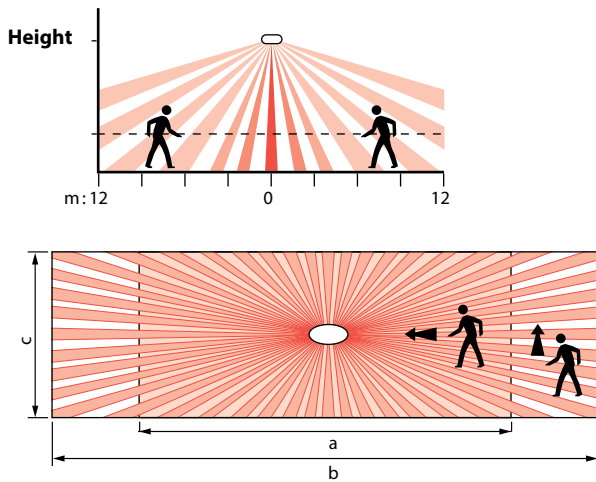

		Low sensitivity (25%)			Medium sensitivity (50%)		
		a (m)	b (m)	c (m)	a (m)	b (m)	c (m)
Height (m)	2.5	7	10	3	8	14	3
	3	7	10	3	8	14	3
	3.5	9	10	3	12	14	3
	4	10	8	3	13	9	3

		High sensitivity (75%)			Very high sensitivity (100%)		
		a (m)	b (m)	c (m)	a (m)	b (m)	c (m)
Height (m)	2.5	10	16	3	16	24	3
	3	10	16	3	16	24	3
	3.5	14	16	3	17	24	3
	4	15	10	3	18	14	3

## 9. CARE

Keep the lens clean.  
Clean the surface with a cloth.  
Do not use acetone, tar-removing cleaning agents or trichloroethylene.  
Resistant to the following products: - Hexane  
- Methylated spirit  
- Soapy water  
- Diluted ammonia  
- Bleach diluted to 10%  
- Window-cleaning products

**Caution:**  
Always test before using other special cleaning products.

## 10. STANDARDS

Directive: EC  
Installation standards: NFC 15-100  
Product standards: NF EN 50428  
Environmental standards:  
- European directive 2002/96/EC: WEEE (Waste Electrical and Electronic Equipment)  
- European directive 2002/95/EC: RoHS (Restriction of Hazardous Substances)  
- Decrees and/or regulations: Public buildings  
Workplace buildings  
High-rise buildings

**NB:**  
All technical information is available online at

 [www.legrandoc.com](http://www.legrandoc.com)

## 11. TROUBLESHOOTING

PROBLEMS	CAUSES	SOLUTIONS
The lighting stays on when there is no-one present	Sources of interference such as draughts, vibration or radiators may cause nuisance tripping	1- Reduce the sensitivity level 2- If the interference continues with the configuration tool, go into Detection system, select Maintain and then choose PIR or US detection 3- If the interference still continues, move the sensor away from sources of interference
The lighting does not switch off during the day when there is an adequate natural light level	Regulation function inactive Daylight setpoint too high Too much light provided	Enable the regulation function Reduce the light level threshold Check that the sensor is positioned correctly in relation to the window Decrease the power of the luminaires
The lighting switches off when there are people present and the natural light level is inadequate (darkness)	Time delay too short Detection sensitivity too low Daylight setpoint too low	Increase the time delay 5 to 15 minutes is recommended for work areas Increase the sensitivity Move the sensor closer to the work area Increase the threshold