

# DX<sup>3</sup> STOP ARC 6000 A

## Phase + Neutral, neutral on left side

Cat. N°(s): 4 159 50 / 51 / 52



CONTENTS	PAGE
1. Description, use.....	1
2. Range .....	1
3. Overall dimensions .....	1
4. Preparation – Connection .....	1
5. General characteristics.....	3
6. Compliance and approvals .....	14
7. Curves.....	15
8. Auxiliaries and accessories .....	21
9. Safety.....	21

### 1. DESCRIPTION - USE

Arc fault detection device integrated with Residual Current Circuit Breaker with Overload Protection (RCBO) with contact position indication for control, protection against short-circuits and overloads, and isolation of electrical circuits, protecting people from direct and indirect contact and protecting installations from insulation faults. Reduction of the risk of fire ignition in the electrical circuit, protection against short-circuits and overloads, isolation of electrical circuits.

#### Symbol:

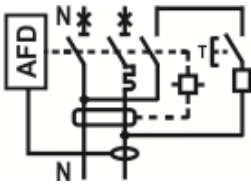

#### Technology:

- . Limiting device
- . The Neutral contact closes before and opens after the Phase contact
- . The phase pole provides protection and isolation for the phase circuit
- . The neutral pole provides isolation for the neutral circuit

### 2. RANGE

#### Polarity:

- . 2 poles including 1 protected pole and 1 neutral pole

#### Width:

- . 3 modules (54 mm)

#### Rated current In:

- . 10 / 16 / 20 A, C curve

#### Magnetic tripping curve:

- . C curve (between 5 In and 10 In)

#### Type:

- . AC (residual currents)

#### Sensitivity:

- . 30 mA

### 2. RANGE (continued)

#### Rated voltage and frequency:

- . 230 V ~, 50 Hz with standard tolerances

#### Breaking capacity:

- . Icn = 6000 A in accordance with standard EN/IEC 61009-1

### 3. OVERALL DIMENSIONS

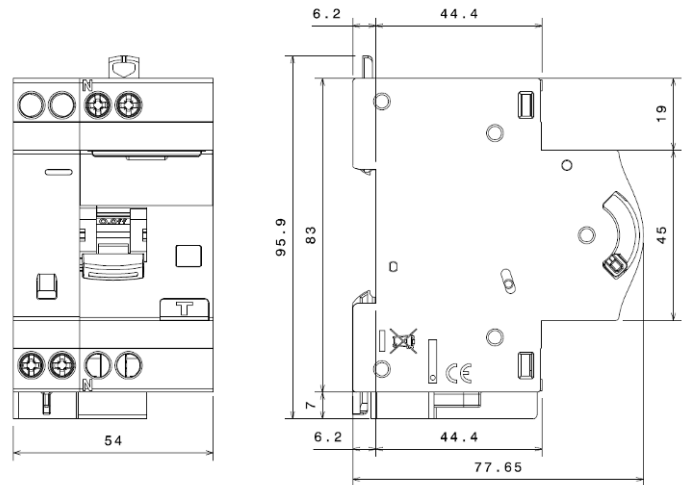

### 4. PREPARATION - CONNECTION

#### Mounting:

- . On symmetrical rail EN 60715 or DIN 35 rail

#### Operating positions:

Vertical      horizontal      upside down      Flat

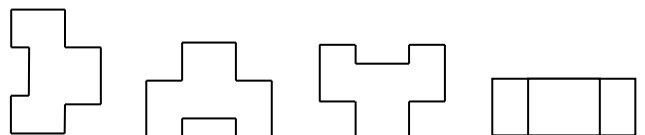

#### Trip indication on residual current fault:

- . Yellow indicator on the front

#### Power supply:

- . From the top

**Phase + Neutral, neutral on left side**

**4. POSITIONING - CONNECTION (continued)**

**Connection:**

- . Terminals protected against direct finger contact IP20 when wired device
- . Cage terminals, with release and captive screws
- . Terminals fitted with shutters preventing a cable being placed under the terminal, with the terminal partly open or closed
- . Alignment and spacing of the terminals permitting shutters with the other products via fork supply busbars
- . Terminal depth: 14 mm at the top and 12 mm at the bottom
- . Screw head: mixed head, slotted head and Pozidriv no. 2
- . Tightening torques:
  - Recommended: 1.6 to 2 Nm
  - Min.: 1.2 Nm
  - Max.: 2.8 Nm

**Conductor type:**

- . Copper cable at the top and bottom of the product
- . Cable cross-section

	Without ferrule	With ferrule
Rigid cable	1 x 1.5 to 16 mm <sup>2</sup> 2 x 1.5 to 6 mm <sup>2</sup>	-
Flexible cable	1 x 1.5 to 10 mm <sup>2</sup> 2 x 1.5 to 4 mm <sup>2</sup>	1 x 1.5 to 10 mm <sup>2</sup>

**Required tools:**

- . For the terminals:
  - 5.5 mm blade screwdriver
  - Pozidriv n°2 screwdriver
- . For the latching:
  - 5.5 mm blade screwdriver recommended / 6 mm maximum
  - Pozidriv n°2 screwdriver

**Manual actuation of the DX<sup>3</sup> STOP ARC:**

- . Ergonomic 2-position handle
- "O-OFF" : device open
- "I-ON" : device closed

**Contact status display:**

- . By marking of the handle
- "O-OFF" in white on a green background = contacts open
- "I-ON" in white on a red background = contacts closed

**Arc fault device status display:**

- . By both indicator light and mechanical indicator

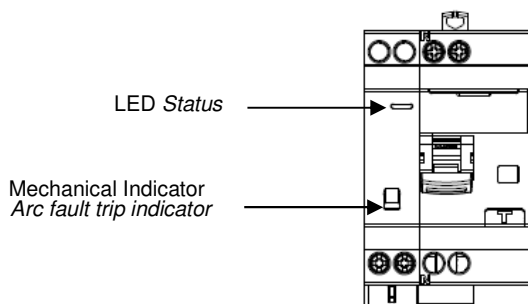

**4. POSITIONING - CONNECTION (continued)**

Indicator meaning code

Indicators state	meaning
	No or incorrect electrical source or/and device switched off
	Normal running: The circuit is monitored and protected by the arc fault device
	Arc fault detected: The device tripped to avoid the risk of fire Installation has to be verified
	Abnormal running: The circuit is not protected by the arc default device.

**Insulation tests:**

- . Very important:  
Disconnect output wires and handle must be OFF.

**Arc fault detection tests:**

- . The DX<sup>3</sup> STOP ARC is equipped with an auto-test function running continuously. The LED indicates if an abnormal running is detected.

**Sealing:**

- . Possible in the open or closed positions

**Labelling:**

- . Circuit identification by way of a label inserted in the label holder situated on the front of the product.



**Phase + Neutral, neutral on left side**

**5. GENERAL CHARACTERISTICS**

**Neutral earthing system:**

. IT, TT, TN

**Marking on the front side:**

. By permanent ink pad printing

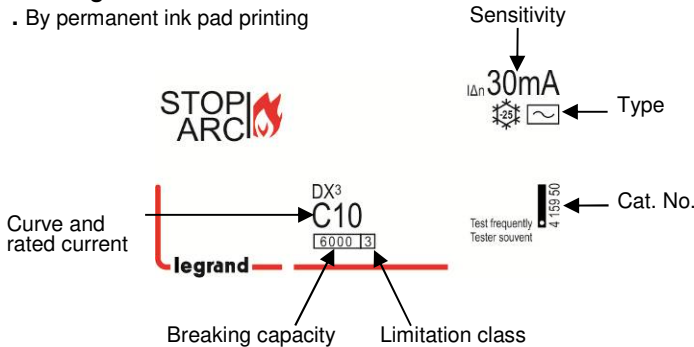

**Marking on the upper panel:**

. By permanent ink pad printing

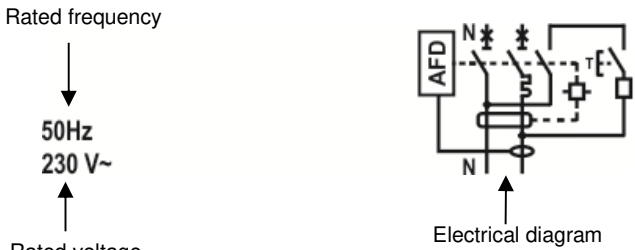

**Rated voltage**

. The terminals upstream and downstream of the neutral pole are marked with an "N" moulded close to the screw heads.

**Minimum operating voltage:**

. U = 70 V (without auxiliaries)  
. U = 95 V (with auxiliaries)

**Maximum operating voltage:**

. U = 250 V

**Test operating voltages:**

I $\Delta$ n	30 mA
min. U	180 V~
max. U	264 V~

**Breaking capacity:**

. With a single-phase network (with alternating current 50 Hz)

Standard	Breaking capacity	Voltage between poles	Breaking capacity
EN/IEC 61009-1	I <sub>cs</sub>	230 V	6 kA
	I <sub>cn</sub>		6 kA

**Residual breaking capacity:**

. In accordance with standard EN/IEC 61009-1 section 9.12.11.4d (I $\Delta$ m: short-circuit to earth) I $\Delta$ m = 3 kA

**5. GENERAL CHARACTERISTICS (continued)**

**Isolation distance:**

. The distance between the contacts is greater than 5.5 mm with the handle in the open position.  
. The DX<sup>3</sup> STOP ARC is suitable for isolation in accordance with standard EN/IEC 61009-1.

**Insulation voltage:**

. U<sub>i</sub> = 400 V in accordance with standard EN/IEC 61009-1

**Degree of pollution:**

. 2 in accordance with standard EN/IEC 61009-1.

**Dielectric strength:**

. 2,000 V

**Rated impulse withstand voltage:**

. U<sub>imp</sub> = 4 kV

**Degree or class of protection:**

. Terminals protected against direct contact, class of protection against solid objects and liquids (wired device): IP20 in accordance with standards IEC 529 / EN 60529 and NF 20-010  
. Front side protected against direct contact: IP40  
. Class II in relation to metallic conductive parts  
. Class of protection against mechanical impacts IK02 in accordance with standard EN 62262.

**Plastic materials:**

. Polyamide and P.B.T.

**Enclosure heat and fire resistance:**

. Resistance to glow wire tests at 960°C, in accordance with standard EN/IEC 61009-1  
. Classification V2, in accordance with standard UL94

**Higher heating potential:**

. The heat potential is assessed at: 3.4MJ

**Closing and opening force via the handle:**

. 5 N on opening  
. 14 N on closing

**Mechanical endurance:**

. Compliant with standard EN/IEC 61009-1 & EN/IEC 62606  
. Tested with 20,000 operations with no load

**Electrical endurance:**

. Compliant with standard EN/IEC 61009-1 & EN/IEC 62606  
. Tested with 10,000 operations with load (at I<sub>n</sub> x Cos  $\phi$  0.9)

**Sinusoidal vibration resistance (in accordance with IEC 68.2.6):**

. Axes: x – y – z  
. Frequency: 10 to 55 Hz  
. Acceleration: 3g (1g = 9.81 m.s<sup>-2</sup>)

**Resistance to tremors:**

. In accordance with standard NF EN 61009-1

**Ambient temperature:**

. Operation: from - 25°C to + 40°C  
. Storage: from - 25°C to + 70°C

**Phase + Neutral, neutral on left side****5. GENERAL CHARACTERISTICS** *(continued)***EMC Compatibility:**

The design of DX<sup>3</sup> STOP ARC with its intelligent signal analysis of the power grid avoids any interference with PLC signal.

Tests according to IEC 61000 guarantee electromagnetic compatibility with other devices on the power grid.

**Packaged volume:**

Packaging	Volume (dm <sup>3</sup> )
Per 1	0.52

**Average unit weight per catalogue number:**

. 0.3 kg

**Derating of DX<sup>3</sup> STOP ARC function of the number of devices placed side by side:**

When several RCBOs are installed side by side and operate simultaneously, the heat dissipation of one pole is limited. This results in an increased operating temperature for RCBOs which may cause false tripping. Applying the following coefficients to the operating currents is recommended.

Number of RCBOs side by side	Coefficient
2 - 3	0.9
4 - 5	0.8
6 - 9	0.7
≥ 10	0.6

These values are provided by recommendation IEC 60439-1 and the standards NF C 63421 and EN 60439-1.

In order to avoid having to use these coefficients there must be good ventilation and the devices must be kept apart using the spacing elements Cat. No. 4 063 07 (0.5 module).

**Derating of DX<sup>3</sup> STOP ARC in the event of use with fluorescent tubes:**

LEDs and electronic or ferromagnetic ballasts provide a high inrush current for a very short time. These currents are liable to cause tripping of the RCBOs.

The maximum number of ballasts per RCBO stated by the lamp and ballast manufacturers in their catalogues should be taken into account during installation.

**Impact of height:**

	≤ 2000 m	3,000 m	4,000 m	5,000 m
Dielectric strength	2,000 V	1,750 V	1,500 V	1,250 V
Maximum operating voltage	230 V	230 V	230 V	230 V
Derating at 30°C	none	none	none	none

**Dissipated power (W):**

. with In/Un

Rated current	10 A	16 A	20 A
Power (W) dissipated	3.4	6.6	8.3

## Phase + Neutral, neutral on left side

5. GENERAL CHARACTERISTICS *(continued)***Derating of DX<sup>3</sup> STOP ARC depending on the ambient temperature:**

. The nominal characteristics of a circuit breaker are modified depending on the ambient temperature which prevails in the cabinet or enclosure where the DX<sup>3</sup> STOP ARC is located.

. Reference temperature: 30°C in accordance with standard EN/IEC 61009-1.

In (A)	- 25 °C	- 10 °C	0 °C	10 °C	20 °C	30 °C	40 °C	50 °C	60 °C	70 °C
10	12.5	12	11.5	11	10.5	10	9.5	9	8.5	8
16	20	19.2	18.4	17.6	16.8	16	15.2	14.4	13.6	12.8
20	25	24	23	22	21	20	19	18	17	16

**Specific use:**

. Appropriate to operate in humid atmosphere and polluted by a chlorinated environment (pool-type)

**Association and coordination of an RCBO with a protective device located upstream**

This association allows a device's breaking capacity to be increased by combining it with another protective device placed upstream.

This combination makes it possible to use a downstream device with a breaking capacity which is lower than the maximum prospective short-circuit current at its installation point.

**Association and coordination with upstream fuses:**

. Three-phase network (+N) 230/400 V or 240/415 V in accordance with standard IEC 60947-2

. TT neutral earthing or TNS system

Downstream RCBO Ph+N		Upstream fuse									
		gG and aM types									
		≤20 A	25 A	32 A	40 A	50 A	63 A	80 A	100 A	125 A	160 A
DX <sup>3</sup> STOP ARC 6000 A C curve	10 A	50 kA	50 kA	50 kA	50 kA	50 kA	25 kA	25 kA	25 kA	25 kA	25 kA
	16 A	50 kA	50 kA	50 kA	50 kA	50 kA	25 kA	25 kA	25 kA	25 kA	25 kA
	20 A	-	50 kA	50 kA	50 kA	50 kA	25 kA	25 kA	25 kA	25 kA	25 kA

**Association and coordination with upstream MCBs:**

. Three-phase network (+N) 230/400 V or 240/415 V in accordance with standard IEC 60947-2

. TT neutral earthing or TNS system

Downstream RCBO Ph+N		Upstream MCB								
		DX <sup>3</sup> 10000 / 16kA								
		C and D curves								
		≤ 25 A	32 A	40 A	50 A	63 A	80 A	100 A	125 A	
DX <sup>3</sup> STOP ARC 6000 A C curve	10 A	32 kA	32 kA	25 kA	25 kA	25 kA	25 kA	25 kA	25 kA	
	16 A	32 kA	32 kA	25 kA	25 kA	25 kA	25 kA	25 kA	25 kA	
	20 A	32 kA	32 kA	25 kA	25 kA	25 kA	25 kA	25 kA	25 kA	

## Phase + Neutral, neutral on left side

5. GENERAL CHARACTERISTICS *(continued)***Association and coordination with upstream MCBs:**

- . Three-phase network (+N) 230/400 V or 240/415 V in accordance with standard IEC 60947-2
- . TT neutral earthing or TNS system

		Upstream MCB							
		DX <sup>3</sup> 25 kA C and D curves							
Downstream RCBO Ph+N		≤ 25 A	32 A	40 A	50 A	63 A	80 A	100 A	125 A
DX <sup>3</sup> STOP ARC 6000 A C curve	10 A	50 kA	50 kA	25 kA	25 kA	25 kA	25 kA	25 kA	25 kA
	16 A	50 kA	50 kA	25 kA	25 kA	25 kA	25 kA	25 kA	25 kA
	20 A	50 kA	50 kA	25 kA	25 kA	25 kA	25 kA	25 kA	25 kA

		Upstream MCB					
		DX <sup>3</sup> 36 kA C curve					
Downstream RCBO Ph+N		≤ 25 A	32 A	40 A	50 A	63 A	80 A
DX <sup>3</sup> STOP ARC 6000 A C curve	10 A	50 kA	50 kA	50 kA	50 kA	50 kA	50 kA
	16 A	50 kA	50 kA	50 kA	50 kA	50 kA	50 kA
	20 A	50 kA	50 kA	50 kA	50 kA	50 kA	50 kA

## Phase + Neutral, neutral on left side

## 5. GENERAL CHARACTERISTICS (continued)

## Association and coordination with upstream MCBs:

- . Three-phase network (+N) 230/400 V or 240/415 V in accordance with standard IEC 60947-2
- . TT neutral earthing or TNS system

		Upstream MCB									
		DX <sup>3</sup> 50 kA C curves					DX <sup>3</sup> 50 kA D curve				
Downstream RCBO Ph+N		≤ 25 A	32 A	40 A	50 A	63 A	≤ 25 A	32 A	40 A	50 A	63 A
DX <sup>3</sup> STOP ARC 6000 A C curve	10 A	50 kA	50 kA	50 kA	50 kA	50 kA	50 kA	50 kA	50 kA	50 kA	50 kA
	16 A	50 kA	50 kA	50 kA	50 kA	50 kA	50 kA	50 kA	50 kA	50 kA	50 kA
	20 A	50 kA	50 kA	50 kA	50 kA	50 kA	50 kA	50 kA	50 kA	50 kA	50 kA

## Association and coordination with upstream Moulded Case Circuit Breakers (MCCBs):

- . Three-phase network (+N) 230/400 V or 240/415 V in accordance with standard IEC 60947-2
- . TT neutral earthing or TNS system

		Upstream MCCB								
		DPX <sup>3</sup> 160 16 kA								
Downstream RCBO Ph+N		16 A	25 A	40 A	63 A	80 A	100 A	125 A	160 A	
DX <sup>3</sup> STOP ARC 6000 A C curve	10 A	22 kA	22 kA	22 kA	22 kA	22 kA	22 kA	22 kA	22 kA	
	16 A	-	22 kA	22 kA	22 kA	22 kA	22 kA	22 kA	22 kA	
	20 A	-	22 kA	22 kA	22 kA	22 kA	22 kA	22 kA	22 kA	

		Upstream MCCB								
		DPX <sup>3</sup> 160 25 kA / 36 kA & 50 kA								
Downstream RCBO Ph+N		16 A	25 A	40 A	63 A	80 A	100 A	125 A	160 A	
DX <sup>3</sup> STOP ARC 6000 A C curve	10 A	30 kA	30 kA	30 kA	30 kA	30 kA	30 kA	30 kA	30 kA	
	16 A	-	30 kA	30 kA	30 kA	30 kA	30 kA	30 kA	30 kA	
	20 A	-	30 kA	30 kA	30 kA	30 kA	30 kA	30 kA	30 kA	

## Phase + Neutral, neutral on left side

## 5. CARACTERISTIQUES GENERALES (suite)

## Association and coordination with upstream Moulded Case Circuit Breakers (MCCBs):

- . Three-phase network (+N) 230/400 V or 240/415 V in accordance with standard IEC 60947-2
- . TT neutral earthing or TNS system

		Upstream MCCB							
		DPX <sup>3</sup> 250 ≤ 70 kA thermal-magnetic				DPX <sup>3</sup> 250 ≤ 70 kA electronic			
Downstream RCBO Ph+N		100 A	160 A	200 A	250 A	40 A	100 A	160 A	250 A
DX <sup>3</sup> STOP ARC 6000 A C curve	10 A	30 kA	30 kA	30 kA	30 kA	30 kA	30 kA	30 kA	30 kA
	16 A	30 kA	30 kA	30 kA	30 kA	30 kA	30 kA	30 kA	30 kA
	20 A	30 kA	30 kA	30 kA	30 kA	30 kA	30 kA	30 kA	30 kA

		Upstream MCCB									
		DPX <sup>3</sup> 250 ≤ 70 kA thermal-magnetic					DPX <sup>3</sup> 250 ≤ 70 kA electronic				
Downstream RCBO Ph+N		25 A	40 A	63 A	100 A	160 A	250 A	40 A	100 A	160 A	250 A
DX <sup>3</sup> STOP ARC 6000 A C curve	10 A	30 kA	30 kA	30 kA	30 kA	30 kA	30 kA	30 kA	30 kA	30 kA	30 kA
	16 A	30 kA	30 kA	30 kA	30 kA	30 kA	30 kA	30 kA	30 kA	30 kA	30 kA
	20 A	30 kA	30 kA	30 kA	30 kA	30 kA	30 kA	30 kA	30 kA	30 kA	30 kA



## Phase + Neutral, neutral on left side

## 5. CARACTERISTIQUES GENERALES (suite)

**Association and coordination with upstream Moulded Case Circuit Breakers (MCCBs):**

- . Three-phase network (+N) 240/415 V or 240/415 V in accordance with standard IEC 60947-2
- . TT neutral earthing or TNS system

		Upstream MCCB				
		DPX <sup>3</sup> 630 ≤ 100kA thermal-magnetic / electronic				
Downstream RCBO Ph+N		250 A	320 A	400 A	500 A	630 A
DX <sup>3</sup> STOP ARC 6000 A C curve	10 A	25 kA	25 kA	25 kA	25 kA	25 kA
	16 A	25 kA	25 kA	25 kA	25 kA	25 kA
	20 A	25 kA	25 kA	25 kA	25 kA	25 kA

		Upstream MCCB	
		DPX <sup>3</sup> 1600 ≤ 100kA thermal magnetic	DPX <sup>3</sup> 1600 ≤ 100kA electronic
Downstream RCBO Ph+N		630 A to 1250 A	630 A to 1600 A
DX <sup>3</sup> STOP ARC 6000 A C curve	10 A	25 kA	25 kA
	16 A	25 kA	25 kA
	20 A	25 kA	25 kA

**Selectivity between two levels of protection**

- . The downstream RCBO must always have a magnetic threshold and a rated current lower than those of the upstream protection.
- . Selectivity or Discrimination is said to be total (T) if there is discrimination up to the value of breaking capacity (in accordance standard with IEC 60947-2) of the downstream RCBO.

## Phase + Neutral, neutral on left side

## 5. CARACTERISTIQUES GENERALES (suite)

## Discrimination with upstream fuses:

. Discrimination limit with a voltage of 230 V ~ (Values in A)

		Upstream fuse cartridge							
		gG cartridge							
Downstream RCBO Ph+N		32 A	40 A	50 A	63 A	80 A	100 A	125 A	160 A
DX <sup>3</sup> STOP ARC 6000 A C curve	10 A	-	1600	2200	3200	3600	7000	T	T
	16 A	-	1400	1800	2600	3000	5600	8000	T
	20 A	-	1200	1500	2200	2500	4600	6300	10000

		Upstream fuse cartridge								
		aM cartridge								
Downstream RCBO Ph+N		25 A	32 A	40 A	50 A	63 A	80 A	100 A	125 A	160 A
DX <sup>3</sup> STOP ARC 6000 A C curve	10 A	-	1100	1700	2500	5000	7800	T	T	T
	16 A	-	1000	1400	2100	4000	6000	9000	T	T
	20 A	-	-	1300	1800	3400	5100	7000	T	T

. T = Total discrimination

## Phase + Neutral, neutral on left side

## 5. GENERAL CHARACTERISTICS (continued)

## Discrimination with upstream modular MCBs:

Discrimination limit with a voltage of 230 V ~ (Values in A)

		Upstream MCB											
		DX <sup>3</sup> 10000 A C curve											
Downstream RCBO Ph+N		10 A	13 A	16 A	20 A	25 A	32 A	40 A	50 A	63 A	80 A	100 A	125 A
DX <sup>3</sup> STOP ARC 6000 A C curve	10 A	-	98	120	150	187	240	300	375	472	3000	5000*	T*
	16 A	-	-	-	150	187	240	300	375	472	2000	3600*	5500*
	20 A	-	-	-	-	187	240	300	375	472	1600	3000	4000*

		Upstream MCB											
		DX <sup>3</sup> 10000 A D curve											
Downstream RCBO Ph+N		10 A	13 A	16 A	20 A	25 A	32 A	40 A	50 A	63 A	80 A	100 A	125 A
DX <sup>3</sup> STOP ARC 6000 A C curve	10 A	-	-	192	240	300	384	480	600	756	3000	5000	T
	16 A	-	-	-	240	300	384	480	600	756	2000	3600	5500
	20 A	-	-	-	-	300	384	480	600	756	1600	3000	4000

. T = Total discrimination

. \*: If the discrimination value stated in the table is greater than the breaking capacity of the upstream RCBO then the breaking capacity of the upstream device must be taken as the discrimination value (the discrimination value may not exceed the breaking capacity of the upstream device).

## Phase + Neutral, neutral on left side

## 5. GENERAL CHARACTERISTICS (continued)

## Discrimination with upstream modular MCBs:

. Discrimination limit with a voltage of 230 V ~ (Values in A)

		Upstream MCB										
		DX <sup>3</sup> 25 kA C curve										
Downstream RCBO Ph+N		10 A	16 A	20 A	25 A	32 A	40 A	50 A	63 A	80 A	100 A	125 A
DX <sup>3</sup> STOP ARC 6000 A C curve	10 A	-	120	150	187	500	700	1000	1800	3000	5000	T
	16 A	-	-	150	187	300	500	700	1300	2000	3600	5500
	20 A	-	-	-	187	300	400	500	1000	1600	3000	4000

		Upstream MCB										
		DX <sup>3</sup> 25 kA D curve										
Downstream RCBO Ph+N		10 A	16 A	20 A	25 A	32 A	40 A	50 A	63 A	80 A	100 A	125 A
DX <sup>3</sup> STOP ARC 6000 A C curve	10 A	-	192	240	300	500	700	1000	1800	3000	5000	T
	16 A	-	-	240	300	384	500	700	1300	2000	3600	5500
	20 A	-	-	-	300	384	480	600	1000	1600	3000	4000

. T = Total discrimination

## Phase + Neutral, neutral on left side

## 5. GENERAL CHARACTERISTICS (continued)

## Discrimination with upstream modular MCBs:

. Discrimination limit with a voltage of 230 V ~ (Values in A)

		Upstream MCB								
		DX <sup>3</sup> 50 kA C curve								
Downstream RCBO Ph+N		10 A	16 A	20 A	25 A	32 A	40 A	50 A	63 A	80 A
DX <sup>3</sup> STOP ARC 6000 A C curve	10 A	-	120	150	210	500	700	1000	1800	3000
	16 A	-	-	150	187	300	500	700	1300	2000
	20 A	-	-	-	187	300	400	500	1000	1600

		Upstream MCB								
		DX <sup>3</sup> 50 kA D curve								
Downstream RCBO Ph+N		10 A	16 A	20 A	25 A	32 A	40 A	50 A	63 A	
DX <sup>3</sup> STOP ARC 6000 A C curve	10 A	-	192	240	300	500	700	1000	1800	
	16 A	-	-	240	300	384	500	700	1300	
	20 A	-	-	-	300	384	480	600	1000	

## Discrimination with upstream MCCBs:

. Discrimination limit with a voltage of 230 V ~ (Values in A)

Downstream RCBO Ph+N	Upstream MCCB	
DX <sup>3</sup> STOP ARC 6000 A C curve	DPX <sup>3</sup> all models all ratings	DMX <sup>3</sup> all models all ratings
	T	T

. T = Total discrimination

**Phase + Neutral, neutral on left side****6. COMPLIANCE AND APPROVALS****In accordance with standard:**

- . IEC/EN 61009-1
- . IEC/EN 62606

**Usage in special conditions:**

- . Category C compliant (testing temperature range from -25°C to +70°C, resistant to salt spray) in accordance with the classification defined in Appendix Q of standard IEC 60947-1

**Respect for the environment – Compliance with European Union Directives:**

- . Compliance with Directive 2002/95/EC of 27/01/03 known as "RoHS" which provides for a restriction on the use of dangerous substances such as lead, mercury, cadmium, hexavalent chromium and polybrominated biphenyl (PBB) and polybrominated diphenyl ether (PBDE) brominated flame retardants from 1<sup>st</sup> July 2006
- . Compliance with the Directive 91/338/EEC of 18/06/91 and decree 94-647 of 27/07/04

**Plastic materials:**

- . Halogen free plastic materials.
- . Labelling of parts compliant with ISO 11469 and ISO 1043.

**Packaging:**

- . Design and manufacture of packaging compliant with decree 98-638 of 20/07/98 and Directive 94/62/EC

**7. CURVES**

Arc tripping time curve

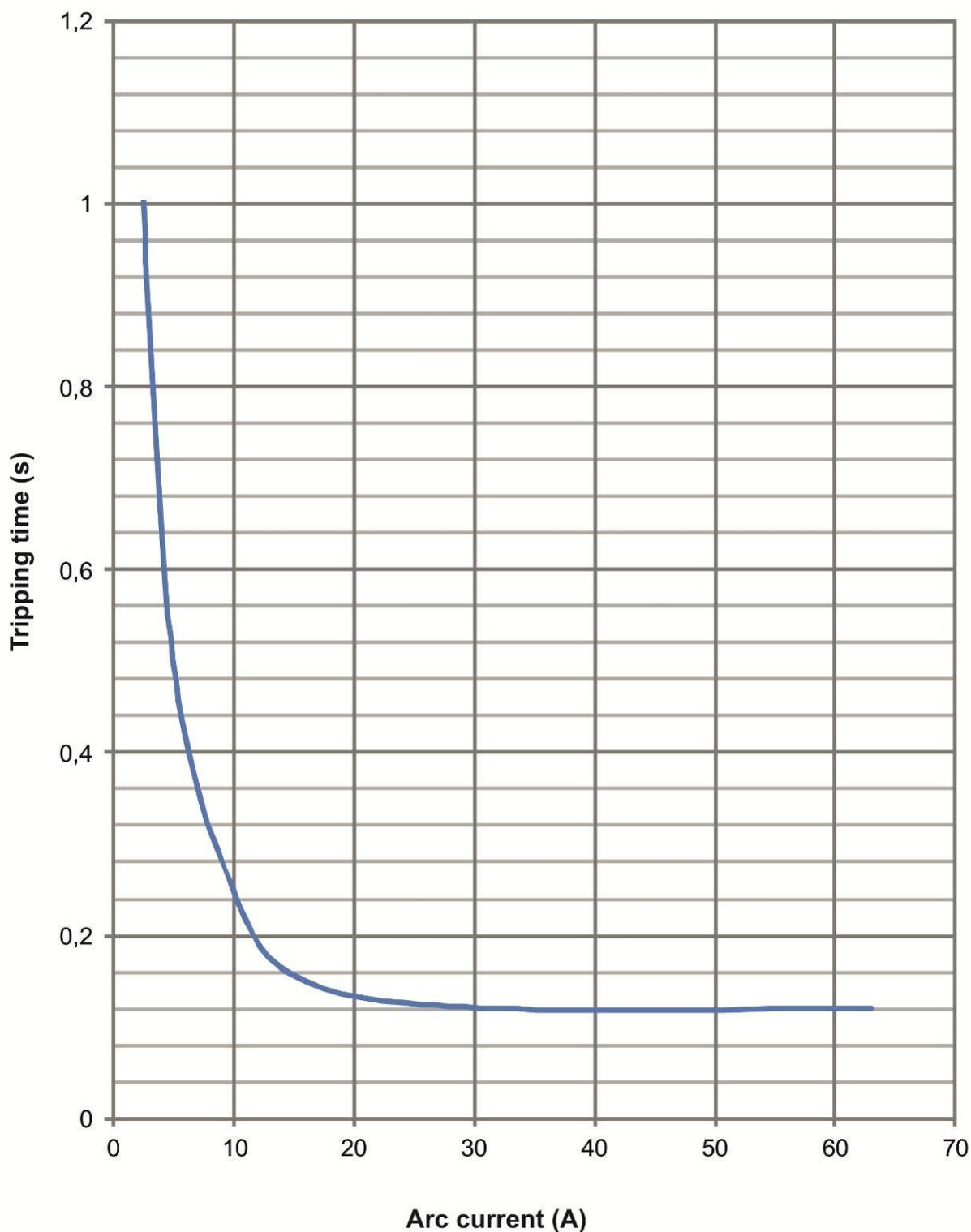

7. CURVES (continued)

Thermal-magnetic tripping range typical of C curve DX<sup>3</sup> STOP ARC:

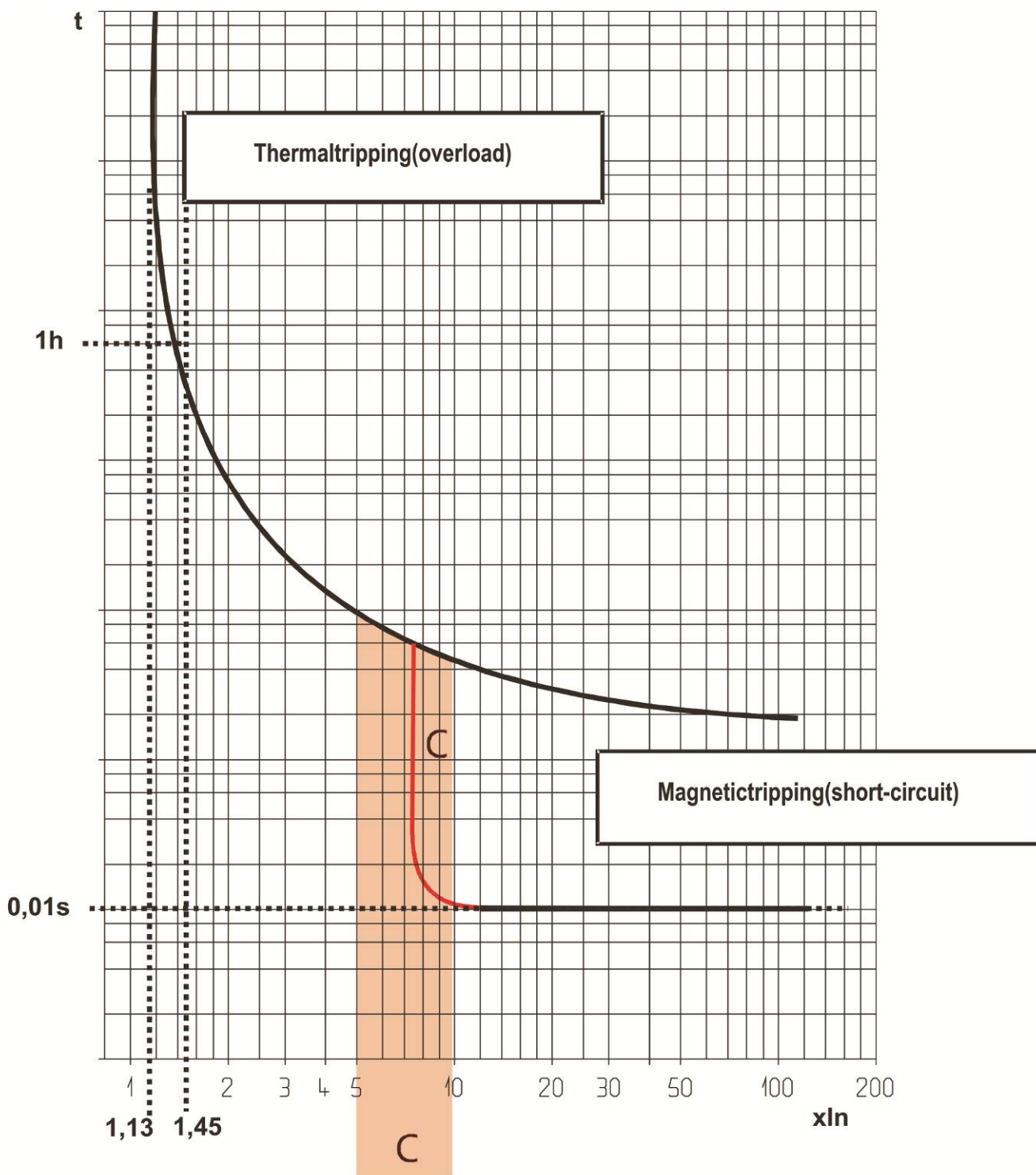

Thermal tripping at ambient temperature = 30°C  
 In = DX<sup>3</sup> STOP ARC rated current



**7. CURVES** *(continued)*

Average thermal-magnetic tripping curves range typical of C curve DX<sup>3</sup> STOP ARC:

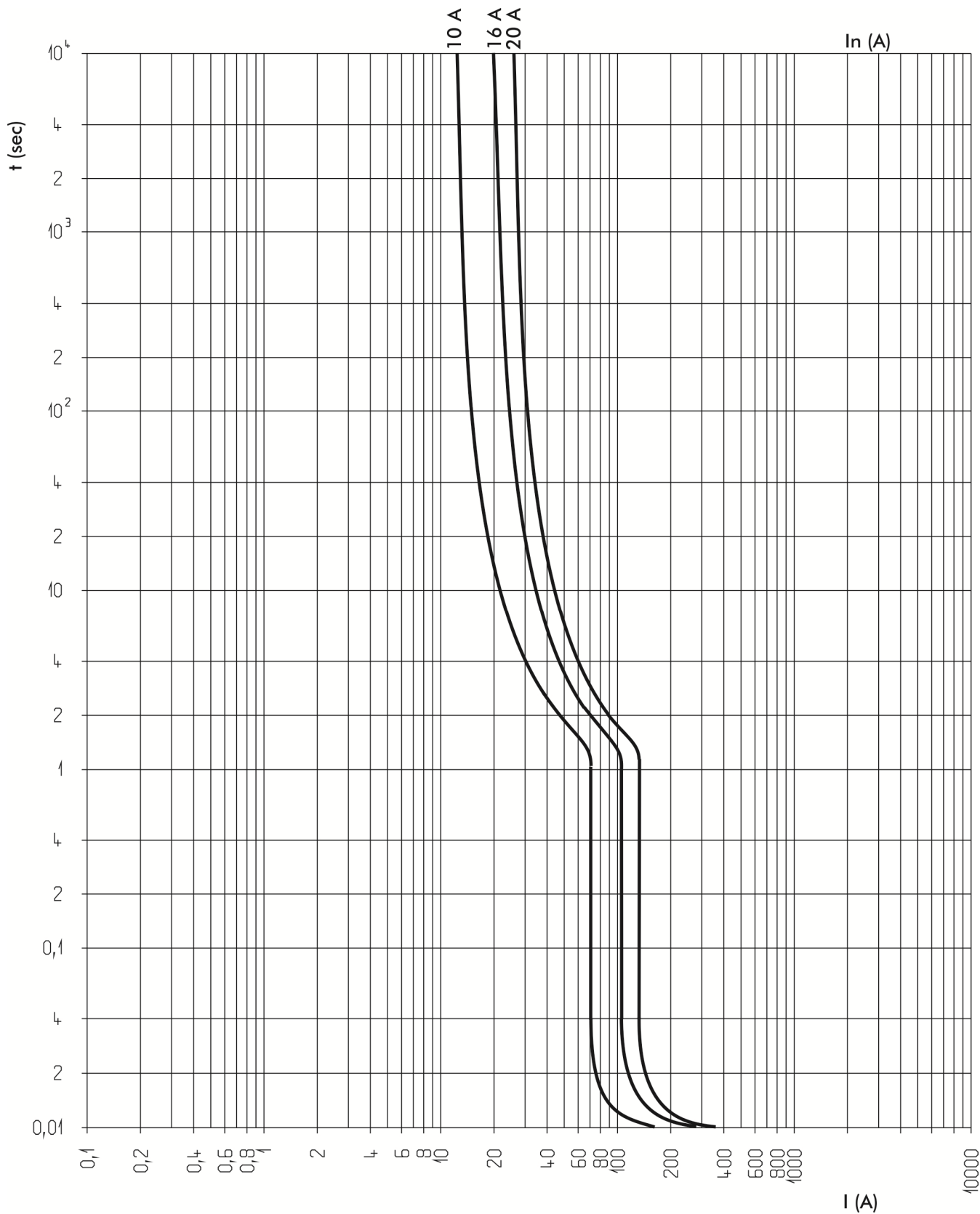

**Phase + Neutral, neutral on left side**

**7. CURVES (continued)**

**Current limiting curves:**

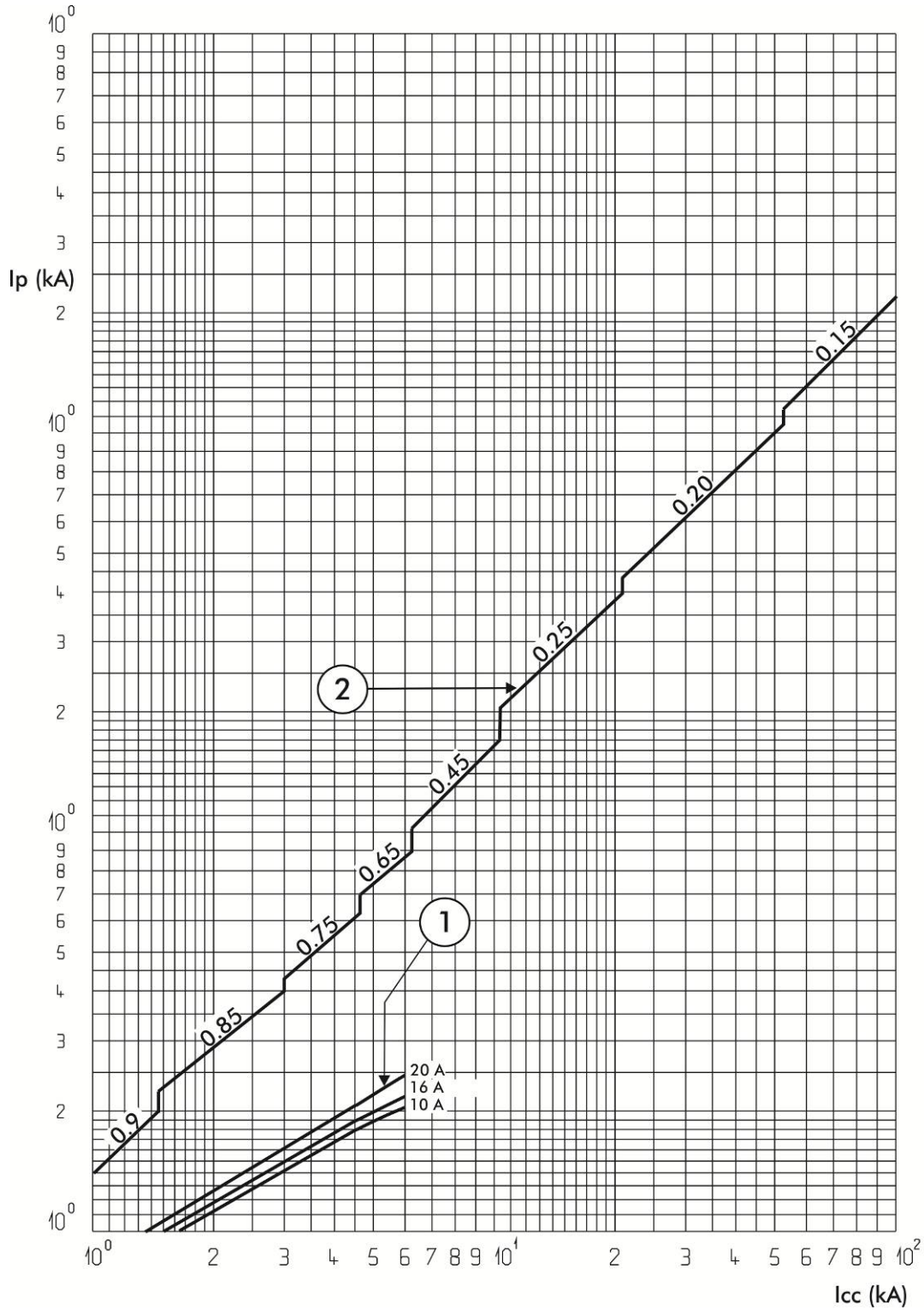

$I_{cc}$  = Prospective short-circuit symmetrical current (rms value in kA)  
 $I_p$  = Maximum peak value (in kA)  
 1 = Short-circuit rms currents (max. peak)  
 2 = Unlimited peak currents (max.), corresponding to power factors shown above (0.15 to 0.9)

**Phase + Neutral, neutral on left side**

**7. CURVES (continued)**

**Thermal stress limiting curves:**

. C curve RCBOs (230V/50Hz)

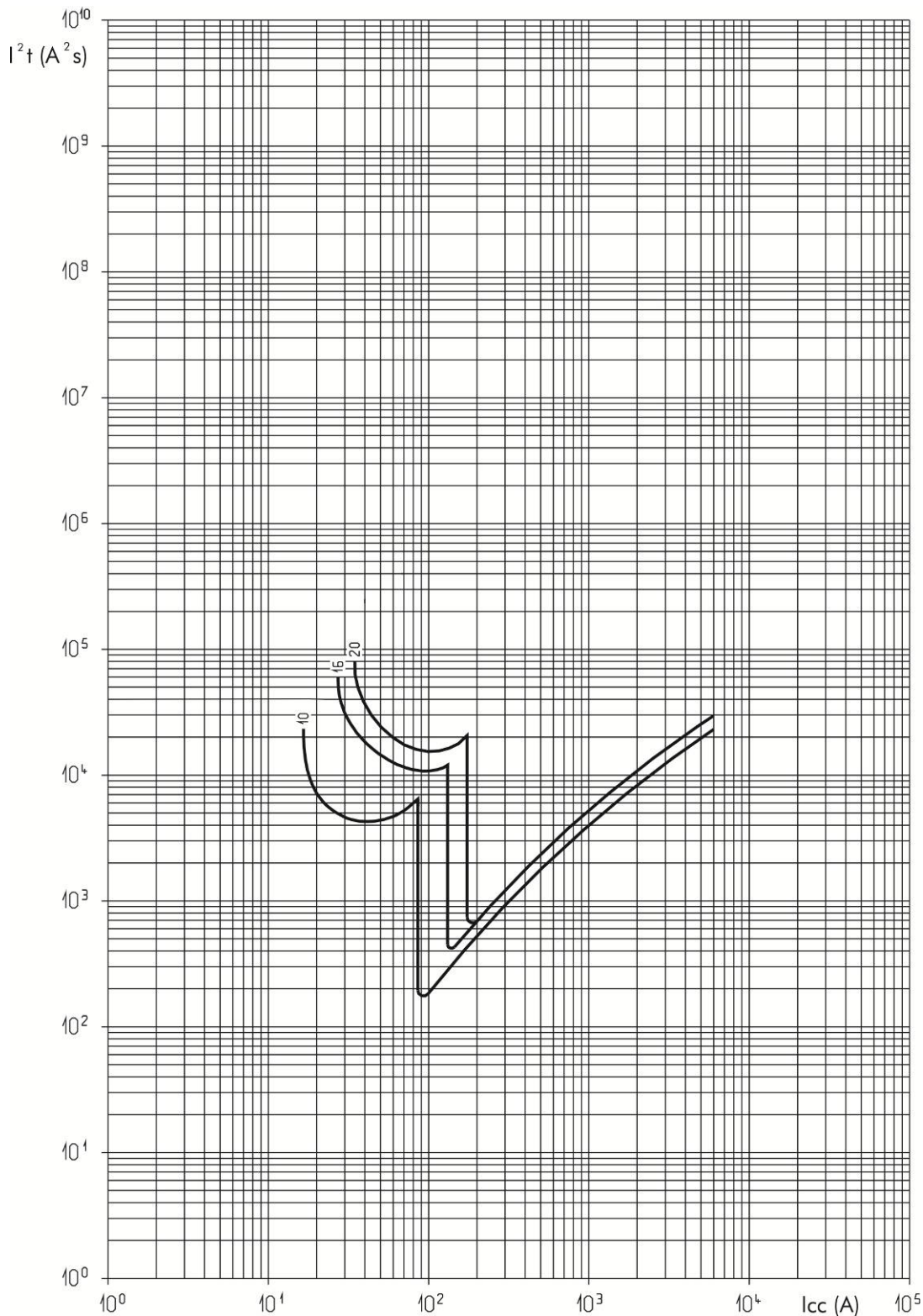

$I_{cc}$  = Prospective short-circuit symmetrical current (rms value in A)  
 $I^2t$  = Limited thermal stress (in  $A s^2$ )

## Phase + Neutral, neutral on left side

## 7. CURVES (continued)

## Tripping current curves:

. Tripping time curve depending on the value of the residual current:

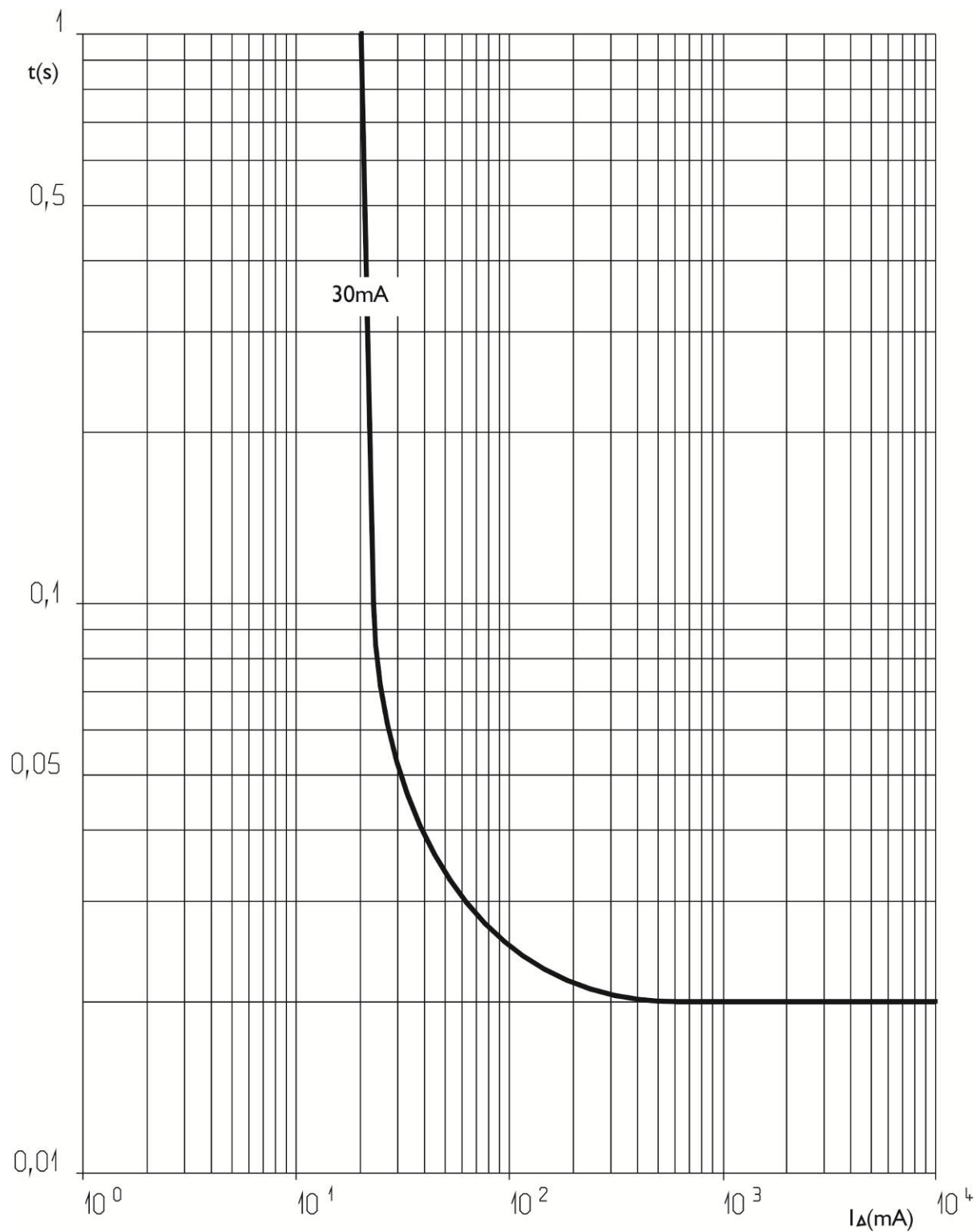

**Phase + Neutral, neutral on left side****8. AUXILIARIES AND ACCESSORIES****Wiring accessories:**

- . Supply busbar:
  - HX<sup>3</sup> single-pole universal supply busbar (Cat. No. 4 049 26 / 37)
- . Connection terminals (cat. No. 4 049 05)
- . Sealable screwcover (cat. No. 4 063 04)

**Signalling auxiliaries:**

- . Auxiliary contact (0.5 module, Cat. No. 4 062 58)
- . Fault signalling contact (0.5 module, Cat. No. 4 062 60)
- . Auxiliary contact that can be changed into fault signalling contact (0.5 module, Cat. No. 4 062 62)
- . Auxiliary contact + fault signalling contact that can be changed into 2 auxiliary contacts (1 module, Cat. No. 4 062 66)

**Control auxiliaries:****Only possible with a signalling auxiliary positioned between the control auxiliary and the DX<sup>3</sup> STOP ARC**

- . Shunt trip (1 module, Cat. No. 4 062 76 / 78)
- . Under voltage release (1 module, Cat. No. 4 062 80 / 82)
- . Autonomous shunt trip release for N/C push-button (1.5 module, Cat. No. 4 062 87)
- . Power Overvoltage Protection (1 module, Cat. No. 4 062 86)

**Possible combinations of auxiliaries and the DX<sup>3</sup> STOP ARC:**

- . The auxiliaries are installed to the left of the DX<sup>3</sup> STOP ARC
- . Maximum number of auxiliaries = 2
- . Maximum number of 1 module signalling auxiliaries = 1

**Locking options:**

- . Via padlock 5 mm in diameter (Cat. No. 4 063 13) or padlock 6 mm in diameter (Cat. No. 0 227 97) and padlock support (Cat. No. 4 063 03)

**Installation software:**

- . XL PRO<sup>3</sup>

**9. SAFETY:**

For your safety your electrical installation is equipped with residual current protection which must be tested periodically.

In the absence of any national regulations on the time period required for this, Legrand recommends that this test be carried out every month: press the "T" test button, the device should trip. Please call an electrician immediately if this does not happen as the safety level of your installation has been reduced.

The presence of residual current protection does not remove the need to observe all the precautions associated with using electrical energy.