



70 RT HP is a new range of 16A to 160A switch disconnectors in isolating material and metal, supplied in a box. Available in control and emergency versions, the range is completed by board versions for front-panel or DIN rail assembly, in 16 to 63A options, all of which can be equipped with auxiliary contacts. These devices have been designed to deliver the ultimate in reliability, functionality and performance. They offer a technologically advanced solution that simplifies installation, reduces wiring times and ensures maximum safety and robustness, even in the most demanding conditions, thanks to the use of high-performance materials.

Versiune	Doză	Material	Clasă
Tip	Comanda	Curent nominal (A)	80
Înterupător	Rotary izolator	Clasă de protecție IP	IP66/IP67/IP69
Cod IK	IK08	Temperatură ambientă	-25 +60 °C
Lid screws (no. and type)	4 sigilabile la 1/4 de tur	Intrare orificii	2 x M25/32 + 2 x M25/32
Blocabil	YES (max. 3 locks in ON and OFF)	Complet cu	Max. 2 auxiliary contacts
Current in AC22 (415V)	80	Current in AC23 (415V)	80
Secțiune cabluri	Max 25 mm ²	Dim. exterioare LxHxP (mm)	156x200x95
Electrocod	1742		



DIMENSIONAL

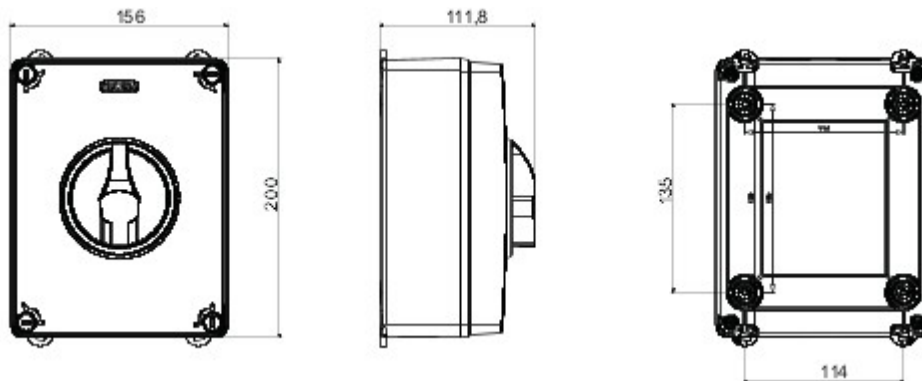

TECHNICAL SYMBOLOGY

IP

IP66/IP67/IP69

IK

IK08

STANDARDS/APPROVALS

