

19" modular fibre optic drawers

Cat.No(s) : 0 321 00/01/02/04/06 - 0321 10/11/12/13/14/15/16/17/18/19
 0 321 20/21/23/24/25/27 - 0 321 33/34/36/37 - On demand

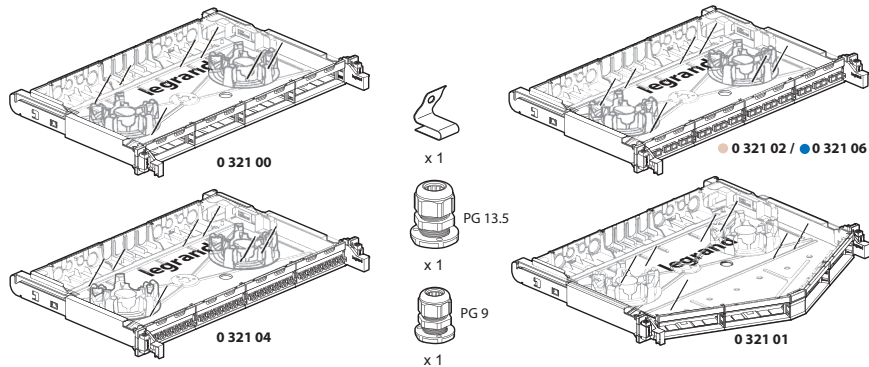

1. APPLICATION

Metal 19" modular fibre optic drawers, 8 cable entries, supplied with screw fixing kit, 2 cable glands (PG 9 and PG 13.5), 2 coiling kits. Equipped with the new-generation Soluclip system for automatic (screwless) fixing on rack or cabinet uprights. Supplied with identification labels. Sliding: end stop at a 20° angle for easier wiring. Universal mounting on all racks or cabinets with automatic earthing on unpainted uprights. Painted panels can be connected to earth with a cord and a claw connection.

2. RANGE

0 321 00	Empty drawer - Takes any modular fibre optic unit, up to four units maximum
0 321 01	Empty drawer - Takes any modular fibre optic unit, up to four units maximum
0 321 02	Equipped with SC units for 24 multimode optical fibres
0 321 04	Equipped with LC units for 48 multimode optical fibres
0 321 06	Equipped with SC units for 24 singlemode optical fibres

3. DRAWER DIMENSIONS (mm)

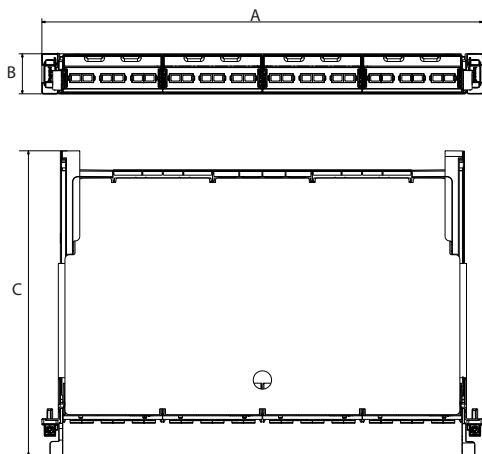

Cat. Nos.	A	B	C
0 321 00/02/04/06	482.5	43.8	334
0 321 01			408.6

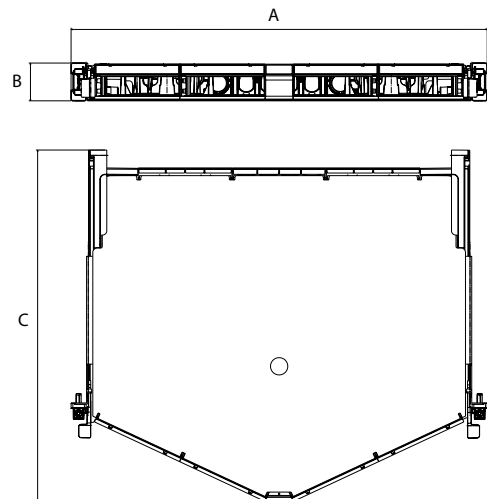



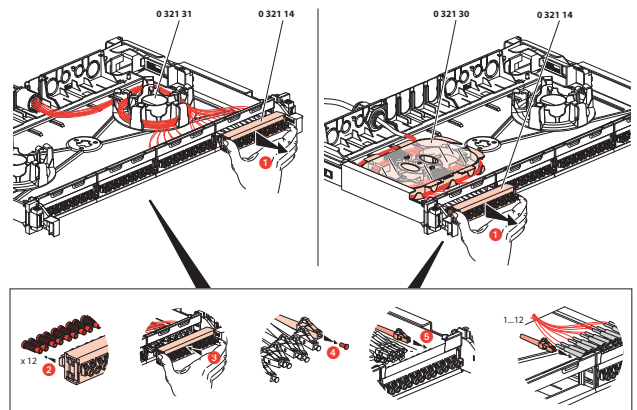



4. CONNECTION

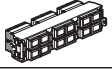
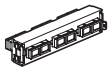

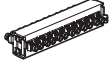
5. FIBRE OPTIC UNITS

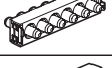
Fibre optic units are clipped directly on modular fibre optic drawer Cat. No. 0 321 00, on modular corner fibre optic drawer Cat. No. 0 321 01, and also on spliceable cassette Cat. No. 0 321 41.

	● 0 321 11	SC duplex HD - 12 singlemode fibres
	● 0 321 21	SC duplex HD - 12 multimode fibres
	● 0 321 10	SC duplex - 6 singlemode fibres
	● 0 321 12	SC/APC duplex - 6 singlemode fibres
	● 0 321 20	SC duplex - 6 multimode fibres
	● 0 321 13	LC duplex - 6 singlemode fibres
	● 0 321 23	LC duplex - 6 multimode fibres
	● 0 321 36	LC duplex - 6 multimode fibres (aqua)
	● 0 321 14	LC duplex - 12 singlemode fibres
	● 0 321 16	LC/APC duplex - 12 singlemode fibres
	● 0 321 24	LC duplex - 12 multimode fibres
	● 0 321 37	LC duplex - 12 multimode fibres (aqua)
	● 0 321 15	LC duplex HD - 24 singlemode fibres
	● 0 321 25	LC duplex HD - 24 multimode fibres
	● 0 321 17	ST for 6 singlemode fibres
	● 0 321 27	ST for 6 multimode fibres
	● 0 321 33	4 adaptor, feedthrough, singlemode MTPs
	● 0 321 34	4 adaptor, feedthrough, multimode MTPs
On demand		- 4 or 8 MTP adaptors multimode or singlemode key UP/key UP - 4 or 8 MTP adaptors OM5 key UP/key down - LC duplex for 6/12 or 24 fibres OM5 - SC duplex 6 or 12 fibres OM5

6. UNIT DIMENSIONS (mm)

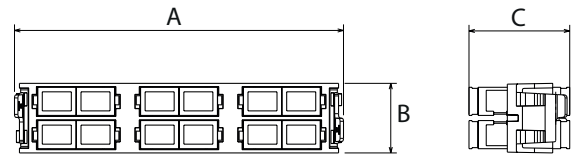

Cat. Nos.	A	B	C
0 321 10/11/12/20/21	108.8	23	33.3

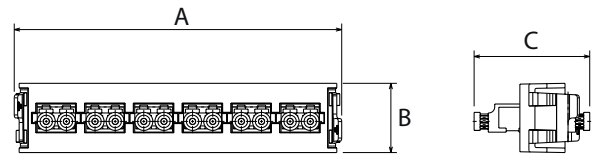

Cat. Nos.	A	B	C
0 321 13/14/15/16/23/24/25/36/37	108.8	23	38.4

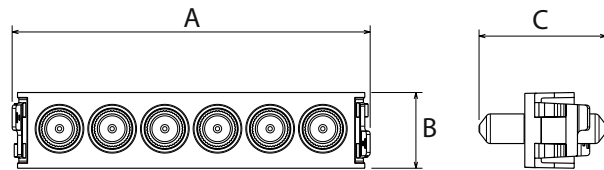

Cat. Nos.	A	B	C
0 321 17/27	108.8	23	38.7

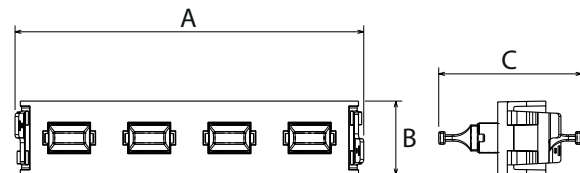

Cat. Nos.	A	B	C
0 321 18/19 - 0 321 33/34	108.8	23	44.7

7. TECHNICAL CHARACTERISTICS

7.1 Drawer characteristics

Depth: 285 mm, height 1 U

Maximum capacity:
96 LC connectors
48 SC connectors
24 ST connectors
32 MTP connectors

Supplied with screws and wiring accessories:
2 cable glands (1 x PG9/1 x PG13.5)
1 claw for earthing

In accordance with IEC 60297-3-100

7.2 Connector characteristics

SC Duplex adaptors :

- Singlemode (UPC : blue, APC : green) or multimode (aqua)
- "Push-pull" latch type locking
- Unibody plastic part
- Ceramic sleeve
- Metallic clamping clips
- Durability : 500 insertions
- Maximum insertion loss increase: 0.2dB
- In accordance with IEC 61754-4, IEC 60784-14, TIA-604-3

LC Duplex adaptors:

- Singlemode (UPC : blue, APC : green) or multimode (aqua)
- High density
- Tab locking
- Unibody plastic part
- Ceramic sleeve
- Metallic clamping clips
- Durability : 500 insertions
- Maximum insertion loss increase: 0.2dB
- In accordance with IEC 61754-20, TIA-604-10

ST Simplex adaptors:

- Singlemode (red cap) or multimode (black cap)
- Locked by "push and turn" bayonet type connector
- Metallic part
- Ceramic sleeve
- Tightening screw clamping
- Durability : 500 insertions
- Maximum insertion loss increase: 0.2dB
- In accordance with IEC 61754-2, TIA-604-2

MTP/MPO adapters:

- Singlemode (green) or multimode (beige)
- "Push-pull" latch type locking
- Unibody plastic part
- Metallic clamping clips
- Opposite key (Key up/Key down) or aligned (Key up/Key up)
- Adapted to Datacenters' high density
- In accordance with IEC 61754-7, TIA-604-5, TIA-604-18

Protection class: IP 20

Impact strength: IK 04

7.3 Climate characteristics

Storage and usage temperature: - 10°C to + 60°C

7.4 Standards Conformance

All parts ensure conformity to the following standards:
ISO/IEC 11801, EN 50173, ANSI/TIA 568

8. ACCESSORIES FOR FIBRE OPTIC DRAWER

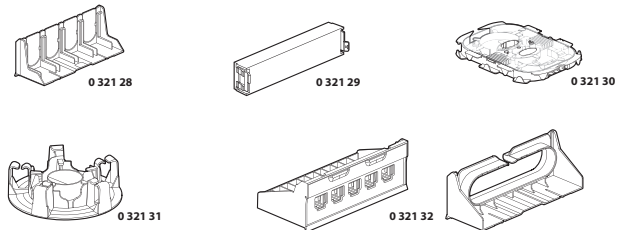

8.1 Fanout accessory for pretermination Cat. No. 0 321 28

This clips onto the back of the drawer and allows entry of the preterminations by fixing fanouts to the 4 knockout cable entries.

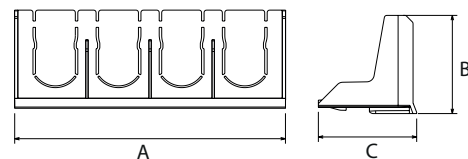

8.2 Blanking plate

Cat. No. 0 321 29

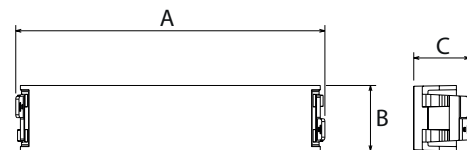

8.3 Cassette for pigtails

Cat. No. 0 321 30

Capacity: 24 fibres

In the drawer : Up to 2 cassettes, one on top of the other (fixing clip)

- Splice holder function
- Coiling fibres internally, and the cables on the surroundings
- Double-sided adhesives for clamping instead of coiling kits if needed

ABS plastic

Weight: 81 g

Operating temperature: -40°C to +50°C

Standard: ANSI/TIA 568.C

ISO/IEC 11801, EN 50173

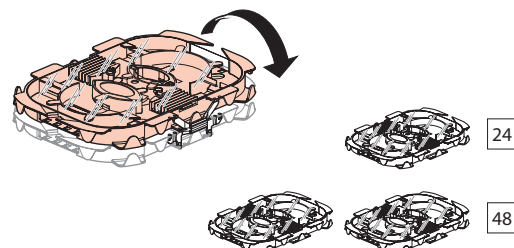
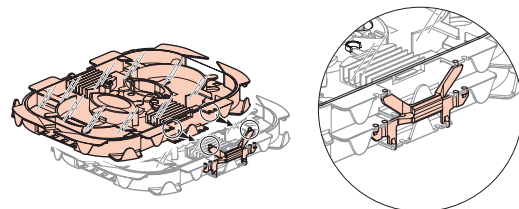

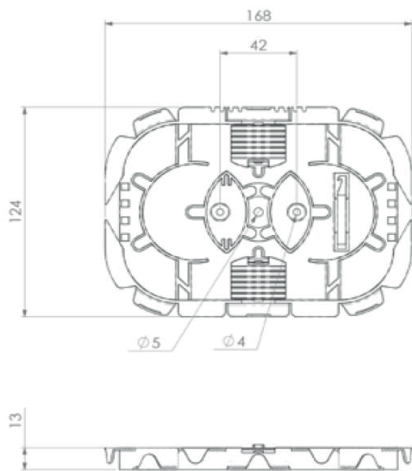

8.4 Coiling kit

Cat. No. 0 321 31

The 2 coiling kits clip directly onto modular fibre optic drawer Cat. No. 0 321 00.

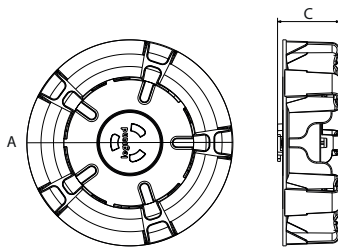

8.5 Copper unit

Cat. No. 0 321 32

This clips directly onto modular fibre optic drawers: Cat. Nos. 0321 00/01/02/04/06; it can be used to mix optical fibre and copper and up to 5 Cat 5e, Cat 6, Cat 6A and Cat 8 LCS3 RJ45 connectors per unit. Supplied with coloured labels.

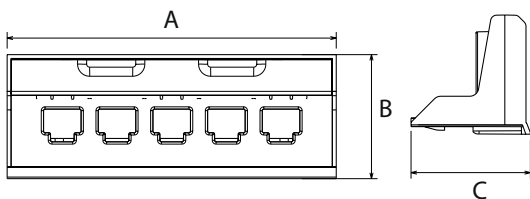

Cat. Nos.	A	B	C
0 32128	108.7	39.4	39.5
0 321 29	108.8	23	19.7
0 321 30	168	13	124
0 321 31	Ø 109		32.8
0 321 32	108.8	41	39.5

10. MADE-TO-ORDER PRODUCTS

Legrand's special service offers made-to-order products:

- LC duplex block for 6/12 or 24 OM5 fibres : Lime colour block, Beige LC feedthrough
- SC duplex block for 6 or 12 OM5 fibres : Lime colour block, Beige SC feedthrough
- Block 4 or 8 MTP adaptor OM5 key UP/key down: black block, Lime MTP feedthrough
- Block 4 or 8 MTP multimode or singlemode adaptor key UP/key UP : black block, grey MTP feedthrough

See the different options in the above tables

Please consult your distributor or your local sales office.