

# Motor driven remote control module DX<sup>3</sup>

Cat N°: 4 062 90 / 91 / 92



| CONTENTS                            | PAGE |
|-------------------------------------|------|
| 1. Description - Use .....          | 1    |
| 2. Product range .....              | 1    |
| 3. Overall dimensions .....         | 1    |
| 4. Preparation - Connection .....   | 2    |
| 5. General characteristics .....    | 3    |
| 6. Compliance and approvals.....    | 5    |
| 7. Auxiliaries and accessories..... | 5    |

## 1. DESCRIPTION - USE

This remote control can be associated to Legrand MCBs, RCBOs RCCBs and Remote trip isolating switches.  
 This remote control allows to open and close the associated device

### Technology :

- . DC electric motor with permanent magnets

## 2. PRODUCT RANGE

### Cat. Nos 4 062 90 / 91:

- . Standard Motor driven control unit for devices 1 module / pole width
- . Width = 1 module (17,7 mm)

### Cat. No 4 062 92:

- . Standard Motor driven control unit for devices 1,5 modules / pole width
- . Width = 2 modules (35,4 mm)

### Rated Voltage & Frequency:

- . 4 062 90  
 24÷48 V ~ 50 / 60 Hz with standard tolerances.  
 24÷48 V d.c current
- . 4 062 91 / 92  
 230 V ~ - 50 / 60 Hz with standard tolerances.  
 230 V d.c current

### Operating voltages:

- . 4 062 90  
 . Min (0,85 x Un): 20,4 V  
 . Max (1,1 x Un): 52,8 V
- . 4 062 91 / 92  
 . Min (0,85 x Un): 195,5 V  
 . Max (1,1 x Un): 253 V

## 3. OVERALL DIMENSIONS

### . 4 062 90 / 91

This device is fitted with a short handle for the 1 module wide associated devices (1P or 1P+N).

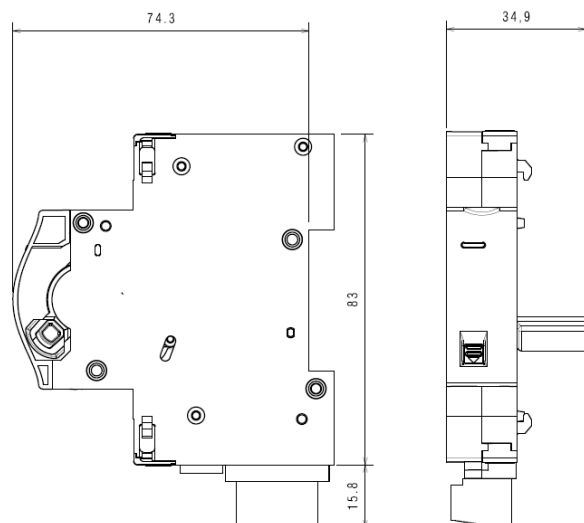

This device is delivered with an extension handle that must be used when it is associated to a devices wider than 1 module such as 2P, 3P, 3P+N, 4P modular devices.

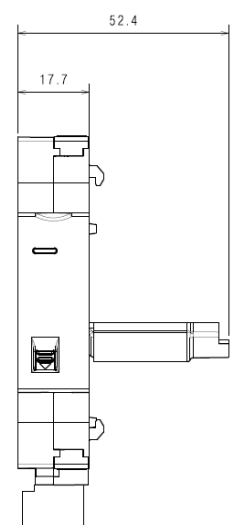

# Motor driven remote control module DX<sup>3</sup>

Cat N°: 4 062 90 / 91 / 92

## 3. OVERALL DIMENSIONS *(continued)*

. 4 062 92

Control module for associated devices of 1,5 modules / pole width  
(2P, 3P, 4P)

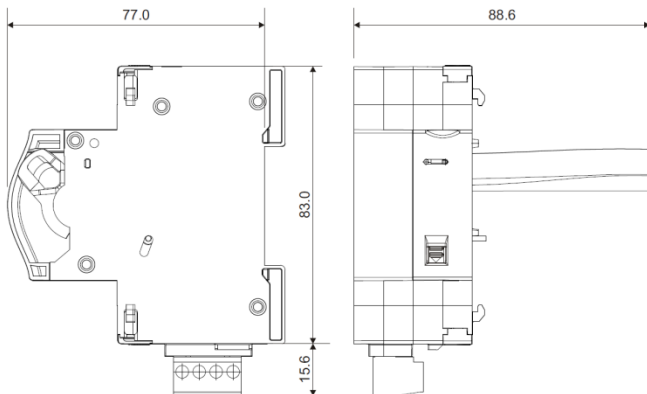

## 4. PREPARATION - CONNECTION

### Fixing:

. On symmetric rail EN/IEC 60715 or DIN 35.

### Operating positions:

. Vertical, Horizontal, backwards, on the side

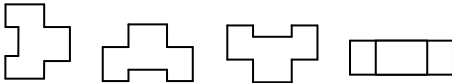

### Supply:

. From the bottom by the removable terminals.

### Association:

- . 4 062 90 / 91: On the left of MCBs (P+N, 1P, 2P, 3P and 4P, 1 module per pole wide), RCCBs, RCBOs and Remote trip isolating switches (up to 63A, 1 module per pole wide).
- . 4 062 92: On the left of MCBs (2P, 3P and 4P 1,5 modules per pole wide) and Remote trip isolating switches (up to 125A, 1,5 modules per pole wide).
- . No tool required. Clipped to the associated device by mean of plastic clamps.

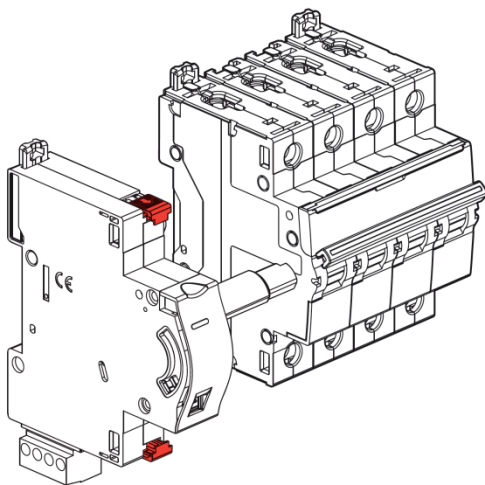

### Connection:

. Terminals protected against accidental contact (IP20, wired device).

## 4. PREPARATION - CONNECTION *(continued)*

### Depth of terminals:

. 10 mm.

### Connectable section:

|                | Copper cables                                      |  |
|----------------|--|--|
|                | Without ferrule                                    | With ferrule                                       |
| Rigid cable    | 1 x 2.5 mm <sup>2</sup><br>2 x 1.5 mm <sup>2</sup> | -  |
| Flexible cable | 1 x 2.5 mm <sup>2</sup><br>2 x 1.5 mm <sup>2</sup> | 1 x 2.5 mm <sup>2</sup><br>2 x 1.5 mm <sup>2</sup> |

### Stripping length recommended:

. 7 mm.

### Screw head:

. Slotted, diameter 3.5 mm.

### Recommended tightening torque:

. 0.4±0.5 Nm.

### Tools required:

- . For the terminals: flat screwdriver 3.5 mm.
- . For fixing: flat screwdriver 5.5 mm (6 mm maximum).

### Lockout:

- . By the sliding front face.
- . Sliding front face downward: the associated device goes into OFF position and manual or automatic closing operations are disabled.
- . Sliding front face upward: the device is operating.
- . Lockout by padlock  $\Phi$ 4mm only when the sliding front face is down. Then mechanical and electrical controls are not possible.

### Selector AUTO / MAN:

- . The selector enables and disables the automatic remote control.
- . Positions:
  - AUTO: possibility to automatically or manually control tripping and re-setting.
  - MAN: manual control only.
- . Signalling by LED:
  - Green fixed: associated device "power on" and "remote control" in AUTO mode.
  - Green flashing: remote control in MAN mode.

### Signalling:

- . Signalling by LED:
  - Green fixed: associated device "power on" and "remote control" in AUTO mode.
  - Green flashing: remote control in MAN mode.
  - Red fixed: the device has tripped on fault (overload, short-circuit, residual current fault) or by control auxiliary.
  - Sliding front face downward: LED switched-off

### Operating:

- . After tripping of the associated device, perform a manual re-closing or a re-closing by the motor driven control unit.

# Motor driven remote control module DX<sup>3</sup>

Cat N°: 4 062 90 / 91 / 92

## 4. PREPARATION - CONNECTION (continued)

### Control logics of the motor driven control unit:

. The device is fitted with an electronic card. The control pulse must be superior to 100ms. Only one pulse is sufficient for the command. The device can manage the following commands types:

- Control by push button (impulse):

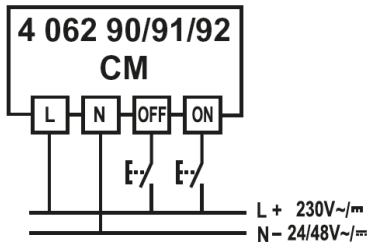

- Control by changeover switch (sustained voltage)

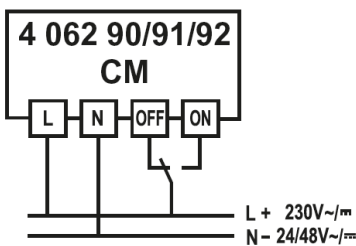

- Cyclic control by push-button (impulse)

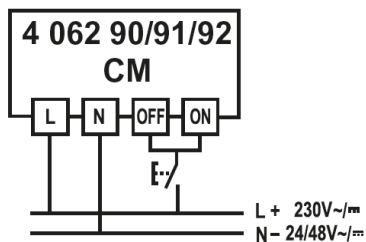

. The device doesn't execute any control operation in the following cases

- when controlled by a change-over switch (sustained voltage), if the associated device is manually operated or if it has tripped on default (overload, short-circuit, differential default or tripping by control auxiliary)

- when the power is turn on, the motor driven control module is controlled by a sustained executable control

- when controlled by a change-over switch (sustained voltage), if the selector AUTO / MAN moves from the MAN position to the AUTO position and if the sustained control is different from the status of the associated device.

. When controlled by a change-over switch (sustained voltage), it is necessary to wait for at least 1.5 seconds between two commands of the same type.

### Blocking of the device in case of tripping on default

Wiring diagram with fault signalling changeover switch "SD" to prevent the closing in case of fault trip (overload, short-circuit, residual current default or tripping by control auxiliary).

## 4. PREPARATION - CONNECTION (continued)

### Blocking of the control module in case of tripping on default

Wiring diagram with fault signalling changeover switch "SD" to prevent the closing in case of fault trip (overload, short-circuit, residual current default or tripping by control auxiliary).

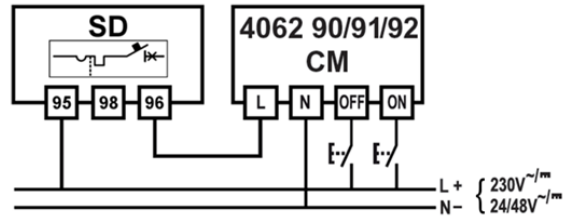

## 5. GENERAL CHARACTERISTICS

### Front side marking:

. By permanent pad printing

4 062 90      4 062 91      4 062 92

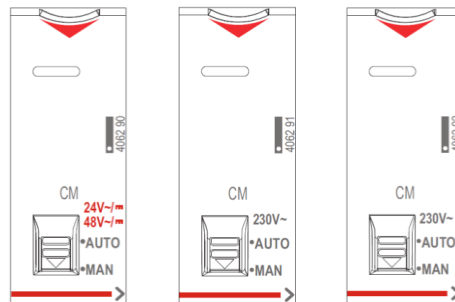

### Lateral side marking:

. By laser.

left side

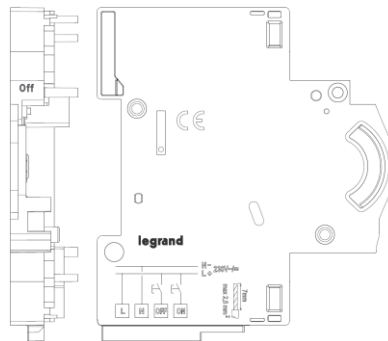

right side

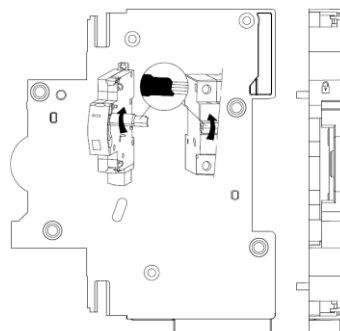

## 5. GENERAL CHARACTERISTICS *(continued)*

### Pulse rated voltage:

. U<sub>imp</sub> = 4 kV

### Insulation rated voltage:

. U<sub>i</sub> = 500 V

### Pollution degree :

. 2 according to IEC/EN 60898-1.

### Dielectric strength:

. 2500 V

### Mechanical endurance:

. 20000 operations.

### Electrical endurance:

. In accordance with the standard of the associated protection device.

### Switching frequency:

. 120 operations per hour (30 seconds between two operations)

### Enclosure material:

. 4 062 90 / 91 : Glass-fiber reinforced polycarbonate

. 4 062 92 : Polyamide

. Characteristics of this material: self extinguishing, heat and fire resistant according to EN 60898-1, glow-wire test at 960°C for external parts made of insulating material necessary to retain in position current-carrying parts and parts of protective circuit (650°C for all other external parts made of insulating material).

### Average weight per pole:

| Cat. No(s)    | Weight (kg) |
|---------------|-------------|
| 4 062 90 / 91 | 0,105       |
| 4 062 92      | 0,195       |

### Volume when packed :

| Cat. No(s)    | Volume (dm <sup>3</sup> ) |
|---------------|---------------------------|
| 4 062 90 / 91 | 0,99                      |
| 4 062 92      | 1,37                      |

### Ambient operating temperature:

. Min. = - 5 °C / Max. = + 60 °C.

### Ambient storage temperature:

. Min. = - 25 °C / Max. = + 60 °C.

### Protection class:

. Protection index of terminals against solid and liquid bodies:  
IP 20 (according to IEC 529, EN 60529 and NF C 20-010).

. Protection index of the case against solid and liquid bodies:  
IP 40 (according to IEC 529, EN 60529 and NF C 20-010).

### Resistance to sinusoidal vibrations:

. According to IEC 60068-2-6.

. Axis: x, y, z.

. Frequency range: 5 ÷ 100 Hz; duration 90 min.

. Displacement (5 ÷ 13.2 Hz): 1 mm

. Acceleration (13.2 ÷ 100 Hz): 0.7g (g = 9.81 m/s<sup>2</sup>).

< 1 s to complete the operation (opening and closing)

## 5. GENERAL CHARACTERISTICS *(continued)*

### Maximum activation time:

< 0.5 s to open or close contacts

### Maximum power consumption in closing:

. 4 062 90 :

24 Va.c.: 20VA rms for 0,7sec

48 Va.c.: 24VA rms for 0,7sec

24 Vd.c.: 17W for 0,7sec

48 Vd.c.: 7,5W for 0,7sec

. 4 062 91 :

230Va.c.: 20VA rms for 0,7sec

. 4 062 92 :

230 Va.c.: 88VA rms for 0,55sec

230 Vd.c.: 46W for 0.55sec

### Maximum power consumption in closing (peak):

. 4 062 90 :

24 Va.c.: 2A

48 Va.c.: 2,5A

24 Vd.c.: 1,5A

48 Vd.c.: 0,6A

. 4 062 91 :

230 Va.c.: 0,3A

. 4 062 92 :

230 Va.c.: 3,4A

230 Vd.c.: 0,5A

### Maximum power consumption in opening:

. 4 062 90 :

24 Va.c.: 25VA rms for 0,3sec

48 Va.c.: 32VA rms for 0,3sec

24 Vd.c.: 8,5W for 0,3sec

48 Vd.c.: 7W for 0,3sec

. 4 062 91 :

230 Va.c.: 20VA rms for 0,3sec

. 4 062 92 :

230 Va.c.: 113VA rms for 0,25sec

230 Vd.c.: 50VA for 0.47sec

### Maximum power consumption in opening (peak):

. 4 062 90 :

24 Va.c.: 2A

48 Va.c.: 2,5A

24 Vd.c.: 1,5A

48 Vd.c.: 0,6A

. 4 062 91 :

230 Va.c.: 0,3A

. 4 062 92 :

230 Va.c.: 3,5A

230 Vd.c.: 0,48A

### Standby power consumption:

. 4 062 90 :

24 Va.c. = 1,2VA

48 Va.c. = 1,5VA

24 Vd.c. = 0,6W

48 Vd.c. = 0,75W

. 4 062 91 :

230 Va.c. = 1,5VA

. 4 062 92 :

230 Va.c. = 3,3VA

## 6. COMPLIANCE AND APPROVALS

### Compliance with standards:

- . CEE guidelines : 73/23/CEE + 93/68/CEE
- . Electromagnetic compatibility: EN 61543
- . Legrand devices can be used under the conditions of use as defined by IEC / EN 60947.

## 7. AUXILIARIES AND ACCESSORIES

### Signalling auxiliaries:





- . Auxiliary contact (½ module – cat n° 4 062 50 / 58).
- . Fault signalling changeover switch (½ module – cat n° 4 062 52 / 60).
- . Auxiliary contact modifiable in default signal (½ module – cat n° 4 062 56 / 62).
- . Auxiliary contact + fault signalling switch - can be modified into 2 auxiliary contacts (1 module - cat n° 4 062 64 / 66).

### Control auxiliaries:

- . Coupling with 4 062 90 / 91  
It is compulsory to fit a signalling auxiliary between the motor driven control unit and control auxiliaries (ET / MT / DA or POP).  
Shunt release (1 module - cat n°.4 062 76 / 78).  
Under voltage release (1 module - cat n° 4 062 80 / 82).  
Autonomous shunt trip for NC push-button (1 module - cat n°. 4 062 84).  
Power Overvoltage Protection "POP" (1 module - cat n°. 4 062 86).  
Autonomous shunt trip for NC push-button + associated battery (1.5 modules - cat n°. 4 062 87).
- . Coupling with 4 062 92  
It is imperative not to associate control auxiliaries (cat. n° 4 062 7x / 8x) to motor driven control module with automatic resetting.

### Possible combinations with auxiliaries:

- . Auxiliaries are clipped on the left of the Motor Driven Control Modules.
- . Maximum number of auxiliaries: 2.
- . Two signalling auxiliaries max. (cat. n° 4 062 50 / 52 / 56 / 58 / 60 / 62 / 64 / 66).
- . Only one control auxiliary (cat. n° 4 062 76 / 78 / 80 / 82 / 84 / 86 / 87).
- . If signalling and control auxiliaries are associated on the same circuit breaker, the control auxiliary (ref. 4 062 7x / 8x) must be placed to the left of the signalling auxiliary (ref. 4 062 50 / 52 / 56 / 58 / 60 / 62 / 64 / 66).
- . It is compulsory to fit a signalling auxiliary between the motor driven control unit and control auxiliaries (ET / MT / DA or POP).

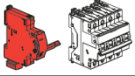
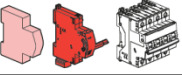
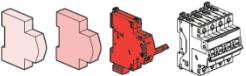
|   | CA / SD / ET / MT / DA / POP   |  | CM  |   |
|---|--|--|---|---|
|   |     |  |  |  |
|  |  |  | 4 062..<br>90 / 91 / 92 / 93 / 95   |   |
|  |  | 4 062..<br>50 / 52 / 56 / 58 / 60 /<br>62 / 64 / 66                                  | 4 062..<br>90 / 91 / 92 / 93 / 95   |   |
|  | 4 062..<br>50 / 52 / 56 / 58 / 60 / 62 / 76 /<br>78 / 80 / 82 / 84 / 86 / 87           | 4 062..<br>50 / 52 / 56 / 58 / 60 / 62   | 4 062 90 / 91   |   |
|   | 4 062..<br>50 / 52 / 56 / 58 / 60 / 62 / 64 /<br>66 / 76 / 78 / 80 / 82 / 84 / 86 / 87 | 4 062..<br>64 / 66   |   |   |
|   | 4 062..<br>50 / 52 / 56 / 58 / 60 / 62   | 4 062..<br>50 / 52 / 56 / 58 / 60 / 62   |   |   |
|   | 4 062..<br>50 / 52 / 56 / 58 / 60 / 62 / 64 / 66                                       | 4 062..<br>64 / 66   | 4 062 92  |   |
|   | 4 062..<br>50 / 52 / 56 / 58 / 60 / 62   | 4 062..<br>50 / 52 / 56 / 58 / 60 / 62   | 4 062 93 / 95   |   |
|   | 4 062..<br>50 / 52 / 56 / 58 / 60 / 62 / 64 / 66                                       | 4 062..<br>64 / 66   |   |   |