

70 RT HP is a new range of 16A to 160A switch disconnectors in isolating material and metal, supplied in a box. Available in control and emergency versions, the range is completed by board versions for front-panel or DIN rail assembly, in 16 to 63A options, all of which can be equipped with auxiliary contacts. These devices have been designed to deliver the ultimate in reliability, functionality and performance. They offer a technologically advanced solution that simplifies installation, reduces wiring times and ensures maximum safety and robustness, even in the most demanding conditions, thanks to the use of high-performance materials.

Versiune	Doză	Material	Metal
Tip	Pentru urgență	Curent nominal (A)	25
Înterupător	Rotary izolator	Clasă de protecție IP	IP66
Cod IK	IK10 (IK08 knob)	Temperatură ambiantă	-25 +60 °C
Lid screws (no. and type)	4 metal screws	Intrare orificii	2 x M20 + 2 x M25
Blocabil	YES (max. 3 locks in OFF)	Complet cu	Max. 2 auxiliary contacts
Current in AC22 (415V)	25	Current in AC23 (415V)	25
Secțiune cabluri	Max 10 mm ²	Dim. exterioare LxHxP (mm)	140x165x64
Electrocod	1742		

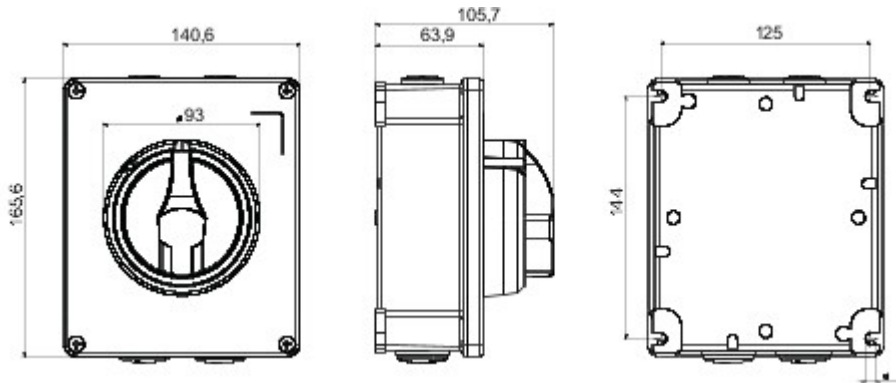

DIMENSIONAL



TECHNICAL SYMBOLOGY

IP

IP66

IK

IK10 (IK08 knob)

STANDARDS/APPROVALS

