

**Soliroc™**  
**Cat. 6A STP RJ 45 socket**

**Cat. No(s): 0 778 99**

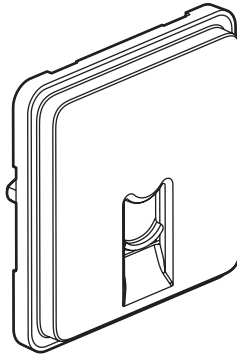

**1. USE**

Cat. 6A RJ 45 terminal socket for high speed connection to a network.  
 Enables data transmission at 10 Gbit/s.  
 Socket is used with F/UTP, S/FTP, F/FTP.

**The Soliroc™** IK10 range guarantees robust strength that will withstand the toughest conditions in hazardous or unsupervised areas, both indoors and outdoors (warehouses, public places, motorway service areas, offices, shops, educational institutions, places of detention, etc.).  
 Chrome-plated metal alloy faceplates that guarantee strength as well as high resistance to scratches, graffiti, tags and lighter flames. Plate supplied with a set of 4 plugs.

**The 5 commitments of the SOLIROC range**

**Safety:** the IK10 rating (20 joule impact energy) guarantees optimum impact resistance and protection against vandalism. It is impossible to remove a SOLIROC product as it is attached using 4 zamak blanking plugs that are force-mounted on the plate (can only be removed by drilling).

**Reliability:** the IP55 rating guarantees lasting use over time, both indoors and outdoors. All external parts are made of zamak for optimum strength.

**Practicality:** the plate is thin, making it difficult to grip and therefore limiting the risk of it being torn off. Minimum space between the parts, ensured by the IP5X rating (cannot be penetrated by solid matter greater than 1 mm and protected against dust).

**Installation:** depends on the type of support structure. We recommend using 50 mm deep multi-material or concrete BATIBOX boxes (40 mm depth is permitted).

To ensure optimum holding power:

- Attach the SOLIROC plates using 4 standard screws (diameter: 4 mm, length: 40 mm).

- Select the plug according to the type of support structure. For concrete we recommend a nylon expansion plug (diameter: 6 mm, usable length: 35 mm).

**Quality control:** factory-inspected in accordance with ISO 9001 procedures.

**2. RANGE**

Designation	Cat. No.
Cat. 6A STP RJ 45 - STP - 2 modules	0 778 99

**Presentation**

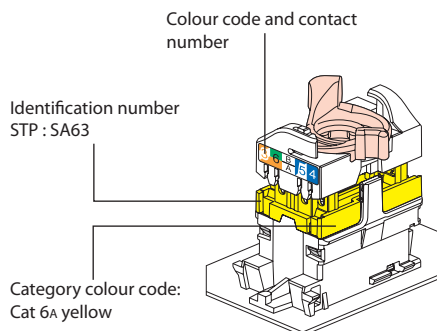

**3. DIMENSIONS (mm)**

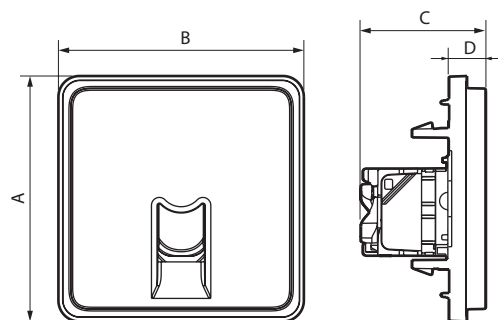

A	B	C	D
70.5	70.5	36	11

#### 4. CONNECTION

Accepts the following cable connectors:  
 RJ 11 (4 contacts), RJ 12 (6 contacts), RJ 45 (9 contacts).  
 Double colour code EIA - TIA 568 A and B on terminals:  
 STP 9 contacts 360° screen

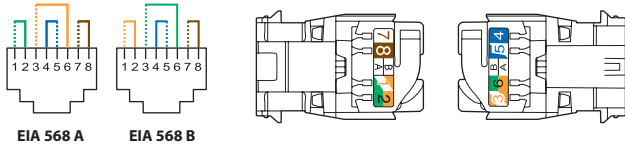

Conductors supported single wire/multiple wire: AWG 26 to 22  
 (0.4 to 0.65 mm)  
 Polyethylene conductor insulation: Ø admissible from 0.85 mm to 1.7 mm  
 RJ 45 connectors are equipped with a locking nut that does not require the use of a specific tool and which enables re-cabling in the event of error.

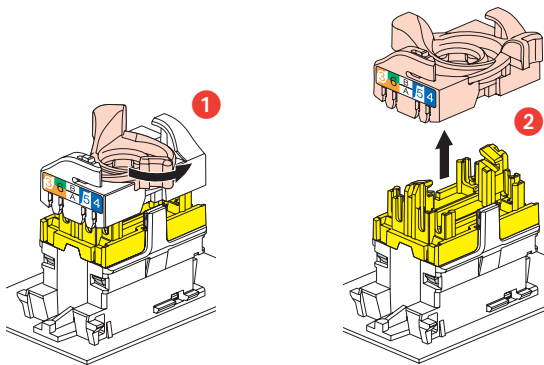

This system allows the wire pairs to be spread easily before mounting them on the connector.

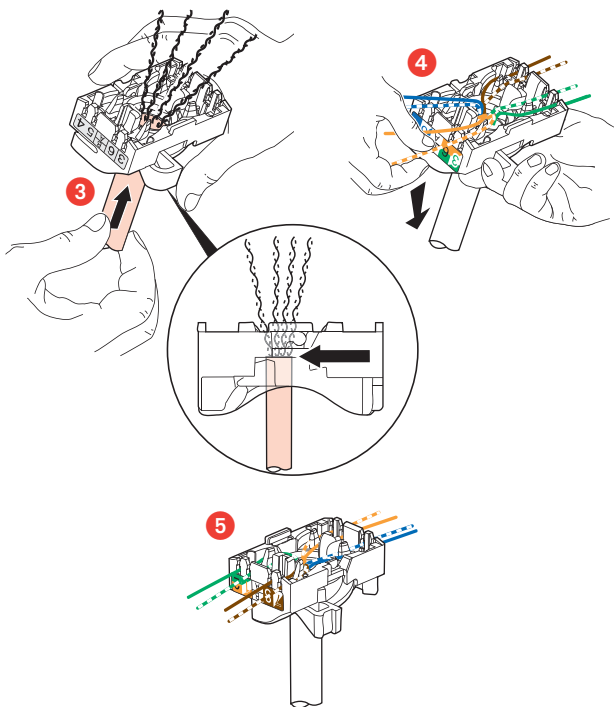

Spreading cables ensures that each pair is separated by the specified 13 mm.  
 Spreading pairs by 90° in relation to the cable ensures optimum performance.

#### 5. OPERATION

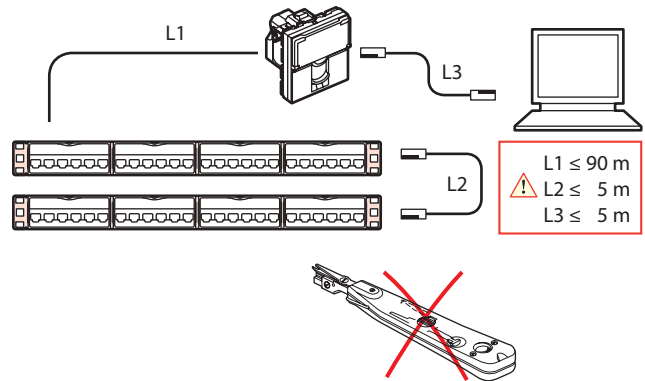

#### 6. TECHNICAL CHARACTERISTICS

##### 6.1 Mechanical characteristics

Protection index: IK 10 vandal-resistant  
 Penetration against solid/bodies and liquids: IP 55  
 Maximum impact resistance. All the products can withstand impacts of 20 joule.  
 Endurance: 2500 movements (plug insertion/withdrawal).

##### 6.2 Material characteristics

Plate: Zamak  
 Surface treatment: copper plating + acid treatment + dull nickel plating + chrome plating = approximately 0.1 mm thick.  
 Colour: grey with matte, chrome-plated appearance  
 Halogen-free  
 UV-resistant

Contacts: Gold/nickel, minimum thickness of gold > 0.8 µm  
 Metal parts: Bronze, nickel, platinum, gold  
 For STP products the body and the spreader are made of metal alloy with a copper-nickel coating.

Self-extinguishing:  
 850°C/30 s for insulating components holding live parts in place.  
 650°C for other insulating components.

##### 6.3 Electrical characteristics

Breakdown voltage ≥ 1000 V  
 Contact resistance ≤ 20 mΩ  
 Insulation resistance ≥ 500 mΩ at 100 Vdc  
 Compatible remote powering «PoE» up to 100 W (IEEE 802.3af, IEEE 802.3at, IEEE 802.3bt).

##### 6.4 Caractéristiques climatiques

Storage temperature: -10°C to +70° C  
 Usage temperature: -5°C to +40°C

#### 7. MAINTENANCE

Withstands cleaning products without damage.  
 Products such as hexane, methylated spirit, window-cleaning products, bleach diluted to 10%, graffiti remover, acetone, white spirit, white gas.

**Attention :** Pour l'utilisation de produits d'entretien spécifiques autres, un essai préalable est nécessaire.

#### 8. STANDARDS AND APPROVALS

Comply with installation and manufacturing standards.  
 See e-catalogue.

**9. PERFORMANCE**

■ **9.1 Performance of permanent link with F/UTP cable**  
 Return loss

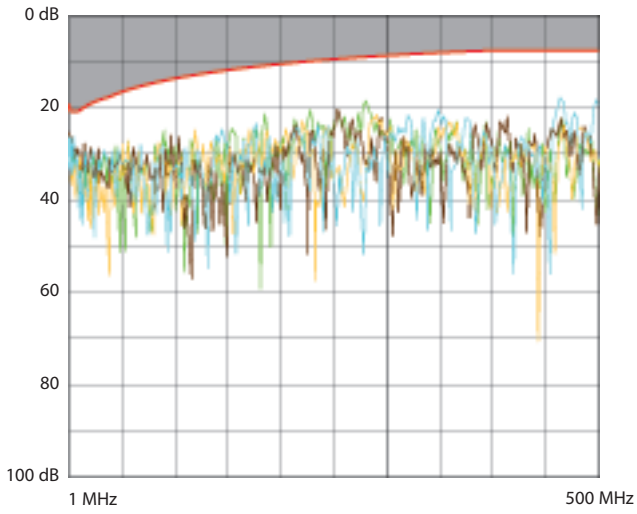

Attenuation

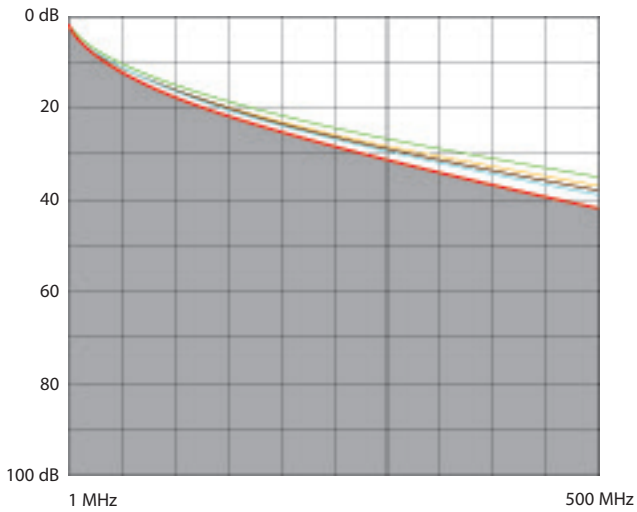

NEXT (Near end Crosstalk Attenuation)

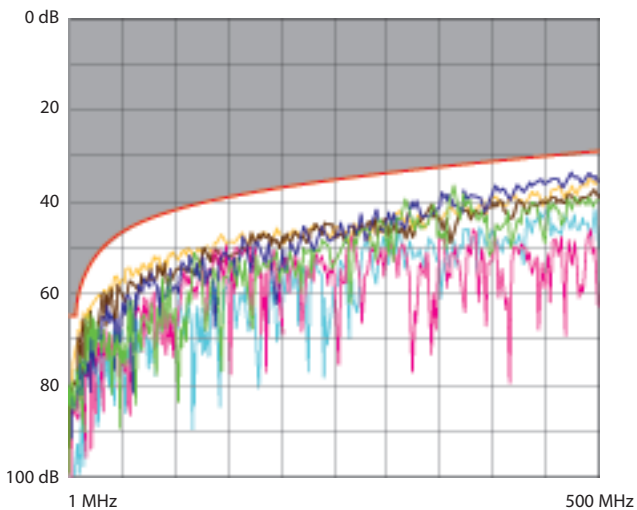

**9. PERFORMANCE (cont.)**

■ **9.1 Performance of permanent link with F/UTP cable (cont.)**  
 PS NEXT (Power Sum NEXT)

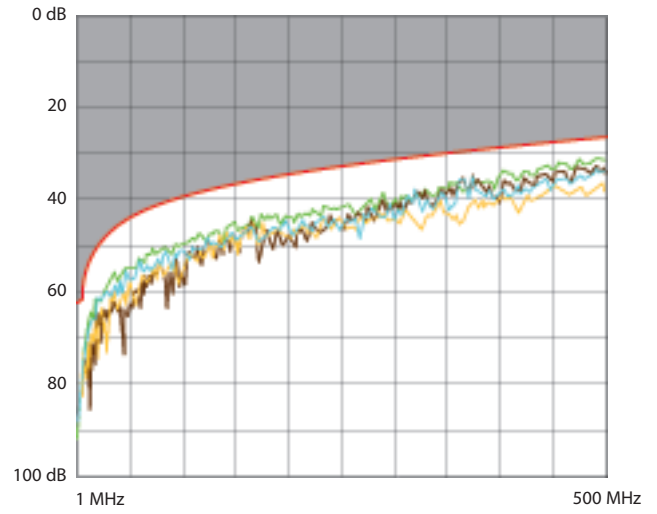

ACR (Attenuation to Crosstalk Ratio)

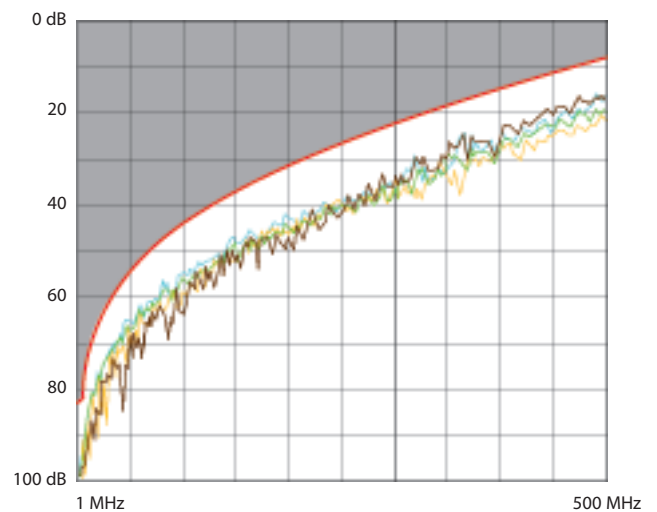

ELFEXT (Equal Level End Crosstalk Attenuation)

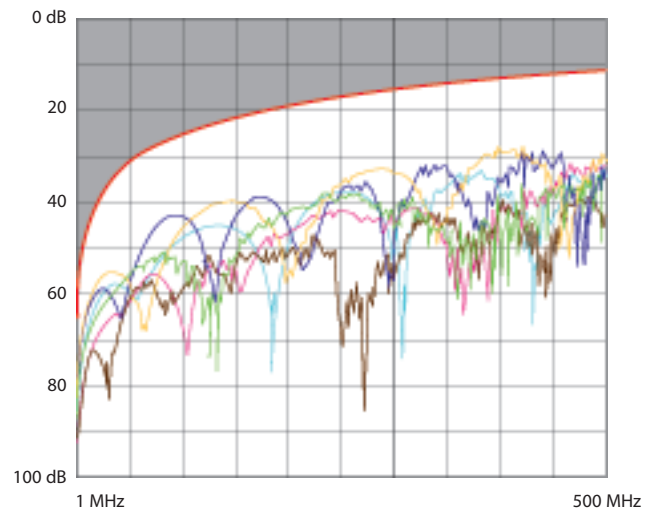

**9. PERFORMANCES (suite)**

■ **9.1 Performance of permanent link with F/UTP cable (cont.)**

Delay skew

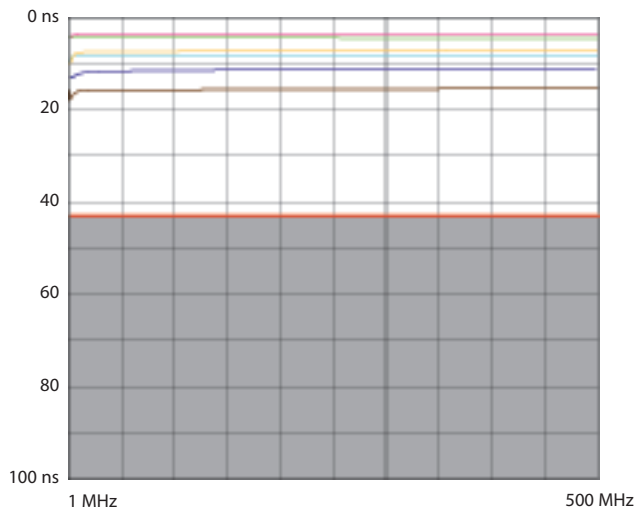

■ **9.2 Performance of permanent link with S/FTP cable**

Return loss

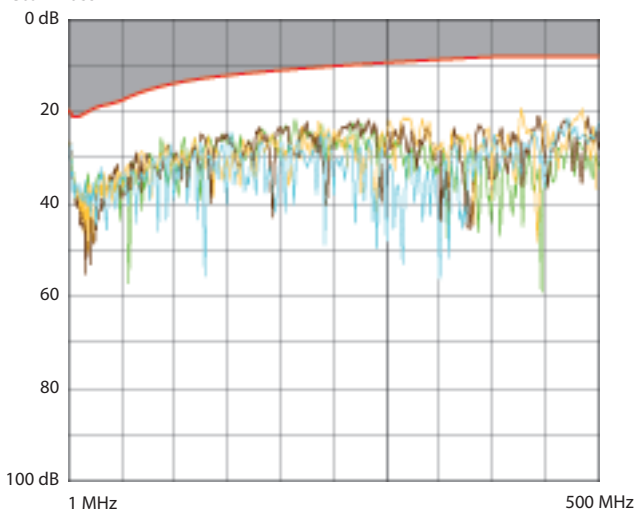

Attenuation

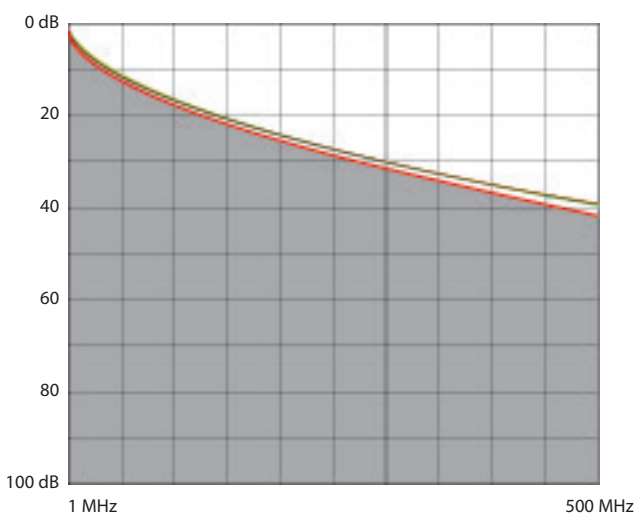

**9. PERFORMANCES (suite)**

■ **9.2 Performance of permanent link with S/FTP cable (cont.)**

NEXT (Near end Crosstalk Attenuation)

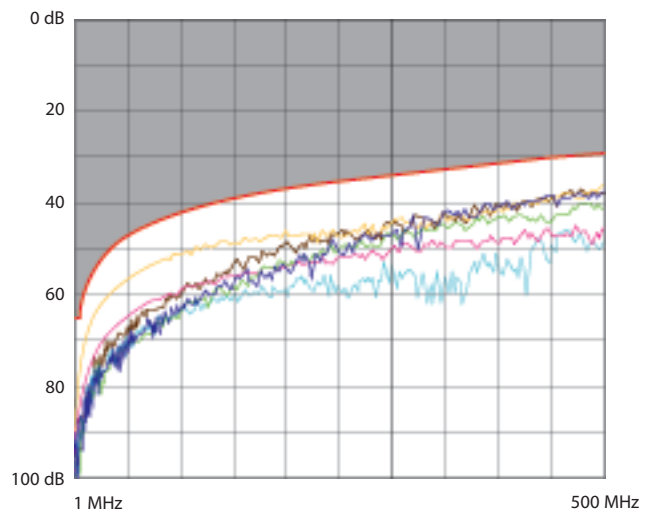

PS NEXT (Power Sum NEXT)

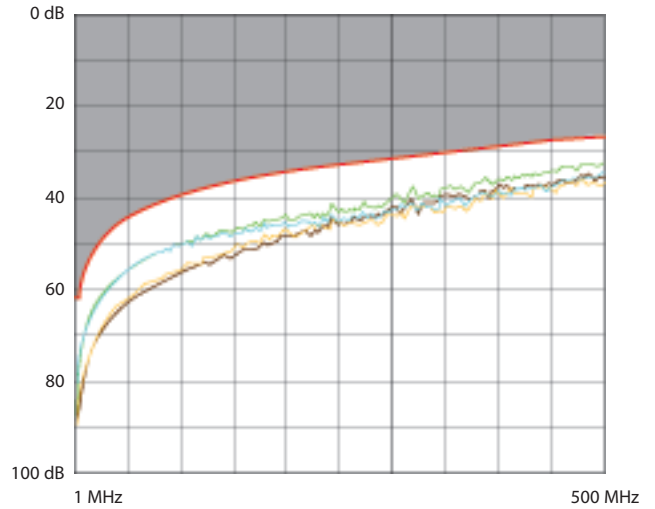

ACR (Attenuation to Crosstalk Ratio)

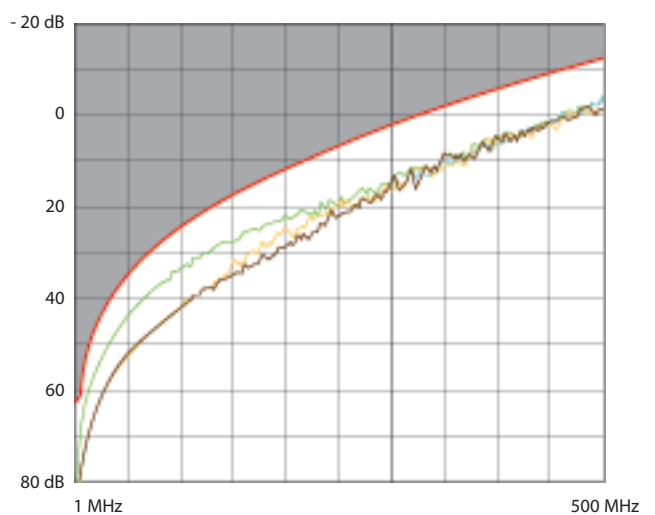

**9. PERFORMANCES (suite)**

■ **9.2 Performance of permanent link with S/FTP cable (cont.)**  
 ELFEXT (Equal Level End Crosstalk Attenuation)

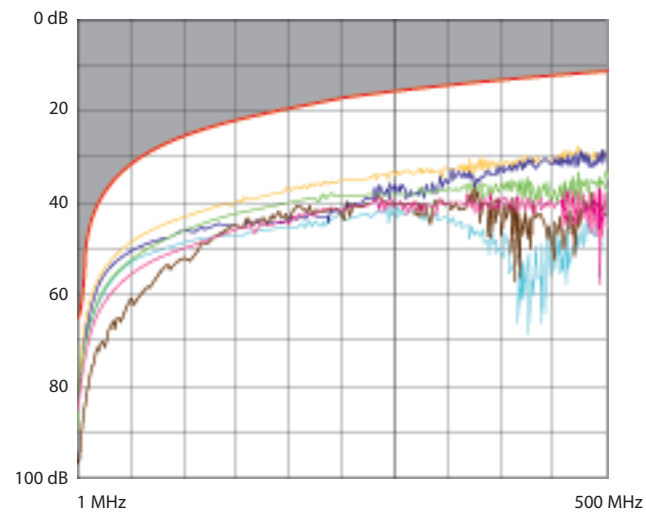

Delay skew

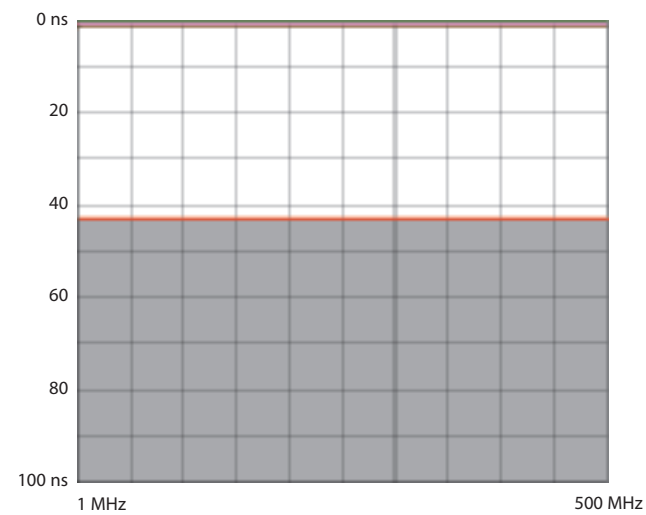

■ **9.3 Channel performance**

Return loss

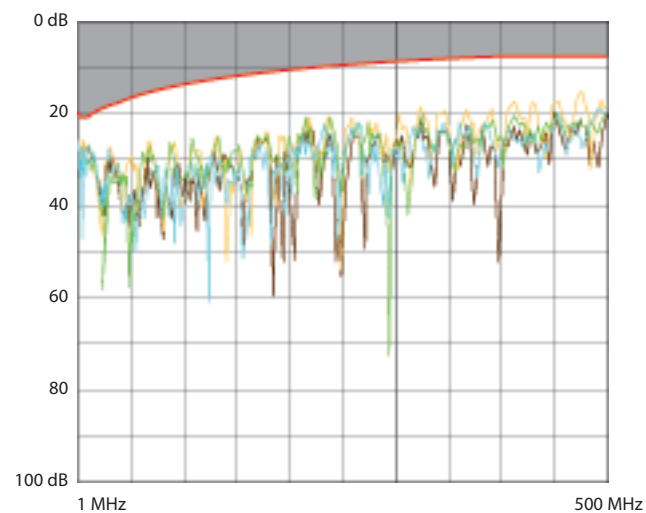

**9. PERFORMANCES (suite)**

■ **9.3 Channel performance (cont.)**  
 Attenuation

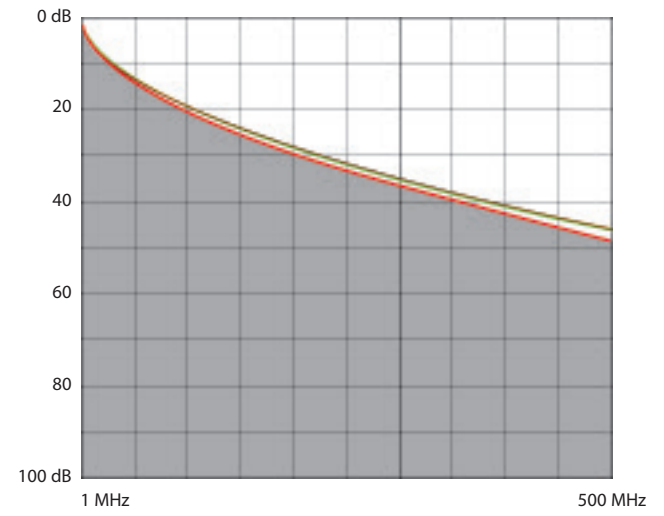

NEXT (Near end Crosstalk Attenuation)

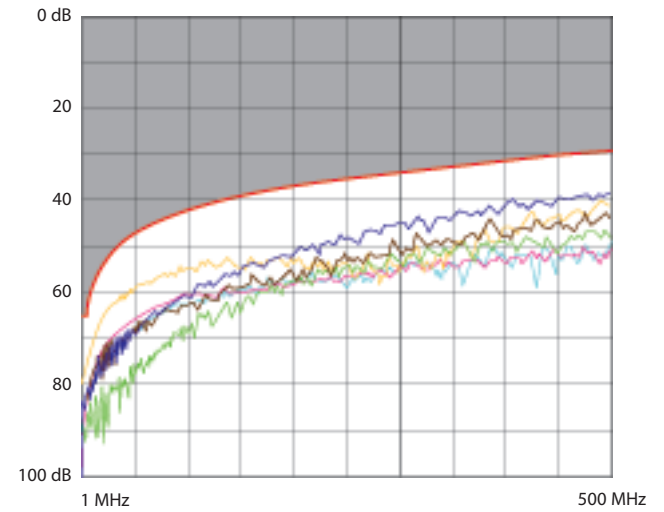

PS NEXT (Power sum NEXT)

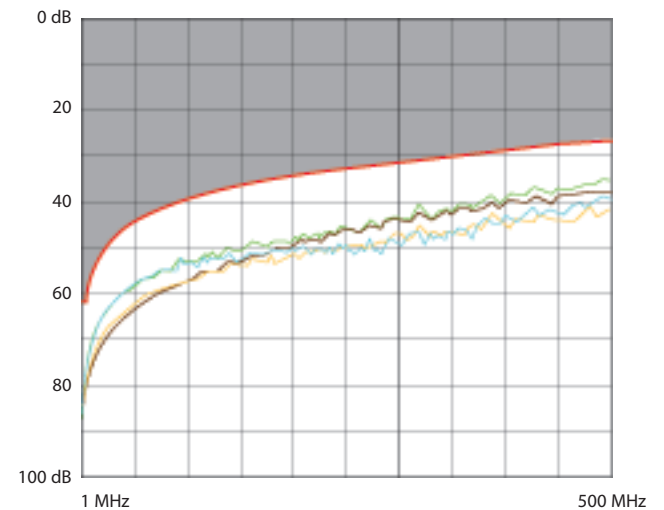

**9. PERFORMANCE (cont.)**

■ **9.3 Channel performance (cont.)**

ACR (Attenuation to Crosstalk Ratio)

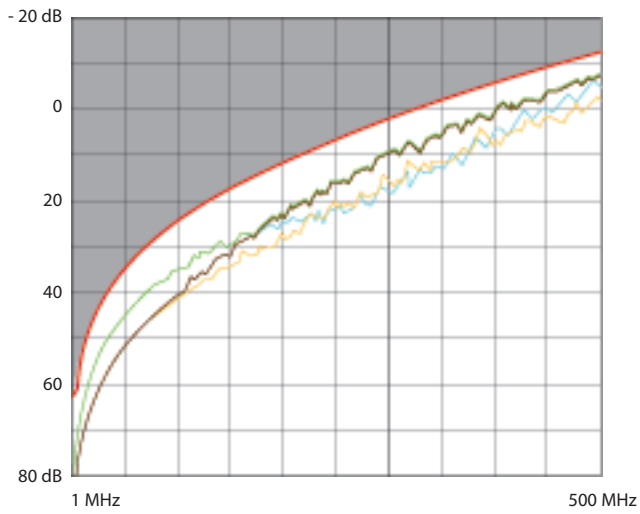

ELFEXT (Equal Level End Crosstalk Attenuation)

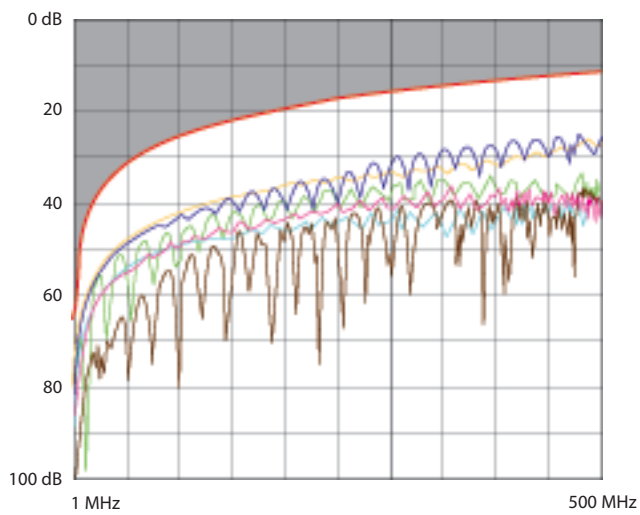

Delay skew

