

0 337 60/61/62



0 337 63/64/65

CONTENTS

Page

1. GENERAL CHARACTERISTICS	1
2. POSITIONING	1
3. TECHNICAL CHARACTERISTICS	2
4. INSTALLATION	2
5. DIMENSIONS	2
6. TYPICAL RJ45 CONNECTION.....	2
7. ACCESSORIES	3
8. PERFORMANCES	3

1. GENERAL CHARACTERISTICS

Equipped with new-generation Soluclips for automatic fixing (screwless) on cabinet and enclosure uprights (the soluclips are designed to adapt to uprights of thickness ranging from 1.5 to 2mm max).

Universal mounting in all racks or cabinets with automatic earthing on unpainted uprights. Painted uprights can be connected to earth with a cord and a screw connection.

Equipped with rear cable guide to hold cable during maintenance.

Equipped with 4 cassettes of 6 LCS3 RJ45 Cat. 6 connectors with toolless fast connection, marked 568 A/B.

Supplied with different colour identification labels for each cassette (blue, white, yellow, orange).

Conforming to standards ISO/IEC 11801 edition 3.0 (2017) and ANSI/TIA 568.2-D.

19" panel - 1 U.

Cassettes removed automatically by simply pressing the button on the front.

Each connector can be removed individually

Mounting a panel

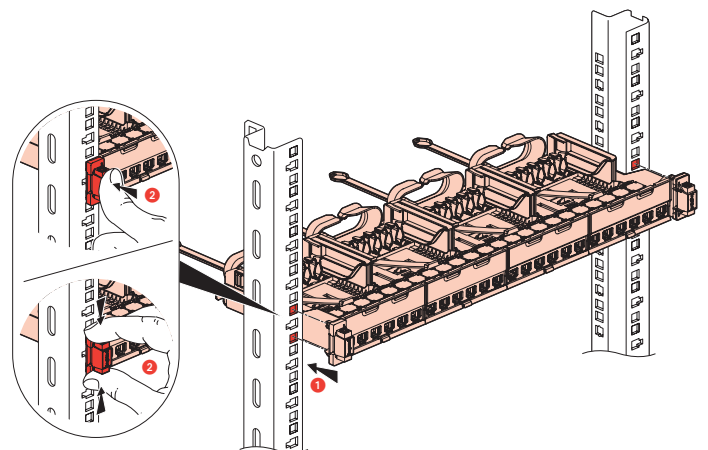

Mounting a cassette

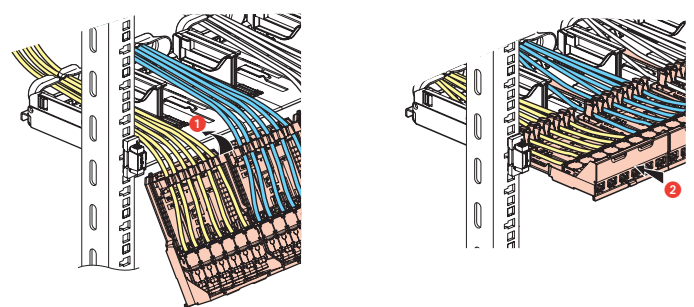

Removing a cassette

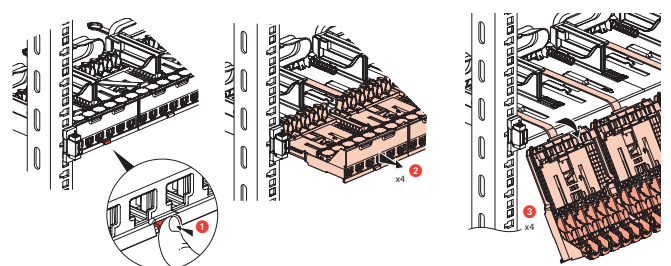

Description		UTP	FTP	STP	Weight (g)
	Panel with 24 RJ45 Cat. 6 UTP	0 337 60			1786
	Panel with 24 RJ45 Cat. 6 FTP		0 337 61		1786
	Panel with 24 RJ45 Cat. 6 STP			0 337 62	2505
	Connector with 6 RJ45 Cat. 6 UTP	0 337 63			11
	Connector with 6 RJ45 Cat. 6 FTP		0 337 64		11
	Connector with 6 RJ45 Cat. 6 STP			0 337 65	40

2. POSITIONING

Connectors are connected at the front without a special tool.

- Connectors clip onto the panel individually

No need for cable ties: the cable is held in its cable guide in the cassette and by a concentric strand guide on the panel.

3. TECHNICAL CHARACTERISTICS

3.1 Material characteristics

Panel: DC01 galvanised sheet steel

Connector:

- Contacts: gold/nickel, thickness of gold > 0.8 µm minimum
- Metal parts: bronze, nickel, platinum, gold
- Polycarbonate PBT

3.2 Electrical characteristics

Breakdown voltage: 1000 V

Contact resistance: 20 mΩ

Insulation resistance: 500 MΩ under 100 V DC

Compatible Remote Powering "PoE" up to 100W. (IEEE 802.3af, IEEE 802.3at, IEEE 802.3bt)

3.3 Mechanical characteristics

Max. number of connections and disconnections: 5 without replacing the wire

Endurance: 2500 operations (plug-in/pull-out)

IK03

3.4 Climatic characteristics

Operating temperature : -10°C to +60°C

Humidity : 5% to 85% (without condensation)

4. INSTALLATION

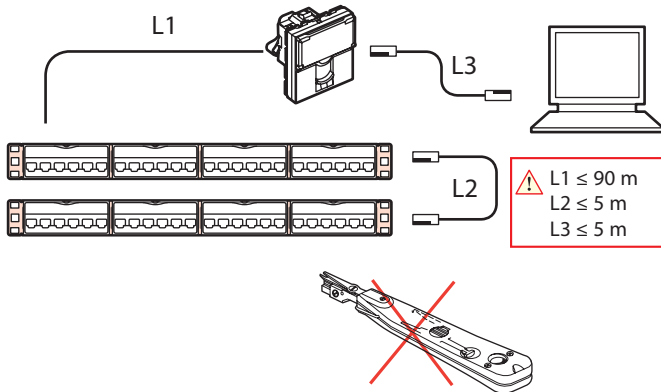

5. DIMENSIONS

Dimensions of panels 0 337 50/51

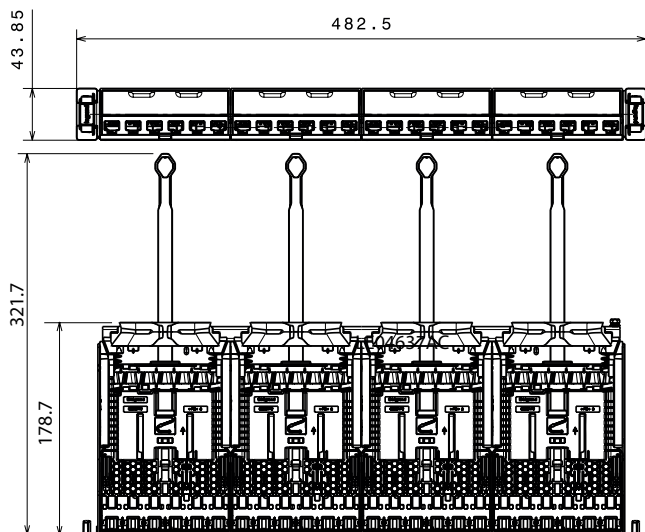

Dimensions of connectors 0 337 53/54

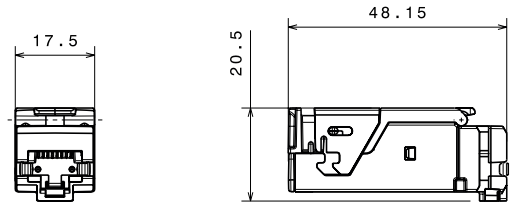

6. TYPICAL RJ45 CONNECTION

Takes the following plugs:

RJ 11 (4 contacts), RJ 12 (6 contacts), RJ 45 (9 contacts).

TIA 568 A and B dual colour code :

- UTP (8 contacts)
- FTP/STP (9 contacts)

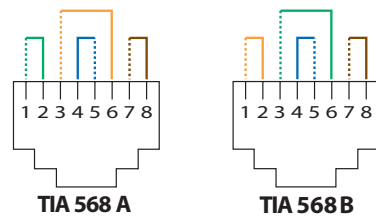

Colour code and contact number

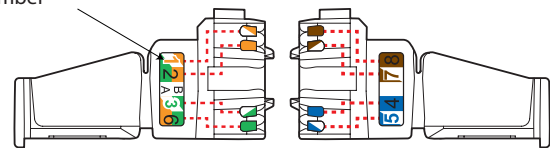

Identification number
 UTP : HD 51
 FTP : HD 52
 STP : HD 53

Catégorie colour code :
 Cat. 6 blue

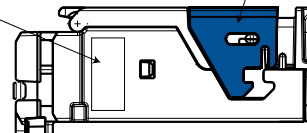

Permissible conductors:

- Single-core/Multicore: 0.4 to 0.65 mm, AWG 26 to 22
- Polyethylene conductor insulation: Ø 0.85 to 1.7 mm on insulation

Number of wires to be connected per connection: 1

RJ45 connectors are equipped with a locking nut. They do not require a special tool and can be re-wired if a mistake is made.

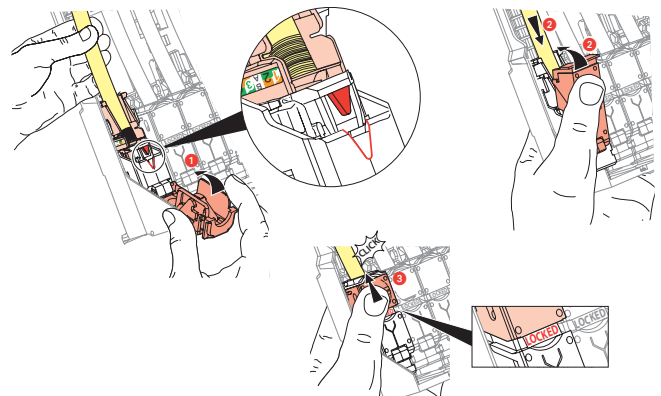

This system makes it easy to spread pairs before fitting them onto the connector.

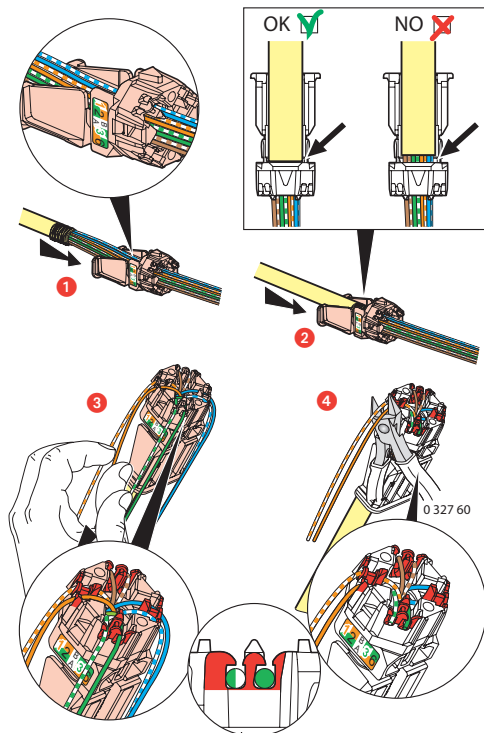

Spreading the cables and positioning the sleeve firmly in the spreader ensures that a pair-breakage distance of 13 mm is kept between pairs, as required by the standard.

Spreading pairs at 90° to the cable ensures the best possible performance.

7. ACCESSORIES

- **0 337 57:** Blanking cassette

Used to fill gaps in the panel.

- **0 337 57:** Port blanking plate

Blanking plate with 6 separable ports

Used to block up individually, partially or fully 1 to 6 ports (cassette with 6 ports) or 1 to 12 ports (HD cassette).

- **0 337 59:** Cable guide

2 cable guides to be clipped onto new-generation Soluclips.

Manages cables laterally by holding them and tilting them horizontally and vertically.

8. PERFORMANCES

8.1 Permanent link formances with U/UTP cable

The red line represents the limit line of standard, the black one, the extension of the limit line of standard.

Return loss

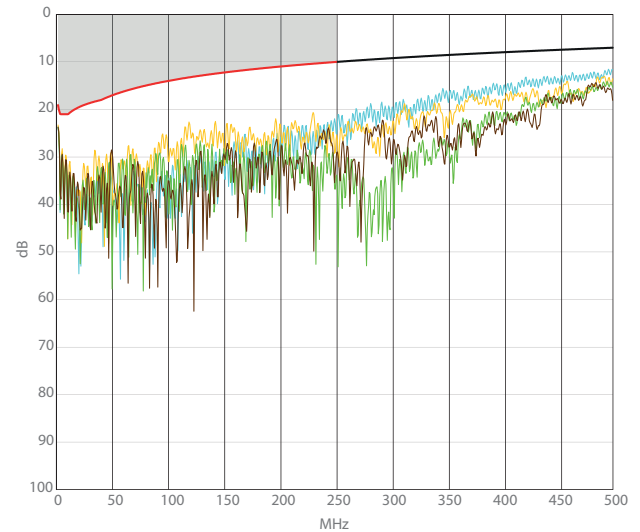

Attenuation

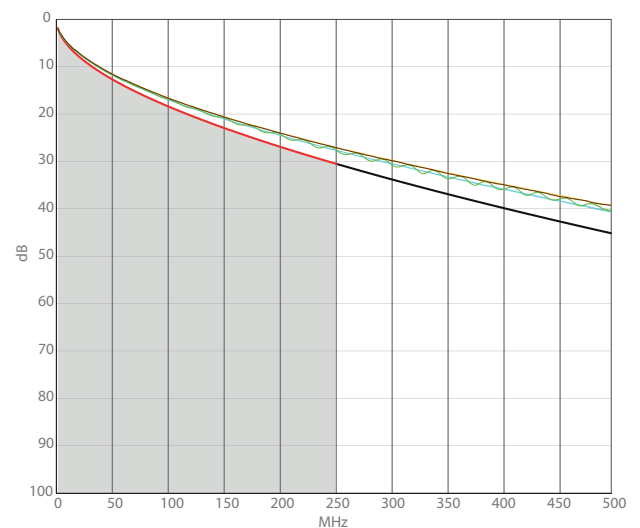

NEXT (Near end Crosstalk Attenuation)

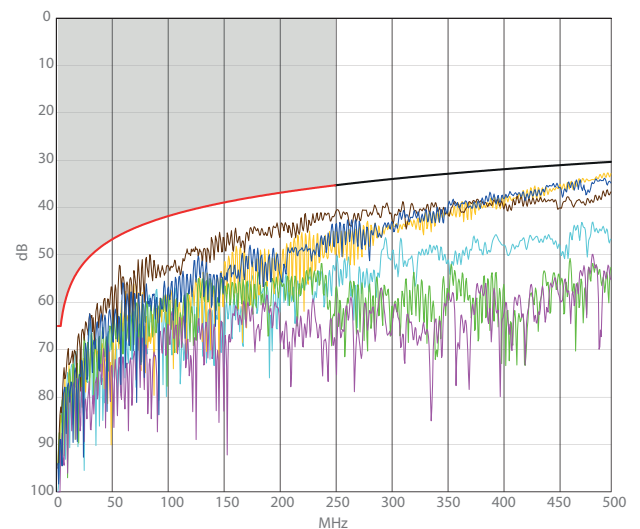

PS NEXT (Power Sum NEXT)

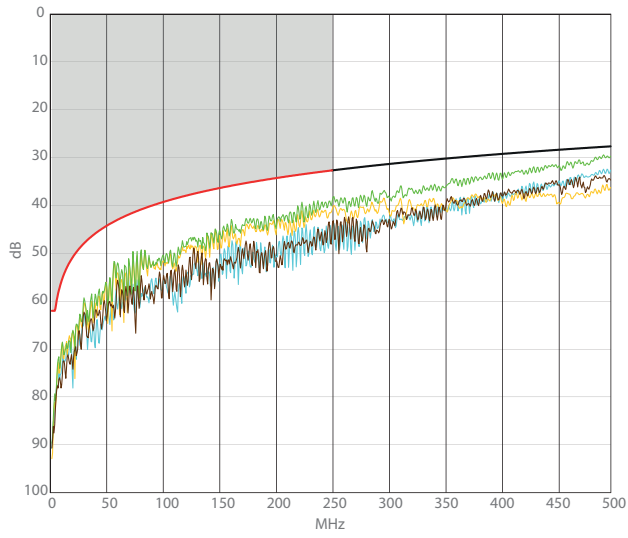

■ 8.2 Permanent link performances with F/UTP cable

Return loss

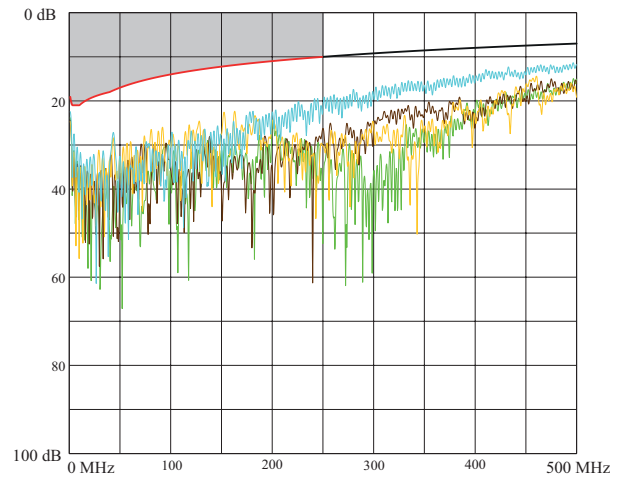

ACR (Attenuation to Crosstalk Ratio)

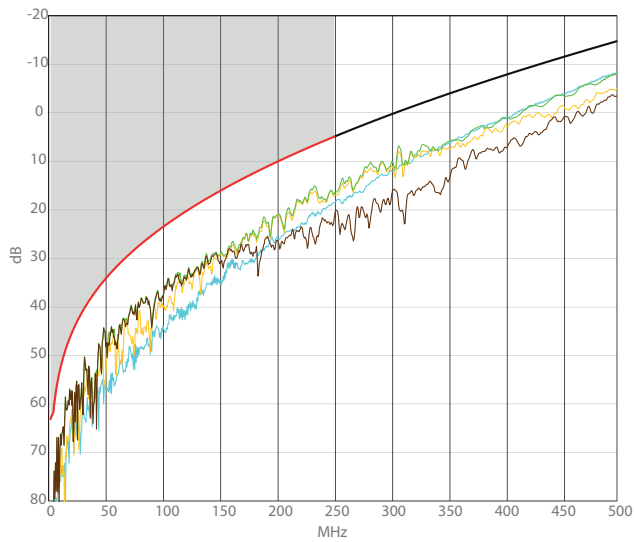

Attenuation

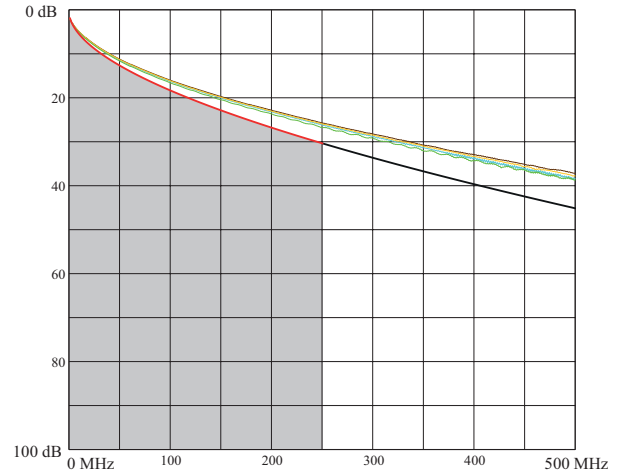

ELFEXT (Equal Level End Crosstalk Attenuation)

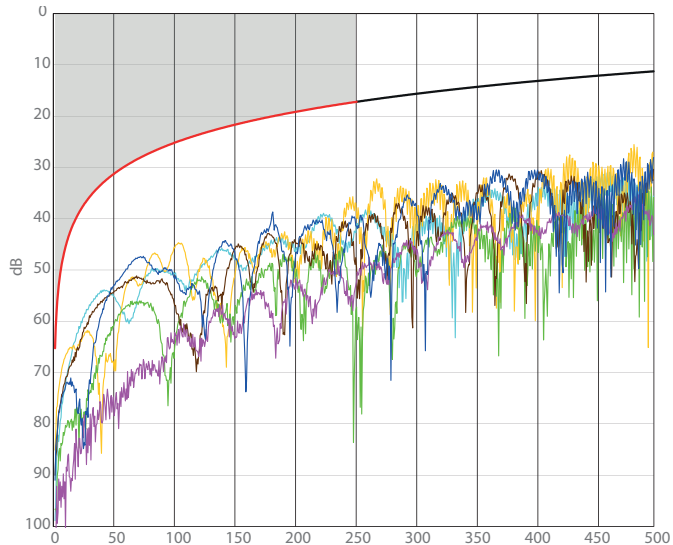

NEXT (Near end Crosstalk Attenuation)

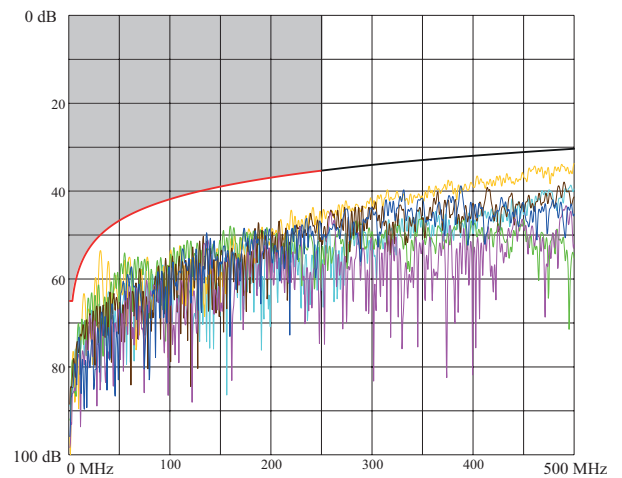

PS NEXT (Power Sum NEXT)

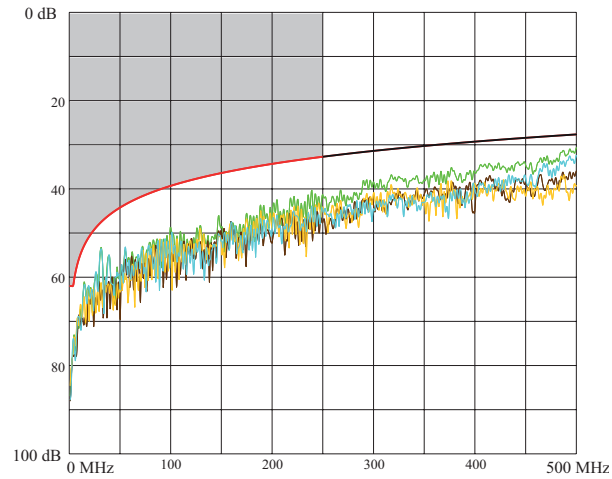

ACR (Attenuation to Crosstalk Ratio)

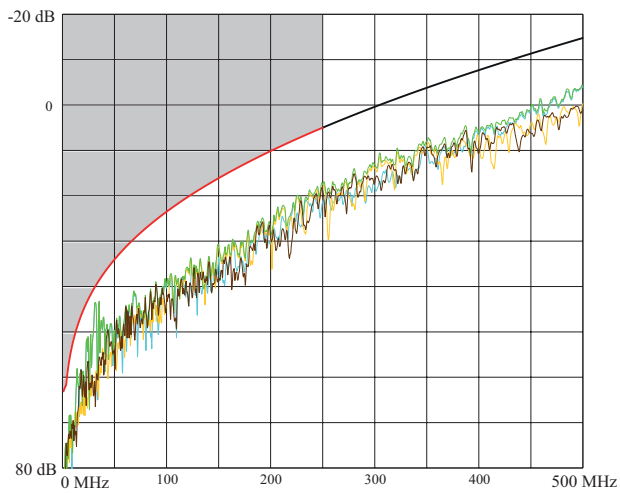

ELFEXT (Equal Level End Crosstalk Attenuation)

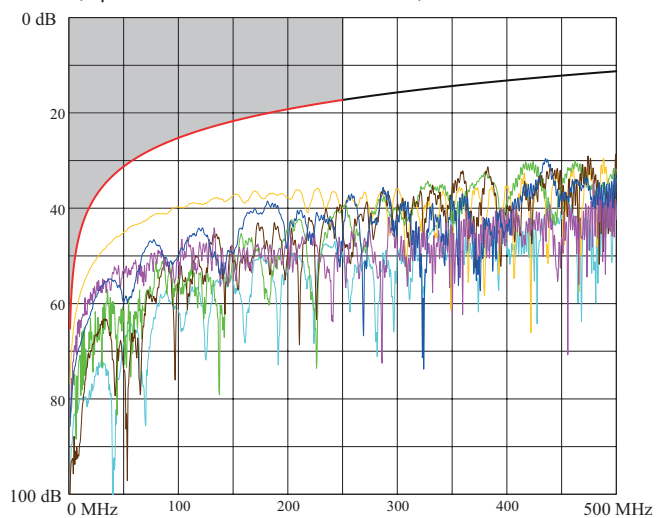

■ 8.3 Permanent link performances with SF/UTP cable

Return loss

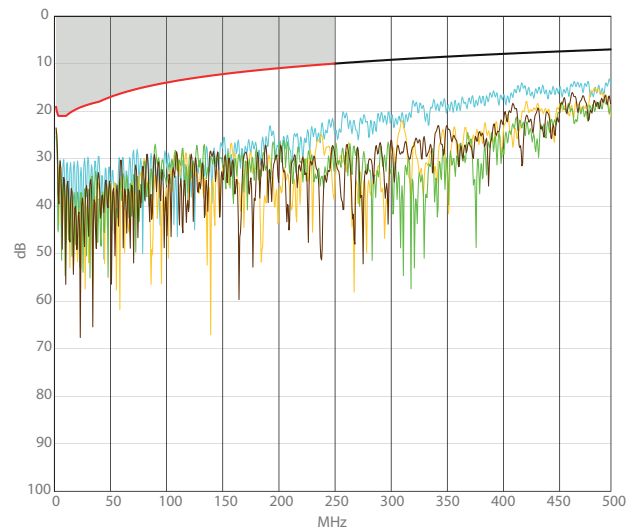

Attenuation

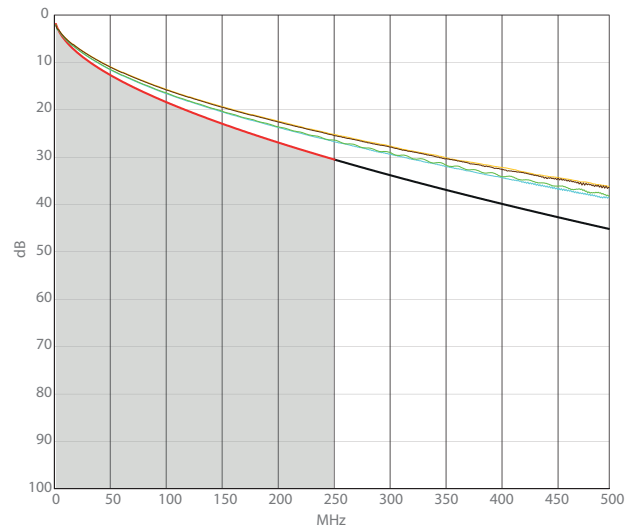

NEXT (Near end Crosstalk Attenuation)

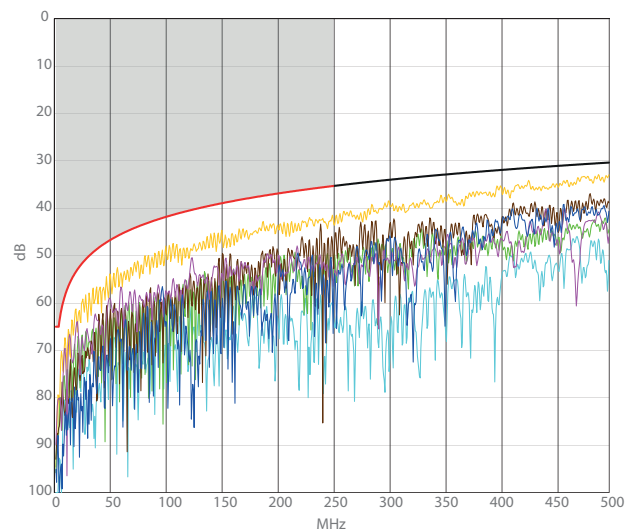

PS NEXT (Power Sum NEXT)

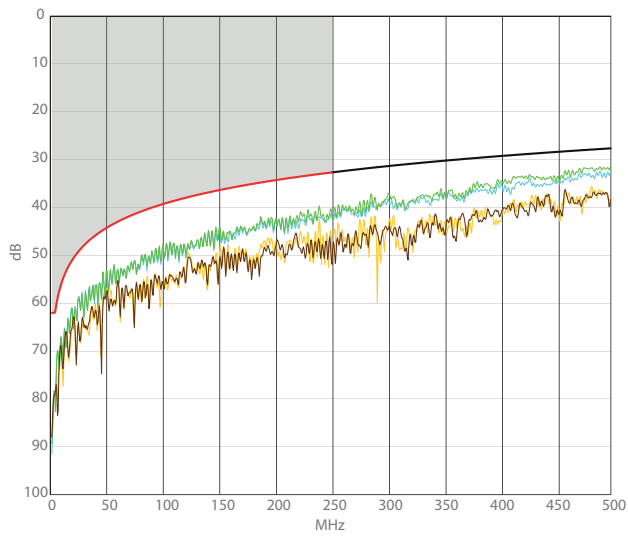

ACR (Attenuation to Crosstalk Ratio)

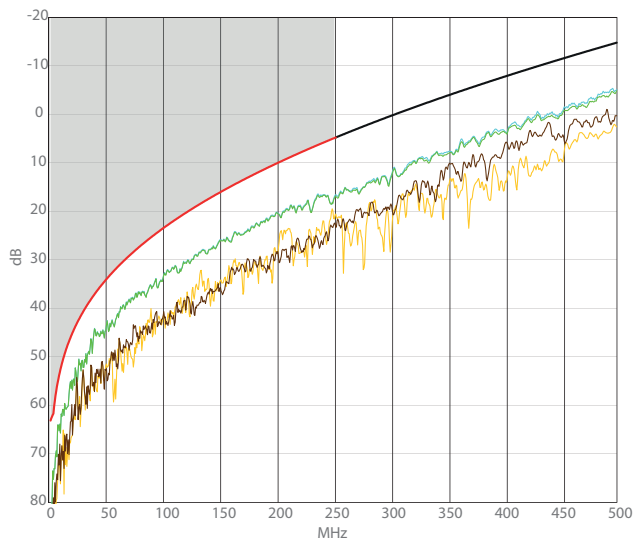

ELFEXT (Equal Level End Crosstalk Attenuation)

