

DX³ MCB 25kA 80A to 125A (1,5 modules per pole)

Cat N°(s): 4 097 49 to 51, 4 097 62 to 64, 4 097 75 to 77,
4 097 88 to 90, 4 098 01 to 03, 4 098 14 to 16, 4 098 40 to
42, 4 098 53 to 55



CONTENTS	PAGES
1. Description - Use	1
2. Range	1
3. Overall dimensions	1
4. Preparation - Connection	1
5. General characteristics	2
6. Conformities and approvals	7
7. Characteristic curves	7
8. Auxiliaries and accessories	16

1. DESCRIPTION - USE

Thermal-magnetic circuit breaker (MCB) with positive contact indication for control, protection against short-circuits and overloads, and isolation of electrical circuits.

Symbol:



Technology:

- . Current limiting device.
- . 1,5 module (26,7 mm) per pole.
- . Trip free mechanism.

2. RANGE

Number of Poles:

- . 1P / 2P / 3P / 4P.

Rated current In:

- . 80 / 100 / 125 B, C and D curves.

Tripping characteristics and magnetic tripping calibrations:

- . B curve (between 3 and 5 In).
- . C curve (between 5 and 10 In).
- . D curve (between 10 and 14 In).

Thermal threshold:

- . Non operating current (Inf): 1,05 In.
- . Operating current (If): 1,3 In.

Rated Voltage / Frequency:

- . 230 / 400 V ~, 50 / 60 Hz with standard tolerances.
- . 240 / 415 V ~, 50 / 60 Hz with standard tolerances.
- . 125 V per pole in direct current.

Maximum operating voltage:

- . 500 V ~, 50 / 60 Hz with derating of breaking capacity.

Breaking capacity:

- . 25 kA according to IEC/EN/NF 60947-2 standard

3. OVERALL DIMENSIONS

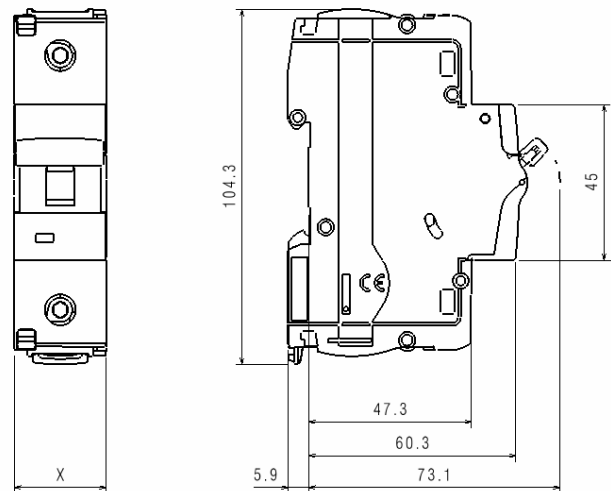

N° of poles	"X" (mm)
1P	26,7 mm
2P	53,4 mm
3P	80,1 mm
4P	106,8 mm

4. PREPARATION - CONNECTION

Fixing:

- . On symmetric rail EN/IEC 60715 or DIN 35.

Operating position:

- . Vertical Horizontal Upside down On the side

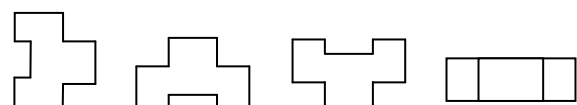

DX³ MCB 25kA 80A to 125A (1,5 modules per pole)

Cat N°(s): 4 097 49 to 51, 4 097 62 to 64, 4 097 75 to 77,
4 097 88 to 90, 4 098 01 to 03, 4 098 14 to 16, 4 098 40 to
42, 4 098 53 to 55

4. PREPARATION – CONNECTION *(continued)*

Supply:

- Either from the top or the bottom

Terminal depth:

- 19 mm.
- It is possible to separate the terminals by retractable insulation shields.

Stripping length recommended:

- 17 mm for main terminals.
- 10 mm for automatic terminals.

Screw head:

- Allen screw.

Tightening torque:

- Recommended: 5.5 Nm.
- Mini 4.5 Nm
- Maxi 6 Nm.

Tools required:

- For terminals: Allen wrench 4 mm.
- For fixing: flat screwdriver 5,5 mm (6 mm maximum).

Connectable section:

- For main terminals:

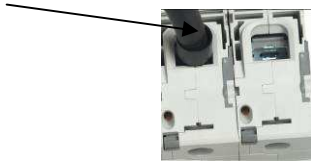

	Copper cable	
	Without ferrule	Without ferrule
Rigid cable	6 mm ² to 70 mm ²	-
Flexible cable	6 mm ² to 50 mm ²	6 mm ² to 50 mm ²

- For automatic terminals:

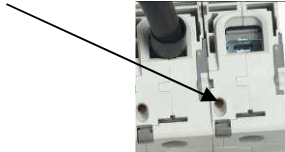

	Copper cable	
	Without ferrule	Without ferrule
Rigid cable	0.75 mm ² to 2.5 mm ²	-
Flexible cable	0.75 mm ² to 2.5 mm ²	0.75 mm ² to 1.5 mm ²

Manual actuation of the MCB:

- Ergonomic 2 position handle:
 - 0 / OFF: Device open.
 - 1 / ON: Device closed.

4. PREPARATION – CONNECTION *(continued)*

Contact status display:

- By marking of the associated m.c.b. handle:
 - “O-Off” white on a green background = contacts opened.
 - “I-On” white on a red background = contacts closed.
- By mechanical indicator on front face:
 - Green = contacts opened.
 - Red = contacts closed.

Sealing:

- Possible in “Open” position (OFF) or “Close” position (ON).

Lockout::

- By 5 mm padlock (cat. n° 4 06313) or 6 mm padlock (cat. n° 0 227 97) with padlock support (cat. n° 4 063 03) in “Open” position

Consignment:

- On site padlocking system, possible only open circuit - 0 / OFF handle position - with 1,5mm² stripped wire for example or 2,4mm wide Colring.

Labelling:

- Circuit identification by way of a label inserted in the label holder situated on the product.

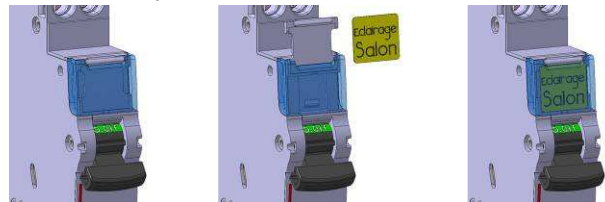

5. GENERAL CHARACTERISTICS

Front side marking:

- By permanent ink pad printing showing:
 - Trade name: DX³
 - Breaking curve
 - Rated current (in A)
 - Icu in kA, Breaking capacity according to IEC/ EN 60947-2 standard (25kA)
 - Catalogue number and logo
 - Mark: Legrand



DX³ MCB 25kA 80A to 125A (1,5 modules per pole)

Cat N°(s): 4 097 49 to 51, 4 097 62 to 64, 4 097 75 to 77,
4 097 88 to 90, 4 098 01 to 03, 4 098 14 to 16, 4 098 40 to
42, 4 098 53 to 55

5. GENERAL CHARACTERISTICS (continued)

Short-circuit breaking capacity:

. Alternate current 50/60Hz, single-phase or three-phase network,
according to IEC 60947-2. B, C and D curves

Un		1P	2P	3P / 4P
110 V~	I _{cu}	36 kA	72 kA	-
230 V~		25 kA	50 kA	50 kA
400 V~		--	25 kA	25 kA
440 V~		-	20kA	20kA
500 V~		-	10kA	10kA

Un	I _{cs}	75% of I _{cu}	75% of I _{cu}	75% of I _{cu}
110 V~	I _{cs}	75% of I _{cu}	75% of I _{cu}	75% of I _{cu}
230 V~				
400 V~				

Short-circuit breaking capacity of only one pole:

- . Three-phase network 220 / 380 V~ to 240 / 415 V~
 - for TN neutral system, I_{cn1} = 25 kA (under 220 to 240 V~)
 - for IT neutral system, I_{it} = 6,25 kA (under 380 to 415 V~)
- . In three-phase network 110 / 220 V~ to 120 / 240 V~
 - for TN neutral system, I_{cn1} = 50 kA (under 110 to 127 V~)
 - for IT neutral system, I_{it} = 12,5 kA (under 220 to 240 V~)

Short-circuit breaking capacity in DC current:

. Direct current according to standard IEC 60947-2

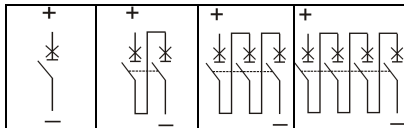

Un		1P	2P	3P	4P
24 ÷ 48 V d.c.	I _{cu}	25 kA	25 kA	-	-
110 V d.c.		-	25 kA	25 kA	-
230 V d.c.		-	-	-	25 kA

24 ÷ 48 V d.c.	I _{cs}	25 kA	25 kA	-	-
110 V d.c.		-	25 kA	25 kA	-
230 V d.c.		-	-	-	25 kA

Minimum operating voltage :

. 12 V a.c. / d.c. per pole.

Pulse rated voltage:

. U_{imp} = 6 kV (wave 1.5 / 50 μs).

Insulation rated voltage:

. U_i = 500 V.

5. GENERAL CHARACTERISTICS (continued)

Pollution degree::

. 3.

Dielectric strength:

. 2500 V.

Operation at 400Hz:

. The magnetic thresholds increase by 45%.

Load to close and open of a pole through the handle:

- . 0,17 Nm per pole to close.
- . 0,09 Nm per pole to open.

Mechanical endurance according to IEC 60947-2 :

- . 20 000 operations without load
- . 10 000 operations with load (under I_n x Cos φ=0.9)
- . 2 000 operations with load (under I_n in DC current)

Enclosure material:

- . Polyester.
- . Characteristics of this material: self extinguishing, heat and fire resistant according to EN 60898-1, glow-wire test at 960°C for external parts made of insulating material necessary to retain in position current-carrying parts and parts of protective circuit (650°C for all other external parts made of insulating material).

Average weight per pole:

. 0,220 kg.

Volume when packed:

	Volume (dm ³)
Single pole	0,36
Double pole	0,63
Triple / Four pole	1,14

Ambient operating temperature:

. Min. = -25°C. Max. = +70°C

Ambient storage temperature:

. Min. = -40°C. Max. = +70°C

Protection class:

- . Protection index of terminals against solid and liquid bodies: IP 20 (according to IEC 529, EN 60529 et NF C 20-010).
- . Protection index of the box against solid and liquid bodies: IP 40 (according to IEC 529, EN 60529 et NF C 20-010).
- . Protection index against mechanical shocks: IK 02 (according to EN 50102 et NF C 20-015).

Resistance to sinusoidal vibrations:

- . According to IEC 60068-2-35.
- . Axis : x, y, z.
- . Frequency range: 5÷100 Hz ; duration 90 minutes
- . Displacement (5÷13,2 Hz) : 1mm.
- . Acceleration (13,2÷100 Hz) : 0,7g (g=9,81 m/s²)

DX³ MCB 25kA 80A to 125A (1,5 modules per pole)

Cat N°(s): 4 097 49 to 51, 4 097 62 to 64, 4 097 75 to 77,
4 097 88 to 90, 4 098 01 to 03, 4 098 14 to 16, 4 098 40 to
42, 4 098 53 to 55

5. GENERAL CHARACTERISTICS *(continued)*

Recognition:

. Recognition of the circuit by insertion of a label in the label holder.

Power dissipated per pole at In (in W) :

. mcbs B, C and D curves

In	80 A	100 A	125 A
1P to 4P	8,8	10	15.6

. Impedance per pole (Ω) = $\frac{\text{Power dissipated}}{I_n^2}$

Derating of circuit-breakers according to ambient temperature :

. The nominal characteristics of a circuit breaker are modified according to the ambient temperature inside the cabinet or the enclosure where the circuit breaker is located.

. Reference temperature: 40°C according IEC/EN 60947-2.

In (A)	Ambient temperature / In									
	-25°C	-10°C	0°C	10°C	20°C	30°C	40°C	50°C	60°C	70°C
80	102	97	94	91	88	84	80	76	72	69
100	128	122	118	114	110	105	100	95	90	86
125	160	152	147	142	137	131	125	119	113	108

Derating of MCB for use with fluorescent lights:

Ferromagnetic and electronic ballasts have a high inrush current for a short time. These currents can cause the tripping of circuit breakers. At the time of the installation, it should take into account the maximum number of ballasts per circuit breaker that the manufacturers of lamps and ballasts indicate in their catalogues.

Influence of the altitude:

	≤2000 m	3000 m	4000 m	5000 m
Dielectric holding	3000 V	2500 V	2000 V	1500 V
Max operational Voltage	400 V	400 V	400 V	400 V
Derating at 40°C	none	none	none	none

Derating of MCBs function of the number of devices side by side:

When several MCBs are juxtaposed and operate simultaneously, the thermal evacuation of the poles is limited. This results in an increase in operating temperature of the circuit breakers which can cause unwanted tripping. It is recommended to apply the following coefficients to the rated currents.

Number of circuit breakers side by side	Coefficient
2 - 3	0.9
4 - 5	0.8
6 - 9	0.7
≥ 10	0.6

These values are given by the recommendation of IEC 60439-1, NF C 63421 and EN 60439-1 standards.

To avoid to have to use these coefficients, it is necessary to allow a good ventilation and to separate the devices with 0.5 module spacing elements (cat. N° 4 063 07).

DX³ MCB 25kA 80A to 125A (1,5 modules per pole)

Cat N°(s): 4 097 49 to 51, 4 097 62 to 64, 4 097 75 to 77,
4 097 88 to 90, 4 098 01 to 03, 4 098 14 to 16, 4 098 40 to
42, 4 098 53 to 55

5. GENERAL CHARACTERISTICS *(continued)*

Back-up protection between modular circuit-breakers and fuses in three-phase network (+ neutral) 400 / 415 V~ according to IEC/EN 60947-2:

For TT or TN neutral system in 230/400 V network, to know the breaking capacity of the combination of a double pole breaker (connected between phase and neutral under 230V) downstream of a triple-pole circuit-breaker, take the values shown in Tables 230/400V.

m.c.b. downstream		Fuse upstream			
		gG type		aM type	
		125A	160A	125A	160A
DX ³ 25kA B, C and D curves	80A to 125A	100kA	100kA	100kA	100kA

All these values are also valid for circuit breakers associated to differential blocks.

According to the curves and ratings of circuit breakers, attention to the magnetic threshold and to the size of upstream circuit breakers which must necessarily be higher.

MCB's back-up protection in three-phase network (+ neutral) 400 / 415 V~ according to IEC/EN60947-2:

For TT or TN neutral system in 230/400 V network, to know the breaking capacity of the combination of a double pole breaker (connected between phase and neutral under 230V) downstream of a triple-pole circuit-breaker, take the values shown in Tables 230/400V.

m.c.b. downstream		m.c.c.b. upstream												
		DPX 125		DPX ³ 160 / DPX ³ 160 + diff.			DPX 160		DPX 250ER			DPX 250ER AB		
		36kA		50kA			36 - 50kA		36 - 50kA			36kA		
		100A	125A	100A	125A	160A	100A	125A	100A	160A	250A	130A	170A	240A
DX ³ 25kA B and C curves	80A	30kA	30kA	36kA	36kA	25kA	30kA	30kA	30kA	30kA	30kA	30kA	30kA	30kA
	100A	-	30kA	-	36kA	36kA	-	30kA	-	30kA	30kA	-	30kA	30kA
	125A	-	-	-	-	36kA	-	30kA	-	30kA	30kA	-	30kA	30kA
DX ³ 25kA D curve	80A	30kA	30kA	36kA	36kA	25kA	30kA	30kA	30kA	30kA	30kA	30kA	30kA	30kA
	100A	-	30kA	-	36kA	36kA	-	30kA	-	30kA	30kA	-	30kA	30kA
	125A	-	-	-	-	36kA	-	30kA	-	30kA	30kA	-	30kA	30kA

m.c.b. downstream		m.c.c.b. upstream													
		DPX ³ 250 / DPX ³ 250+diff.				DPX - H / L 250			DPX 400AB		DPX / DPXH / DPXL 630MT				
		36 - 70kA				36 - 70 - 100kA			36kA		36 - 70 - 100kA				
		100A	160A	200A	250A	100A	160A	250A	320A	400A	250A	320A	400A	500A	630A
DX ³ 25kA B and C curves	80A	36kA	36kA	36kA	36kA	36kA	36kA	36kA	36kA	36kA	36kA	36kA	36kA	36kA	36kA
	100A	-	36kA	36kA	36kA	-	36kA	36kA	30kA	30kA	30kA	30kA	30kA	30kA	30kA
	125A	-	36kA	36kA	36kA	-	36kA	36kA	30kA	30kA	30kA	30kA	30kA	30kA	30kA
DX ³ 25kA D curve	80A	36kA	36kA	36kA	36kA	36kA	36kA	36kA	36kA	36kA	36kA	36kA	36kA	36kA	36kA
	100A	-	36kA	36kA	36kA	-	36kA	36kA	30kA	30kA	30kA	30kA	30kA	30kA	30kA
	125A	-	36kA	36kA	36kA	-	36kA	36kA	30kA	30kA	30kA	30kA	30kA	30kA	30kA

All these values are also valid for circuit breakers associated to differential blocks.

According to the curves and ratings of circuit breakers, attention to the magnetic threshold and to the size of upstream circuit breakers which must necessarily be higher.

DX³ MCB 25kA 80A to 125A (1,5 modules per pole)

Cat N°(s): 4 097 49 to 51, 4 097 62 to 64, 4 097 75 to 77,
4 097 88 to 90, 4 098 01 to 03, 4 098 14 to 16, 4 098 40 to
42, 4 098 53 to 55

5. GENERAL CHARACTERISTICS *(continued)*:

Back-up protection between modular circuit-breakers and fuses in three-phase network (+ neutral) 230 / 240 V~ according to IEC/EN 60947-2:

m.c.b. downstream		Fuse upstream			
		gG type		aM type	
		125A	160A	125A	160A
DX ³ 25kA B, C and D curves	80A to 125A	100kA	100kA	100kA	100kA

All these values are also valid for circuit breakers associated to differential blocks.

According to the curves and ratings of circuit breakers, attention to the magnetic threshold and to the size of upstream circuit breakers which must necessarily be higher.

MCB's back-up protection in three phase network (+ neutral) 230 / 240 V~ according to IEC/EN 60947-2:

m.c.b. downstream		m.c.c.b. upstream												
		DPX ³ 160 DPX ³ 160 + diff.			DPX 160		DPX 160		DPX 250ER			DPX 250ER		
		50kA			36kA		50kA		36kA			50kA		
		100A	125A	160A	100A	160A	100A	160A	100A	160A	250A	100A	160A	250A
DX ³ 25kA B and C curves	80A	65kA	65kA	65kA	-	-	55kA	55kA	-	-	-	55kA	55kA	55kA
	100A	-	65kA	65kA	-	-	-	55kA	-	-	-	-	55kA	55kA
	125A	-	-	65kA	-	-	-	55kA	-	-	-	-	55kA	55kA
DX ³ 25kA D curve	80A	65kA	65kA	65kA	-	-	55kA	55kA	-	-	-	55kA	55kA	55kA
	100A	-	65kA	65kA	-	-	-	55kA	-	-	-	-	55kA	55kA
	125A	-	-	65kA	-	-	-	55kA	-	-	-	-	55kA	55kA

m.c.b. downstream		m.c.c.b. upstream														
		DPX ³ 250 DPX ³ 250 + diff.				DPX 250			DPX H / L 250			DPX 630MT				
		70kA				36kA			70 – 100kA			36kA				
		100A	160A	200A	250A	100A	160A	250A	100A	160A	250A	250A	320A	400A	500A	630A
DX ³ 25kA B and C curves	80A	60kA	60kA	60kA	60kA	55kA	55kA	55kA	60kA	60kA	60kA	55kA	55kA	55kA	55kA	55kA
	100A	-	60kA	60kA	60kA	-	55kA	55kA	-	60kA	60kA	55kA	55kA	55kA	55kA	55kA
	125A	-	60kA	60kA	60kA	-	55kA	55kA	-	60kA	60kA	55kA	55kA	55kA	55kA	55kA
DX ³ 25kA D curve	80A	60kA	60kA	60kA	60kA	55kA	55kA	55kA	60kA	60kA	60kA	55kA	55kA	55kA	55kA	55kA
	100A	-	60kA	60kA	60kA	-	55kA	55kA	-	60kA	60kA	55kA	55kA	55kA	55kA	55kA
	125A	-	60kA	60kA	60kA	-	55kA	55kA	-	60kA	60kA	55kA	55kA	55kA	55kA	55kA

All these values are also valid for circuit breakers associated to differential blocks.

According to the curves and ratings of circuit breakers, attention to the magnetic threshold and to the size of upstream circuit breakers which must necessarily be higher.

DX³ MCB 25kA 80A to 125A (1,5 modules per pole)

Cat N°(s): 4 097 49 to 51, 4 097 62 to 64, 4 097 75 to 77,
4 097 88 to 90, 4 098 01 to 03, 4 098 14 to 16, 4 098 40 to
42, 4 098 53 to 55

5. GENERAL CHARACTERISTICS *(continued)*

Selectivity between two levels of protection

- . The downstream circuit breaker must always have a magnetic threshold and a rated current lower than those of the upstream protection.
- . Selectivity is indicated total (T) if there is selectivity up to the value of breaking capacity (according to IEC / EN 60947-2) of the downstream circuit breaker.

Selectivity between MCB and MCB or MCCB upstream:

- . Selectivity limit at 400V~: values in Ampere.

		m.c.c.b. upstream						
		DX ³ 25kA Curve D		DPX ³ 160E / B / N DPX ³ 160E / B / N + diff.		DPX 160	DPX 250ER	
		16 – 25kA		16 - 25 - 50kA		25 – 36 – 50kA	25 – 36 – 50kA	
m.c.b. downstream		100A	125A	125A	160A	160A	160A	250A
DX ³ 25kA B and C curves	80A	1200	1500	5000	6000	5000	5000	5000
	100A	-	1500	-	5000	4000	4000	4000
	125A	-	-	-	3000	2000	2000	3000
DX ³ 25kA D curve	80A	1200	1500	5000	6000	4000	4000	5000
	100A	-	1500	-	5000	3000	3000	4000
	125A	-	-	-	3000	1500	1500	2000

		m.c.c.b. upstream								
		DPX 250 / H / L		DPX 250ER AB	DPX ³ 250 DPX ³ 250 + diff			DPX 400AB		
		25 - 70 - 100kA		36kA	25 - 36 - 70kA			36kA		
m.c.b. downstream		160A	250A	240A	100A	160A	200A	250A	320A	400A
DX ³ 25kA B and C curves	80A	8000	T	T	4000	T	T	T	T	T
	100A	6000	T	T	-	T	T	T	T	T
	125A	3000	8000	T	-	T	T	T	T	T
DX ³ 25kA D curve	80A	8000	T	T	-	T	T	T	T	T
	100A	6000	T	T	-	T	T	T	T	T
	125A	3000	7000	T	-	-	T	T	T	T

Selectivity between modular circuit breakers and fuses:

- . Selectivity limit at 400V~: values in Ampere.

		Fuse. upstream					
		aM type			gG type		
		100A	125A	160A	100A	125A	160A
m.c.b. downstream		100A	125A	160A	100A	125A	160A
DX ³ 25kA B and C curves	80A	3000	6000	8000	3000	3000	4000
	100A	-	4000	5000	-	3000	3500
	125°	-	-	4000	-	-	3500
DX ³ 25kA D curve	80A	-	4000	5000	-	2000	3000
	100A	-	-	4000	-	-	2000
	125A	-	-	-	-	-	-

DX³ MCB 25kA 80A to 125A (1,5 modules per pole)

Cat N°(s): 4 097 49 to 51, 4 097 62 to 64, 4 097 75 to 77,
4 097 88 to 90, 4 098 01 to 03, 4 098 14 to 16, 4 098 40 to
42, 4 098 53 to 55

6. CONFORMITIES AND APPROVALS

Compliance to standards:

- . Standard: IEC/EN 60947-2.
- . CEE guidelines : 73/23/CEE + 93/68/CEE
- . Legrand circuit-breakers can be used under the conditions of use as defined by IEC / EN 60947.
- . The performance of circuit breakers can be influenced by particular climates: hot dry, cold dry, hot humid, salt fog atmosphere

Classification according to Annex Q (standard IEC/EN 60947-1) :

- . Category C with a range test temperature -25 °C / +70 °C
- . salt fog atmosphere according IEC 60068-2-52

Respect of the environment – Compliance with CEE directives:

- . Compliance with Directive 2002/95/EC of 27/01/03 called "RoHS" which provides for the banning of hazardous substances such as lead, mercury, cadmium, hexavalent chromium, brominated flame retardants polybrominated biphenyls (PBBs) and polybrominated diphenyl ethers (PBDEs) from 1st July 2006
- . Compliance with Directive 91/338/CEE of 18/06/91 and Decree 94-647 of 27/07/04

Plastic materials :

- . Halogens-free plastic materials.
- . Marking of parts according to ISO 11469 and ISO 1043.

Packaging:

- . Design and manufacture of packaging in accordance with Decree 98-638 of 07.20.98 and Directive 94/62/EC

DX³ MCB 25kA 80A to 125A (1,5 modules per pole)

Cat N°(s): 4 097 49 to 51, 4 097 62 to 64, 4 097 75 to 77,
4 097 88 to 90, 4 098 01 to 03, 4 098 14 to 16, 4 098 40 to
42, 4 098 53 to 55

7. CURVES

Current limiting curve:
B, C and D curves

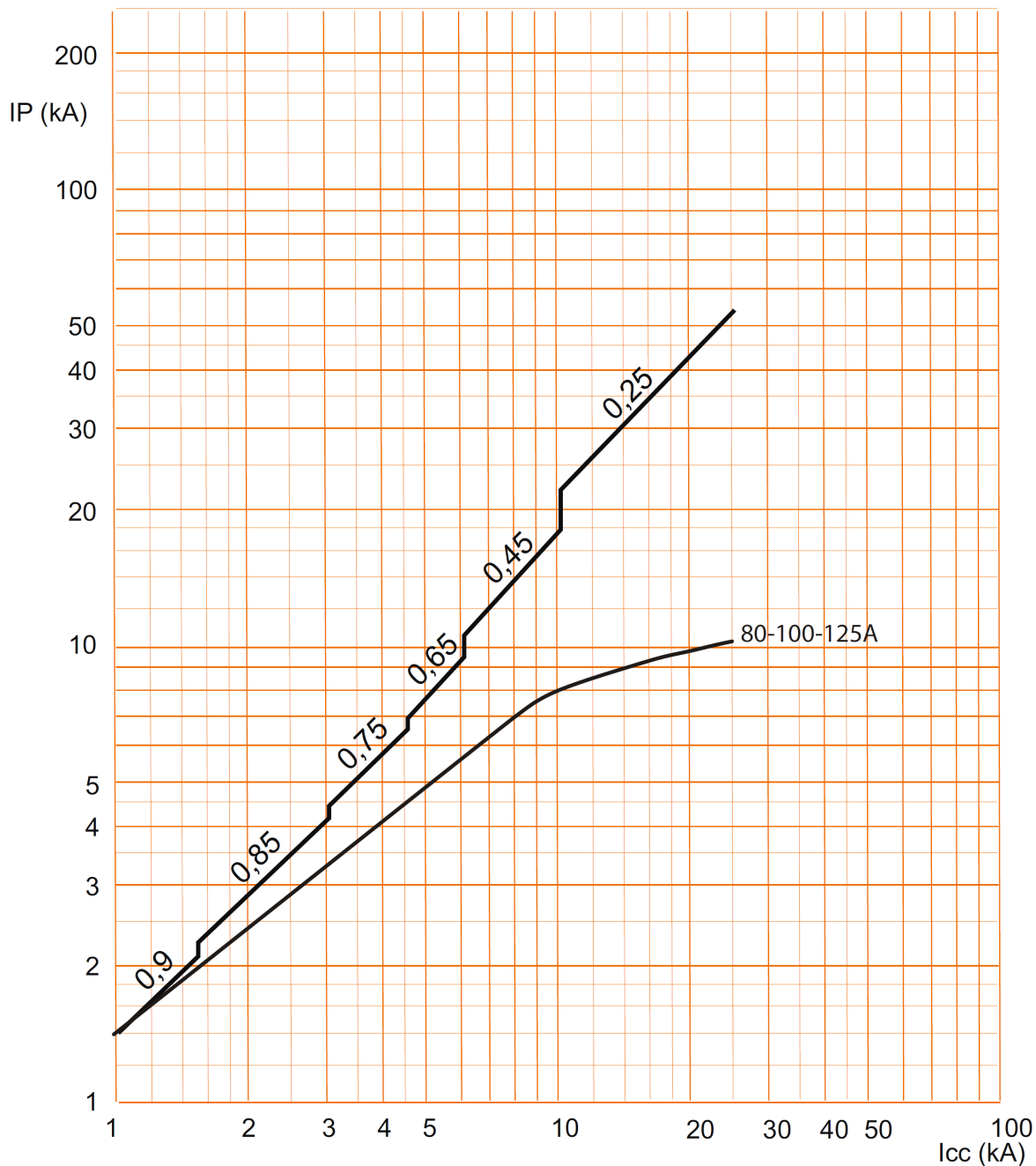

. I_{cc} = Square value of symmetric component of the short circuit current (kA).
. IP = Max peak value (kA)

DX³ MCB 25kA 80A to 125A (1,5 modules per pole)

Cat N°(s): 4 097 49 to 51, 4 097 62 to 64, 4 097 75 to 77,
4 097 88 to 90, 4 098 01 to 03, 4 098 14 to 16, 4 098 40 to
42, 4 098 53 to 55

7. CURVES (continued)

Operating characteristic of circuit breakers B curve:

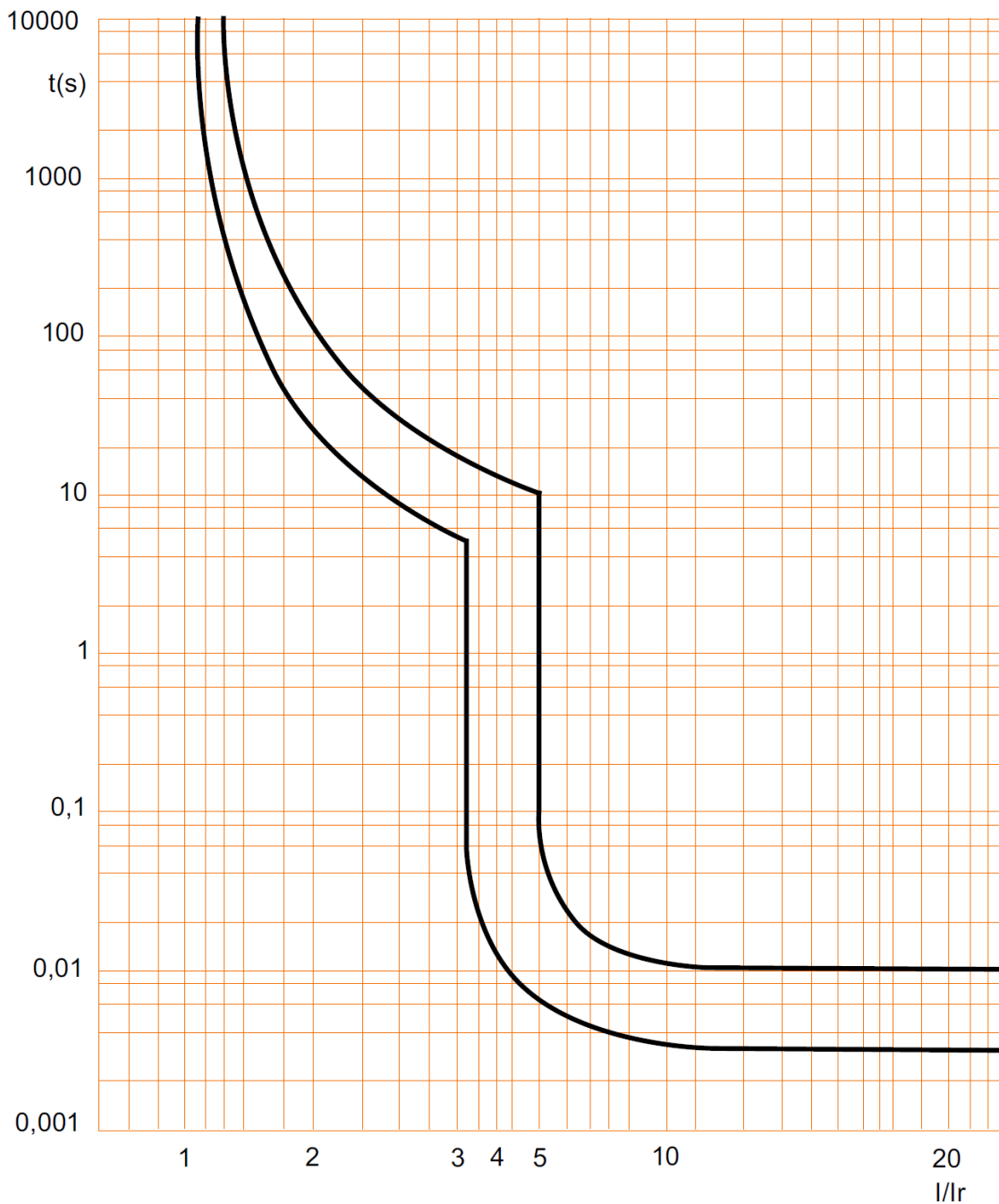

DX³ MCB 25kA 80A to 125A (1,5 modules per pole)

Cat N°(s): 4 097 49 to 51, 4 097 62 to 64, 4 097 75 to 77,
4 097 88 to 90, 4 098 01 to 03, 4 098 14 to 16, 4 098 40 to
42, 4 098 53 to 55

7. CURVES (continued)

. Thermal energy limiting curves of circuit breakers B curve, 4P (400V~ / 50Hz) :

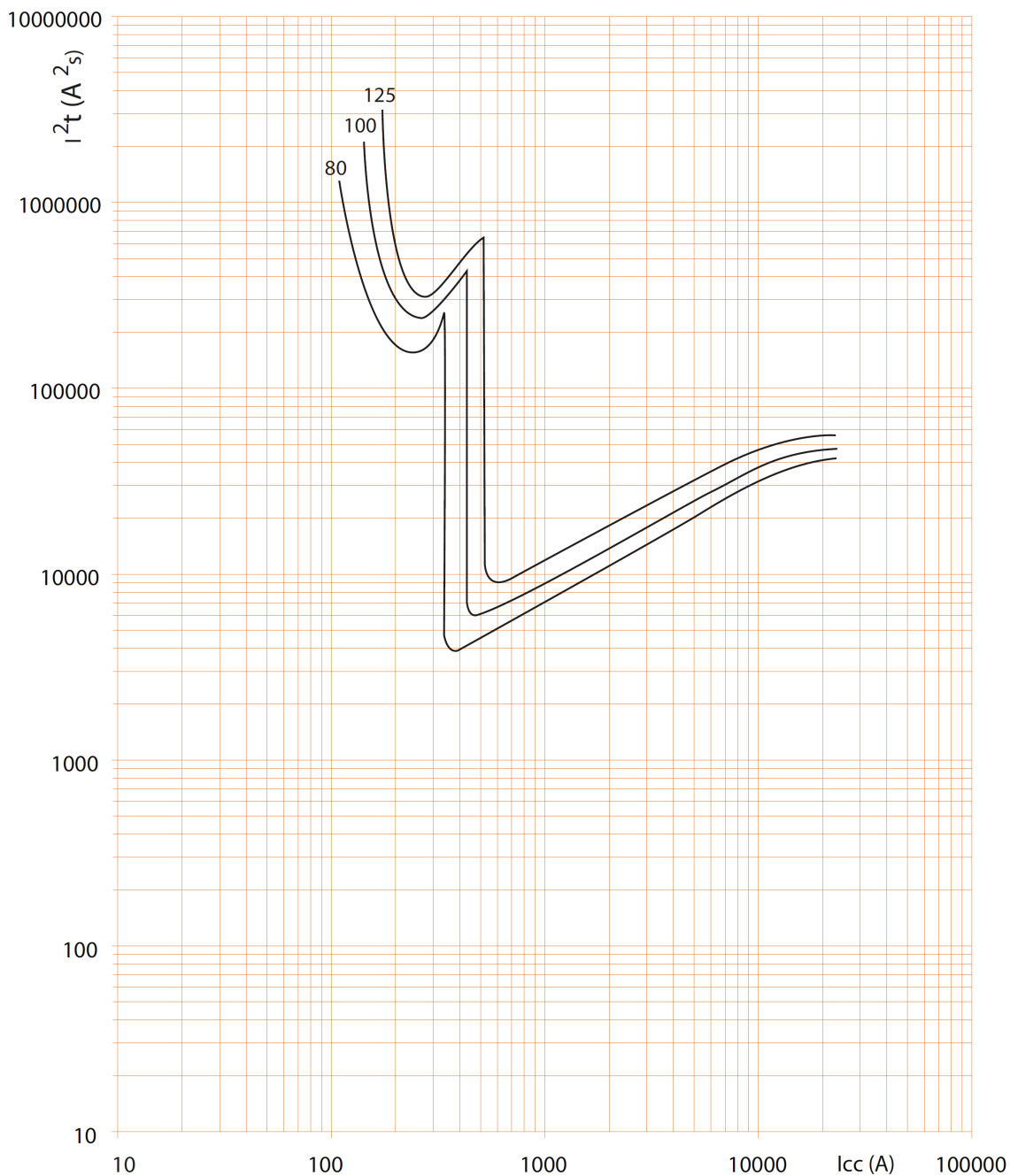

. Icc = Square value of symmetric component of the short circuit current (kA).
. I²t = Thermal energy limited (A²s).

DX³ MCB 25kA 80A to 125A (1,5 modules per pole)

Cat N°(s): 4 097 49 to 51, 4 097 62 to 64, 4 097 75 to 77,
4 097 88 to 90, 4 098 01 to 03, 4 098 14 to 16, 4 098 40 to
42, 4 098 53 to 55

7. CURVES (continued)

Operating characteristic of circuit breakers C curve:

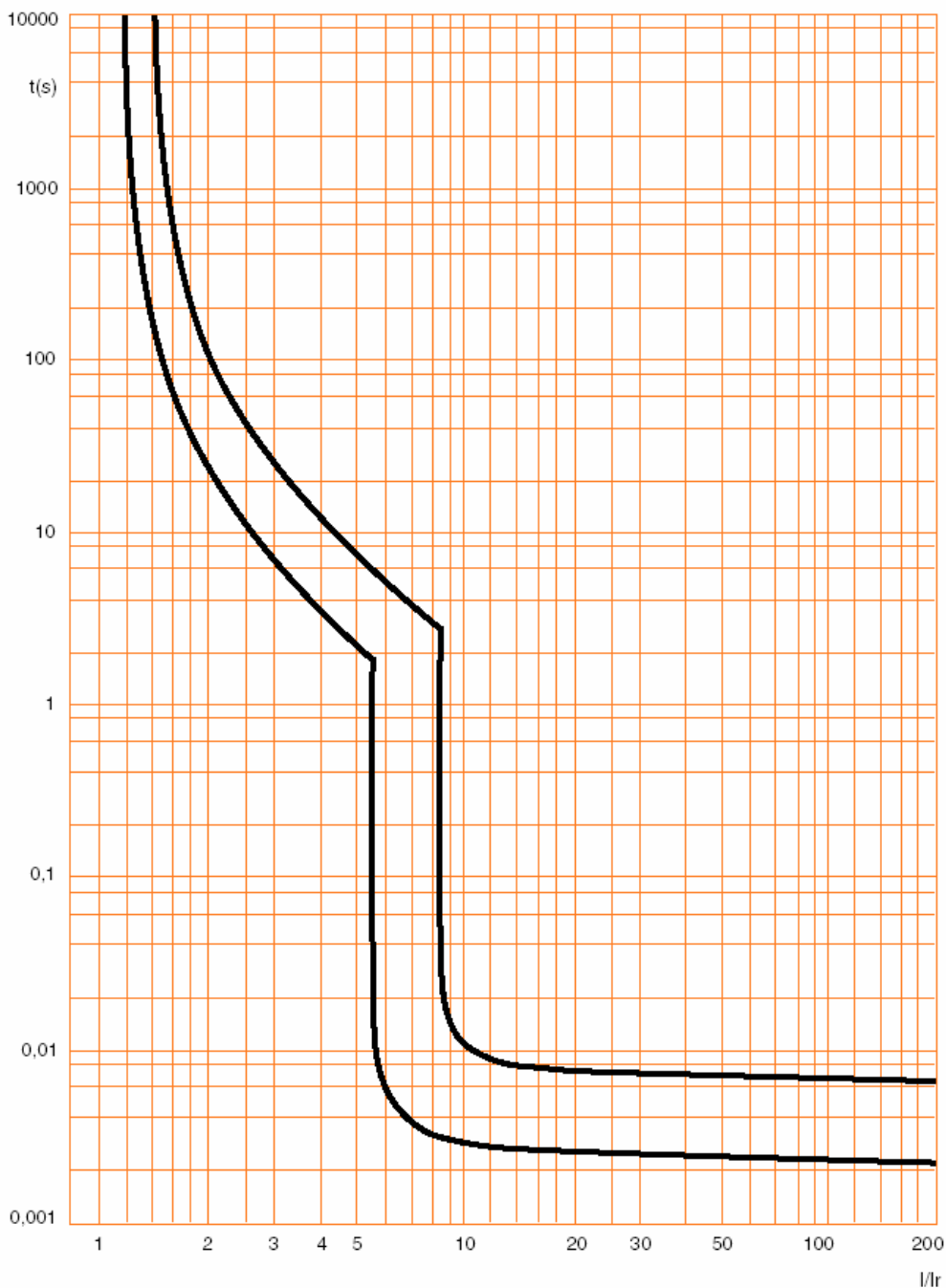

DX³ MCB 25kA 80A to 125A (1,5 modules per pole)

Cat N°(s): 4 097 49 to 51, 4 097 62 to 64, 4 097 75 to 77,
4 097 88 to 90, 4 098 01 to 03, 4 098 14 to 16, 4 098 40 to
42, 4 098 53 to 55

7. CURVES (continued)

. Thermal energy limiting curves of circuit breakers C curve, 2P (230V~ / 50Hz) :

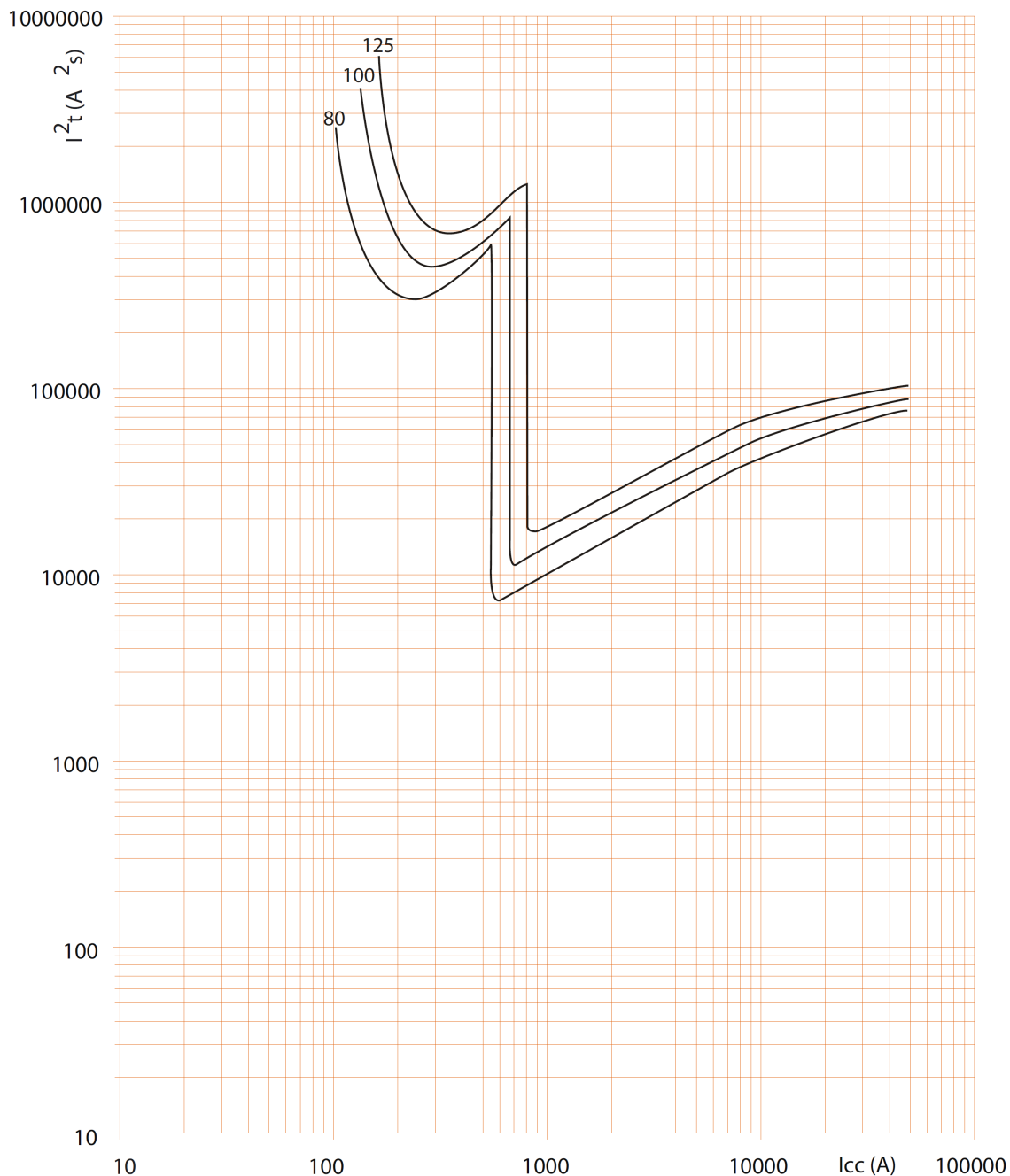

. Icc = Square value of symmetric component of the short circuit current (kA).
. I²t = Thermal energy limited (A²s).

DX³ MCB 25kA 80A to 125A (1,5 modules per pole)

Cat N°(s): 4 097 49 to 51, 4 097 62 to 64, 4 097 75 to 77,
4 097 88 to 90, 4 098 01 to 03, 4 098 14 to 16, 4 098 40 to
42, 4 098 53 to 55

7. CURVES *(continued)*

. Thermal energy limiting curves of circuit breakers curve C, 2P (400V~ / 50Hz) :

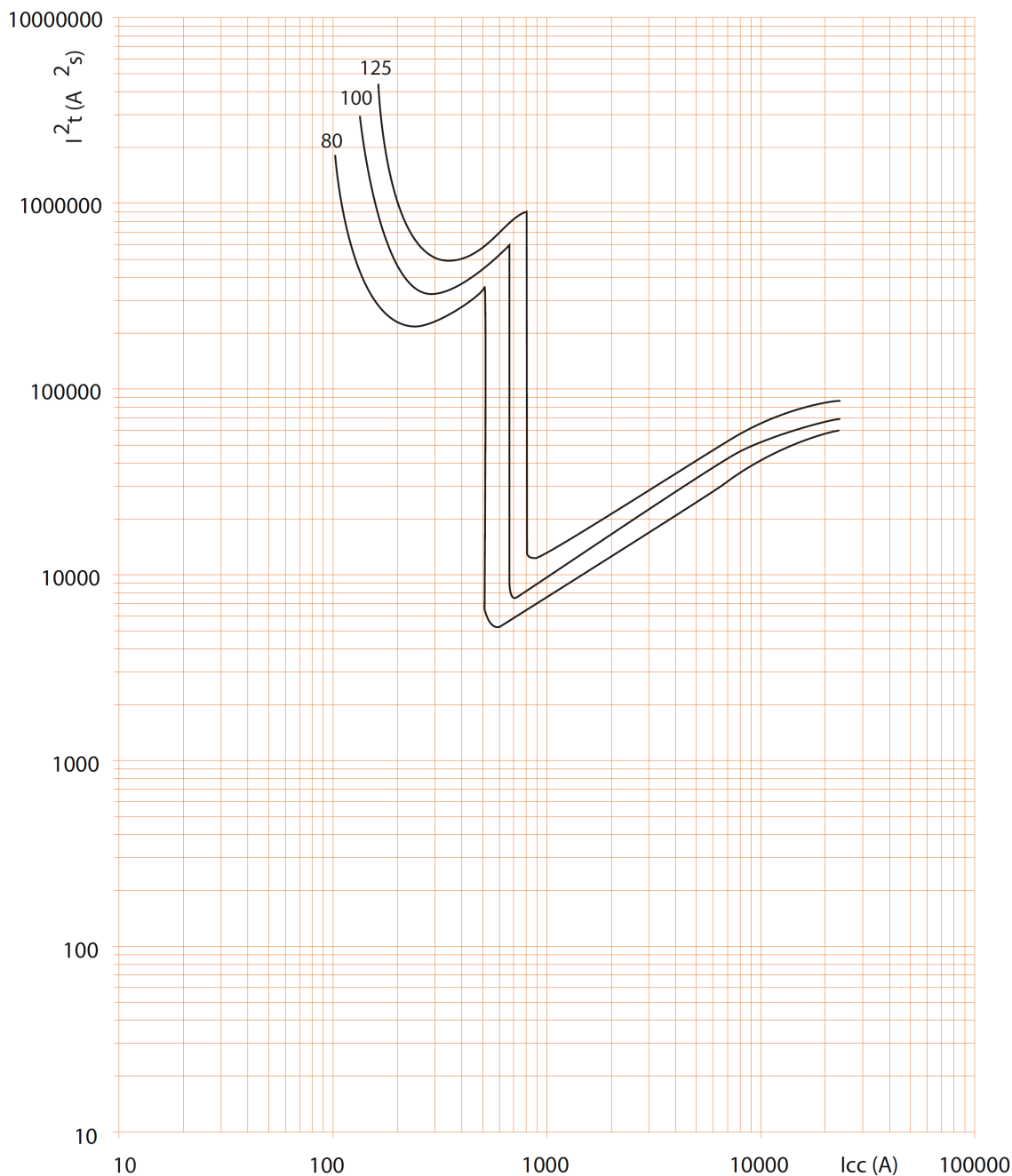

. Icc = Square value of symmetric component of the short circuit current (kA).
. I²t = Thermal energy limited (A²s).

DX³ MCB 25kA 80A to 125A (1,5 modules per pole)

Cat N°(s): 4 097 49 to 51, 4 097 62 to 64, 4 097 75 to 77,
4 097 88 to 90, 4 098 01 to 03, 4 098 14 to 16, 4 098 40 to
42, 4 098 53 to 55

7. CURVES (continued)

. Thermal energy limiting curves of circuit breakers C curve, 1P / 3P / 4P (400V~ / 50Hz) :

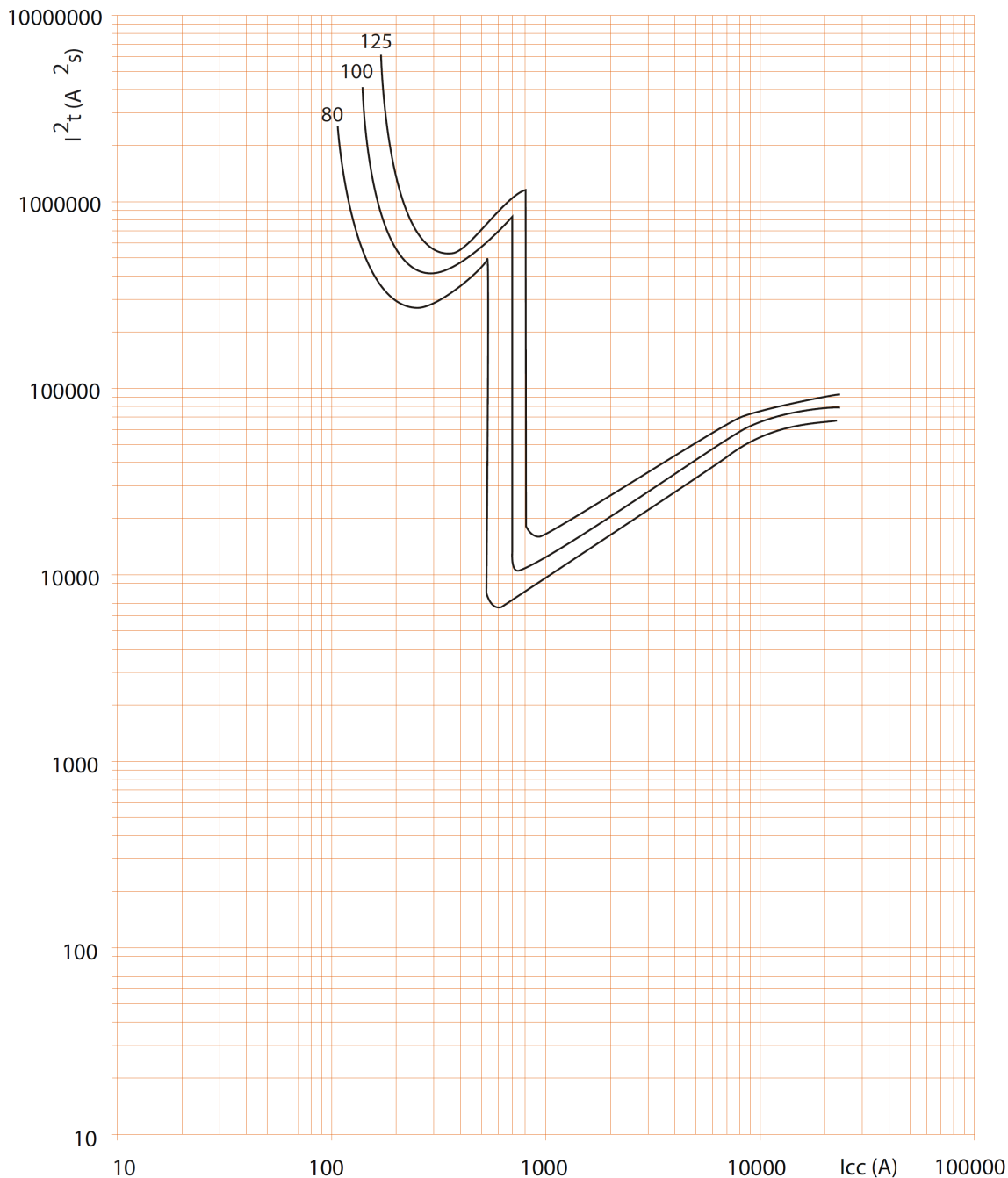

. Icc = Square value of symmetric component of the short circuit current (kA).
. I²t = Thermal energy limited (A²s).

DX³ MCB 25kA 80A to 125A (1,5 modules per pole)

Cat N°(s): 4 097 49 to 51, 4 097 62 to 64, 4 097 75 to 77,
4 097 88 to 90, 4 098 01 to 03, 4 098 14 to 16, 4 098 40 to
42, 4 098 53 to 55

7. CURVES (continued)

Operating characteristic of circuit breakers D curve:

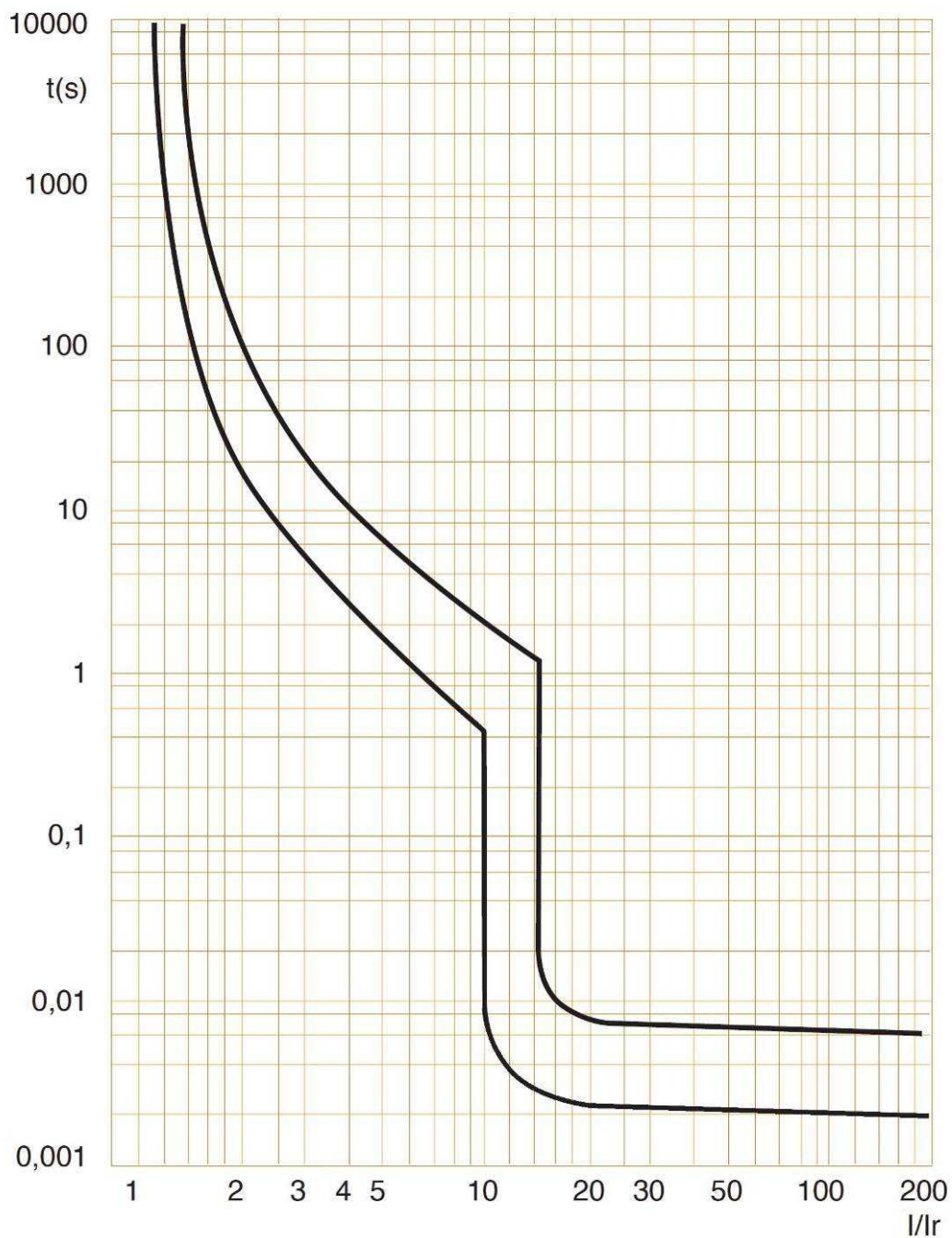

DX³ MCB 25kA 80A to 125A (1,5 modules per pole)

Cat N°(s): 4 097 49 to 51, 4 097 62 to 64, 4 097 75 to 77,
4 097 88 to 90, 4 098 01 to 03, 4 098 14 to 16, 4 098 40 to
42, 4 098 53 to 55

7. CURVES (continued)

. Thermal energy limiting curves of circuit breakers D curve, 3P / 4P (400V~ / 50Hz) :

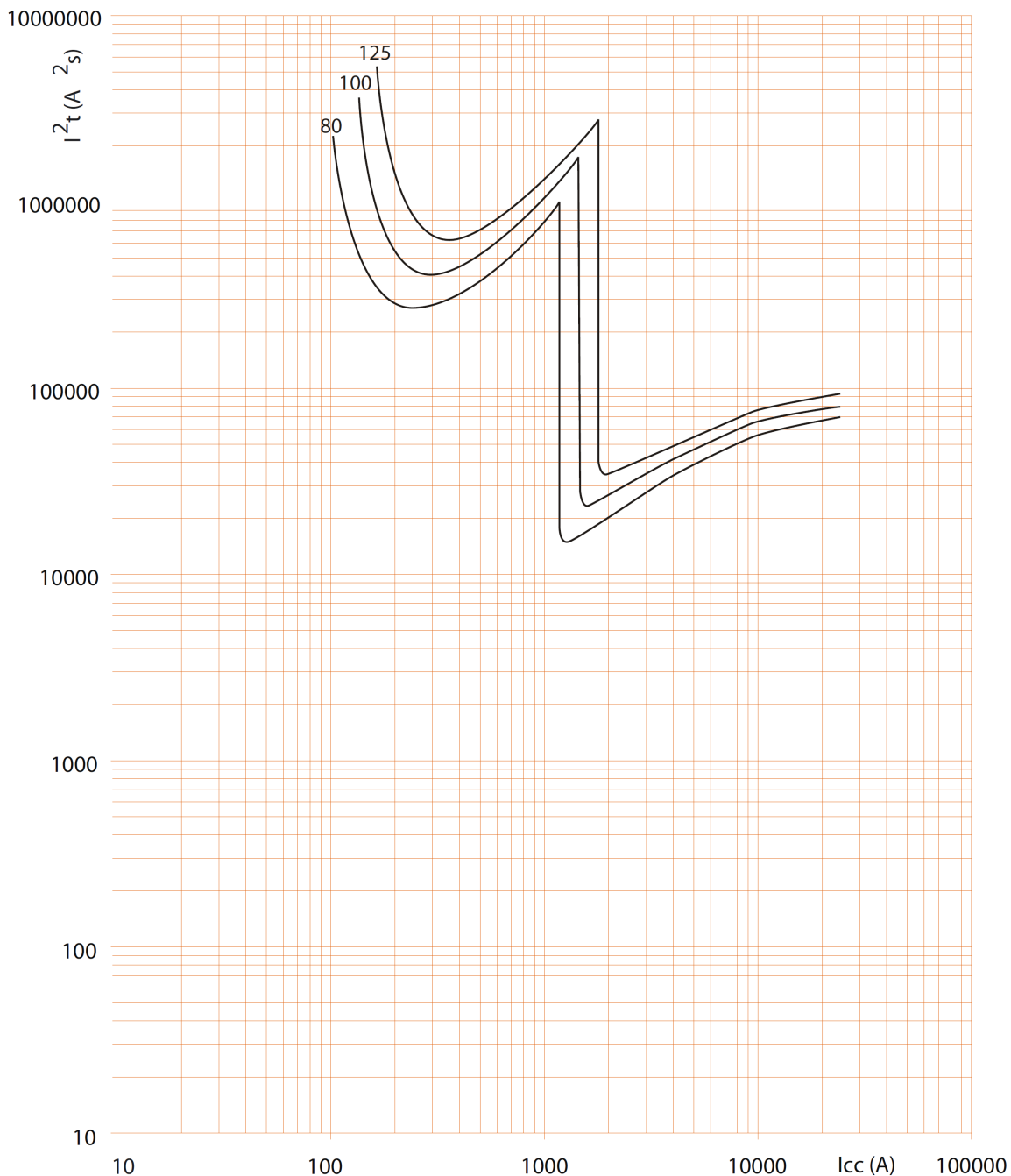

. I_{cc} = Square value of symmetric component of the short circuit current (kA).
. I^2t = Thermal energy limited (A²s).

DX³ MCB 25kA 80A to 125A (1,5 modules per pole)

Cat N°(s): 4 097 49 to 51, 4 097 62 to 64, 4 097 75 to 77,
4 097 88 to 90, 4 098 01 to 03, 4 098 14 to 16, 4 098 40 to
42, 4 098 53 to 55

8. AUXILIARIES AND ACCESSORIES

Add-on modules 125 A :

mcb	Add on module		
	2P	3P	4P
2P	X	-	-
3P	-	X	-
4P	-	-	X

Wiring accessories:

- . Sealable screw cover (cat n° 4 063 06).
- . Insulating shields (cat n° 4 063 12)
- . Aluminium terminal 95 mm² max (cat. n° 4 063 11)

Signal auxiliaries:

- . Auxiliary contact (½ module – cat n° 4 062 58).
- . Fault signalling changeover switch (½ module – cat n° 4 062 60).
- . Auxiliary contact modifiable in default signal (½ module – cat n° 4 062 62).
- . Auxiliary contact + fault signalling switch - can be modified to 2 auxiliary contacts (1 module - cat n° 4 062 66).

Control auxiliaries:

- . Shunt releases (1 module - cat n°. 4 062 76 / 78).
- . Under voltage release (1 module - cat n° 4 062 80 / 82).
- . Autonomous shunt trip for NC push-button (1 module - cat n°. 4 062 87).

Possible combinations of auxiliaries and MCBs:

- . The auxiliaries are installed to the left of the MCBs
- . Maximum number of auxiliaries = 3
- . Maximum number of 1 module signalling auxiliaries = 2
- . Maximum number of control auxiliaries (Cat. Nos. 4 062 76 to 4 062 87) = 1
- . The control auxiliary (Cat. Nos. 4 062 76 to 4 062 87) must mandatorily be placed to the left of the signalling auxiliaries (Cat. Nos. 4 062 58 to 4 062 66) where the auxiliaries from these 2 families are connected to the same MCB.

Sealing:

- . Possible in "Open" mode (OFF) or "Close" mode (ON).

Locking options:

- . By padlock (cat. n° 4 063 13 or 0 227 97), whit padlock support (cat. n° 4 063 03)

Installation software:

- . XL PRO³