CONTENT

1. OVERALL DESCRIPTION	1
2. PRODUCT RANGES	1
2.1 Surface mounting configurations	1
2.2 Flush mounting configurations	2
2.3 Faceplate configurations	2
3. DIMENSIONS	2
3.1 Surface mounting version	2
3.2 Flush mounting version	3
4. GENERAL FEATURES	3
4.1 Technical properties	3
4.2 Materials	3
Painting Characteristics	3
Salt spray resistance	4
Climatic conditions:	4
5. CONFORMITY AND APPROVALS	4
6. EQUIPMENT AND ACCESSORIES	4
6.1 Equipment	4
6.2 Ground connection	5
6.3 Mounting brackets installation	5
6.4 Joining kit installation	6
6.5 Dry wall installation	7
6.6 Knockouts size and number	7
6.7 Accessories	8
DOORS	8

1. OVERALL DESCRIPTION

The enclosures XL3 S 160 are cabinets with a particular "all modular ready to re-use configuration".

Wide range of setups: 2 to 8 rows of 24 modules and 4 to 8 rows of 36 modules that comes with rails and mounted faceplates. Available in 2 metal versions, surface mounting cabinets and flush mounting cabinets.

- Compatible with DRX 125, DPX³, MCBs
- Height adjustment of rail position
- Large faceplate
- High capacity
- Monobloc enclosures
- Flexibility for terminals connection (neutral/ground)
- Joining one above the other

2. PRODUCT RANGES
2.1 Surface mounting configurations

Cat. No (s)	No of rows	No of modules	Total No of modules	Weight (kg)
3 372 02	2	24	48	9,374
3 372 03	3	24	72	12,02
3 372 04	4	24	96	14,626
3 372 05	5	24	120	17,386
3 372 06	6	24	144	20,14
3 372 07	7	24	168	23,03
3 372 08	8	24	192	25,02
3 372 14	4	36	144	18,37
3 372 15	5	36	180	21,57
3 372 16	6	36	216	22,31
3 372 17	7	36	252	23,5
3 372 18	8	36	288	27,33

2.2 Flush mounting configurations

Cat. No (s)	No of rows	No of modules	Total No of modules	Weight (kg)
3 372 22	2	24	48	11,76
3 372 23	3	24	72	14,48
3 372 24	4	24	96	17,57
3 372 25	5	24	120	20,23
3 372 26	6	24	144	23,44
3 372 27	7	24	168	26,30
3 372 28	8	24	192	29,2
3 372 34	4	36	144	21,31
3 372 35	5	36	180	22,15
3 372 36	6	36	216	28,66
3 372 37	7	36	252	32,13
3 372 38	8	36	288	36,8

2.3 Faceplate configurations

Item size	No of faceplates	Configuration of faceplates
2 rows	1	1x2 rows
3 rows	1	1x3 rows
4 rows	1	1x4 rows
5 rows	1	1x5 rows
6 rows	2	2x3 rows
7 rows	2	1x4 rows+1x3 rows
8 rows	2	2x4 rows

3. DIMENSIONS

3.1 Surface mounting version

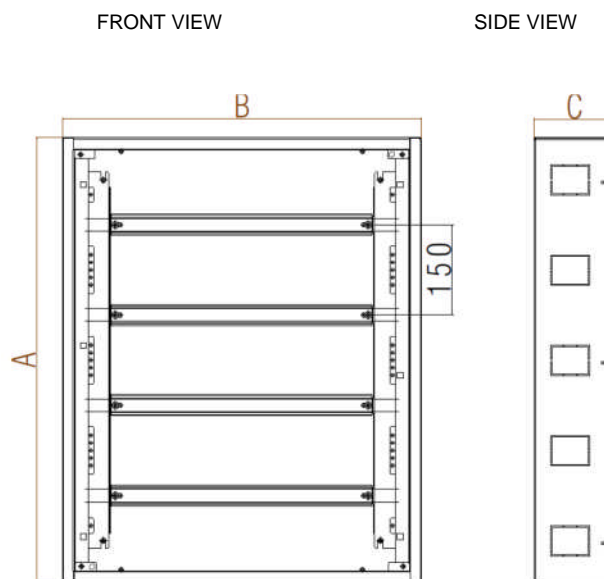

Cat. No(s)	A	B	C
3 372 02	440	595	135
3 372 03	590	595	135
3 372 04	740	595	135
3 372 05	890	595	135
3 372 06	1040	595	135
3 372 07	1190	595	135
3 372 08	1340	595	135
3 372 14	740	810	135
3 372 15	890	810	135
3 372 16	1040	810	135
3 372 17	1190	810	135
3 372 18	1340	810	135

3.2 Flush mounting version

SIDE VIEW

FRONT VIEW

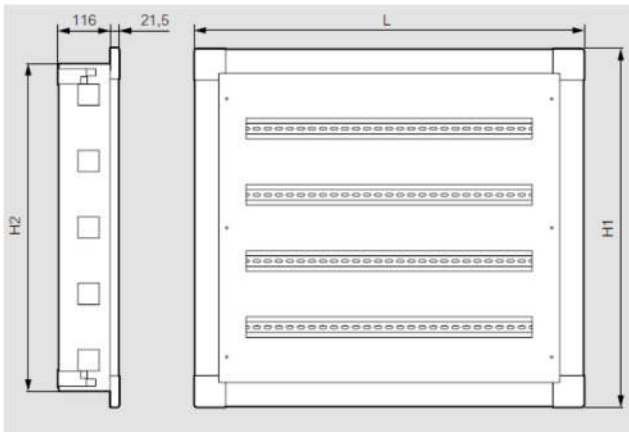

Cat n°s	H1	H2	L
3 372 22	512	440	667
3 372 23	662	590	667
3 372 24	812	740	667
3 372 25	962	890	667
3 372 26	1112	1040	667
3 372 27	1262	1190	667
3 372 28	1412	1340	667
3 372 34	812	740	883
3 372 35	962	890	883
3 372 36	1112	1040	883
3 372 37	1262	1190	883
3 372 38	1412	1340	883

4. GENERAL FEATURES

4.1 Technical properties

- Degree of protection : IP30 - IK07 without door
IP40 - IK09 with door
IP40 - IK08 with glass door
- Color of the cabinet : White RAL 9003
- Short-circuit Intensity Icc 17 kA
- Storage and usage temperatures: -5 °C to +40°C
- Maximum permissible current 160 A
- Uimp: 4kV
- Ue: 415v
- Ui: 500V

4.2 Materials

- Frontal panel : steel 1.2 mm thickness
- Door : steel 1.2 mm thickness
- Chassis : steel 1 mm thickness
- Adjustment bracket :
Self-extinguishing polycarbonate
reinforced with 10% glass fiber >PC-GF10 FR<
UL 94 / IEC 60695-11-10 classification
(thickness 0,8; 1,6; 3,2 mm) - ;V1 ;V2

Painting Characteristics

- Painting: epoxy polyester powder. Minimum thickness 60µ
- Grain size distribution (Ø average) ISO 8130-1: 32 µm 36÷46%; 63 µm 74÷91%
 - Scratch test UNI 9395: invisible scratch (0.4 kg)
 - Cross-cut test ISO 2409: GT0...1
 - Overheating resistance (DYI (190°C, 60') ASTM D 1925): >1,5

After 10 minutes contact, at ambient temperature, with the following substances the coating remains intact:

- methyl Alcohol
- Toluene
- Xylene
- Chloridric Acid
- Gas oil
- Gasoline
- NaOH 30% (caustic soda, aqueous solution)

After 1 week contact, at ambient temperature, with the following substances the coating remains intact:

- bleach 15% active chlorine
- saturated solution bleach
- Ethylic alcohol and N – hexane resistance as define in the standard UNI 9852.

After 1 month immersion, at ambient temperature, in the following aqueous solutions the coating remains intact:

- 1% standard detergent
- 10% sodium chloride
- 1% citric acid
- 5% phosphoric acid
- 10% ammonia
- xylene
- 20% acetic acid

After 6 months immersion, at ambient temperature, in the following aqueous solutions the coating remains intact:

distilled water

normal water

Salt spray resistance

500 hours without blistering neither detachment of paint, applied on the pretreated panel with iron phosphate salts.

The painting cycle and materials allow a resistance up to level "C4 Low" according to standard ISO 12944.

It is possible to arrive up to a level "C5 medium" with a dedicate painting cycle.

Climatic conditions:

Operating temperature : -5°C to + 40° C

Stocking temperature: - 10°C to + 70°C

5. CONFORMITY AND APPROVALS

Conform with standards: IEC 61439-2

Fire resistance according to IEC 60695-2-1 750°C/5s

6. EQUIPMENT AND ACCESSORIES

6.1 Equipment

The cabinets are suitable for installation of different types of equipments:

- DPX³
- DRX
- Modular switches (MCB)

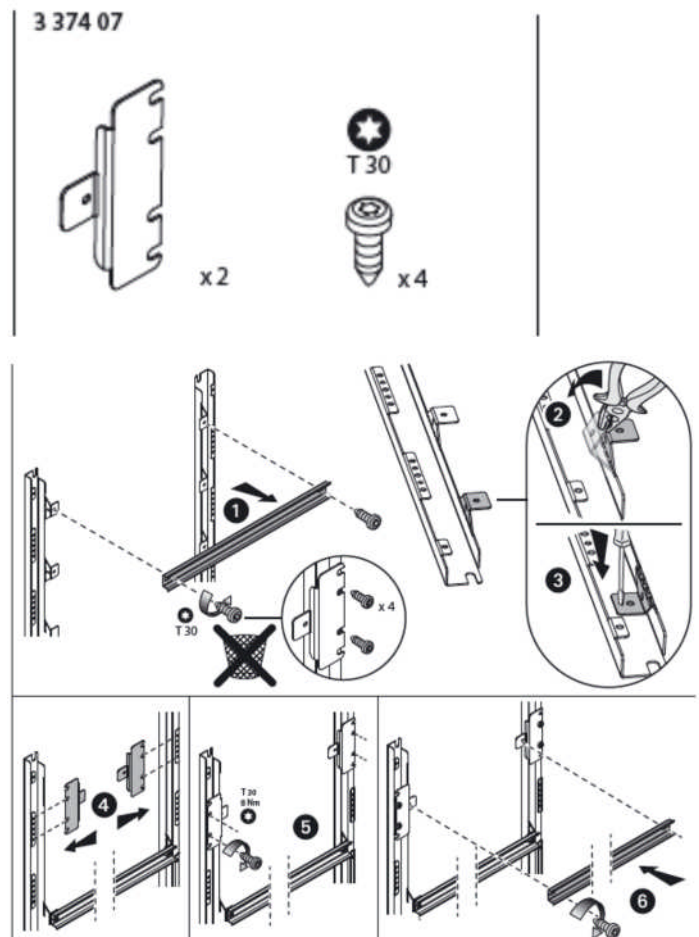
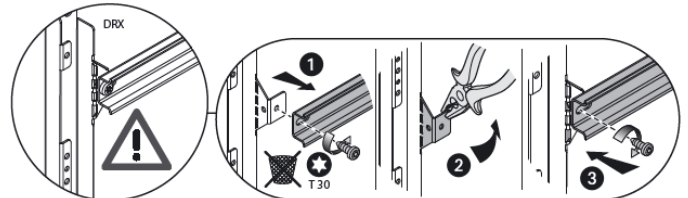

6.2 Ground connection

Provided with the support for the ground connection.

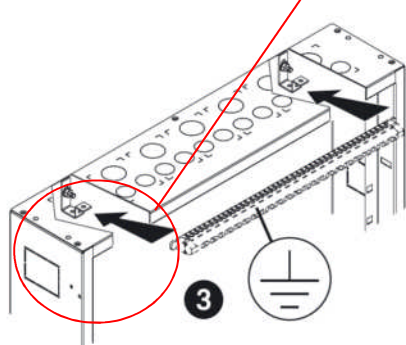

6.3 Mounting brackets installation

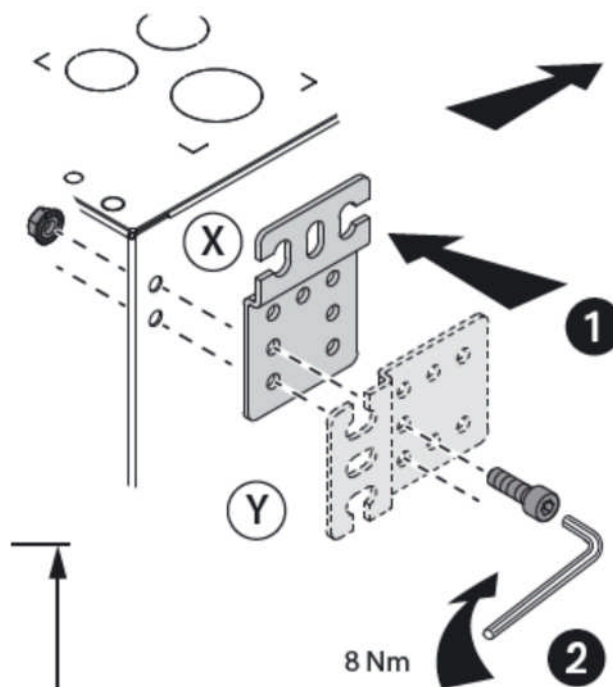
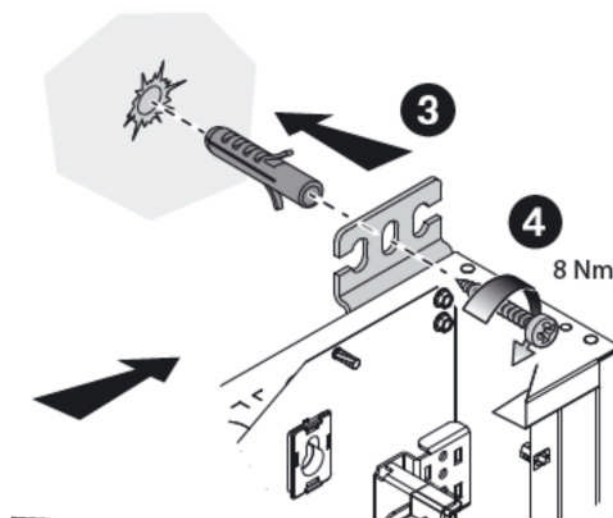
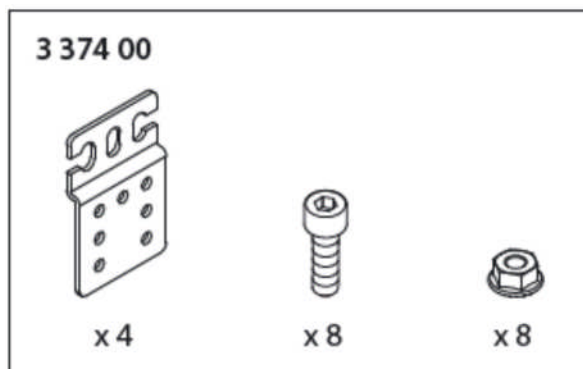

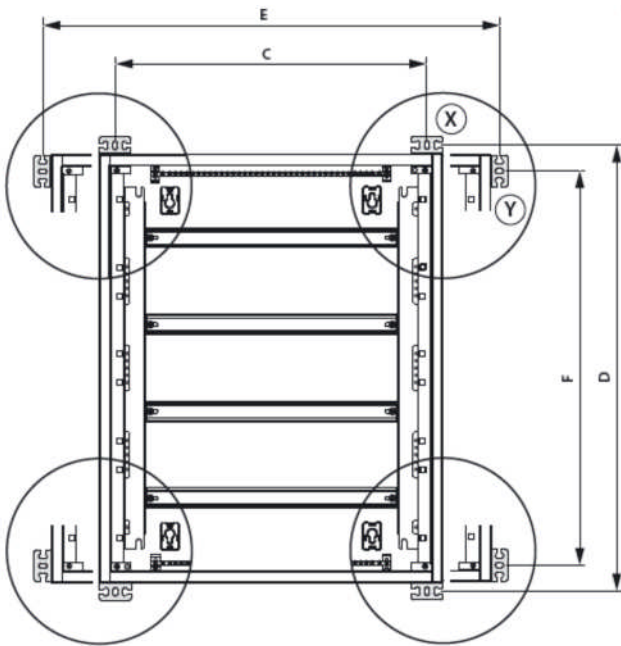

		C	D	E	F
24M	3 372 02	540	468	625	383
	3 372 03		618		533
	3 372 04		768		683
	3 372 05		918		833
	3 372 06		1068		983
	3 372 07		1218		1133
	3 372 08		1368		1283
36M	3 372 14	756	768	841	683
	3 372 15		918		833
	3 372 16		1068		983
	3 372 17		1218		1133
	3 372 18		1368		1283

6.4 Joining kit installation

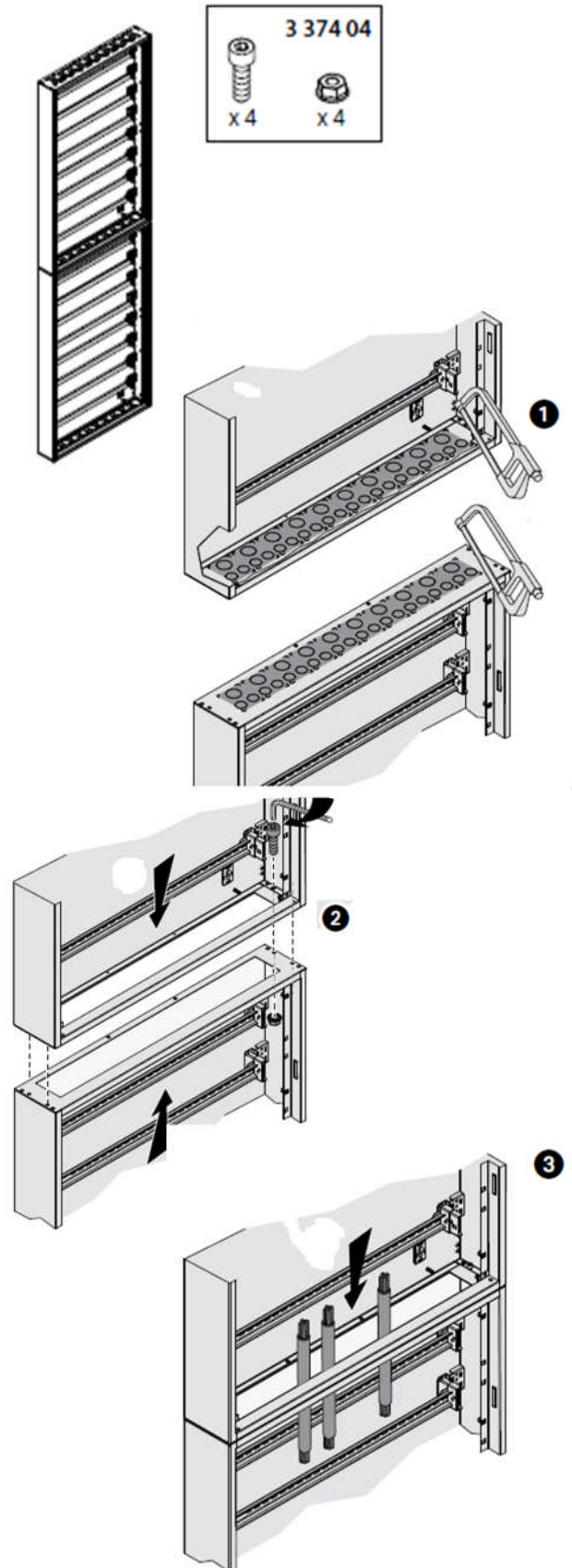

6.5 Dry wall installation

With specific accessory the enclosure can be fixed in dry walls.

The accessory is composed by a set of fixing supports and the fixing screws (fixing screws for drywall not included).

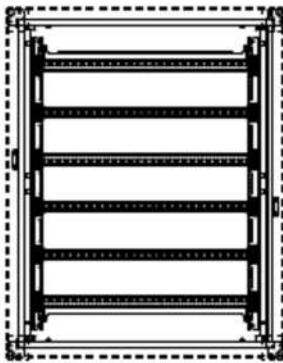
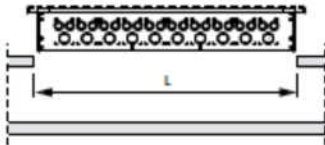
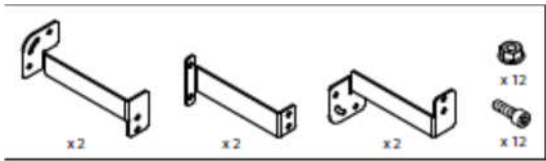

	L	H	P
2 x 24M	610	450	> 120
3 x 24M		600	
4 x 24M		750	
5 x 24M		900	
6 x 24M		1050	
7 x 24M		1200	
8 x 24M		1350	
2 x 36M		825	
3 x 36M	600		
4 x 36M	750		
5 x 36M	900		
6 x 36M	1050		
7 x 36M	1200		
8 x 36M	1350		

6.6 Knockouts size and number

ISO DIAMETER

Number of modules	Circular knockouts number and diameter
24	14 (25,4 mm)
	7 (32,5 mm)
36	20 (25,4 mm)
	10 (32,5 mm)

Number of modules	Rectangular knockouts number and dimensions
24	7 (62 x 80) mm
36	10 (62 x 80) mm

6.7 Accessories

DOORS

- Completely reversible door
- Opening angle 130°
- Space between faceplate and door: 27.5mm

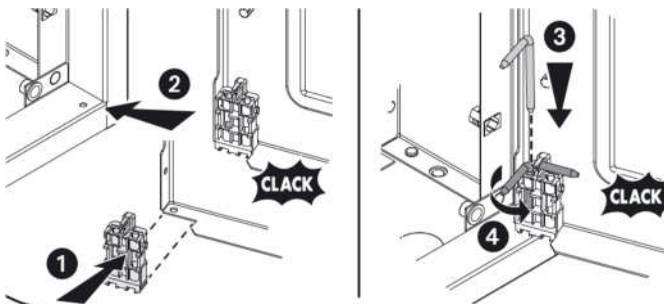
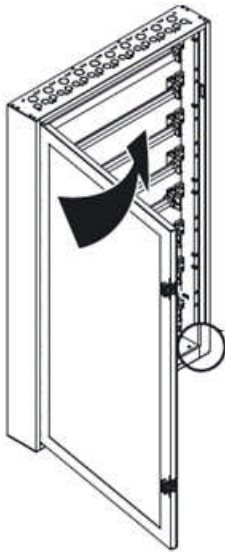
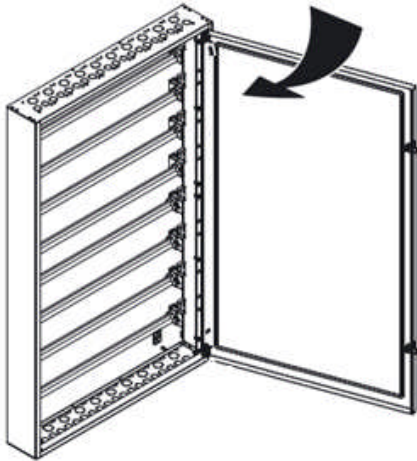

Metal doors

Cat n°s	Rows and modules	High	Width	N° of locks
3 372 52	2 x 24	394	547	1
3 372 53	3 x 24	544	547	1
3 372 54	4 x 24	694	547	1
3 372 55	5 x 24	844	547	1
3 372 56	6 x 24	994	547	1
3 372 57	7 x 24	1044	547	2
3 372 58	8 x 24	1194	547	2
3 372 64	4 x 36	694	747	1
3 372 65	5 x 36	844	747	1
3 372 66	6 x 36	994	747	1
3 372 67	7 x 36	1044	747	2
3 372 68	8 x 36	1194	747	2

Glass doors

Cat n°s	Rows and modules	High	Width	N° of locks
3 372 72	2 x 24	394	547	1
3 372 73	3 x 24	544	547	1
3 372 74	4 x 24	694	547	1
3 372 75	5 x 24	844	547	1
3 372 76	6 x 24	994	547	1
3 372 77	7 x 24	1044	547	2
3 372 78	8 x 24	1194	547	2
3 372 84	4 x 36	694	747	1
3 372 85	5 x 36	844	747	1
3 372 86	6 x 36	994	747	1
3 372 87	7 x 36	1044	747	2
3 372 88	8 x 36	1194	747	2