

Niloé™
TV terminal and connecting sockets

Cat. Nos: 7 645 52/55 - 7 646 52/55 - 7 647 52/55

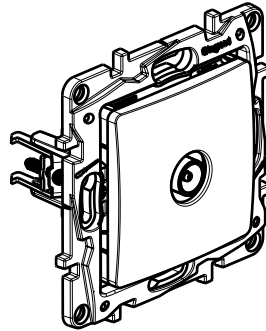

1. USE

Male TV Ø 9.52 mm terminal and connecting sockets.
 Recommended cable 17/19 VATC
 Compatible with UHD terrestrial TV
 Class A
 0-862 MHz

2. RANGE

Item	Colour		
	Ivory	White	Brown
14 dB male TV Ø 9.52 mm connecting socket	7 645 52	7 646 52	7 647 52
10 dB male TV Ø 9.52 mm terminal socket	7 645 55	7 646 55	7 647 55

3. DIMENSIONS (mm)

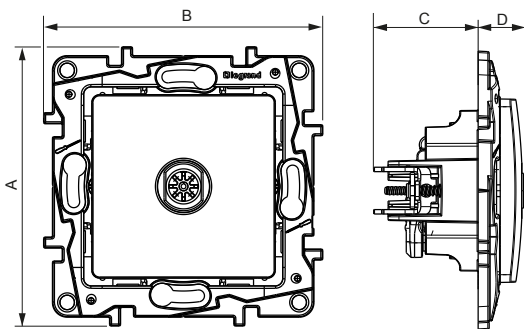

Cat. Nos.	A	B	C	D
7 645 52/55 - 7 646 52/55 - 7 647 52/55	75,8	75,8	28,3	12,3

4. CONNECTION

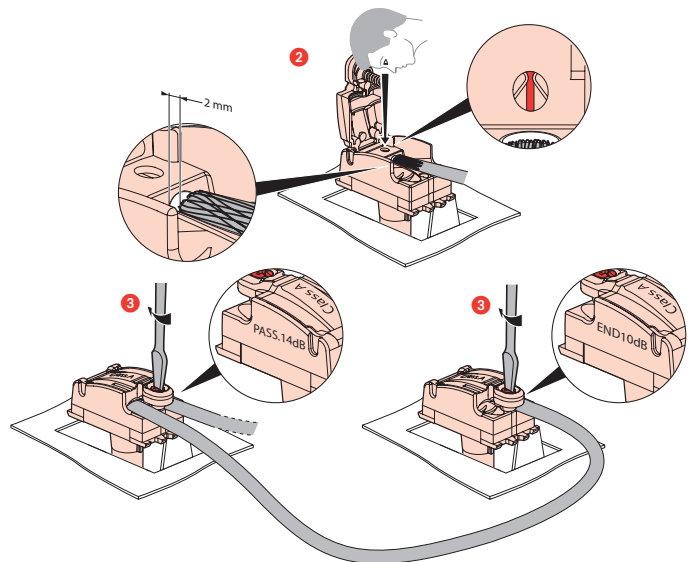

5. WIRING PRECAUTIONS

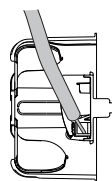
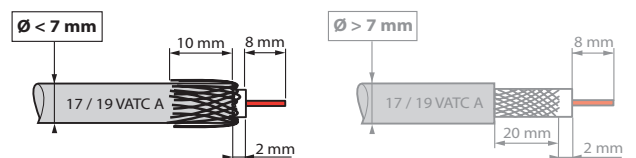

By restricting deformation of the coaxial cable, the rear connection avoids impedance discontinuity, thereby sustaining performance.

6. TECHNICAL CHARACTERISTICS

■ **6.1 Mechanical characteristics**

Protection against solid bodies and liquids: IP 21
 Protection against impacts: IK 04
 Cable resistance 120 N: standard IEC 61169-24

■ **6.2 Material characteristics**

Casing: Poly gloss appearance

Colour: - White RAL 903

Material: - Plate: ABS/PC

- Cover plate: ABS

- Halogen-free

- UV resistant

Motor: - Box: zamac

- Cover: zamac

- Pin: bronze

- Screws: steel

■ **6.3 Electrical characteristics**

- Characteristic impedance: 75 Ohm

- Male connector Ø 9.52 mm

- Class A shielding efficiency (class A shielding is necessary to prevent interference caused by using new 3 and 4 G phone signals, as these unwanted signals can result in pixellation on screen or adversely affect the sound track).

- Frequency bands: TV : 0 - 862 MHz

- Insulation resistance: standard IEC 61169-24

■ **6.4 Climate characteristics**

Storage and operating temperature: -5°C to +35°C

7. CARE

Clean the surface with a cloth.

Do not use acetone, tar-removing cleaning agents or trichloroethylene.

Resistant to the following products: Hexane (EN 60669-1), methylated spirit, soapy water, diluted ammonia, bleach diluted to 10%, window-cleaning products, pre-impregnated wipes.

Caution: Always test before using special cleaning products.

8. STANDARDS AND APPROVALS

- EN 50083-2
- EN 50083-4
- Class A certificate

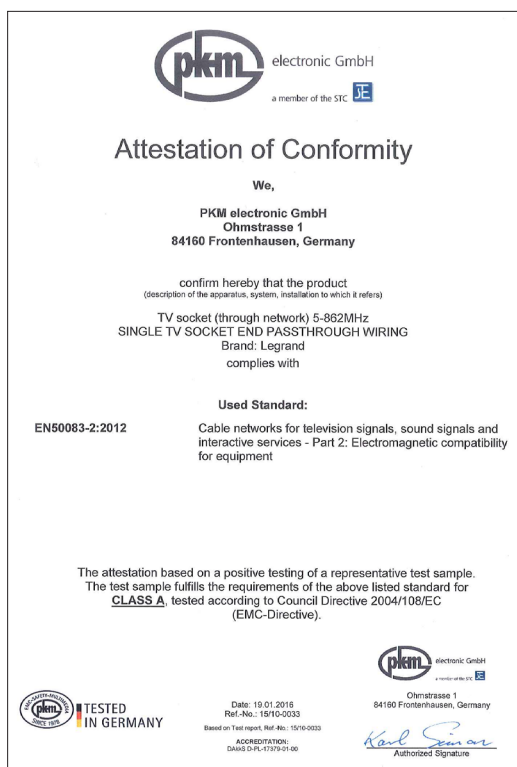
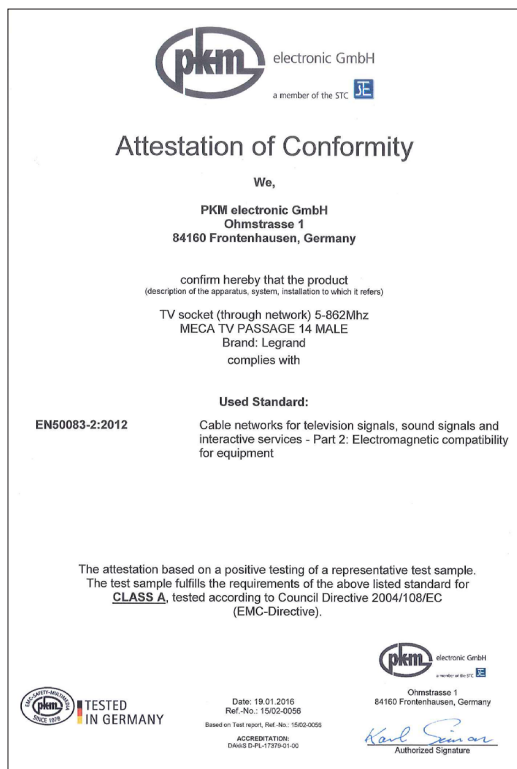

9. PERFORMANCE

Pass through TV socket

End TV socket

