

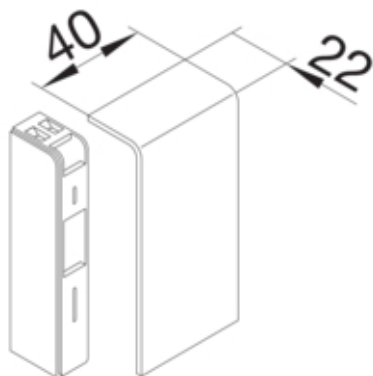

Placa de capat SL20080, fag

SL200806D2



Arhitectura

Tip de montaj	Blocat
---------------	--------

Materiale

Culoare	fag
Material	PC - ABS fara continut de halogen
Grup materiale	Plastic
Suprafata	imprimat

Dimensiuni

Înaltimea canalului	80 mm
Latimea canalului	20 mm

Montare

Deschidere capac de montare	Nu
Folie de protectie	Nu

Echipament

Casurare de taiere	Da
--------------------	----

Utilizare

Tip produs	Piesa de capat
------------	----------------

Standarde

Autorizatii	CE
Conform directivelor europene RoHs	conformitate voluntara

Protectie

Fara halogen	da
--------------	----

Conditii de utilizare

Temperatura de regim	-5/65 °C
----------------------	----------