

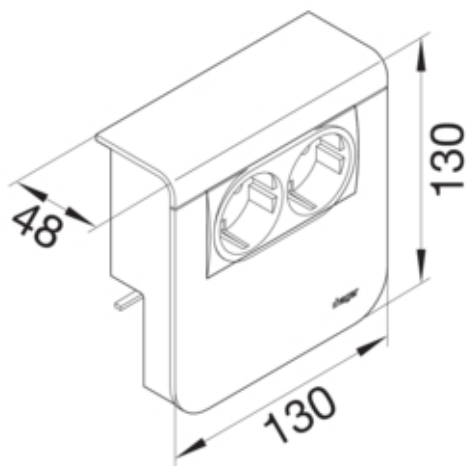

Priza SCHUKO difuzor SL20080, aluminiu

SL20080923D1



Arhitectura

Tip de montaj	Blocat si înfiletat
---------------	---------------------

Configuratie

Doza	Nu
------	----

Compatibilitate

Format posibilitate de montare a echipamentului	deja asamblat
---	---------------

Principalele caracteristici electrice

Tensiune nominala	230 V
-------------------	-------

Materiale

Culoare	aluminiu optic
Culoare	Aluminiu
Material	Plastic
Grup materiale	material mixt
Suprafata	lacuit

Dimensiuni

Adâncimea produsului instalat	48 mm
Înaltimea produsului instalat	130 mm
Lungime	130 mm
Înaltimea canalului	80 mm
Latimea canalului	20 mm
Format	Montare echipamente

Accesorii incluse

preechipat cu	Priza + difuzor
---------------	-----------------

Echipament

Numar unitati	2
---------------	---

Standarde

Autorizatii	CE
Conform directivelor europene RoHs	conformitate voluntara

Protectie

Fara halogen	da
--------------	----

Conditii de utilizare

Temperatura de regim	-5/65 °C
----------------------	----------

Identificare

Gama produse	SL
--------------	----