



































Pictogramele capului de tabel

 Curent nominal (A)	 Tensiune nominală (V)	 Note, completări	 Masa
 Numărul de șuruburi	 Filet	 Culoare	 Prese
 Profil semicerc	 Profil hexagonal	 Secțiunea conductorului de racord	 Diametrul conductorului
 Numărul de cleme	 Latura de alimentare	 Latura de derivație	 Plin, Lițat, Flexibil
 Domeniu de presare	 Număr de poli		

Pictogramele datelor tehnice

 Materialul elementului de legătură: Aluminiu	 Materialul elementului de legătură: Cupru stanat	 Materialul elementului de legătură: Alamă	 Materialul elementului de legătură: cupru electrolitic stanat
 Materialul elementului de legătură: cupru electrolitic	 Materialul izolației: Poliamidă 6.6	 Materialul izolației: Polietilenă	 Materialul izolației: Poliolefină
 Materialul izolației: Polipropilenă	 Materialul izolației: PVC	 Temperatura mediului ambiant	 Moment de strângere
 Se poate fixa pe sină de montaj	 Raport de contracție	 Grad de protecție	 Rezistență la foc conform UL 94
 Tensiunea nominală de izolare			

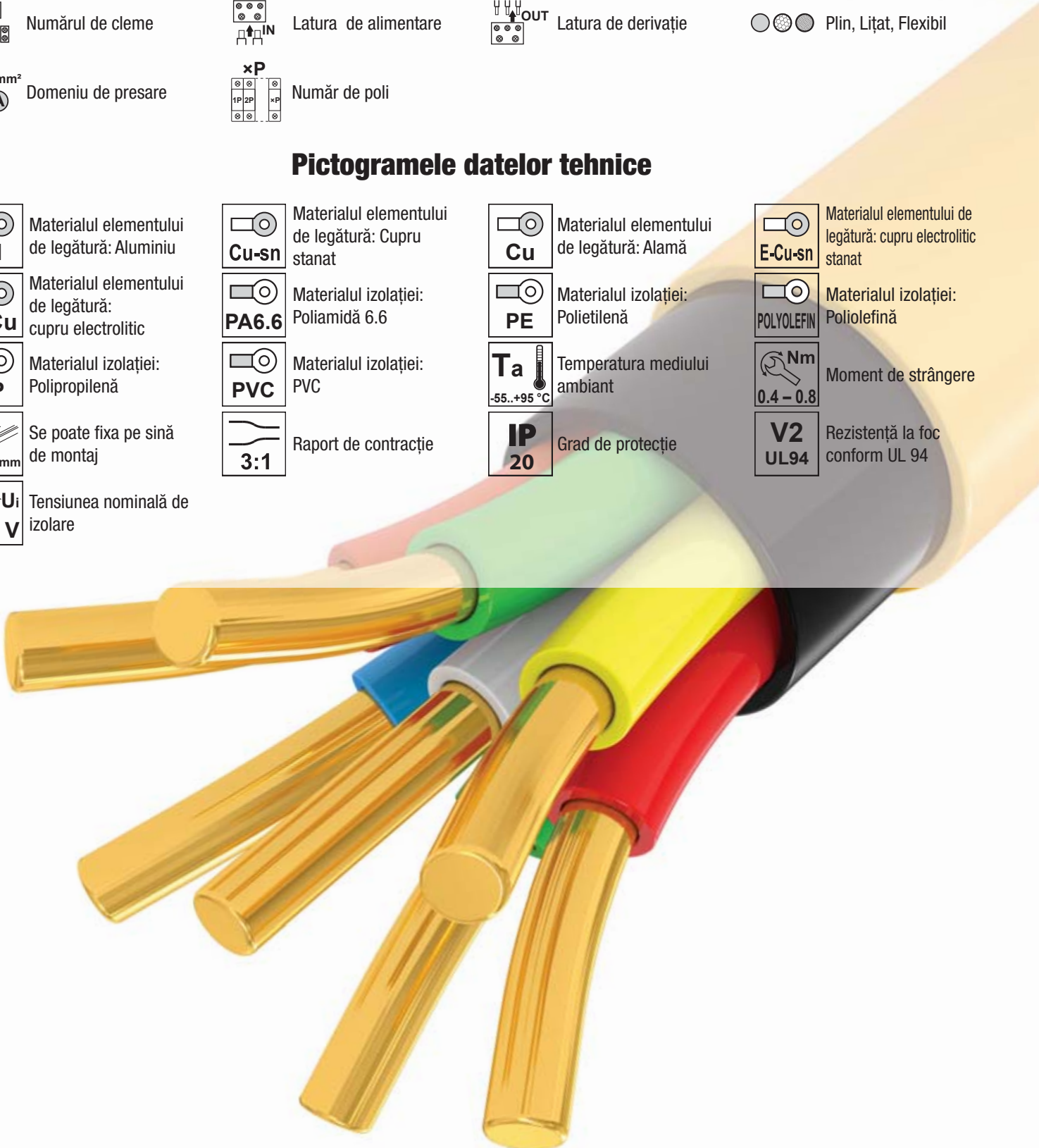



Papuci inelari neizolați 2



Papuci inelari neizolați din țevă 4



Papuci inelari prelungiți, din țevă de CU 5



Papuci inelari neizolați din Al 6



Papuci inelari neizolați Cu-Al 7



Papuci cu prindere prin șurub 7



Papuci tip furcă neizolați 8

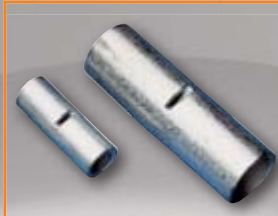

Mufe neizolate 9



Mufe neizolate Cu-Al 9

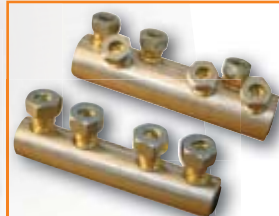

Mufe și papuci cu șurub având limitator de strângere 11



Izolații pentru papuci neizolați 12



Pastă de protecție și contact 12



Cleme de legătură cu șurub pentru realizarea derivațiilor 13



Papuci inelari izolați 14



Papuci tip furcă izolați 15



Papuci tip pin izolați 16



Mufe izolate 17

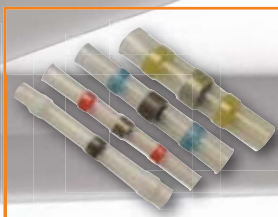

Manșon termocontractabil cu staniu 17



Fișe și mufe glisante 18



Tub de capăt (cap terminal) neizolat 22



Tub de capăt (cap terminal) izolat 23



Tub de capăt (cap terminal) dublu, izolat 24



Clemă de legături fără șurub, care poate fi deschisă 25



Cleme de legătură fără șurub 25

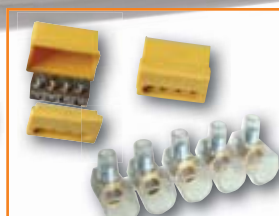

Cleme cu șurub pentru legături 26



Clemă șir distribuție 27

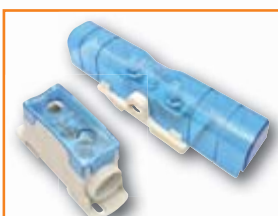

Clemă șir modulară pentru mufare, cu capac care se poate deschide 28

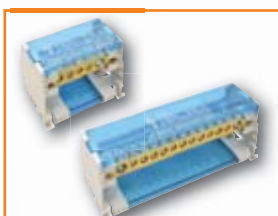

Distribuitoare modulare cu capac care se poate deschide 28

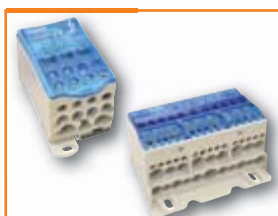

Clemă șir distribuție cu capac care se poate deschide 29

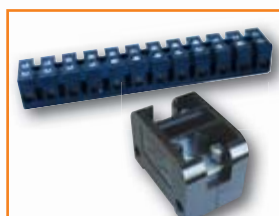

Cleme șir din bachelită 30



Cleme șir flexibile 31



Cleme șir, fără șurub (cu arc), tip TSKD 33



Cleme șir industriale tip TSKA 34



Cleme șir industriale, fără șurub, tip TSKB 38



Cleme șir, fără șurub (cu arc), tip TSKC 42

Papuci inelari neizolați

TRACON	d ₁ (mm)	d ₂ (mm)	D (mm)	L (mm)	B (mm)	mm ²				
						1.5-2.5	1.5-2.5	1-1.5		
SZ1.5-3	2.3	3.7	4	16	8.4					
SZ1.5-4	2.3	4.3	4	16	8.4					
SZ1.5-5	2.3	5.3	4	16	8.4					
SZ1.5-6	2.3	6.4	4	21.5	11.6	1.5-2.5	1.5-2.5	1-1.5		
SZ1.5-8	2.3	8.4	4	21.5	11.6					
SZ1.5-10	2.3	10.5	4	25.5	13.7					
SZ2.5-4	3	4.3	5	17.8	8					
SZ2.5-5	3	5.3	5	17.8	8					
SZ2.5-6	3	6.4	5	21	12	4-6	2.5-4	2.5-4		
SZ2.5-8	3	8.4	5	27.5	15					
SZ2.5-10	3	10.5	5	27.5	15					
SZ2.5-12	3	13	5	30.8	18.9					
SZ4-4	3.4	4.3	5.5	19	9.6					
SZ4-5	3.4	5.3	5.5	19.6	9.6					
SZ4-6	3.4	6.4	5.5	23	12	4-6	(2.5)4-6	(2.5)4-6		
SZ4-8	3.4	8.4	5.5	27.6	15					
SZ4-10	3.4	10.5	5.5	27.6	15					
SZ10-4	4.5	4.3	7.1	23.8	12					
SZ10-5	4.5	5.3	7.1	23.8	12					
SZ10-6	4.5	6.4	7.1	23.8	12	6-10	(4)6-10	4-6		
SZ10-8	4.5	8.4	7.1	29.7	15					
SZ10-10	4.5	10.5	7.1	29.7	15					
SZ10-12	4.5	13	7.1	32.8	19					
SZ16-5	5.8	5.3	9	28	12					
SZ16-6	5.8	6.4	9	28	12					
SZ16-8	5.8	8.4	9	32.2	16	16-25	10-16	6-10		
SZ16-10	5.8	10.5	9	32.2	16					
SZ16-12	5.8	13	9	40.9	22					
SZ25-5	7.7	5.3	11.5	33.7	16.4					
SZ25-6	7.7	6.4	11.5	33.7	16.4					
SZ25-8	7.7	8.4	11.5	33.7	16.4	25-35	16-25	10-16		
SZ25-10	7.7	10.5	11.5	36.7	17.4					
SZ25-12	7.7	13	11.5	42.6	22					
SZ35-6	9.4	6.4	13.5	42.8	22.1					
SZ35-8	9.4	8.4	13.5	42.8	22.1					
SZ35-10	9.4	10.5	13.5	42.8	22.1	50-70	35-50	25-35		
SZ35-12	9.4	13	13.5	42.8	22.1					

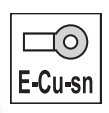
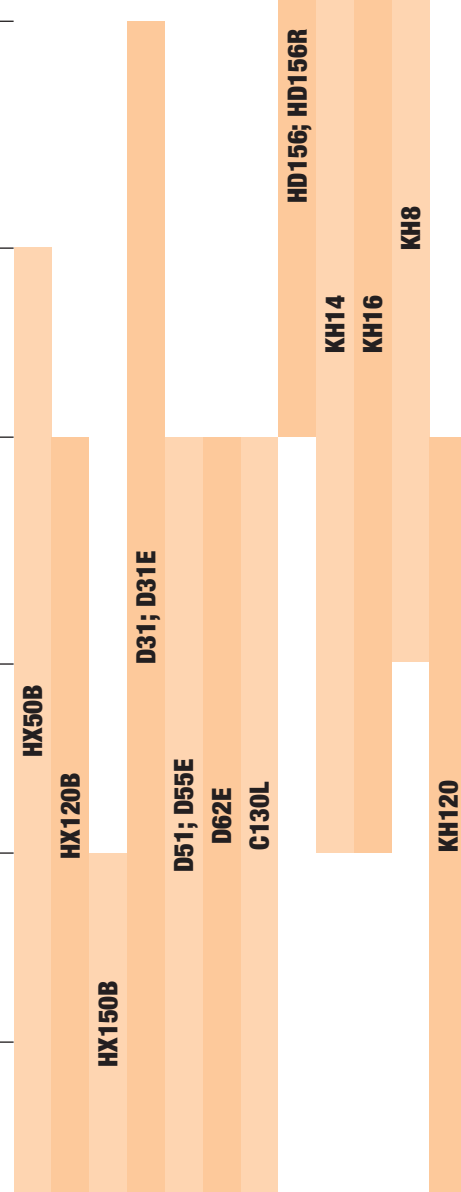

TÜV MEEI TEST DOCUMENTATION
V-07008

RELEVANT STANDARD
MSZ-05-45.1601-1

RELEVANT STANDARD
EN 61238-1

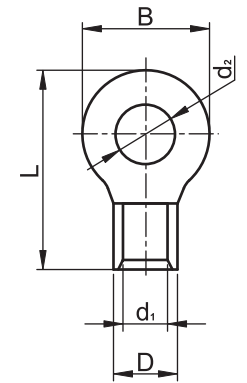

Papuci inelari neizolați

TRACON	d ₁ (mm)	d ₂ (mm)	D (mm)	L (mm)	B (mm)	mm ²			mm ²	
						70-95	50-70	35-50	95-120	70-95
SZ50-6	11.4	6.4	15.5	50	22					
SZ50-8	11.4	8.4	15.5	50	22					
SZ50-10	11.4	10.5	15.5	50	22	70-95	50-70	35-50		
SZ50-12	11.4	13	15.5	47.2	22					
SZ50-16	11.4	17	15.5	57.4	32					
SZ70-6	13.3	6.4	17.5	51	24					
SZ70-8	13.3	8.4	17.5	51	24					
SZ70-10	13.3	10.5	17.5	51	24	95-120	70-95	50-70		
SZ70-12	13.3	13	17.5	51	24					
SZ70-16	13.3	17	17.5	60.7	31.8					
SZ95-8	14.5	8.4	19.5	54	27					
SZ95-10	14.5	10.5	19.5	54	27	120-150	95-120	50-70		
SZ95-12	14.5	13	20.5	54	23.8					
SZ95-16	14.5	17	20.5	58	27.8					
SZ120-8	16.4	8.4	22.5	56	28.4					
SZ120-10	16.4	10.5	22.5	56	28.4		120-150	70-95		
SZ120-12	16.4	13	22.5	55.6	28.4	-				
SZ120-16	16.4	17	22.5	69	32					
SZ150-10	19.5	10.5	26.5	65.8	36					
SZ150-12	19.5	13	26.5	65.8	36					
SZ150-16	19.5	17	26.5	65.8	36	-	185	150		
SZ150-20	19.5	21	26.5	80.5	36					
SZ150-24	19.5	25	26.5	80.5	36					
SZ185-10	21	10.5	28.5	68.8	38.4					
SZ185-12	21	13	28.5	68.8	38.4					
SZ185-16	21	17	28.5	68.8	35.8	-	240	150-185		
SZ185-20	21	21	28.5	87	38.8					
SZ185-24	21	25	28.5	87	38.8					
SZ240-10	24	10.5	32.5	71.5	44					
SZ240-12	24	13	32.5	71.5	44					
SZ240-16	24	17	32.5	71.5	44	-	300	185-240		
SZ240-20	24	21	32.5	90.6	44					
SZ240-24	24	25	32.5	90.6	44					

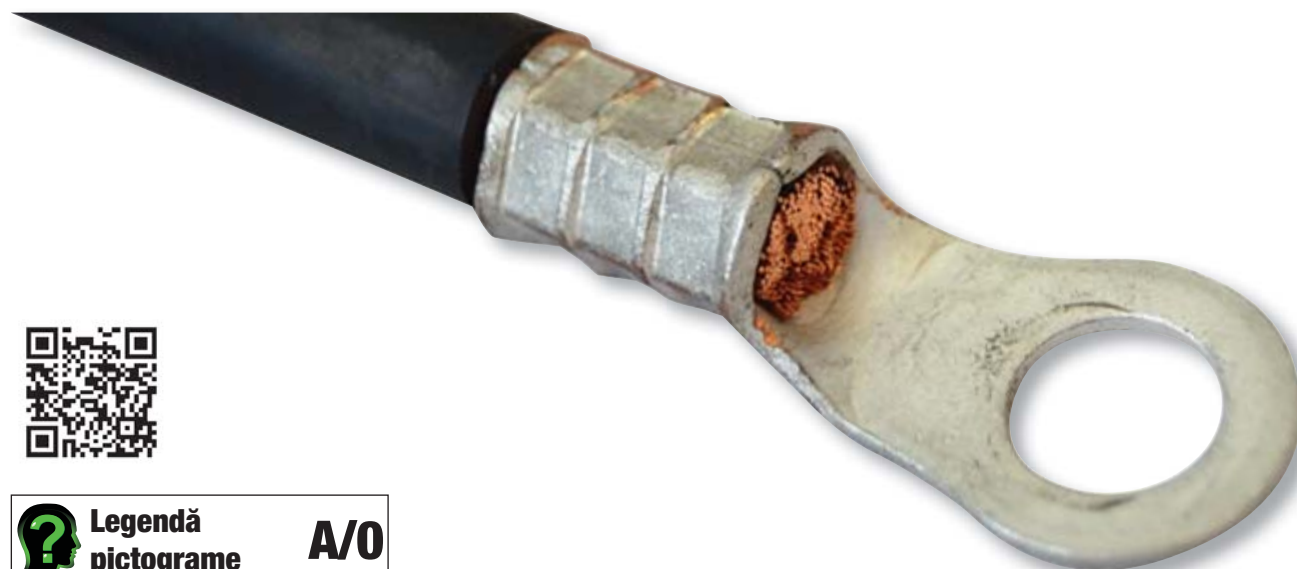

Legendă
pictograme

A/O

Papuci inelari neizolați din țevă

TRACON	d ₁ (mm)	d ₂ (mm)	D (mm)	L (mm)	B (mm)	mm ²											
CL1.5-3	1.9	3.7	3.4	17	8												
CL1.5-4	1.9	4.3	3.4	17	8	1.5-2.5	1.5	1-1.5									
CL1.5-5	1.9	5.5	3.4	17	8.5												
CL2.5-4	2.4	4.3	3.9	18	8												
CL2.5-5	2.4	5.3	3.9	18	8	2.5-4	2.5	1.5									
CL2.5-6	2.4	6.4	3.9	19	10												
CL4-5	2.8	5.3	4.5	20.5	10												
CL4-6	2.8	6.4	4.5	20.5	10	4-6	4	2.5									
CL6-5	3.8	5.3	5.5	23	10												
CL6-6	3.8	6.4	5.5	23.5	10	10	6	4									
CL6-8	3.8	8.4	5.5	24.5	12.4												
CL10-6	4.4	6.5	6.1	24.5	10.2												
CL10-8	4.4	8.6	6.1	25.5	12.6	10-16	10	6									
CL16-6	5.4	6.4	7.1	30	10.2												
CL16-8	5.4	8.4	7.1	30	12.7	16	16	10									
CL25-6	6.8	6.4	8.8	30	12.6												
CL25-8	6.8	8.4	8.6	30	12.4	25-35	25	16									
CL25-10	6.8	10.5	8.8	31	15												
CL35-6	8.2	6.4	10.5	35	15.3												
CL35-8	8.2	8.4	10.5	35	15.3												
CL35-10	8.2	10.5	10.5	35	15.3	50	35	25									
CL35-12	8.2	13	10.5	36.5	18.6												
CL50-8	9.5	8.4	12.5	43	18												
CL50-10	9.5	10.5	12.5	43	18	70	50	35									
CL50-12	9.5	13	12.5	43	19												
CL70-8	11.2	8.4	16.5	50	23												
CL70-10	11.2	10.5	14.5	50	21	95	70	50									
CL70-12	11.2	13	14.5	50	21												
CL95-10	13.5	10.5	17.2	55	25												
CL95-12	13.5	13	17.2	55	25.5	120	95	70									
CL120-10	14.5	10.5	19.2	60	28												
CL120-12	14.5	13	19.2	60	28	150	120	70-95									
CL120-16	14.5	17	19.2	60	28												

Legendă pictograme A/O

E-Cu-sn





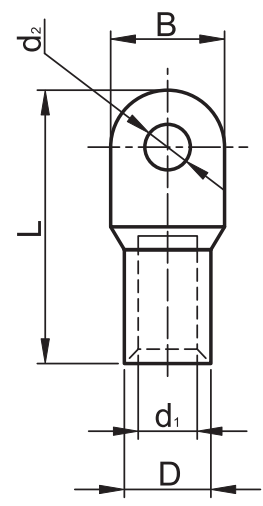

EVPŪ CERTIFICATE NO.
02337/101/1/2001

RELEVANT STANDARD
MSZ-05-45.1601-1

RELEVANT STANDARD
EN 61238-1







Papuci inelari neizolați din țevă

TRACON	d ₁ (mm)	d ₂ (mm)	D (mm)	L (mm)	B (mm)	mm ²			
									
CL150-12	16.5	13	20.8	69	30.5	-	-	-	HX150B
CL150-14	16.5	15	20.8	72	30.5	-	150	95	
CL150-16	16.5	17	20.8	75	31	-	-	-	
CL185-12	18	13	23.2	78	35	-	-	-	D51; D55E D62E C130L
CL185-14	18.5	15	23.2	78	35	-	185	120-150	
CL185-16	18	17	23.2	78	35	-	-	-	
CL240-14	21	15	26	90	38.3	-	-	-	D51; D55E D62E C130L
CL240-16	20.3	17	26	90	38.3	-	240	150-185	
CL300-16	23.5	17	30	100	43.5	-	300	185-240	
CL400-16	28.5	17	36.5	115	53	-	400	300	D51; D55E D62E C130L
CL400-20	28.5	21	36.5	115	53	-	400	300	
CL500-16	29.5	17	39	125	56	-	500	300	
CL625-16	34.5	17	44	130	62	-	625	400	



Papuci inelari prelungiți, din țevă de CU

TRACON	d ₁ (mm)	d ₂ (mm)	D (mm)	L (mm)	I (mm)	B (mm)	mm ²			
										
SZ-CL16	6	8.5	10	68.5	31	16	25	16	10	HX50B
SZ-CL25	7.3	8.5	11.2	73.5	34	18	35	25	16	
SZ-CL35	8.5	8.5	12.2	78.5	34	20.5	50	35	25	
SZ-CL50	10	10.5	14.2	86.5	39.5	23	70	50	35	HX120B HX150B
SZ-CL70	11.5	12.5	16	100	42	26	95	70	50	
SZ-CL95	13.6	12.5	18.2	104	44.5	28	120	95	70	
SZ-CL120	15	14.7	20	112.5	51	30	150	120	70-95	D31; D31E D51; D55E D62E; C130L KH120
SZ-CL150	17	14.7	22	118.5	56	34	-	150	120	
SZ-CL185	19	16.5	25	127.5	62	37	-	185	120-150	
SZ-CL240	21	16.5	27	137	65	39.5	-	240	150-185	

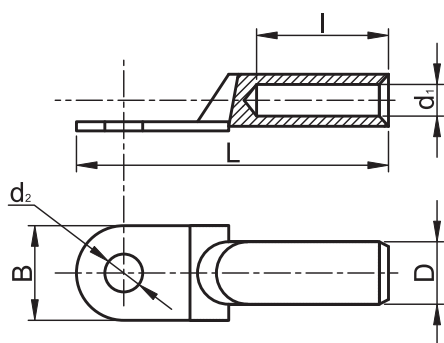

RELEVANT STANDARD
MSZ-05-45.1601-1

RELEVANT STANDARD
EN 61238-1







CITIȚI CODUL !

- Vezi noutățile noastre
- Fiți informat

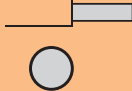
Gama de produse se dezvoltă continuu și rapid!
Catalogul nostru reflectă situația din Octombrie 2017.
Pentru informații actualizate vizitați pagina
noastră de internet!

Papuci inelari neizolați din Al

TRACON	d ₁ (mm)	d ₂ (mm)	D (mm)	L (mm)	I (mm)	B (mm)	mm ²			
										
AS16-6	5.5	6.4	8.5	65	32	13	25	16		
AS16-8	5.5	8.4	8.5	69	32	13	25	16		
AS25-6	7	6.4	10	68	32	14	35	25		
AS25-8	7	8.4	10	72	32	16	35	25		
AS25-10	7	10.5	10	74	32	17	35	25		
AS35-6	8.2	6.4	12.5	59	32	15	50	35		
AS35-8	8.2	8.4	12.5	77	32	17	50	35		
AS35-10	8.2	10.5	12.5	80	32	19	50	35		
AS35-12	8.2	13	12.5	81	32	21	50	35		
AS50-8	10	8.4	14.5	91	45	20	70	50		
AS50-10	10	10.5	14.5	94	45	22	70	50		
AS50-12	10	13	14.5	95	45	24	70	50		
AS70-8	11.5	8.4	16.5	95	45	24	95	70		
AS70-10	11.5	10.5	16.5	98	45	24	95	70		
AS70-12	11.5	13	16.5	100	45	24	95	70		
AS95-10	13.5	10.5	19	112	56	28	120	95/120		
AS95-12	13.5	13	19	113	56	28	120	95/120		
AS120-10	15.5	10.5	21	119	56	32	150	120/150		
AS120-12	15.5	13	21	121	56	32	150	120/150		
AS120-14	15.5	15	21	98	56	32	150	120/150		
AS120-16	15.5	17	21	125	56	32	150	120/150		
AS150-10	17	10.5	23.5	130	56	34	185	150		
AS150-12	17	13	23.5	132	56	34	185	150		
AS150-14	17	15	23.5	109	56	34	185	150		
AS150-16	17	17	23.5	136	56	34	185	150		
AS185-10	19	10.5	25.5	136	64	37	240	185		
AS185-12	19	13	25.5	137	64	37	240	185		
AS185-14	19	15	25.5	115	64	37	240	185		
AS185-16	19	17	25.5	142	64	37	240	185		
AS240-12	21.5	13	29	151	64	42	300	240		
AS240-14	21.5	15	29	130	64	42	300	240		
AS240-16	21.5	17	29	156	64	42	300	240		

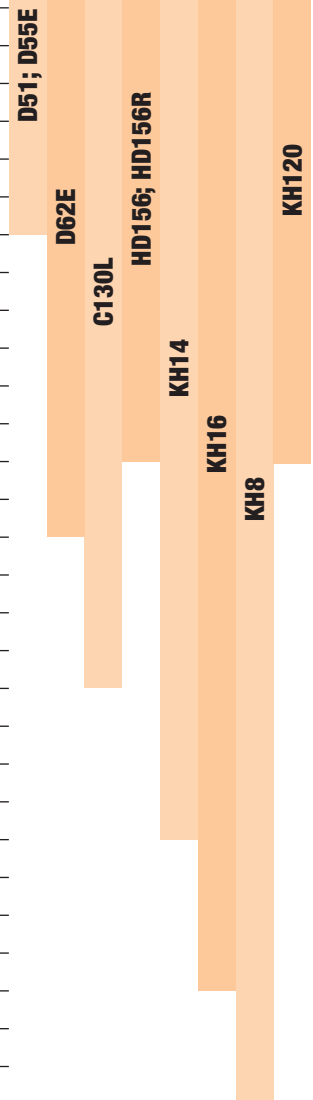

TÜV MEEI TEST DOCUMENTATION
V-09444

RELEVANT STANDARD
EN 61238-1



RELEVANT STANDARD
MSZ-05-45.1601-1

RELEVANT STANDARD
MSZ-05-45.1601-22

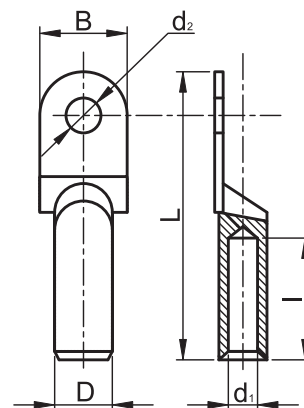
 Legendă pictograme **A/0**

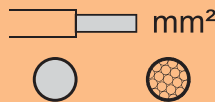

Papuci inelari neizolați Cu-Al

TRACON	d ₁ (mm)	d ₂ (mm)	D (mm)	L (mm)	I (mm)	B (mm)	 mm ²	
RA16-6	5.8	6.5	10.3	69	32	16	16-25	16
RA16-8	5.8	8.5	10.3	69	32	16	16-25	16
RA25-8	7.5	8.5	12	76	32	18	35	25
RA35-8	8.5	8.8	14.3	85	37.5	20	50	35-50
RA50-10	9.5	10.5	16	91	41	23	70	50
RA70-12	11.5	12.5	18	101	43.5	26	95	70
RA95-12	13.5	12.5	20	107	46.5	28	120	95-120
RA120-14	15.5	14.5	23	118	53	30	150	120-150
RA150-14	16.5	14.5	24	125	55	34	185	150
RA185-16	18.5	17	27	133	60	37	240	185
RA240-16	21	16.5	30	139	60	40	300	240

HX50B

HX120B

HX150B

D31; D31E

D51; D55E

D62E

C130L

KH120

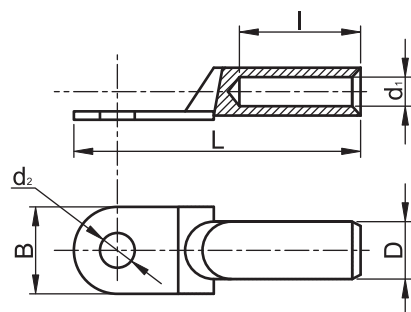

RELEVANT STANDARD
EN 61238-1

RELEVANT STANDARD
MSZ-05-45.1601-1

RELEVANT STANDARD
MSZ-05-45.1601-22

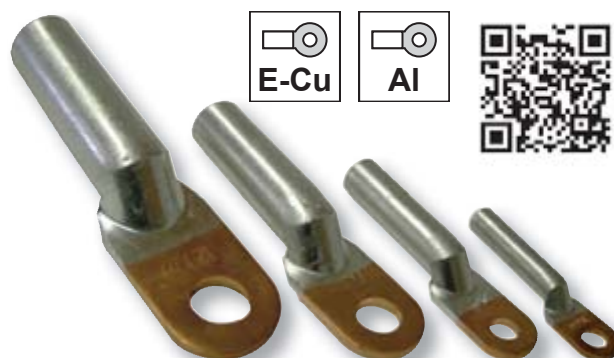



E-Cu

Al



Papuci cu prindere prin șurub



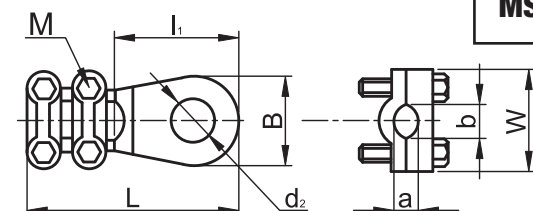

TRACON	a (mm)	b (mm)	d ₂ (mm)	L (mm)	I ₁ (mm)	B (mm)	W (mm)	X 	 mm ²
WCJB-16-25-2	4	6	8.5	45.3	22	18	22.5	4 × M5 × 20	16-25
WCJB-25-35	4	7	10.5	52.5	25	21.5	24.5	4 × M5 × 22	25-35
WCJB-50-70	5	10	10.5	61	26	23	31	4 × M6 × 24	50-70
WCJB-70-95	5.5	11.5	10.5	69	32	23.5	35	4 × M6 × 30	70-95
WCJB-95-120	5.5	13	13.5	74	28.5	28.5	42	4 × M8 × 35	95-120
WCJB-120-150	5.5	13	13.5	74	30	27	41	4 × M8 × 35	120-150
WCJB-150-185	6.5	13	13.5	76.5	31	28	42.5	4 × M8 × 35	150-180
WCJB-185-240	6.5	14	13.5	80.3	32.5	30	44	4 × M8 × 35	185-240
WCJC-16	3	4.5	8	37	22.5	16	21.5	2 × M5 × 20	16
WCJC-25-35	5	8.5	11	47.5	27.5	22	22	2 × M5 × 23	25-35
WCJC-50-70	6	9.5	11	60.5	31	23	30	4 × M6 × 24	50-70
WCJC-70-95	7	12	13	66.5	35	27	33	4 × M6 × 29	70-95
WCJC-120-150	7	12.5	15	72.5	42	32	32	4 × M6 × 29	120-150
WCJC-185-240	14	19	18	90	46	39	45	4 × M8 × 40	185-240
WCJC-300	14.5	23	21	106	54	45.5	55.5	4 × M10 × 48	300
WCJC-400	19.5	25.5	22.3	122	63	50	59.5	4 × M10 × 52	400

RELEVANT STANDARD
MSZ-05-45.1601-12

E-Cu-sn



Papuci tip furcă neizolați





TRACON	d ₁ (mm)	d ₂ (mm)	D (mm)	L (mm)	I (mm)	B (mm)	mm ²			
										
V1.5-3	1.7	3.7	3.4	15.5	6.5	5.7				HD156; HD156R
V1.5-4	1.7	4.3	3.4	15.5	6.7	7.2	1.5	1-1.5	0.5-1	
V1.5-5	1.7	5.3	3.4	15.5	7.8	6.4				
V1.5-6	1.7	6.4	3.4	15.5	8.9	8.1				
V2.5-3	2.3	3.7	4.1	16	6.9	6				
V2.5-4	2.3	4.3	4.1	16	7.3	7.2	2.5-4	2.5	1.5	
V2.5-5	2.3	5.3	4.1	16	7.7	8.1				HX50B; HX120B; D31; D31E
V2.5-6	2.3	6.4	4.1	16	8.8	9.5				
V4-3	3.4	3.7	5.6	19.5	6.7	8.3				
V4-4	3.4	4.3	5.6	19.5	7	8.3	4	4-6	6	
V4-5	3.4	5.3	5.6	19.5	7.5	9				
V4-6	3.4	6.4	5.6	19.5	10.3	12				
V10-4	4.5	4.3	7.2	23	8.3	8.7				KH8; KH14; KH16
V10-5	4.5	5.3	7.2	24.5	8.7	12	10-16	10	6	
V10-6	4.5	6.4	7.2	24.5	9.4	12				
V16-5	5.8	5.3	9	28	9.7	12				
V16-6	5.8	6.4	9	28	9.8	14	25	16	10	

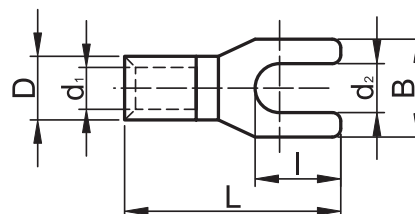

RELEVANT STANDARD
MSZ-05-45.1601-1
MSZ-05-45.1601-22



Papuci tip pin neizolați

TRACON	d ₁ (mm)	D (mm)	L (mm)	I (mm)	B (mm)	mm ²			
									
CS1.5	1.7	3.2	16.7	11.5	1.7	1.5-2.5	1.5	1-1.5	HD156; HD156R; KH8; KH14; KH16
CS2.5	2.3	3.8	16.7	11.5	2	2.5-4	2.5	1.5	
CS4	3.4	5.5	20	12.5	2.6	6	4-6	4	

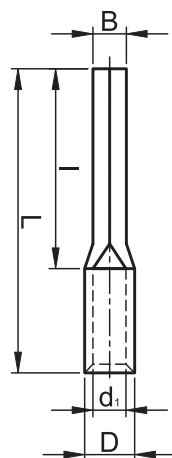

EVPÚ CERTIFICATE NO.
02337/101/1/2001



CITIȚI CODUL !

- Vezi noutățile noastre
- Fiți informat

Gama de produse se dezvoltă continuu și rapid!
 Catalogul nostru reflectă situația din Octombrie 2017.
 Pentru informații actualizate vizitați pagina
 noastră de internet!

Mufe neizolate

TRACON	d ₁ (mm)	D (mm)	L (mm)	mm ²			mm	
				●	●	●	○	○
TH1.5	1.9	3.5	12	1.5-2.5	1.5-2.5	1-1.5		
TH2.5	2.4	3.9	13	4	4	1.5		
TH4	2.8	4.5	15	4-6	4-6	2.5		
TH6	3.8	5.5	15	6-10	6-10	4		
TH10	4.5	6.1	15	10-16	10-16	6		
TH16	5.4	7.1	21	16-25	16-25	10		
TH25	6.8	8.7	26	25-35	25-35	16		
TH35	8.2	10.5	29	50	50	25		
TH50	9.5	12.4	32	70	70	35		
TH70	11.2	14.7	36	95	95	50		
TH95	13.5	17.4	37	120	120	70		
TH120	15	19.4	38	150	150	70/95		
TH150	16.5	21.2	38	-	-	95		
TH185	18.5	23.5	54	-	-	120		
TH240	21	26.5	72	-	-	150-185		

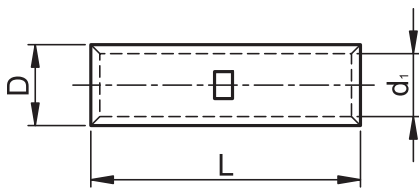
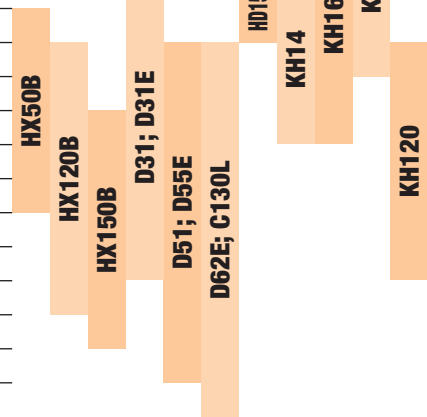

RELEVANT STANDARD
MSZ-05-45.1601-1
EN 61238-1

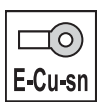

Mufe neizolate Cu-Al



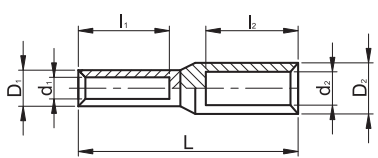
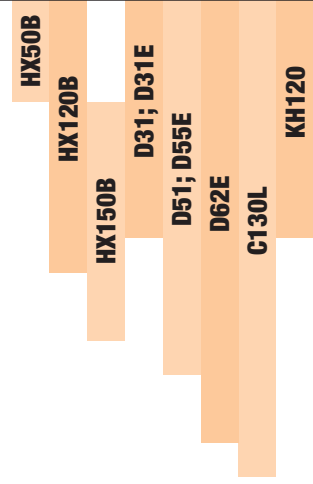



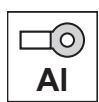



TRACON	d ₁ /d ₂ (mm)	D ₁ /D ₂ (mm)	L (mm)	l ₁ /l ₂ (mm)	mm ²					mm	
					●	●	●	●	●	○	○
RT16/25	6/6.7	10/12.1	75	26.5/32	16	10	6	25	16		
RT16/70	5.5/11	12/17.5	90.5	29.5/45	16	10	6	70	50		
RT25/35	7.3/8	11.6/13.1	83.5	30/40	25	16	10	35	25		
RT35/50	8.5/10	13.3/15.3	95.6	32/42	35	25	16	50	35-50		
RT35/70	8.5/11	12/17.5	90	30/45	35	25	16	70	50		
RT50/70	9.5/11.5	14.6/18	104.5	38/50	50	35	25	70	50		
RT70/95	11.5/13.5	17/21.5	111	40/50	70	50	35	95	70		
RT95/120	12.6/15	19/23.2	110	42/55	95	70	50	120	95-120		
RT95/150	13.5/16.5	19/24.8	116	42/55	95	70	50	150	120-150		
RT120/150	15/17	19/24	118	44/55	120	95	70	150	120-150		
RT150/185	16.6/18	22.5/25.2	125	46/60	-	120	95	185	150-185		
RT185/240	18.5/21	26/30	130	54/60	-	150	120	240	185		
RT185/300	18.5/23	26/34	136	54/65	-	150	120	300	240		
RT240/300	21/23	28/34	145	56/65	-	185	120-150	300	240		



RELEVANT STANDARD
EN 61238-1
MSZ-05-45.1601-1
MSZ-05-45.1601-21



Mufe neizolate din Al

TRACON	d _i (mm)	D (mm)	L (mm)	I (mm)	mm ²		
							
AT16	5.2	9.4	69	30.5	25	16	       
AT25	6.4	11.4	71	31.5	35	25	
AT35	7.2	12.2	81	36	50	35	
AT50	9	15.1	92	45	70	50	
AT70	11.2	17.8	101	46	95	70	
AT95	13.2	20.3	108	49.5	120	95-120	
AT120	14.2	22.6	111.3	52.5	150	120-150	
AT150	16.4	25	116	55	185	150	
AT185	18.5	27.6	125	60.5	240	185	
AT240	20	30.2	126	60	300	240	

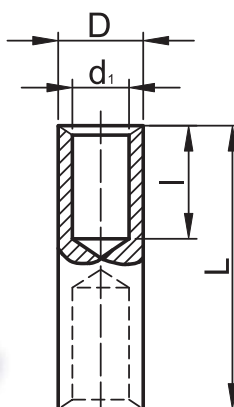

RELEVANT STANDARD
EN 61238-1
MSZ-05-45.1601-1
MSZ-05-45.1601-21





TRACON APPLICATION



ANDROID APP ON
Google play



Available on the
App Store









CITIȚI CODUL !

- Vezi noutățile noastre
- Fiți informat

Gama de produse se dezvoltă continuu și rapid!
Catalogul nostru reflectă situația din Octombrie 2017.
Pentru informații actualizate vizitați pagina noastră de internet!

Mufe de AL cu șurub având limitator de strângere (ruperea capului)

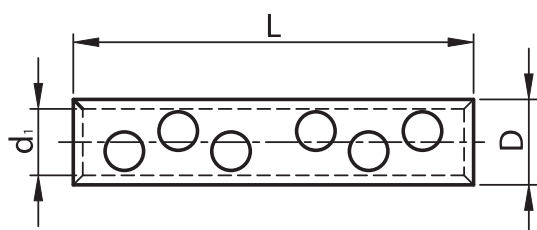

TRACON	 mm ²	d ₁ (mm)	D (mm)	L (mm)	X 
AT16-70CS	B: 16 - 35	11	21.7	107	(2+2) × M12
	A: 50 - 70				(2+2) × M12
AT95-150CS	B: 95 - 120	16	27	133	(2+2) × M12
	A: 150				(2+2) × M12
AT185-240CS	B: 185	20	34	145	(3+3) × M16
	A: 240				(3+3) × M16

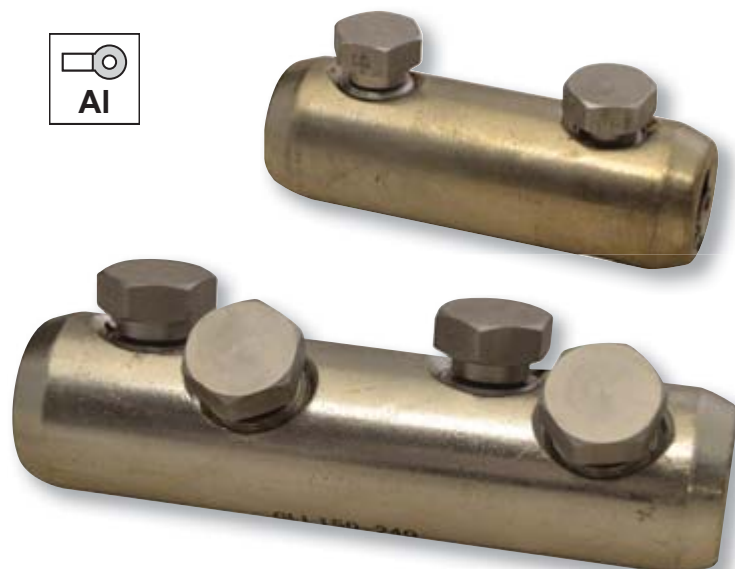

RELEVANT STANDARD
MSZ-05-45.1601-1

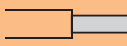

Papuci inelari de AL cu șurub având limitator de strângere (ruperea capului)

TRACON	 mm ²	d ₁ (mm)	d ₂ (mm)	D (mm)	L (mm)	B (mm)	X 
AS16-70CS12	B: 16 - 35	11	13	23	90	25	2 × M12
	A: 50 - 70						2 × M12
AS185-240CS16	B: 185	20	17	35	115	38	3 × M16
	A: 240						3 × M16

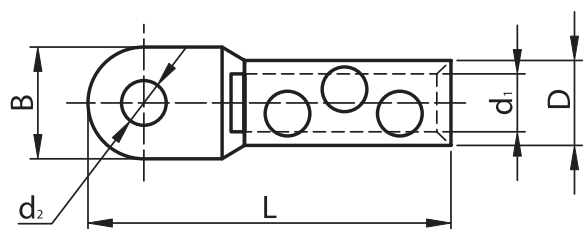

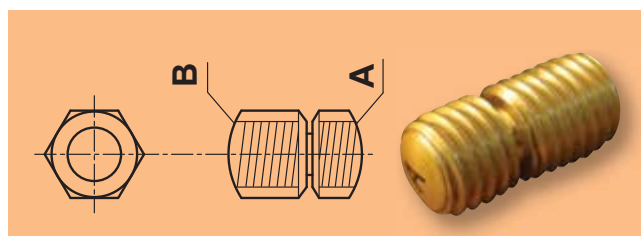

 **Legendă pictograme** **A/O**

RELEVANT STANDARD
MSZ-05-45.1601-1

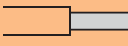

Papuci inelari CU-AL cu șurub având limitator de strângere (ruperea capului)

TRACON	 mm ²	d ₁ (mm)	d ₂ (mm)	D (mm)	L (mm)	B (mm)	X 
RA16-70CS12	B: 16 - 35	11	13	23	104	25	2 × M12
	A: 50 - 70						2 × M12
RA95-150CS12	B: 95 - 120	16	12	30	110	30	2 × M12
	A: 150						2 × M12
RA185-240CS16	B: 185	20	17	35	115	38	3 × M16
	A: 240						3 × M16

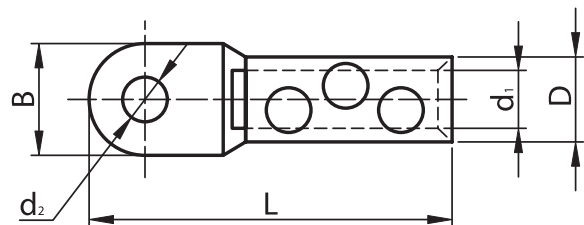
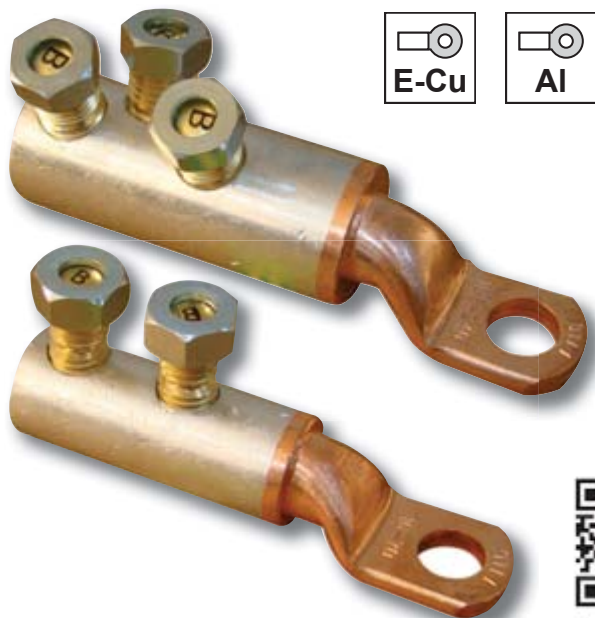

RELEVANT STANDARD
MSZ-05-45.1601-1

 **Legendă pictograme** **A/O**

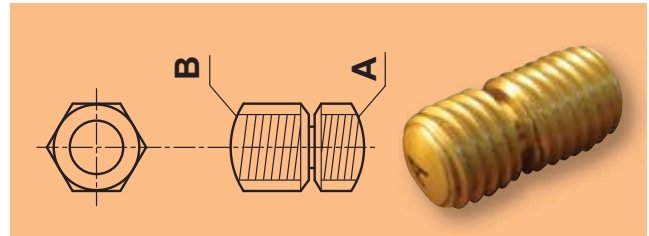

Izolații pentru papuci neizolați

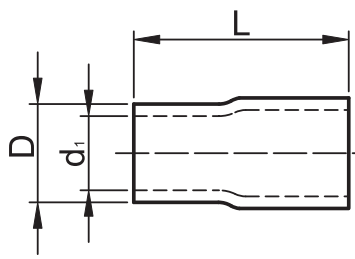

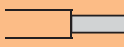
TRACON	d ₁ (mm)	D (mm)	L (mm)	 mm ²
FSZIG10	6	9.4	21.5	10
FSZIG16	8.1	11.4	28.3	16
FSZIG25	9.8	13.1	30.1	25
FSZIG35	11	14.4	34.7	35
FSZIG50	13.8	17.2	43.7	50
FSZIG95	15.8	19.3	47.5	95
FSZIG120	17.6	21.2	56.6	120

 **PVC**  **T_a**
-20...+75 °C



RELEVANT STANDARD
IEC 60684-1



Pastă de protecție și contact



TRACON 
VKP 150 g

Amestecul pentru îmbunătățirea conductivității electrice a legăturilor dezvoltat pentru împiedicarea oxidării suprafețelor de contact și a coroziunii. Amestecul pentru îmbunătățirea conductivității se folosește în toate condițiile (legături Al – Al, Al – Cu și Cu – Cu) la suprafața de contact, înainte de presare, strângere cu șurub sau nituire.

Cleme de legătură cu șurub pentru realizarea derivațiilor

TRACON	 mm ²	H (mm)	C (mm)	B (a/f) (mm ²)	D (a/f) (mm)	F (mm)	 M
YCSK-6	1.5 - 6	24	3.2	10	12,7	6.5	M12
YCSK-10	2.5 - 10	27.3	5.5	12.7	19	5.6	M12
YCSK-16	4 - 16	27.3	5.5	12.7	19	5.6	M12
YCSK-25	6 - 25	28.9	6.9	15	19	5.6	M14

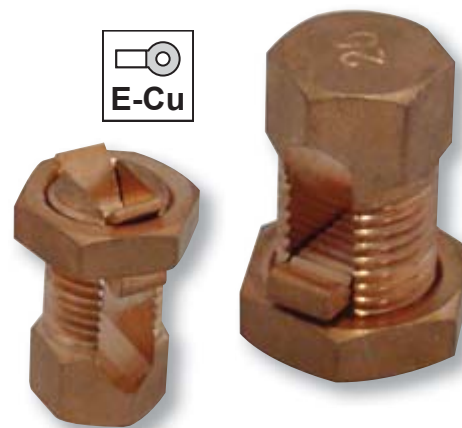
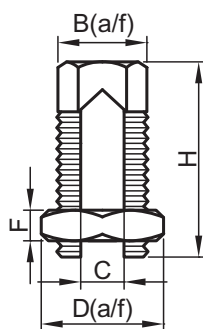

Conectori panou fotovoltaic

600/1000 V AC/DC	 U_i 1 kV	I_n max. 20 A	 R ≥ 0.5mΩ	V5/V0 UL94	 PC/PA6.6	T_a -40..+85°C	 [mm ²] 1×4	 UV ☺	 MC4
----------------------------	---	--------------------------------------	--	----------------------	---	------------------------------------	--	--	--



TRACON	IP..
SOLAR11-4AB	IP 68
SOLAR11-4N	IP 67
SOLAR1-2AB	IP 67

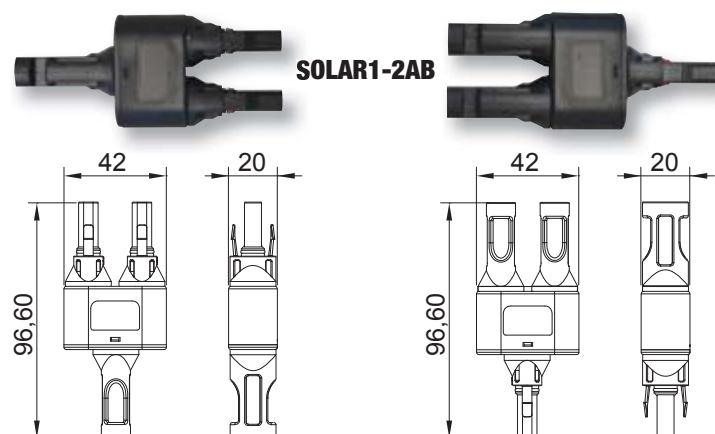

RELEVANT STANDARD
EN 50521

RELEVANT STANDARD
IEC 61646

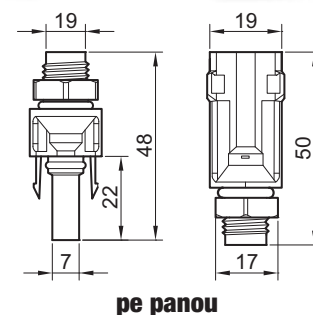

pe panou

În general panourile fotovoltaice sunt ușor de conectat datorită capetelor de cablu prevăzute anterior. De la panoul fotovoltaic astfel conectat trebuie realizată o cablare de curent continuu până la inverter sau tabloul de conexiuni situat înaintea inverterului. Luând în considerare varianta constructivă este cu presetupă (etanșare totală IP68) și contrapiuliță. Se poate sertiza cu presa. Se comercializează doar perechi.



Presă pentru conectori panou fotovoltaic

SOLAR11-PT

B/3

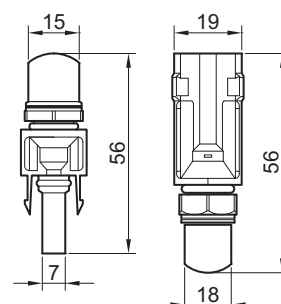





pe cablu

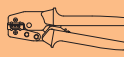

SOLAR11-4AB

Papuci inelari izolați

TRACON	d ₁ (mm)	d ₂ (mm)	D (mm)	L (mm)	B (mm)	mm ²			
									
■ PSZ3	1.7	3.7	5.4	18	5.6	1.5	1-1.5	0.75-1	
■ PSZ4	1.7	4.3	5.4	22.3	8	1.5	1-1.5	0.75-1	
■ PSZ5	1.7	5.3	5.4	22.3	8	1.5	1-1.5	0.75-1	
■ PSZ6	1.7	6.4	5.4	27.7	11.5	1.5	1-1.5	0.75-1	
■ PSZ8	1.7	8.4	5.4	27.7	11.5	1.5	1-1.5	0.75-1	
■ PSZ10	1.7	10.5	5.4	31.8	13.6	1.5	1-1.5	0.75-1	
■ KSZ3	2.3	3.7	6.1	22.8	8.4	2.5-4	1.5-2.5	1.5-2.5	
■ KSZ4	2.3	4.4	6.1	22.8	8.4	2.5-4	1.5-2.5	1.5-2.5	
■ KSZ5	2.3	5.3	6.1	23.4	9.4	2.5-4	1.5-2.5	1.5-2.5	
■ KSZ6	2.3	6.4	6.1	28.7	11.7	2.5-4	1.5-2.5	1.5-2.5	
■ KSZ8	2.3	8.4	6.1	28.7	11.7	2.5-4	1.5-2.5	1.5-2.5	
■ KSZ10	2.3	10.5	6.1	32	13.6	2.5-4	1.5-2.5	1.5-2.5	
■ KSZ12	2.3	13	6.1	35	13.6	2.5-4	1.5-2.5	1.5-2.5	
■ SSZ3	3.4	3.7	8	22.1	7.3	6	4-6	4	
■ SSZ4	3.4	4.4	8	28.2	9.4	6	4-6	4	
■ SSZ5	3.4	5.3	8	27.5	9.4	6	4-6	4	
■ SSZ6	3.4	6.4	8	31.5	11.9	6	4-6	4	
■ SSZ8	3.4	8.4	8	36.4	14.9	6	4-6	4	
■ SSZ10	3.4	10.5	8	36.4	14.9	6	4-6	4	
■ SSZ12	3.4	13	8	40	18.9	6	4-6	4	
■ PSZ10-5	4.5	5.3	10	34.1	12.1	10-16	10	6	
■ PSZ10-6	4.5	6.4	10	34.1	12.1	10-16	10	6	
■ PSZ10-8	4.5	8.4	10	40.4	14.8	10-16	10	6	
■ PSZ10-10	4.5	10.5	10.5	38.5	14.8	10-16	10	6	
■ PSZ10-12	4.5	13	10.5	43.4	18.9	10-16	10	6	
■ KSZ16-5	5.7	5.3	12.5	38	11.9	25	16	10	
■ KSZ16-6	5.7	6.4	12.5	37.6	11.9	25	16	10	
■ KSZ16-8	5.7	8.4	12.5	41.6	15.9	25	16	10	
■ KSZ16-10	5.7	10.5	12.5	41.7	15.9	25	16	10	
■ KSZ16-12	5.7	13	12.5	50	22	25	16	10	
■ SSZ25-5	7.7	5.3	15	44.5	16.5	35-50	25-35	16-25	
■ SSZ25-6	7.7	6.4	15	44.5	16.5	35-50	25-35	16-25	
■ SSZ25-8	7.7	8.4	15	44.5	16.5	35-50	25-35	16-25	
■ SSZ25-10	7.7	10.5	15	47.4	17.4	35-50	25-35	16-25	
■ SSZ25-12	7.7	13	15	53.5	22	35-50	25-35	16-25	
■ PSZ35-6	9.4	6.4	18	53.5	22	70	50	35	
■ PSZ35-8	9.4	8.4	18	53.5	22	70	50	35	
■ PSZ35-10	9.4	10.5	18	53.8	22	70	50	35	
■ PSZ35-12	9.4	13	18	53.8	22	70	50	35	

9006; 9006R;
9006RS

LY35C

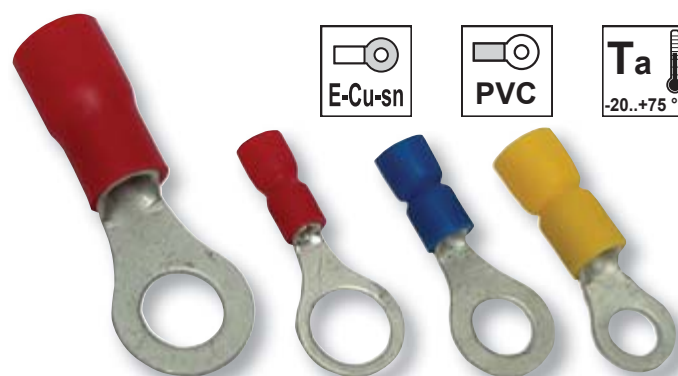

RELEVANT STANDARD
MSZ-05-45.1601-1
EN 61238-1

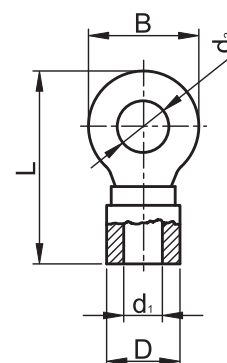

Papuci tip furcă izolați

TRACON	d ₁ (mm)	d ₂ (mm)	D (mm)	L (mm)	I (mm)	B (mm)	mm ²			
PV3	1.7	3.7	5.4	21.5	6.4	6.3	1.5	1.5	0.75-1	9006; 9006R; 9006RS
PV4	1.7	4.3	5.4	21.5	6.6	7.1	1.5	1.5	0.75-1	
PV5	1.7	5.3	5.4	22.5	7.6	7.9	1.5	1.5	0.75-1	
PV6	1.7	6.6	5.4	25.5	8.7	10.8	1.5	1.5	0.75-1	
KV3	2.3	3.6	6.1	22.7	6.6	6.2	2.5-4	1.5-2.5	1.5-2.5	
KV4	2.3	4.3	6.1	22.7	7.1	7.1	2.5-4	1.5-2.5	1.5-2.5	
KV5	2.3	5.3	6.1	23	7.6	7.9	2.5-4	1.5-2.5	1.5-2.5	
KV6	2.3	6.6	6.1	26.5	8.7	10.7	2.5-4	1.5-2.5	1.5-2.5	
SV3	3.4	3.6	8	26.5	7.3	7.2	6	4-6	4	
SV4	3.4	4.3	8	27.3	7	8.1	6	4-6	4	
SV5	3.4	5.3	8	27.3	7.4	9	6	4-6	4	
SV6	3.4	6.4	8	30.3	9.2	10.8	6	4-6	4	

RELEVANT STANDARD
MSZ-05-45.1601-22
MSZ-05-45.1601-1

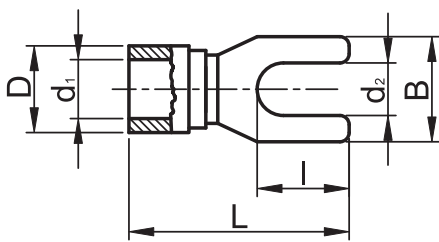





Scule recomandate de presat:

TRACON	mm ²
LY35C	10-35
9006RS	0,5-2,5
9006R	2,5-6
9006	2,5-6



B/6



Fișe cilindrice izolate

TRACON	d ₁ (mm)	d ₂ (mm)	D (mm)	L (mm)	I (mm)	mm ²			
									
■ PH4	1.7	4	4.7	22.6	9	1-2.5	1-1.5	0.75-1	9006; 9006R; 9006RS
■ KH4	2.2	5	5.5	22	9	2.5	1.5-2.5	1.5	
■ SH4	3.6	5	7.5	24.3	9	6	4-6	4	





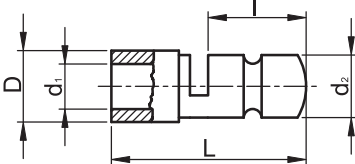











**RELEVANT STANDARD
EN 61238-1**

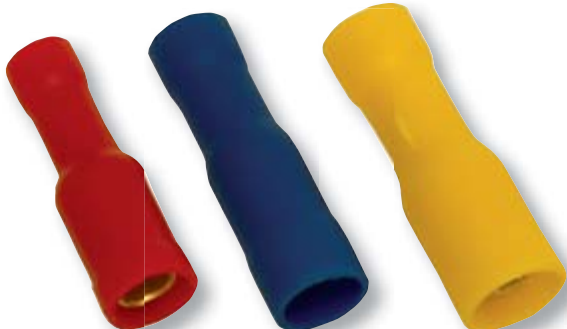

Mufe cilindrice izolate

TRACON	d ₁ (mm)	d ₂ (mm)	D (mm)	L (mm)	I (mm)	mm ²			
									
■ PHA4	1.8	4	5.5	23.8	-	1-2.5	1-1.5	0.5-1.5	9006; 9006R; 9006RS
■ KHA4	2.1	5	6	23	-	2.5	1.5-2.5	1.5	
■ SHA4	3.5	5	7.4	25	-	6	4-6	4	





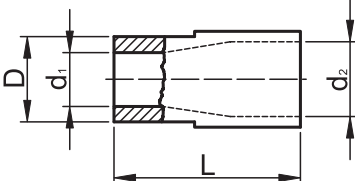











**RELEVANT STANDARD
EN 61238-1**



Papuci tip pin izolați

TRACON	d ₁ (mm)	D (mm)	L (mm)	I ₁ (mm)	B (mm)	mm ²			
									
■ PCS	1.8	5.4	23.3	12	1.9	1-2.5	1-1.5	0.5-1.5	9006; 9006R; 9006RS
■ KCS	2.3	6	23.3	12	1.9	2.5-4	1.5-2.5	1.5-2.5	
■ SCS	3.5	7.8	28.5	13	2.7	6	4-6	4	



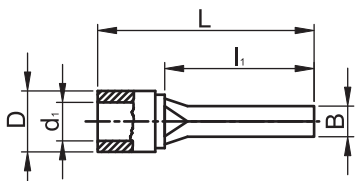

**RELEVANT STANDARD
MSZ-05-45.1601-1
MSZ-05-45.1601-21**





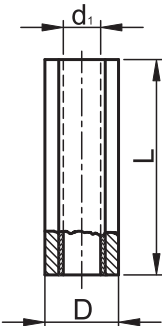

Mufe izolate

TRACON	d ₁ (mm)	D (mm)	L (mm)				
PTH	2	6	25	1-2.5	0.5-1.5	0.5-1.5	9006; 9006R; 9006RS
KTH	2.7	6.5	25	2.5-4	1.5-2.5	1.5-2.5	
STH	3.9	8	27	4-6	4-6	4	





RELEVANT STANDARD
MSZ-05-45.1601-1
MSZ-05-45.1601-21





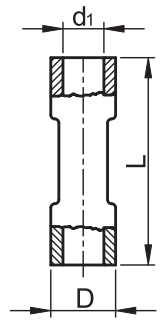





Mufe cu izolație termocontractabilă

TRACON	d ₁ (mm)	D (mm)	L (mm)				
ZSTHP	1.8	4.6	37	1-1.5	0.5-1.5	0.75-1	9006; 9006R; 9006RS
ZSTHK	2.6	5.4	37	2.5-4	1.5-2.5	1.5-2.5	
ZSTHS	3.6	6.6	42	4-6	4-6	2.5-4	

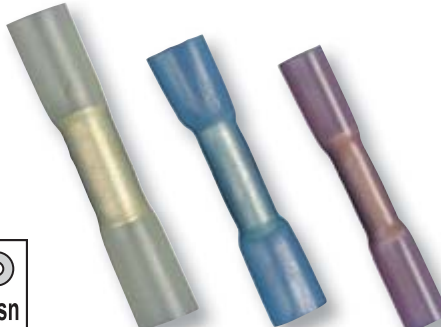





RELEVANT STANDARD
MSZ-05-45.1601-1
MSZ-05-45.1601-21





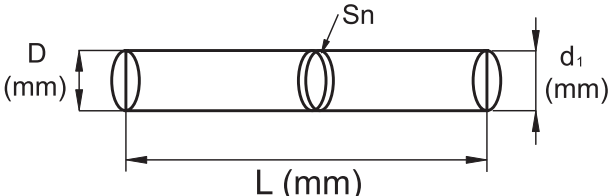

Manșon termocontractabil cu staniu

TRACON	d ₁ (mm)	D (mm)	L (mm)		
THSN0,5	2	2,5	24		0.5-1
THSN1	2,6	4,4	40		1-1.5
THSN2,5	4,2	6,2	42		2.5-4
THSN6	6	7	40		4-6









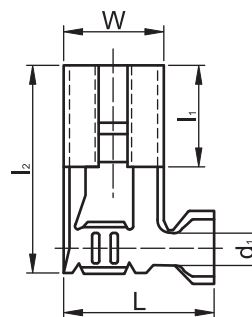
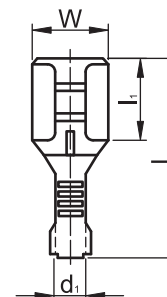
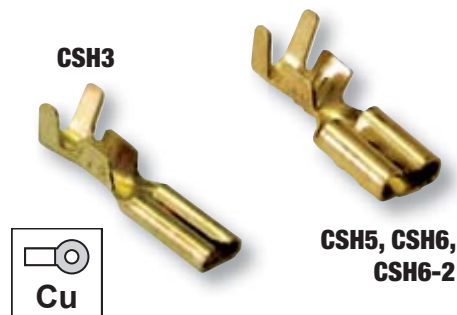
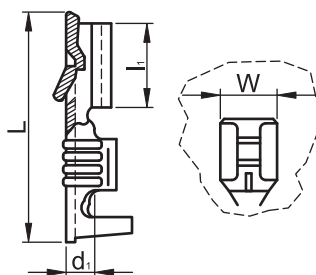
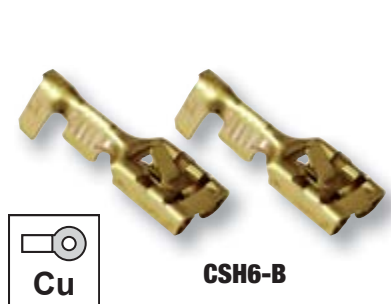

Mufe glisante tip "mamă"

TRACON		d ₁ (mm)	L (mm)	l ₁ (mm)	l ₂ (mm)	W (mm)		
CSH3	2.8 × 0.5	2.7	15.5	6.7	-	3.8	0.5-1	
CSH5	4.8 × 0.5	3.1	15.5	6.4	-	5.7	0.5-1	
CSH6	6.3 × 0.8	3.7	19.5	7.7	-	7.6	1-2.5	LY03B; LY03BR
CSH6-2	6.3 × 0.8	4.3	19	7.7	-	7.6	4-6	
CSH6-B	6.3 × 0.8	3.7	20	7.7	-	7.6	1-2.5	
CSH09B	6.3 × 0.8	3.7	13.4	8.3	16.7	8.8	1-2.5	-



Legendă pictograme **A/O**



RELEVANT STANDARD
EN 61210

EVPŪ CERTIFICATE NO.
02336/101/1/2001



Scule de presat recomandate:

TRACON	
LY03BR	0.5-6
LY03B	0.5-6

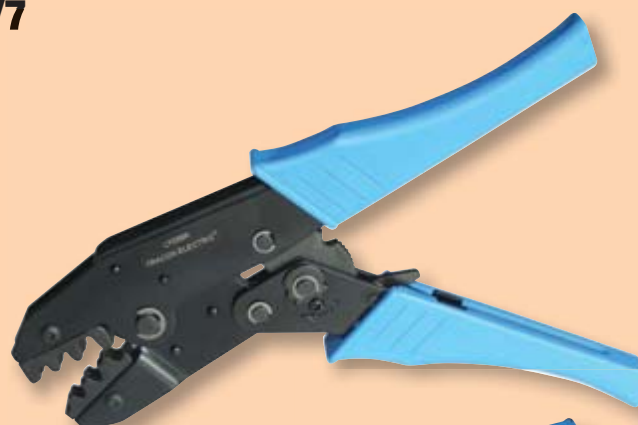
B/7



Fișe glisante tip "tată", neizolate

TRACON		d ₁ (mm)	L (mm)	I ₁ (mm)	W (mm)	 mm ²	
CS3	2.8 × 0.5	2.7	13.3	6	2.8	0.5-1	LY03B; LY03BR
CS5	4.8 × 0.5	3.1	17.9	6.4	4.8	0.5-1	
CS6	6.3 × 0.8	3.7	20.3	8.4	6.3	1-2.5	
CS6B	6.3 × 0.8	3.7	28.7	16.5	6.3	1-2.5	



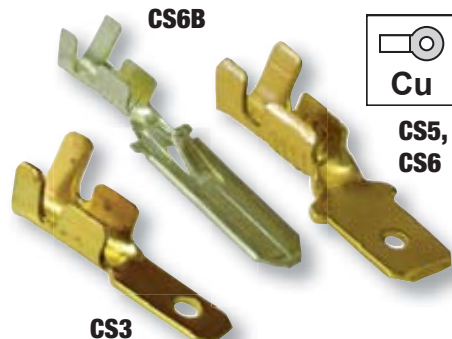
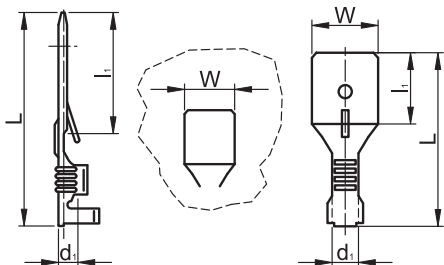

EVPŪ CERTIFICATE NO.
02336/101/1/2001

RELEVANT STANDARD
EN 61210



Fișe glisante cu mufă, neizolate

TRACON		d ₁ (mm)	L (mm)	I ₁ (mm)	I ₂ (mm)	W (mm)	 mm ²	
CSE	6.3 × 0.8	3.7	20	7.7	8	6.3	1-2.5	LY03B; LY03BR
CSEL	6.3 × 0.8	-	18.8	7.7	8.1	6.3	1-2.5	



EVPŪ CERTIFICATE NO.
02336/101/1/2001

RELEVANT STANDARD
EN 61210

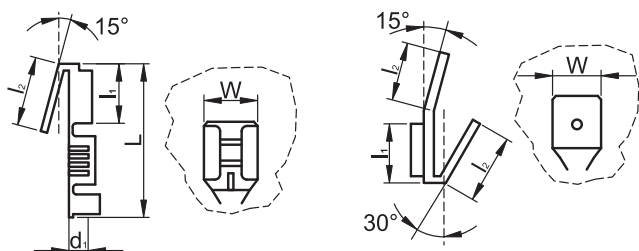

Fișe neizolate, de fixat cu șurub

TRACON		d (mm)	L (mm)	I ₁ (mm)	W (mm)	α
CSA-45-4	6.3 × 0.8	4.4	16.5	8.2	6.3	45°
CSA-45-5	6.3 × 0.8	5.2	16.5	8.2	6.3	45°
CSA-90-5	6.3 × 0.8	5.2	16.5	8.2	6.3	90°



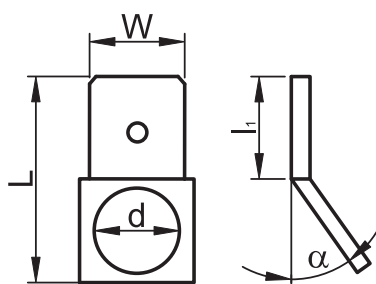

EVPŪ CERTIFICATE NO.
02336/101/1/2001

RELEVANT STANDARD
EN 61210



Izolație pt. fișă și mufă glisantă

TRACON	 	L (mm)	A (mm)	B (mm)	C (mm)
SZICSH5	CSH5	17.7	6.9	3	4.3
SZICSH6	CS5, CSH6	21.4	7.4	3.3	6.5
SZICS6	CS6	22.8	9	4.7	6.9

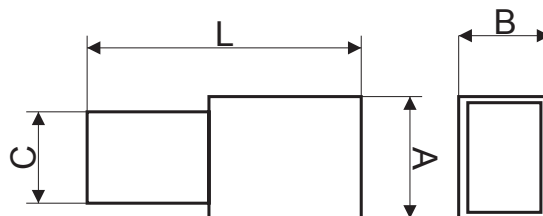
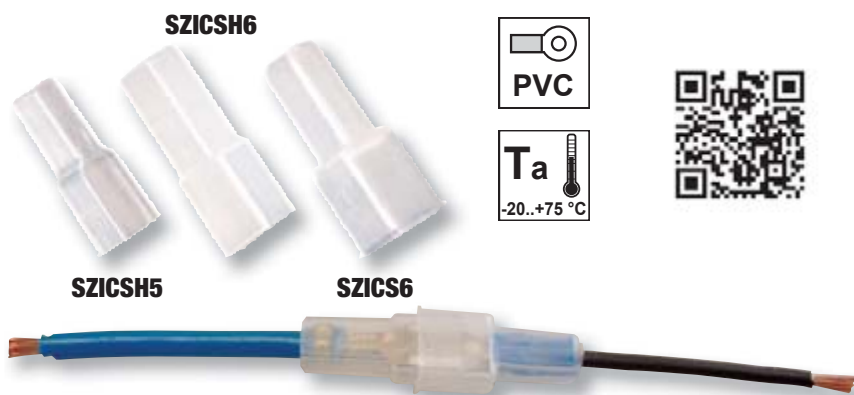

RELEVANT STANDARD
EN 61210

Papuci inelari neizolați

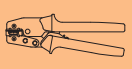
TRACON	d ₁ (mm)	d ₂ (mm)	B (mm)	L (mm)	 mm ²	
HSZ4	3.7	4.3	10	23.2	1-2.5	LY03B; LY03BR
HSZ5	3.7	5.4	10	23.2	1-2.5	
HSZ6	3.7	6.4	9.5	19.6	1-2.5	
HSZ8	4.9	8.4	13.5	25	2.5-4	

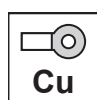

RELEVANT STANDARD
EN 61210

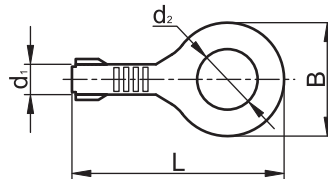

 Legendă pictograme **A/0**

Mufe glisante cu fișă, izolate

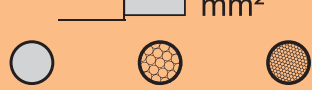
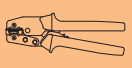

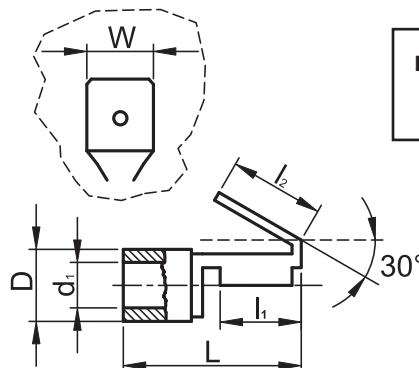
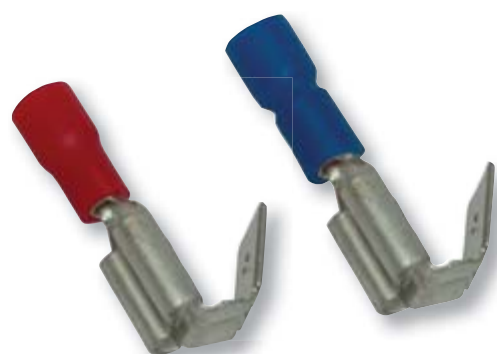

TRACON		d ₁ (mm)	D (mm)	L (mm)	l ₁ (mm)	W (mm)	 mm ²	
■ PCSE	6.3 × 0.8	1.7	4.6	22.6	8.6	6.3	1.5 1-1.5 0.5-1	9006; 9006R
■ KCSE	6.3 × 0.8	2.1	5.5	23.7	8.6	6.3	2.5 1.5-2.5 1.5	



RELEVANT STANDARD
EN 61210





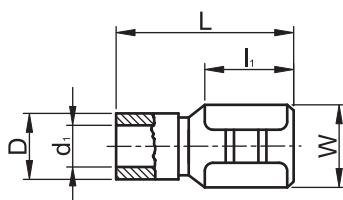

Mufe glisante izolate tip "mamă"

TRACON		d_1 (mm)	D (mm)	L (mm)	l_1 (mm)	W (mm)	 mm ²			
PCSH3	2.8 × 0.5	1.7	4.7	20.2	6.4	3.6	1.5	1-1.5	0.75-1	9006; 9006R
PCSH5	4.8 × 0.8	1.7	4.7	20.5	6.4	5.7	1.5	1-1.5	0.75-1	
PCSH6	6.3 × 0.8	1.7	4.7	22	7.5	7.2	1.5	1-1.5	0.75-1	
KCSH3	2.8 × 0.5	2.4	5.5	20.2	6.5	3.6	2.5-4	2.5	1.5	
KCSH5	4.8 × 0.8	2.4	5.5	20.8	6	5.7	2.5-4	2.5	1.5	
KCSH6	6.3 × 0.8	2.4	5.5	22	7.5	7.3	2.5-4	2.5	1.5	
SCSH6	6.3 × 0.8	3.4	6.5	23	7.5	7.3	6	4-6	4	



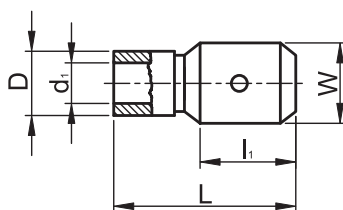

RELEVANT STANDARD
EN 61210

Fișe glisante izolate tip "tată"

TRACON		d_1 (mm)	D (mm)	L (mm)	l_1 (mm)	W (mm)	 mm ²			
PCS5	4.8 × 0.5	1.7	5.5	19	6.5	4.8	1.5	1-1.5	0.75-1	9006; 9006R
PCS6	6.3 × 0.8	1.7	5	22	7.5	6.3	1.5	1-1.5	0.75-1	
KCS5	4.8 × 0.5	2.4	6	19	6.5	4.8	2.5-4	2.5	1.5	
KCS6	6.3 × 0.8	2.4	5.5	22	7.5	6.3	2.5-4	2.5	1.5	
SCS6	6.3 × 0.8	3.5	6.5	23	7.5	6.3	6	4-6	4	

RELEVANT STANDARD
EN 61210

Mufe glisante complet izolate

TRACON		d_1 (mm)	D (mm)	L (mm)	l_1 (mm)	W (mm)	 mm ²			
PTCSH3	2.8 × 0.5	1.7	4.3	19	6.4	3.8	1.5	1-1.5	0.75-1	9006; 9006R
PTCSH5	4.8 × 0.8	1.7	4.7	20.5	6.4	5.7	1-1.5	0.75-1	0.75-1	
PTCSH6	6.3 × 0.8	1.7	4.7	22	7.5	7.6	1.5	1-1.5	0.75-1	
KTCSH3	2.8 × 0.5	2.5	5.8	19.6	6.5	3.8	2.5-4	2.5	1.5	
KTCSH5	4.8 × 0.8	2.5	5.6	20.2	6	5.7	2.5-4	2.5	1.5	
KTCSH6	6.3 × 0.8	2.5	5.6	22.6	7.5	7.6	2.5-4	2.5	1.5	
STCSH6	6.3 × 0.8	3.6	7.3	24.4	7.5	7.6	6	4-6	4	

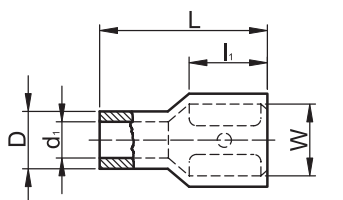
RELEVANT STANDARD
EN 61210

Tub de capăt (cap terminal) neizolat

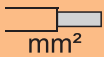
TRACON	 mm ²	D (mm)	d ₁ (mm)	S (mm)	L (mm)
E01NR6	0.5	1.3	1	0.2	6
E01NR	0.5	1.3	1	0.2	8
E01N	0.5	1.3	1	0.2	10
E02NR	0.75	1.5	1.2	0.2	8
E02N	0.75	1.5	1.2	0.2	10
E03NR	1	1.8	1.4	0.2	8
E03N	1	1.8	1.4	0.2	10
E04NR	1.5	2	1.7	0.2	8
E04N	1.5	2	1.7	0.2	10
E05NR	2.5	2.6	2.2	0.2	8
E05N	2.5	2.6	2.2	0.2	10
E06NR	4	3.2	2.8	0.2	9
E06N	4	3.2	2.8	0.2	12
E07NR	6	3.9	3.5	0.2	12
E07N	6	3.9	3.5	0.2	15
E08NR	10	4.9	4.5	0.2	12
E08N	10	4.9	4.5	0.2	15
E09N	16	6.2	5.8	0.2	15
E10N	25	7.9	7.5	0.2	16
E11N	35	8.7	8.3	0.25	16
E12N	50	10.9	10.3	0.3	20
E13N	70	15.3	13.5	0.4	22
E14N	95	16.8	14.6	0.4	32



E-Cu-sn

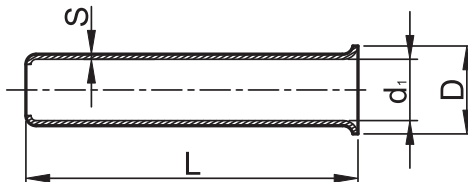

Pozițiile evidențiate prin fond colorat (oranji), sunt accesibile prompt, din stoc.



Scule recomandate pentru presat tuburi de capăt:

RELEVANT STANDARD
EN 61238-1























































RELEVANT STANDARD
MSZ-05-45.1601-26

EVPÚ CERTIFICATE NO.
02336/101/1/2001

TRACON	 mm ²
9102-LT	0.25-2.5
9004-LT	0.5-16
9039	6-16
9039A	1.5-6
9039B	10-35
9039AR	0.5-6
9039BR	10-35
9039A-SPEC	0.25-6
9039B-SPEC	6-16
9039-HEXA	0.25-6



Tub de capăt (cap terminal) izolat

TRACON	(NFC)*	TRACON	(DIN-VDE)**	mm ²	d ₁ (mm)	d ₂ (mm)	L (mm)	l (mm)	S ₁ (mm)	S ₂ (mm)
	E034		E134	0.25	0.8	1.5	10.4	6	0.15	0.25
			E135	0.25	0.8	1.5	12.8	8	0.15	0.25
			E136	0.34	0.8	1.9	10.4	6	0.15	0.3
			E137	0.34	0.8	1.9	12.8	8	0.15	0.3
			E010	0.5	1	2.6	12	6	0.15	0.25
			E020	0.5	1	2.6	14	8	0.15	0.25
			E030	0.5	1	2.6	16	10	0.15	0.25
			E040	0.75	1.2	2.8	12.4	6	0.15	0.25
	E05		E050	0.75	1.2	2.8	14.6	8	0.15	0.25
			E060	0.75	1.2	2.8	16.4	10	0.15	0.25
			E070	0.75	1.2	2.8	18.4	12	0.15	0.25
			E080	1	1.4	3	12.4	6	0.2	0.3
	E09		E090	1	1.4	3	14.6	8	0.2	0.3
			E100	1	1.4	3	16.4	10	0.2	0.3
			E110	1	1.4	3	18.4	12	0.2	0.3
	E13		E113	1.5	1.7	3.5	14.6	8	0.15	0.25
			E114	1.5	1.7	3.5	16.4	10	0.15	0.25
	E14			1.5	1.7	3.5	18	12	0.15	0.25
			E115	1.5	1.7	3.5	25	18	0.15	0.25
	E16		E116	2.5	2.3	4	15.2	8	0.15	0.25
			E117	2.5	2.3	4	19.2	12	0.15	0.25
			E118	2.5	2.3	4	25.2	18	0.15	0.25
	E19		E119	4	2.8	4.4	16.5	9	0.2	0.3
			E120	4	2.8	4.4	19.5	12	0.2	0.3
			E121	4	2.8	4.4	25.5	18	0.2	0.3
	E22		E122	6	3.5	6.3	20	12	0.2	0.3
			E123	6	3.5	6.3	26	18	0.2	0.3
	E24		E124	10	4.5	7.6	21.5	12	0.2	0.4
			E125	10	4.5	7.6	27.5	18	0.2	0.4
	E26		E126	16	5.8	8.8	22.2	12	0.2	0.4
			E127	16	5.8	8.8	28.2	18	0.2	0.4
	E28		E128	25	7.5	11.2	29	16	0.2	0.4
	E29		E129	25	7.5	11.2	35	22	0.2	0.4
	E30		E130	35	8.3	12.7	30	16	0.2	0.4
			E131	35	8.3	12.7	39	25	0.2	0.4
	E32		E132	50	10.3	15.3	36	20	0.3	0.6
			E133	50	10.3	15.3	41	25	0.3	0.6
			E140	70	13	16.7	37.5	21	0.5	0.75
			E142	95	14.5	18	43.6	25	0.6	1
			E144	120	16.6	20.4	48	27	0.6	1
			E146	150	20	23.5	58	32	0.6	1

* NFC = Standard național francez

** DIN-VDE = VDE - Standard german

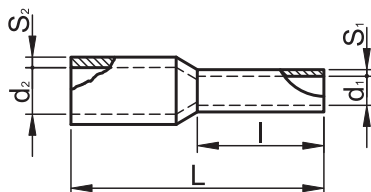















Pozițiile evidențiate prin fond colorat (oranji), sunt accesibile prompt, din stoc.

EVPŪ CERTIFICATE NO.
02336/101/1/2001

RELEVANT STANDARD
EN 61238-1
MSZ-05-45.1601-26



Tub de capăt (cap terminal) dublu, izolat

TRACON		d_1 (mm)	d_2 (mm)	L (mm)	l (mm)	S_1 (mm)	S_2 (mm)
 E20I	2 × 0.5	1.5	4.7	15	8	0.2	0.5
 E50I	2 × 0.75	1.8	5	16	8	0.2	0.4
 E50IH	2 × 0.75	1.8	5	17.5	10	0.2	0.5
 E90I	2 × 1.0	2.3	5.4	15	8	0.15	0.3
 E90IH	2 × 1.0	2.3	5.4	18	10	0.2	0.5
 E13IR	2 × 1.5	2.3	6.5	16	8	0.2	0.4
 E13I	2 × 1.5	2.3	6.5	20	12	0.15	0.3
 E16IR	2 × 2.5	2.8	7.8	20	10	0.2	0.5
 E16I	2 × 2.5	2.8	7.8	22.5	13	0.2	0.5
 E19I	2 × 4.0	3.8	9	23.5	12	0.2	0.5
 E22I	2 × 6.0	4.9	10.2	25.5	14	0.2	0.4
 E24I	2 × 10.0	6.5	13	26.5	14	0.2	0.5
 E26I	2 × 16.0	8.3	18.7	32	14	0.3	0.5





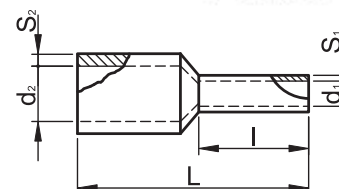

RELEVANT STANDARD
EN 61238-1
MSZ-05-45.1601-26

EVPÚ CERTIFICATE NO.
02336/101/1/2001



Conexiuni prin torsiune

TRACON		D (mm)	L (mm)
 TFM1	0.5-1.5	10	8.6
 TFM2	0.75-2.5	10	9.7
 TFM3	1-4	10	11.1
 TFM4	1.5-6	10	14



RELEVANT STANDARD
EN 60998-1

RELEVANT STANDARD
EN 60998-2-4

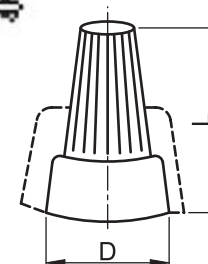

Tip de conductor: cupru, rigid

Clemă de legături fără șurub, care poate fi deschisă

TRACON	 mm ²	L (mm)	W (mm)	H (mm)
OV02,5-2	2 × 0.5-4	12.4	20.5	14.5
OV02,5-3	3 × 0.5-4	17	20.5	14.5
OV02,5-5	5 × 0.5-4	26.6	20.5	14.5
OV0T2,5-2	2 × 0.5-4	12.4	20.5	14.5
OV0T2,5-3	3 × 0.5-4	17	20.5	14.5
OV0T2,5-5	5 × 0.5-4	26.6	20.5	14.5









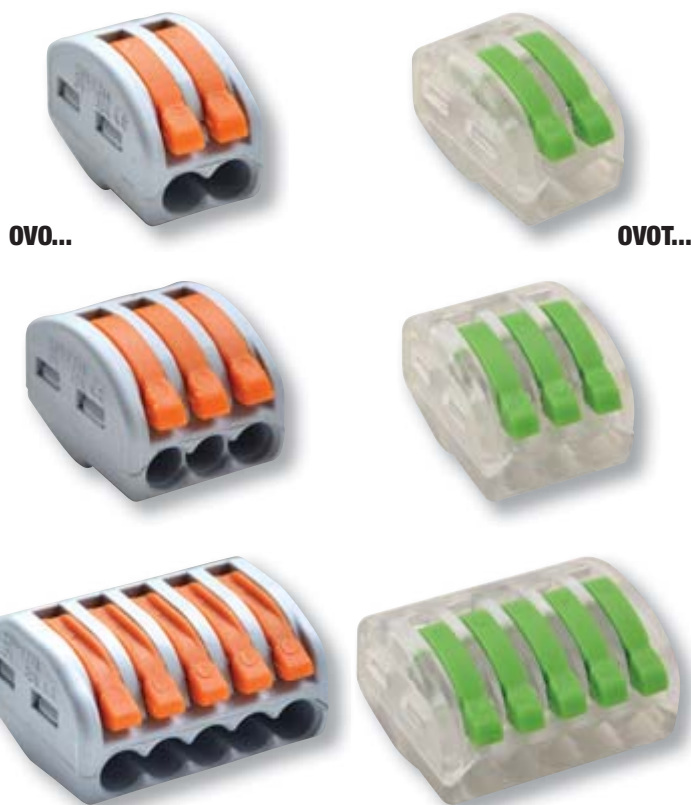
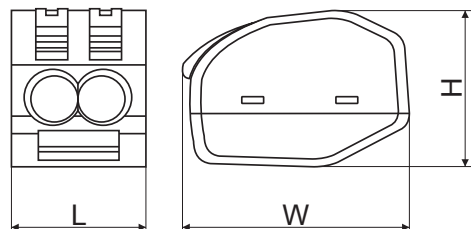



















Cleme de legătură fără șurub

TRACON	 mm ²	L (mm)	W (mm)	H (mm)
 TRC252	2 × 0.5-4	19	10.5	9.5
 TRC253	3 × 0.5-4	19	13.5	9.5
 TRC254	4 × 0.5-4	19	17.5	9.5
 TRC255	5 × 0.5-4	19	21	9.5
 TRC258	8 × 0.5-4	19	17.5	16.5
 RV02,5-2	2 × 0.5-2.5	16.6	10	6
 RV02,5-3	3 × 0.5-2.5	16.6	13.9	6
 RV02,5-4	4 × 0.5-2.5	16.6	18	6
 RV02,5-5	5 × 0.5-2.5	16.6	22.2	6
 RV02,5-8	8 × 0.5-2.5	16.6	18.1	11



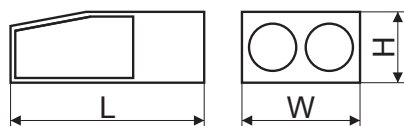
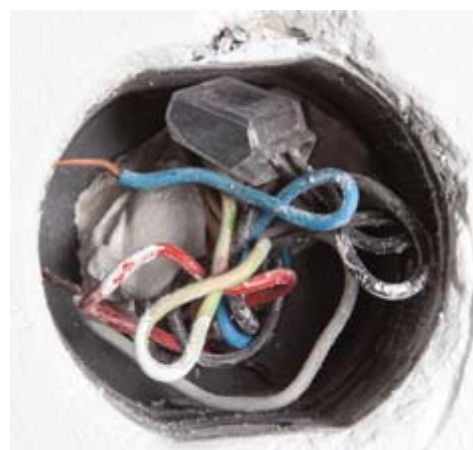
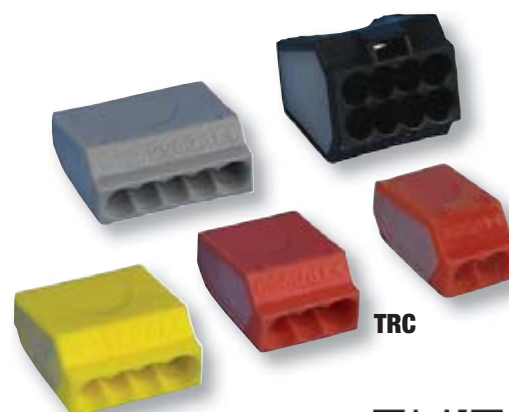





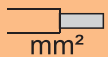

RELEVANT STANDARD
EN 60998-1
EN 60998-2-4



Cleme cu șurub pentru legături

TRACON		 mm ²	L (mm)	W (mm)	H (mm)
TRK4	pentru 4 legături, carcasă galbenă	1.5-4	19.5	13.4	13.4
TBT-2,5	Carcasă transparentă, 5 poli, 1 șurub	2.5	49.7	17.4	17.8
TBT-4	Carcasă transparentă, 5 poli, 1 șurub	4	58.5	20	20
TBT-6	Carcasă transparentă, 5 poli, 1 șurub	6	67.5	22.5	23.5
TBT-10	Carcasă transparentă, 5 poli, 1 șurub	10	82	27	27
TBT-16	Carcasă transparentă, 5 poli, 1 șurub	16	110	31	33.1
TBT-2,5/10	Carcasă transparentă, 10 poli, 1 șurub	2.5	100	17.4	18
TBT-4/10	Carcasă transparentă, 10 poli, 1 șurub	4	115.2	20.1	19.1
TBT-6/10	Carcasă transparentă, 10 poli, 1 șurub	6	134.2	22.6	22.5
TBT-10/10	Carcasă transparentă, 10 poli, 1 șurub	10	161.8	26.9	26.5
TBT-16/10	Carcasă transparentă, 10 poli, 1 șurub	16	220	31.3	32

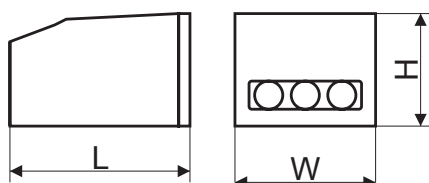
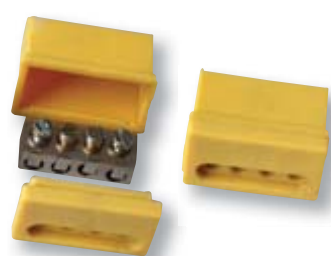

450 V AC

I_n max. 40 A

IP 20





T_a
-10..+55 °C

 **U_i**
500 V

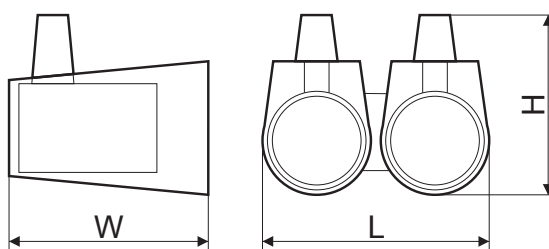

**RELEVANT STANDARD
EN 61210**

Derivații tip cuțit

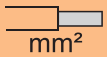
TRACON	L (mm)	W (mm)	H (mm)	 mm ²	I _n
■ PL	19.5	16	16	0.5-1	10 A
■ KL	19.5	16	11	1.5-2.5	20 A
■ SL	20	17	16	4-6	50 A





PVC

50 V DC

T_a
-20..+75 °C

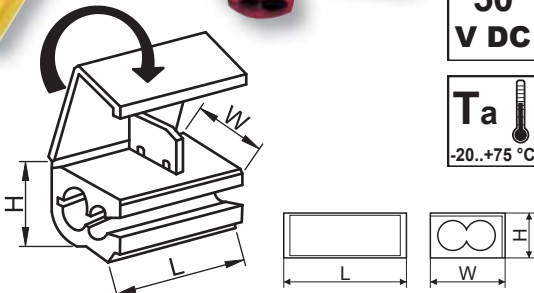





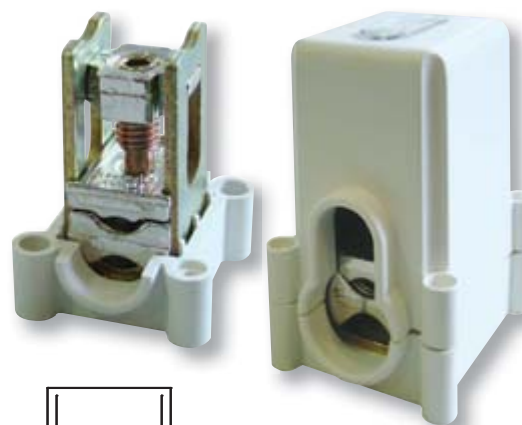
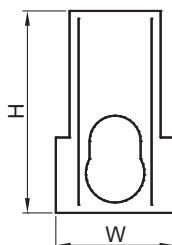
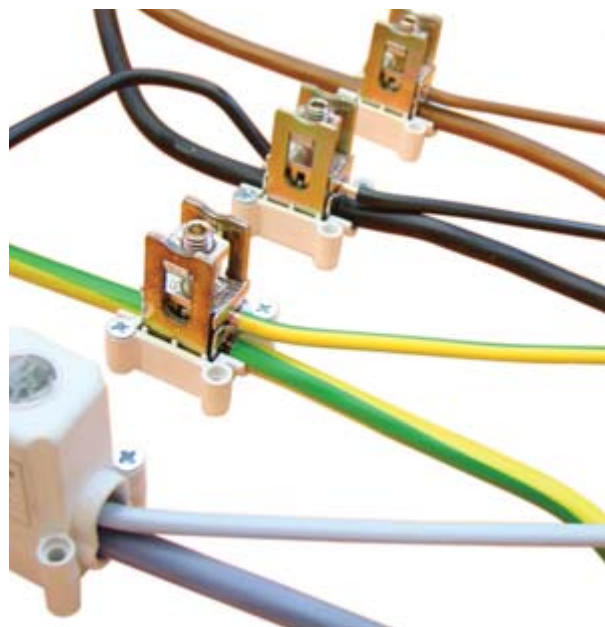

Clemă conductor de alimentare

TRACON	 mm ²	I_n	L (mm)	W (mm)	H (mm)
FFE35-50	35-50 / 25-35	150 A	60	30	50
FFE50-70	50-70 / 35-50	192 A	65	35	55
FFE70-95	70-95 / 50-70	232 A	70	40	60
FFE150-185	150-185 / 95-150	353 A	75	45	65
FFE95-240	95-240 / 70-185	415 A	80	50	70



RELEVANT STANDARD
EN 60999

Clemă șir distribuție, multicolor

TRACON	 mm ²				I_n		X 	IN	OUT	W1 (mm)	W2 (mm)
FLS35/4X9	1 × 35	1 × 25	9 × 4	9 × 2.5	125 A		1 × M8	9 × M4	16.3	20.4	
FLS35/10X4	1 × 35	1 × 25	4 × 10	4 × 6	125 A		1 × M8	4 × M5	16.3	20.4	
FLS50/16X4	1 × 50	1 × 35	4 × 16	4 × 10	150 A		1 × M8	4 × M6	24.2	28.2	
FLS70/10X8	1 × 70	1 × 50	8 × 10	8 × 6	192 A		1 × M10	8 × M6	32.2	36.1	

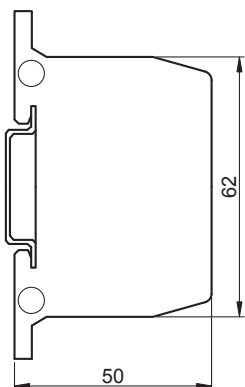
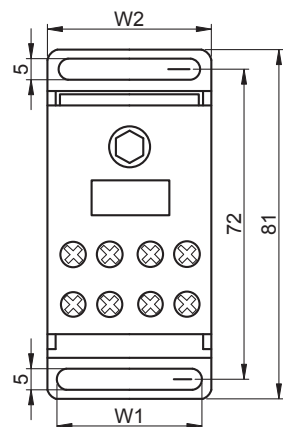

RELEVANT STANDARD
EN 60998-1



Clemă șir modulară pentru mufare, cu capac care se poate deschide

TRACON	xP	mm ²	mm ²	mm ²	mm ²	U _n	I _n		X	
FLS0T35	1P	1×35	1×35	1×35	1×35	1.000 V	125 A		M10	M10
FLS0T95	1P	1×95	1×70	1×95	1×70	1.000 V	250 A		M16	M16
FLS0T95L	1P	1×95	1×95	1×95	1×95	690 V	250 A		M10	M10



FLS0T35
FLS0T95

400 V AC

Cu

IP 20

PA6.6

35×7.5

V2 UL94

T_a
-20...+75 °C

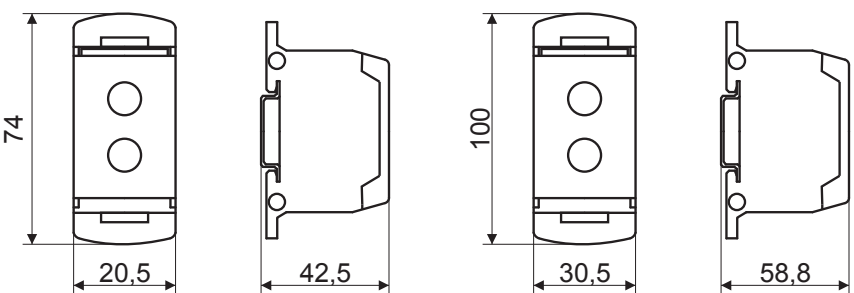

FLS0T35 **FLS0T95**



FLS0T95L

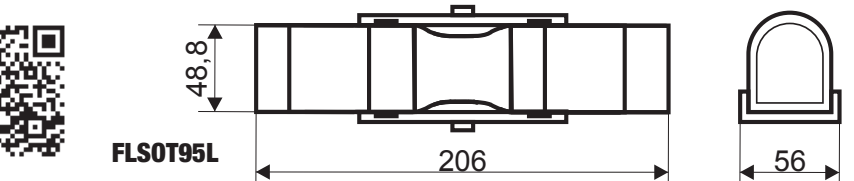

FLS0T95L

Distribuitoare modulare cu capac care se poate deschide

TRACON	xP	mm ²	mm ²	mm ²	mm ²	I _n		X	
FLS025-2P7	2P	1×25	1×25	3×10	3×6	100 A		M5	3×M4
FLS025-2P11	2P	2×25	2×25	4×10	4×6	100 A		M5	4×M4
FLS025-2P15	2P	2×25	2×25	6×10	6×6	100 A		M5	6×M4
				7×16	7×10				7×M5

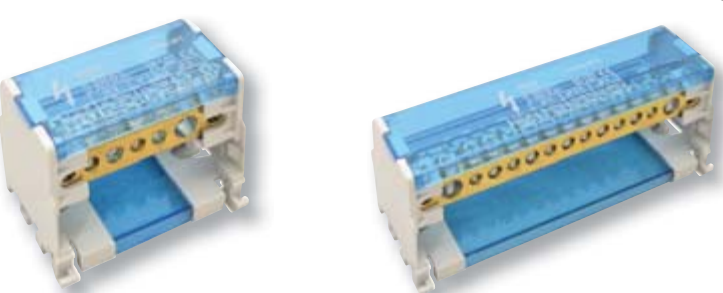

400 V AC

IP 20

35×7.5

T_a
-20...+75 °C

Cu

PA6.6

500 V U_i

V2 UL94



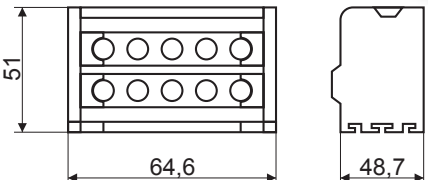

FLS025-2P7

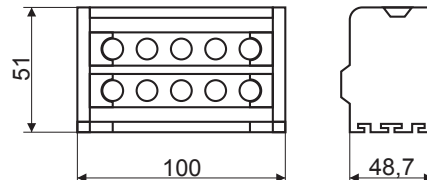

FLS025-2P11

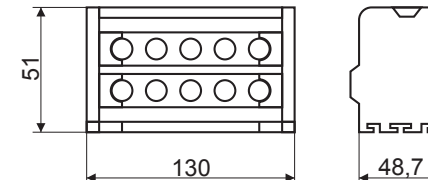

FLS025-2P15

Clemă șir distribuție cu capac care se poate deschide

TRACON	xP	mm ²				In	X	
FLS016	1P	3×16	3×16	4×10	4×6	80 A	3×M6	4×M4
FLS050	1P	1×50	1×35	6×25	6×16	125 A	1×M12	6×M6
FLS070	1P	1×70	1×50	6×25	6×16	160 A	1×M14	6×M6
FLS0120	1P	1×120	1×95	2×35	2×25	250 A	1×M16	5×M6
				4×16	4×10			4×M8
FLS0150	1P	1×150	1×120	2×35	2×25	400 A	1×M20	5×M6
				4×16	4×10			4×M8
FLS08X25	1P	 (8×25)	-	2×35	2×25	500 A	2×M8	5×M6
				4×16	4×10			4×M8
FLS050-3P	3P	1×50	1×35	6×16	6×10	175 A	M10	6×M6
		1×50	1×35	6×16	6×10		M10	6×M6
		1×50	1×35	6×16	6×10		M10	6×M6
FLS035-4P	4P	1×35	1×25	5×10	5×6	125 A	M5	5×M4
		1×35	1×25	2×25	2×16		2×M5	
		1×35	1×25	5×10	5×6		M5	5×M4
		1×35	1×25	2×25	2×16		2×M5	
FLS035-4P	4P	1×35	1×25	6×25	6×16	125 A	M5	6×M5
		1×35	1×25	4×16	4×10		4×M5	

RELEVANT STANDARD
IEC 60947-7-1

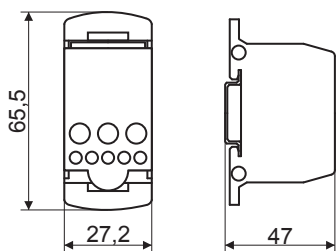

FLS016

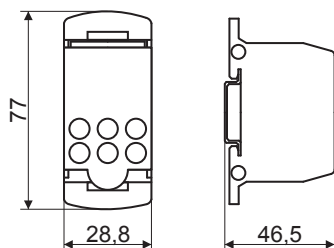

**FLS050
FLS070**

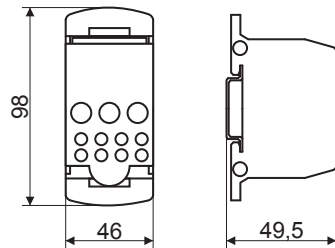

**FLS0120
FLS0150
FLS08X25**

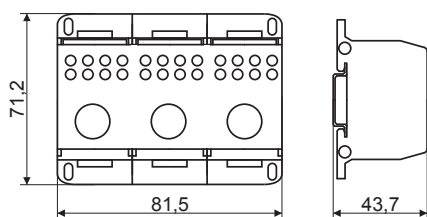



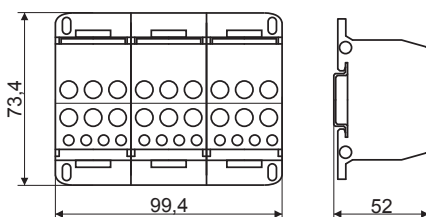









FLS035-3P

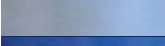

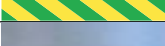

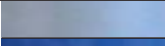



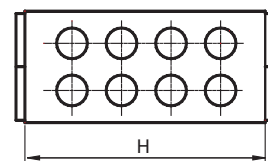
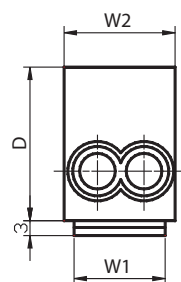

FLS035-4P









Clemă derivație

TRACON	mm ²				In		W1 (mm)	W1 (mm)	D (mm)	H (mm)
										
FLE-16							22.2	27.4	39.5	43.1
FLE-16K	2 × 16	2 × 10	2 × 16	2 × 10	76 A		22.2	27.4	39.5	43.1
FLE-16ZS							22.2	27.4	39.5	43.1
FLE-25							22.2	27.4	39.5	43.1
FLE-25K	2 × 25	2 × 16	2 × 25	2 × 16	101A		22.2	27.4	39.5	43.1
FLE-25ZS							22.2	27.4	39.5	43.1
FLE-35/25							20	26.9	43.6	53
FLE-35/25K	1 × 35	1 × 25	1 × 35	1 × 25	125 A		20	26.9	43.6	53
FLE-35/25ZS	1 × 25	1 × 16	1 × 25	1 × 16			20	26.9	43.6	53





 Cu	 PA6.6	 500 V	 V2 UL94	 400 V AC	 Ta -20...+75 °C	 35×7.5	 IP 20
--	---	--	---	--	---	--	---

Cleme șir din bachelită (cu lamelă)

TRACON		mm ²	X 	In	mm			a (mm)	b (mm)	c (mm)	M
											
BSK-6A		2.5	× 12	10 A	1.9	2.2	2.3	16.7	117.5	20.2	M3
BSK-15A		4	× 12	16 A	2.4	2.7	2.9	19	136.5	23.3	M3
BSK-30A		6	× 12	25 A	2.9	3.3	2.9	25.5	178.5	29.3	M3.5
BSK-40A		10	× 12	40 A	2.9	2.9	3.3	27.4	190	29.9	M4.5
ST63		10-25	× 1	63 A	1.9-3.7	2.2-6.6	2.3-6.3	40	65	17	M8
ST100		16-50	× 1	100 A	-	-	-	43	65	22	M10
ST160		25-70	× 1	160 A	-	-	-	45	65	15	M10



 Ta -20...+120 °C	 Nm 0.4 - 0.8	 E-Cu-sn
--	--	---

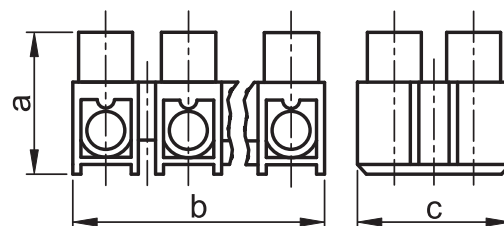















FIMKO IEC6E-CB CERTIFICATE NO. FI748, FI876, FI952

RELEVANT STANDARD EN 60998-1

RELEVANT STANDARD EN 60998-2-1

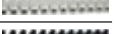
Cleme șir flexibile, profil H

Varianta constructivă tradițională



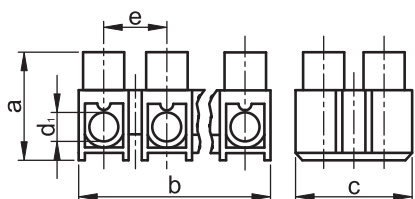











Profil	TRACON		mm ²	X 	In		∅ mm	d ₁ (mm)	a (mm)	b (mm)	c (mm)	e (mm)	
„H”	S3A-H		2.5	× 12	16 A	1.9	2.2	2.3	3	11	93.2	11	7.5
	SF3A-H		2.5	× 12	16 A	1.9	2.2	2.3	3	11	93.2	11	7.5
	S5A-H		4	× 12	25 A	2.4	2.7	2.9	3.2	13	114.8	13	9.7
	SF5A-H		4	× 12	25 A	2.4	2.7	2.9	3.2	13	114.8	13	9.7
	S10A-H		6	× 12	40 A	2.9	3.3	2.9	4.2	15.3	131.5	15.3	11.1
	SF10A-H		6	× 12	40 A	2.9	3.3	2.9	4.2	15.3	131.5	15.3	11.1
	S15A-H		10	× 12	50 A	2.9	3.3	2.9	4.5	16.6	137.3	22.5	11.5
	SF15A-H		10	× 12	50 A	2.9	3.3	2.9	4.5	16.6	137.3	22.5	11.5
	S30A-H		16	× 12	63 A	3.7	4.2	3.9	5.5	19.2	169	19.2	14.5
	SF30A-H		16	× 12	63 A	3.7	4.2	3.9	5.5	19.2	169	19.2	14.5
	S60A-H		25	× 12	80 A	-	6.6	6.3	6.6	24.4	191	24.4	16
	SF60A-H		25	× 12	80 A	-	6.6	6.3	6.6	24.4	191	24.4	16



RELEVANT STANDARD
EN 60998-1
EN 60998-2-1

Cleme șir flexibile, profil H





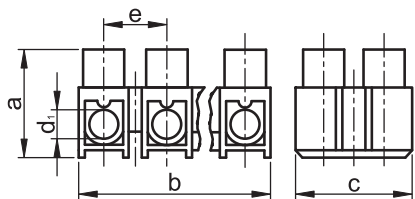





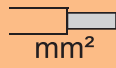













Varianta constructivă cu lamelă

Profil	TRACON		mm ²	X 	In		∅ mm	d ₁ (mm)	a (mm)	b (mm)	c (mm)	e (mm)	
„H”	S3A-H-L		2.5	× 12	16 A	1.9	2.2	2.3	3	11	93.2	11	7.5
	SF3A-H-L		2.5	× 12	16 A	1.9	2.2	2.3	3	11	93.2	11	7.5
	S5A-H-L		4	× 12	25 A	2.4	2.7	2.9	3.2	13	114.8	13	9.7
	SF5A-H-L		4	× 12	25 A	2.4	2.7	2.9	3.2	13	114.8	13	9.7
	S10A-H-L		6	× 12	40 A	2.9	3.3	2.9	4.2	15.3	131.5	15.3	11.1
	SF10A-H-L		6	× 12	40 A	2.9	3.3	2.9	4.2	15.3	131.5	15.3	11.1
	S15A-H-L		10	× 12	50 A	3.7	4.2	-	4.5	16.6	140	22.5	11.5
	SF15A-H-L		10	× 12	50 A	3.7	4.2	-	4.5	16.6	140	22.5	11.5
	S30A-H-L		16	× 12	63 A	3.7	4.2	3.9	5.5	19.2	169	19.2	14.5
	SF30A-H-L		16	× 12	63 A	3.7	4.2	3.9	5.5	19.2	169	19.2	14.5
	S60A-H-L		25	× 12	80 A	-	6.6	6.3	6.6	24.4	191	24.4	16
	SF60A-H-L		25	× 12	80 A	-	6.6	6.3	6.6	24.4	191	24.4	16



RELEVANT STANDARD
EN 60998-1
EN 60998-2-1

Cleme șir flexibile, profil U

Profil	TRACON	 mm ²	X 	I _n	 ∅ mm			d ₁ (mm)	a (mm)	b (mm)	c (mm)	e (mm)
S3A-U		2.5	× 12	16 A	1.9	2.2	2.3	3	10.8	91.4	15.6	7.6
S5A-U		4	× 12	25 A	2.4	2.7	2.9	3.3	12.8	112.5	15.5	9.5
S10A-U			× 12		2.9	3.3	2.9	4.2	15	128	20.6	10.8
SF10A-U			× 12		2.9	3.3	2.9	4.2	15	128	20.6	10.8
SK10A-U			× 12		2.9	3.3	2.9	4.2	15	128	20.6	10.8
SP10A-U		6	× 12	40 A	2.9	3.3	2.9	4.2	15	128	20.6	10.8
SS10A-U			× 12		2.9	3.3	2.9	4.2	15	128	20.6	10.8
SZ10A-U			× 12		2.9	3.3	2.9	4.2	15	128	20.6	10.8
S15A-U			× 12		2.9	2.9	3.3	4.5	16.6	137.3	22.5	12
SF15A-U			× 12		2.9	2.9	3.3	4.5	16.6	137.3	22.5	12
SK15A-U		10	× 12	50 A	2.9	2.9	3.3	4.5	16.6	137.3	22.5	12
SP15A-U			× 12		2.9	2.9	3.3	4.5	16.6	137.3	22.5	12
SS15A-U			× 12		2.9	2.9	3.3	4.5	16.6	137.3	22.5	12
SZ15A-U			× 12		2.9	2.9	3.3	4.5	16.6	137.3	22.5	12
S30A-U			× 12		3.7	4.2	3.9	5.6	19	164.5	25.3	19
SF30A-U		16	× 12	63 A	3.7	4.2	3.9	5.6	19	164.5	25.3	19
SK30A-U			× 12		3.7	4.2	3.9	5.6	19	164.5	25.3	19
S60A-U			× 12		-	6.6	6.3	6.6	24	185.5	29.2	15.8
SF60A-U		25	× 12	80 A	-	6.6	6.3	6.6	24	185.5	29.2	15.8
SK60A-U			× 12		-	6.6	6.3	6.6	24	185.5	29.2	15.8

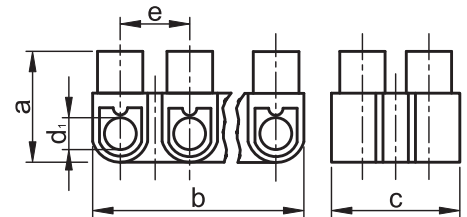

RELEVANT STANDARD
EN 60998-1
EN 60998-2-1

FIMKO IEC6E-CB CERTIFICATE NO.
FI748, FI876, FI952

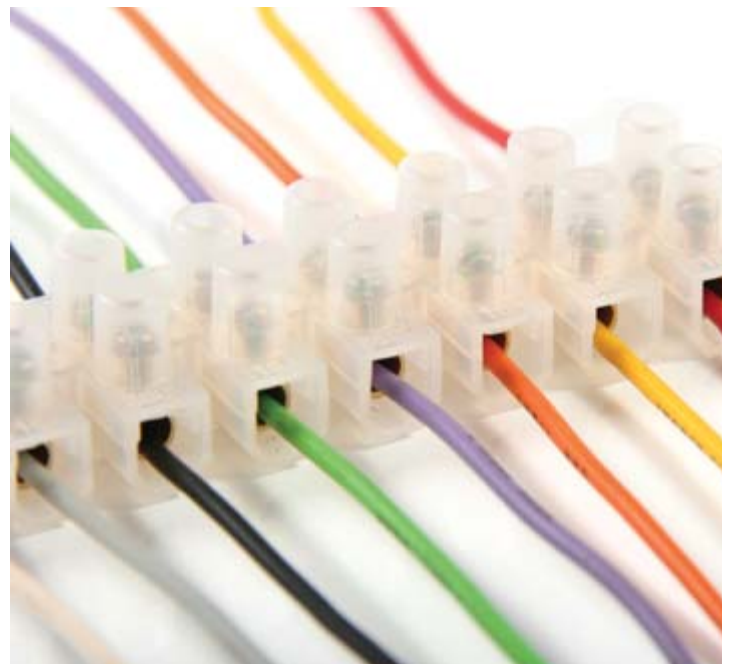



Cleme șir, fără șurub (cu arc), tip TSKD

Clemele șir fără șurub au fost proiectate în primul rând pentru conectarea sigură, rapidă și bună calitate a conductoarelor cu secțiunea între 0.08 mm² - 6.0 mm² a circuitelor de comandă, control.

În clemă se pot conecta conductoarele masive iar cele flexibile și foarte flexibile se conectează după sertizarea cu pini sau papuci tip pin.

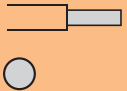
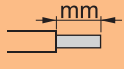
Elementele de contact sunt montate într-o carcasă din poliamidă rezistentă la temperaturi ridicate și cu rezistență mecanică mare. Carcasa este ignifugă conform UL94-V0 și are caracteristici superioare, având o astfel de formă constructivă încât clemele șir să poată fi montate cu șurub pe orice suprafață.

TRACON		U _n	I _n	 mm ²	W (mm)	L (mm)	H (mm)	 mm		
TSKD1,5		400 V	18 A	1.5	5	25.5	17.5	6	VLD1,5	SFD1,5
TSKD2,5		500 V	24 A	0.08-4	6	28	17	7	VLD2,5	SFD2,5
TSKD4		690 V	32 A	0.08-6	7	33.7	23	8	VLD4	SFD4
TSKD1,5D		400 V	18 A	2 × (0.08-1.5)	8	25.5	17.5	7	VLD1,5	SFD1,5
TSKD2,5D		500 V	24 A	2 × (0.08-4)	10	28	17	7	VLD2,5	SFD2,5
TSKD4D		690 V	32 A	2 × (0.08-6)	12	33.7	23	8	VLD4	SFD4

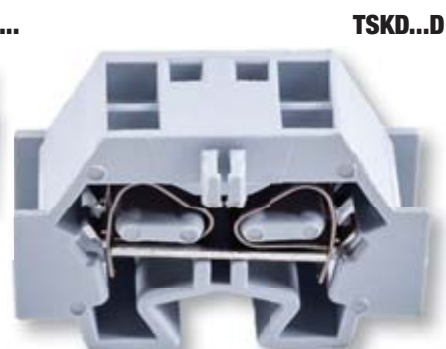
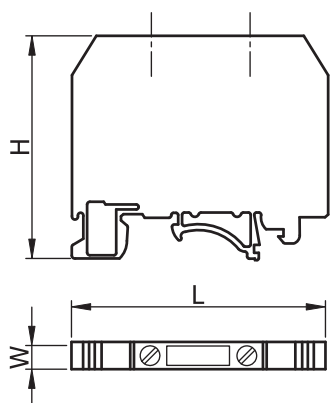

Accesorii

TRACON 

TSKDRE Adaptor fixare pe șină pentru seria TSKD

TRACON 

VLD1,5 Capac terminal pentru clemele TSKD1,5-TSKD1,5D

VLD2,5 Capac terminal pentru clemele TSKD2,5-TSKD2,5D

VLD4 Capac terminal pentru clemele TSKD4-TSKD4D

TRACON 

SFD1,5 Punte pentru clemele TSKD1,5-TSKD1,5D (2 module)

SFD2,5 Punte pentru clemele TSKD2,5-TSKD2,5D (2 module)

SFD4 Punte pentru clemele TSKD4-TSKD4D (2 module)



CITIȚI CODUL !

- Vezi noutățile noastre
- Fiți informat

Gama de produse se dezvoltă continuu și rapid!
Catalogul nostru reflectă situația din Octombrie 2017.
Pentru informații actualizate vizitați pagina noastră de internet!

Cleme șir TSKA

Familia de cleme TSKA este compusă din cleme cu șurub, izolate. Se folosesc în primul rând în domeniul industrial, atât pentru măsurare cât și pentru asigurarea legăturii electrice din circuitele de comandă și putere. Se pot conecta conductoare din cupru cu profil circular. Elementele de contact sunt montate într-o carcasă din poliamidă cu rezistență mare la șocuri și temperaturi ridicate.

Carcasa este ignifugă conform UL94-V0 și are caracteristici electrice superioare. Forma este adaptată montării pe șină de 35/7,5mm (omega) după normele EN 50022 cât și pe șină 32/15 (șină C). Temperatura de utilizare: -30 °C ... +90 °C.



Cleme de uz general

Se utilizează pentru conectarea conductorilor de fază cu secțiune maximă de 25 mm². O parte a carcasei din material plastic este deschisă. Ultima clemă din șir se poate închide cu capac terminal VL.



Cleme pentru curenți mari

Se utilizează pentru conectarea conductorilor de fază cu secțiune între 35 mm² și 185 mm². Contactele sunt formate din cadru metalic presat. Ambele părți ale carcasei din material plastic sunt închise.



Cleme de uz general (pt. nul)

Construcții identice cu clemele de uz general. Fiind albastre, se recomandă pentru conectarea conductorilor de nul, astfel se poate realiza o deosebire vizuală între faze și nul.



Cleme pentru curenți mari (pt. Nul)

Construcții identice cu clemele pentru curenți mari. Fiind albastre, se recomandă pentru conectarea conductorilor de nul, astfel se poate realiza o deosebire vizuală între faze și nul.



Cleme de pământare

Se folosesc pentru realizarea conexiunii electrice între conductorii de pământare verde/galben și șina omega legată la pământ. Se pot lega conductori de pământare (PE) și (PEN) conductori de pământare + nul.



Cleme etajate

Servesc la realizarea conexiunii conductorilor din două circuite separate. Cele două cleme una peste cealaltă pot fi folosite cu ușurință datorită formei. Se recomandă utilizarea lor când nu este loc suficient.



Cleme cu 3 borne

Se recomandă utilizarea lor atunci când este necesară realizarea conexiunii între conductori dintr-un circuit de secțiuni sau tipuri diferite.



Cleme cu siguranță fuzibilă

Cu soclu pentru siguranțe fuzibile cilindrice din sticlă pentru diferite valori ale curentului, care oferă informații despre starea siguranței cu ajutorul unei surse LED, astfel încât o posibilă problemă poate fi ușor identificată.



Cleme pentru măsurători

Cu ajutorul șinei de scurtcircuitare deschisă sau închisă face posibilă conectarea în serie sau în paralel a aparatelor de măsură în circuitul de măsurat. Cleva TSKA6S servește atât pentru strângerea conductorului cât și pentru fixarea bornei de măsură



Cleme de separare

Se pot folosi la curent nominal de max.16 A. Clemele de separare se pot folosi pentru separarea circuitelor, pentru verificări sau permanent, cu tensiune maximă de 500 V.



TÜV MEEI TEST DOCUMENTATION
28211721 001

TÜV MEEI TEST DOCUMENTATION
28211719 001

RELEVANT STANDARD
EN 60947-7-1
EN 60947-7-2

Accesorii

Șină de legătură SF

Se folosește pentru interconectarea clemelor în zona unde se introduc conductorii. Șina are două, trei sau zece picioare. Partea de sus este izolată cu material plastic împotriva atingerii accidentale.

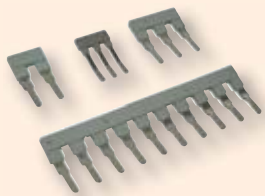

Șină de legătură USF

Se folosește pentru interconectarea clemelor în mijlocul lor. Disponibilă în 2, 3, respectiv 10 elemente până la clema de tipul TSKA50



Capac terminal VL

Se folosește pentru izolarea capetelor șirurilor de cleme. La montarea laolaltă a clemelor de diferite dimensiuni asigură protecție electrică între cele două cleme și protecție la atingere.



Placă punte

Se pot interconecta și cleme care nu sunt vecine. Plasticul de pe șurub asigură protecție la atingere accidentală. Dacă este nevoie de interconectarea a mai mult de 10 cleme, plăcile se pot suprapune.



Placă de separat circuite EL

Se pot utiliza pentru separarea electrică și vizuală a clemelor chiar și după ce au fost montate și legate cu punte.

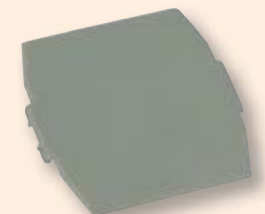

Placă de separat segmenti SEL

Se folosesc pentru separarea șirurilor de cleme atât electric cât și vizual.



Element de fixare RE

Se recomandă pentru fixarea clemelor pe șină 35/7,5 mm „omega” sau șină „C”. Se recomandă utilizarea lor pe ambele capete a șirului de cleme.

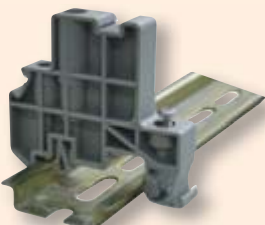

Marcaj șir de cleme KJ-A

Se poate fixa prin sistem click pe elementul de fixare RE1 și RE2, fiind potrivit pentru marcarea șirului de cleme prin așezarea corespunzătoare a plăcuței de marcarea 44x7 mm în forma de canelură.

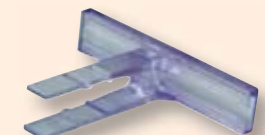

Etichete autocolante pentru marcaje tip „J”

Etichetele pentru marcajele tip „J” sunt disponibile în 4 mărimi. Aceste etichetele se găsesc pe coli A4 cu următoarele inscripționări: 1-100, L1, L2, L3, R, S, T, N e.t.c. Vezi variantele disponibile pe pagina de internet !



Marcaje J

Marcajele inscripționabile permit identificarea clemelor. Se comercializează în pachete de 10 bucăți, în patru mărimi diferite.



TÜV MEEI TEST DOCUMENTATION
28211721 001

TÜV MEEI TEST DOCUMENTATION
28211719 001

RELEVANT STANDARD
EN 60947-7-1
EN 60947-7-2



CITIȚI CODUL !

- Vezi noutățile noastre
- Fiți informat

Gama de produse se dezvoltă continuu și rapid!
Catalogul nostru reflectă situația din Octombrie 2017.
Pentru informații actualizate vizitați pagina noastră de internet!

TRACON		U_n	I_n		mm^2	W (mm)	L (mm)	H (mm)	M (mm)		mm
TSKA1,5	Clemă generală	500 V	17.5 A	0.14-1.5	0.14-1.5	4.3	43	41	M2		5
TSKA2,5	Clemă generală	800 V	32 A	0.2-4	0.2-2.5	5.5	43	41,2	M3		8
TSKA4	Clemă generală	800 V	41 A	0.2-6	0.2-4	6.5	43	46	M3		8
TSKA6	Clemă generală	800 V	57 A	0.2-10	0.2-6	8.5	43	46	M4		10
TSKA10	Clemă generală	800 V	76 A	0.5-16	0.5-10	10.2	43	46	M4		10
TSKA16	Clemă generală	800 V	101 A	2.5-25	2.5-25	12.2	43	52.5	M4		11
TSKA35	Clemă generală	1000 V	150 A	0.75-50	0.75-35	15.2	50	61	M6		16
TSKA50	Clemă generală	1000 V	150 A	16-50	25-50	20.5	71	76	M6		24
TSKA70	Clemă generală	1000 V	192 A	25-70	25-70	20.2	70.7	76,5	M6		23,5
TSKA95	Clemă generală	1000 V	232 A	25-95	35-95	25	83	90	M8		33
TSKA150	Clemă generală	1000 V	309 A	35-150	50-150	31	100	119	M10		40
TSKA240	Clemă generală	1000 V	415 A	70-240	70-240	36	100	131.5	M12		40
TSKA1,5-K	Clemă generală (nul) albastru	500 V	17.5 A	0.14-1.5	0.14-1.5	4.3	43	41	M2		5
TSKA2,5-K	Clemă generală (nul) albastru	800 V	32 A	0.2-4	0.2-2.5	5.5	43	41,2	M3		8
TSKA4-K	Clemă generală (nul) albastru	800 V	41 A	0.2-6	0.2-4	6.5	43	46	M3		8
TSKA6-K	Clemă generală (nul) albastru	800 V	57 A	0.2-10	0.2-6	8.3	43	46	M4		10
TSKA10-K	Clemă generală (nul) albastru	800 V	76 A	0.5-16	0.5-10	10.5	43	46	M4		10
TSKA16-K	Clemă generală (nul) albastru	800 V	101 A	2.5-25	2.5-25	12.5	43	52.5	M4		11
TSKA35-K	Clemă generală (nul) albastru	1000 V	150 A	0.75-50	0.75-35	15.7	51	62	M6		16
TSKA50-K	Clemă generală (nul) albastru	1000 V	150 A	16-50	25-50	20.5	71	76	M6		24
TSKA70-K	Clemă generală (nul) albastru	1000 V	192 A	25-70	25-70	20.2	70.7	76,5	M6		23,5
TSKA95-K	Clemă generală (nul) albastru	1000 V	232 A	25-95	35-95	25	83	90	M8		33
TSKA150-K	Clemă generală (nul) albastru	1000 V	309 A	35-150	50-150	31.5	101	112	M10		40
TSKA240-K	Clemă generală (nul) albastru	1000 V	415 A	70-240	70-240	36	100	131.5	M12		40
TSKA2.5JD	Clemă pământare	-	32 A	0.2-4	0.2-2.5	5.5	42.5	45.5	M3		8
TSKA4JD	Clemă pământare	-	41 A	0.2-6	0.2-4	6.5	43	46	M3		8
TSKA6JD	Clemă pământare	-	57 A	0.2-10	0.2-6	8.5	43	46	M4		10
TSKA1,5JD	Clemă pământare	500 V	17.5 A	0.14-1.5	0.14-1.5	4.3	43	41	M2		5
TSKA10JD	Clemă pământare	-	76 A	0.5-16	0.5-10	10.5	43	45.5	M4		10
TSKA16JD	Clemă pământare	-	101 A	2.5-25	2.5-25	12.5	43	52.5	M4		11
TSKA35JD	Clemă pământare	-	150 A	0.75-50	0.75-35	16	55	51	M6		16
TSKA50JD	Clemă pământare	-	150 A	16-50	25-50	20.5	71	77	M6		24
TSKA70JD	Clemă pământare	-	192 A	25-70	25-70	20.2	70.7	76,5	M6		23,5
TSKA95JD	Clemă pământare	-	230 A	95-95	35-95	25.3	83.3	89.7	M8		23,5
TSKA2,5/2	Clemă etajată	500 V	32 A	0.2-4	0.2-2.5	5.5	56.5	62	M3		8
TSKA2,5/2S	Clemă etajată	500V	24 A	0.2-2.5	0.2-2.5	5.5	62.1	47	M3		6
TSKA4/2	Clemă etajată	500 V	32 A	0.2-4	0.2-4	6.5	56.5	61	M3		8
TSKA4/3	Clemă cu 3borne	500 V	32 A	0.2-4	0.2-4	6.5	50	46	M3		8
TSKA4/4	Clemă cu 4borne	690 V	32 A	0.2-6	0.2-4	6.5	63.5	46	M3		8
TSKA10/3	Clemă cu 3borne	800 V	65 A	0.5-16	0.5-10	10	57	57.8	M4		5
TSKA4LEV	Clemă de separare	500 V	16 A	0.2-4	0.2-4	6.5	51.5	47	M3		8
TSKA6S	Clemă pt. măsurători	400 V	57 A	0.5-10	0.5-6	8.5	72.5	51	M4		13
TSKA6S/2	Clemă pt. măsurători	500 V	57 A	0.5-10	0.5-6	8.5	61.5	58	M3		8
TSKA4B	Clemă cu siguranță fuzibilă	800 V	6.3 A	0.2-4	0.2-4	8	73.6	55	M3		8
TSKA16B	Clemă cu siguranță fuzibilă	800 V	6.3 A	0.5-16	0.5-16	12.2	62.6	57.8	M4		9

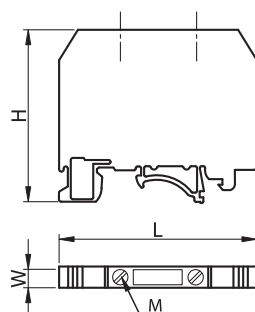
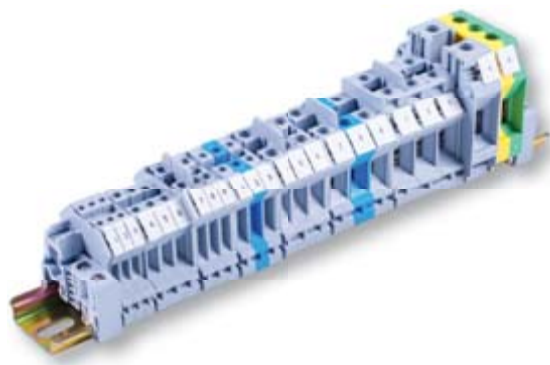

	2 module	3 module
(1)	USF35-2	USF35-3
(2)	USF50-2	USF50-3
(3)	Marcajul KJ-A se fixează pe elementul RE1	



0.4	USF1,5	-	-	-	VL4/10	USF1,5	-	SZEL101	J4	RE1
0.5	USF2,5	SF102	SF103	SF100	VL4/10	HL2,5	EL102	SZEL101	J5	RE1
0.5	USF4	SF112	SF113	SF110	VL4/10	HL4	EL102	SZEL101	J6	RE1
1.2	USF6	SF122	SF123	SF120	VL4/10	HL6	EL102	SZEL101	J8	RE1
1.2	USF10	SF132	SF133	SF130	VL4/10	HL10	EL102	SZEL101	J10	RE1
1.2	USF16	-	-	SF140	VL16	-	EL102	SZEL101	J10	RE1
2.5	USF35 ⁽¹⁾	-	-	SF150	-	-	EL102	-	J10	RE1
2.5	- ⁽²⁾	-	-	-	-	-	-	-	J10	RE2
1.8	USF50***	-	-	-	-	-	-	-	J10	RE1
3.5	-	-	-	-	-	-	-	-	J10	RE2
4.0	-	-	-	-	-	-	-	-	J10	RE2
14	-	-	-	-	-	-	-	-	J10	RE2
0.4	USF1,5	-	-	-	VL4/10	USF1,5	-	SZEL101	J4	RE1
0.5	USF2,5	SF102	SF103	SF100	VL4/10	HL2,5	EL102	SZEL101	J5	RE1
0.5	USF4	SF112	SF113	SF110	VL4/10	HL4	EL102	SZEL101	J6	RE1
1.2	USF6	SF122	SF123	SF120	VL4/10	HL6	EL102	SZEL101	J8	RE1
1.2	USF10	SF132	SF133	SF130	VL4/10	HL10	EL102	SZEL101	J10	RE1
1.2	USF16	-	-	SF140	VL16	-	EL102	SZEL101	J10	RE1
2.5	USF35 ⁽¹⁾	-	-	SF150	-	-	EL102	-	J10	RE1
2.5	- ⁽²⁾	-	-	-	-	-	-	-	J10	RE2
2.5	USF50***	-	-	-	-	-	-	-	J10	RE1
3.5	-	-	-	-	-	-	-	-	J10	RE2
4.0	-	-	-	-	-	-	-	-	J10	RE2
14	-	-	-	-	-	-	-	-	J10	RE2
0.5	-	-	-	-	-	-	-	-	J5	RE1
0.5	-	-	-	-	-	-	-	-	J6	RE1
1.2	-	-	-	-	-	-	-	-	J8	RE1
0.4	-	-	-	-	-	-	-	-	J4	RE1
1.2	-	-	-	-	-	-	-	-	J10	RE1
1.2	-	-	-	-	-	-	-	-	J10	RE1
2.5	-	-	-	-	-	-	-	-	J10	RE1
2.5	-	-	-	-	-	-	-	-	J10	RE2
2.5	-	-	-	-	-	-	-	-	J10	RE1
3.5	-	-	-	-	-	-	-	-	J10	RE1
0.5	-	-	-	-	VL3/5	-	EL101	-	J5	RE1
0.4	USF2,5	SF102	SF103	SF100	VL2,5/2S	HL2,5	EL102	-	J5	RE1
0.5	USF4	SF112	SF113	SF110	VL3/5	HL4	EL101	-	J6	RE1
0.5	USF4	SF112	SF113	SF110	VL4/3	HL4	EL102	-	J6	RE1
0.5	USF4	SF112	SF113	SF110	VL4/4	HL4	EL101	-	J6	RE1
1.2	USF10	SF132	SF133	SF130	-	-	EL100	-	J5	RE1
0.5	-	SF112	SF113	SF110	-	-	-	SZEL106	J6	RE1
1.2	-	-	-	-	VL6S	-	EL105	SZEL105	J8	RE1
0.5	-	SF122	SF123	SF120	VL6S/2	-	EL104	-	J8	RE1
0.5	-	-	-	-	-	-	-	-	J8	RE1
1.2	USF16	-	-	SF140	-	-	EL100	-	J8	RE1

*** 2-3 module

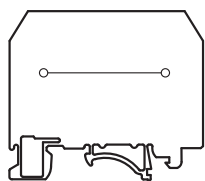

Clemă generală,
Clemă de nul

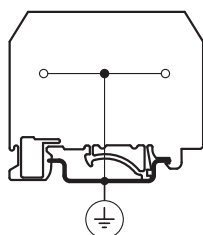

Cleme de
pământare

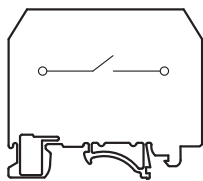

Clemă pt.
măsurători

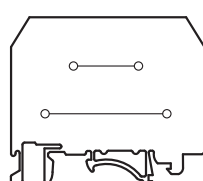

Clemă etajată

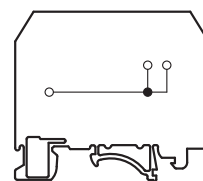

Clemă cu 3 borne

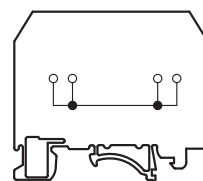

Clemă cu 4 borne

Cleme șir industriale, fără șurub, tip TSKB

Aceste cleme sunt destinate pentru realizarea conexiunilor rapide și sigure a conductorilor între $0,2 \text{ mm}^2 - 6,0 \text{ mm}^2$, în sisteme de distribuție și de comandă. Se pot folosi la conductori masivi fără papuci sau la cele flexibile și lițate cu papuci tubulari de capăt sau pini.

Componentele metalice ce asigură contactele sunt montate într-o carcasă din poliamidă cu caracteristici electrice deosebite, cu rezistență la temperaturi foarte ridicate și șocuri mecanice cu caracteristici ignifuge UL94-V0. Asigură posibilitate de montaj pe șină „omega” sau „C” conform normei EN 50022.

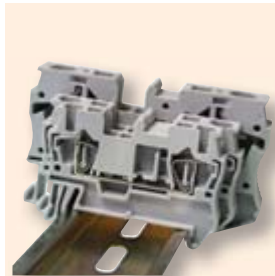

Cleme de uz general

Asigură conexiune între conductori de $1,5 \text{ mm}^2 - 6 \text{ mm}^2$. Conexiunea se face de sus, pt. economie de spațiu. Contactul este realizat cu ajutorul unui arc în interiorul clemei. Conexiunea se poate desface prin apăsarea arcului cu o șurubelniță.

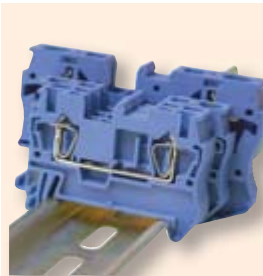

Cleme de nul

Construcție identică cu cele de uz general. Diferența dintre ele este culoarea albastră a carcasei, prin care se deosebesc cu ușurință traseele de fază de cele de nul.

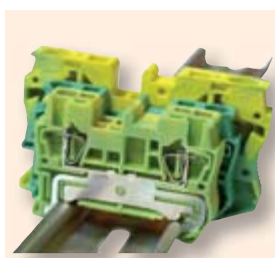

Cleme de pământare

Asigură conexiunea electrică și mecanică între conductorii verde/galben și șina pe care se montează clema legată la pământare. După construcție, clemele pot fi generale, cu trei sau patru contacte.

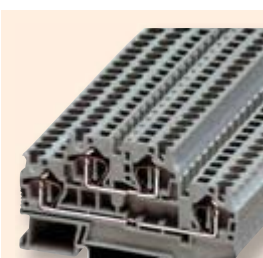

Cleme cu etaj

Se utilizează pentru conectarea conductorilor din două circuite separate. Datorită formei, cele două perechi de contacte suprapuse sunt ușor accesibile cu șurubelniță. Pot fi comandate și în culoare albastră (pt. nul).

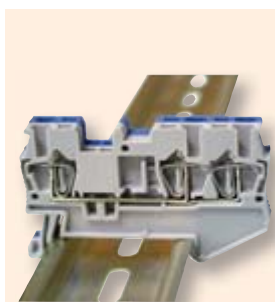

Cleme cu trei contacte

Se recomandă utilizarea lor când este nevoie de conectarea a trei conductori din același circuit, cu secțiuni sau de tipuri diferite. Prin construcție fac posibilă conectarea celor trei conductori la aceeași tensiune. Pot fi comandate și în culoare albastră (pt. nul).



Cleme cu patru contacte

Se recomandă utilizarea lor când este nevoie de conectarea a patru conductori din același circuit, cu secțiuni sau tipuri diferite. Prin construcție fac posibilă conectarea celor patru conductori la aceeași tensiune. Pot fi comandate și în culoare albastră (pt. nul).

RELEVANT STANDARD
EN 60947-7-1

RELEVANT STANDARD
EN 60947-7-2

TÜV MEEI TEST DOCUMENTATION
28211277 001

TÜV MEEI TEST DOCUMENTATION
28211276 001

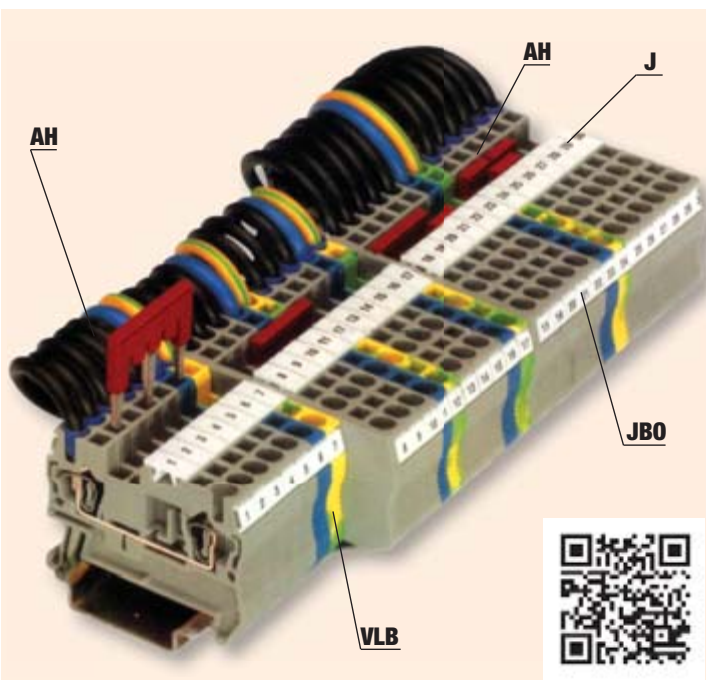

Accesorii

Punți de legătură AH ...

Disponibile în versiuni cu 2, 3, respectiv 10 poli. Prin dispunerea decalată a punților cu 2 poli, pot fi conectate un număr nelimitat de cleme. Utilizarea punților cu 3 sau 10 poli permite reducerea timpului de montaj, prin conectarea a 3 sau 10 poli printr-o singură operație.

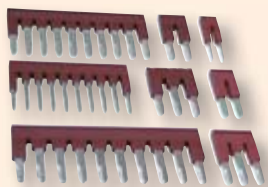

Marcaj șir de cleme KJ-A

Atașat elementului de fixare REB, asigură marcarea clemei șir, prin plasarea plăcii de marcaj 44x7 mm în locașul prevăzut.

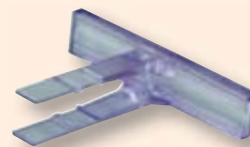

Element de fixare REB

Asigură montarea și fixarea clemelor șir pe șine de tip "omega" (35/7,5 mm) sau "C" (32/15 mm). Recomandăm instalarea sa la ambele capete ale șirului de cleme.



Etichete autocolante pentru marcaje tip „J”

Etichetele pentru marcajele tip „J” sunt disponibile în 4 mărimi. Aceste etichete se găsesc pe coli A4 cu următoarele inscripționări: 1-100, L1, L2, L3, R, S, T, N e.t.c. Vezi variantele disponibile pe pagina de internet !



Plăci terminale VLB

Asigură distanța de izolare corespunzătoare tensiunii de lucru, precum și protecția împotriva atingerii accidentale la capetele clemelor șir sau la juxtapunerea mai multor cleme.

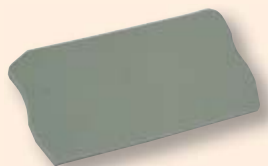

RELEVANT STANDARD
EN 60947-7-1

RELEVANT STANDARD
EN 60947-7-2

Plăci de marcaj JB și JBO

Servesc marcării clemelor șir în partea superioară (J) sau laterală (JBO). Aplicarea lor simplifică identificarea clemelor în cursul montajului sau al exploatarei ulterioare. Dimensiunile plăcilor sunt adaptate formei și dimensiunilor clemelor.



TÜV MEEI TEST DOCUMENTATION
28211277 001





TÜV MEEI TEST DOCUMENTATION
28211276 001

Arcul de oțel (1) apasă conductorul atașat (3) asupra șinei-conductor (2) din cupru electrolitic. Pentru conexiune, arcul trebuie adus în poziție de conectare cu ajutorul unei șurubelnițe obișnuite. În poziția de conectare al arcului, conductorul poate fi introdus în gaura prevăzută în arc.

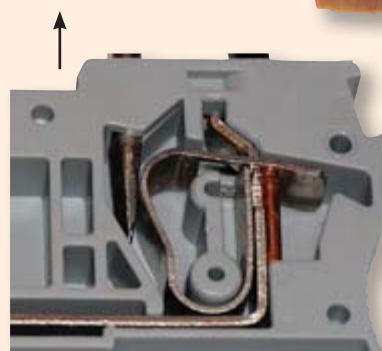
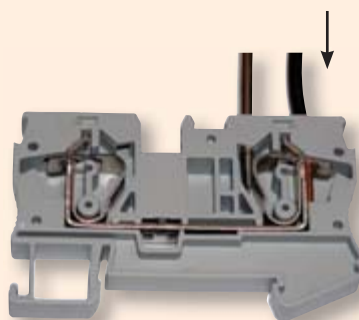
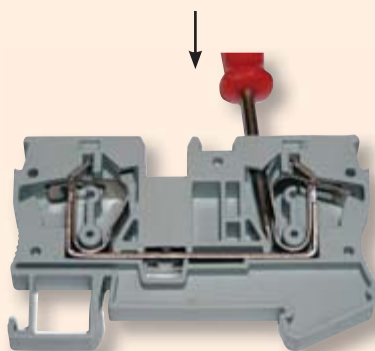
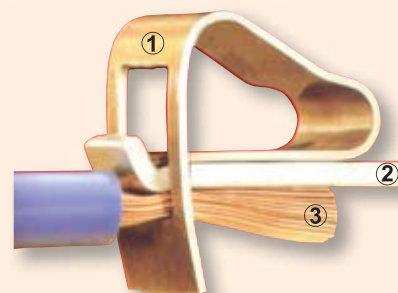
După îndepărtarea șurubelniței, arcul apasă conductorul contra șinei. Forța arcului asigură o rezistență de trecere de calitate similară cu contactele prin șurub.

Pentru îndepărtarea conductorului (desfacerea contactului), se procedează în mod asemănător: se apasă arcul cu șurubelnița și se extrage conductorul din gaura arcului.



TRACON		U_n	I_n	 mm ²		W (mm)	L (mm)	H (mm)
								
TSKB1,5	general	500 V	17.5 A	0.14-1.5	0.14-1.5	4.3	48.8	35.5
TSKB2,5	general	800 V	31 A	0.2-4	0.2-2.5	5.3	48.8	35.5
TSKB4	general	800 V	40 A	0.5-6	0.5-4	6.3	56	35.5
TSKB6	general	800 V	52 A	0.5-10	0.5-6	8.3	69.7	42.5
TSKB1,5K	Clemă generală (nul) albastru	500 V	17.5 A	0.14-1.5	0.14-1.5	4.3	48.8	35.5
TSKB2,5K	Clemă generală (nul) albastru	800 V	31 A	0.2-4	0.2-2.5	5.3	48.8	35.5
TSKB4K	Clemă generală (nul) albastru	800 V	40 A	0.5-6	0.5-4	6.3	56.5	35.5
TSKB6K	Clemă generală (nul) albastru	800 V	52 A	0.5-10	0.5-6	8.3	70	43
TSKB1/3	cu 3 borne	500 V	17.5 A	0.14-2.5	0.14-1.5	4.3	60.5	35.5
TSKB2/3	cu 3 borne	800 V	31 A	0.2-4	0.2-2.5	4.3	60.5	35.5
TSKB1/3K	nul, cu 3 borne	500 V	17.5 A	0.14-2.5	0.14-1.5	4.3	60.5	36.5
TSKB2/3K	nul, cu 3 borne	800 V	31 A	0.2-4	0.2-2.5	4.3	60.5	35.5
TSKB1/4	cu 4 borne	500 V	17.5 A	0.14-2.5	0.14-1.5	4.3	72	36.5
TSKB2/4	cu 4 borne	800 V	28 A	0.2-4	0.2-2.5	5.3	72	36.5
TSKB4/4	cu 4 borne	800 V	40 A	0.2-6	0.2-4	6.3	87	36.5
TSKB1/4K	nul, cu 4 borne	500 V	17.5 A	0.14-2.5	0.14-1.5	4.3	72	36.5
TSKB2/4K	nul, cu 4 borne	800 V	28 A	0.2-4	0.2-2.5	5.3	72	36.5
TSKB4/4K	nul, cu 4 borne	800 V	40 A	0.2-6	0.2-4	6.3	87	36.5
TSKB1/E	etajat	500 V	17.5 A	0.14-1.5	0.14-1.5	4.3	67.5	47.5
TSKB2/E	etajat	500 V	26 A	0.2-4	0.2-2.5	5.3	67.5	47.5
TSKB4/E	etajat	500 V	32 A	0.2-6	0.2-4	6.3	83.5	47.5
TSKB1/EK	nul, etajat	500 V	17.5 A	0.14-1.5	0.14-1.5	4.3	67.5	47.5
TSKB2/EK	nul, etajat	500 V	26 A	0.2-4	0.2-2.5	5.3	67.5	47.5
TSKB4/EK	nul, etajat	500 V	32 A	0.2-6	0.2-4	6.3	83.5	47.5
TSKB1,5JD	pentru pământare	-	17.5 A	0.14-1.5	0.14-1.5	4.3	48.8	36.5
TSKB2,5JD	pentru pământare	-	31 A	0.2-4	0.2-2.5	5.3	48.8	35.5
TSKB4JD	pentru pământare	-	41 A	0.5-6	0.5-6	6.3	55.9	35.5
TSKB6JD	pentru pământare	-	57 A	0.5-10	0.5-6	8.4	69.5	42.5
TSKB1JD/3	pentru pământare, 3 borne	-	17.5 A	0.14-1.5	0.14-1.5	4.3	60.5	36.5
TSKB2JD/3	pentru pământare, 3 borne	-	31 A	0.2-4	0.2-2.5	5.3	60.5	36.5
TSKB2JD/4	pentru pământare, 4 borne	-	30 A	0.2-4	0.2-2.5	5.3	72	36.5

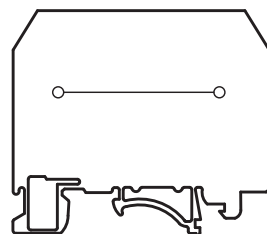



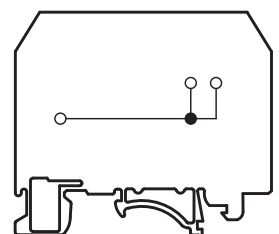

Clemă generală,
Clemă de nul

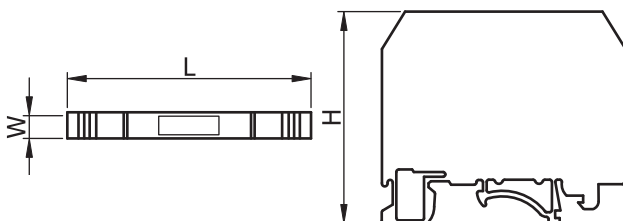
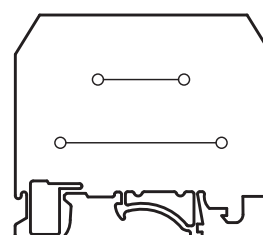
Clemă cu 3 borne

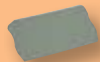

Clemă etajată

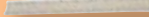

									
						frontal	lateral		
10	VLB2	AH1,5/2	AH1,5/3	AH1,5/10	J5	JB04	KJ-A	REB	
10	VLB2	AH2,5/2	AH2,5/3	AH2,5/10	J6	JB05	KJ-A	REB	
12	VLB4	AH4/2	AH4/3	AH4/10	J8	JB06	KJ-A	REB	
12	VLB6	AH6/2	AH6/3	AH6/10	J10	JB08	KJ-A	REB	
10	-	AH1,5/2	AH1,5/3	AH1,5/10	J5	JB04	KJ-A	REB	
10	-	AH2,5/2	AH2,5/3	AH2,5/10	J6	JB05	KJ-A	REB	
12	-	AH4/2	AH4/3	AH4/10	J8	JB06	KJ-A	REB	
12	-	AH6/2	AH6/3	AH6/10	J10	JB08	KJ-A	REB	
10	VLB2/3	AH1,5/2	AH1,5/3	AH1,5/10	J5	JB04	KJ-A	REB	
10	VLB2/3	AH2,5/2	AH2,5/3	AH2,5/10	J6	JB05	KJ-A	REB	
10	-	AH1,5/2	AH1,5/3	AH1,5/10	J5	JB04	KJ-A	REB	
10	-	AH2,5/2	AH2,5/3	AH2,5/10	J6	JB05	KJ-A	REB	
10	VLB2/4	AH1,5/2	AH1,5/3	AH1,5/10	J5	JB04	KJ-A	REB	
10	VLB2/4	AH2,5/2	AH2,5/3	AH2,5/10	J6	JB05	KJ-A	REB	
12	VLB4/4	AH4/2	AH4/3	AH4/10	J8	JB06	KJ-A	REB	
10	-	AH1,5/2	AH1,5/3	AH1,5/10	J5	JB04	KJ-A	REB	
10	-	AH2,5/2	AH2,5/3	AH2,5/10	J6	JB05	KJ-A	REB	
12	-	AH4/2	AH4/3	AH4/10	J8	JB06	KJ-A	REB	
10	VLB2/E	AH1,5/2	AH1,5/3	AH1,5/10	J5	JB04	KJ-A	REB	
10	VLB2/E	AH2,5/2	AH2,5/3	AH2,5/10	J6	JB05	KJ-A	REB	
12	VLB4/E	AH4/2	AH4/3	AH4/10	J8	JB06	KJ-A	REB	
10	-	AH1,5/2	AH1,5/3	AH1,5/10	J5	JB04	KJ-A	REB	
10	-	AH2,5/2	AH2,5/3	AH2,5/10	J6	JB05	KJ-A	REB	
12	-	AH4/2	AH4/3	AH4/10	J8	JB06	KJ-A	REB	
10	-	-	-	-	J5	JB04	KJ-A	REB	
10	-	-	-	-	J6	JB05	KJ-A	REB	
12	-	-	-	-	J8	JB06	KJ-A	REB	
12	-	-	-	-	J10	JB08	KJ-A	REB	
10	-	-	-	-	J5	JB04	KJ-A	REB	
10	-	-	-	-	J6	JB05	KJ-A	REB	
10	-	-	-	-	J6	JB05	KJ-A	REB	

cleme de pământare

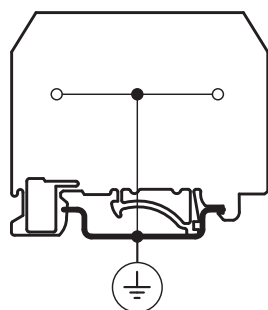

cleme de pământare cu 4 borne

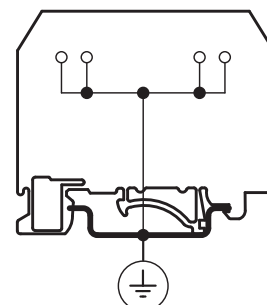

cleme cu 4 borne

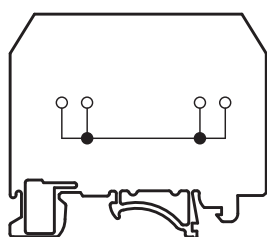

cleme de pământare cu 3 borne

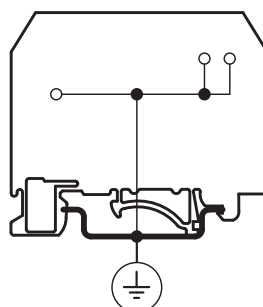

Cleme șir, fără șurub (cu arc), tip TSKC

Aceste cleme sunt destinate pentru realizarea conexiunilor rapide și sigure a conductorilor între $0,2 \text{ mm}^2 - 16 \text{ mm}^2$, în sisteme de distribuție și de comandă. Se pot folosi la conductori masivi fără papuci sau la cele flexibile și lițate cu papuci tubulari de capăt sau pini.

Componentele metalice ce asigură contactele sunt montate într-o carcasă din poliamidă cu caracteristici electrice deosebite, cu rezistență la temperaturi foarte ridicate și șocuri mecanice cu caracteristici ignifuge UL94-V0. Asigură posibilitate de montaj pe șină „omega” sau „C” conform normei EN 50022.



Cleme de uz general

Asigură conexiune între conductori de $2,5 \text{ mm}^2 - 16 \text{ mm}^2$. Conexiunea se face de sus, pt. economie de spațiu. Contactul este realizat cu ajutorul unui arc în interiorul clemei. Conexiunea se poate desface prin apăsarea arcului cu o șurubelniță.

TSKC..D



Cleme de nul

Construcție identică cu cele de uz general. Diferența dintre ele este culoarea albastră a carcasei, prin care se deosebesc cu ușurință traseele de fază de cele de nul.

TSKC..D-K

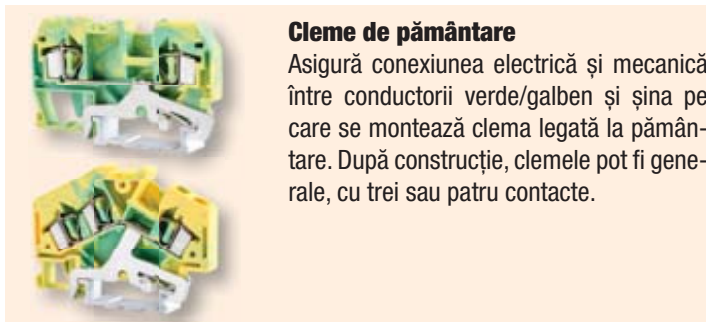

Cleme de pământare

Asigură conexiunea electrică și mecanică între conductorii verde/galben și șina pe care se montează clema legată la pământare. După construcție, clemele pot fi generale, cu trei sau patru contacte.

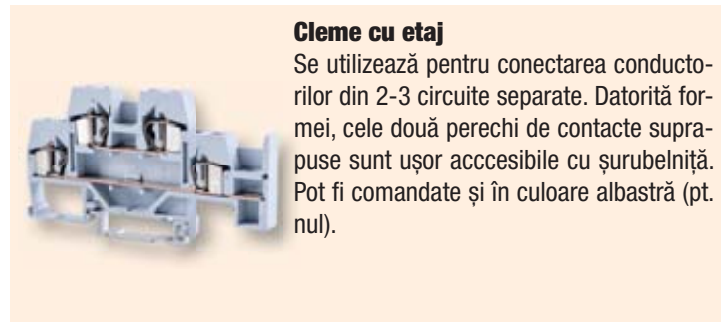

Cleme cu etaj

Se utilizează pentru conectarea conductorilor din 2-3 circuite separate. Datorită formei, cele două perechi de contacte suprapuse sunt ușor accesibile cu șurubelniță. Pot fi comandate și în culoare albastră (pt. nul).



Cleme cu trei contacte

Se recomandă utilizarea lor când este nevoie de conectarea a trei conductori din același circuit, cu secțiuni sau de tipuri diferite. Prin construcție fac posibilă conectarea celor trei conductori la aceeași tensiune. Pot fi comandate și în culoare albastră (pt. nul).

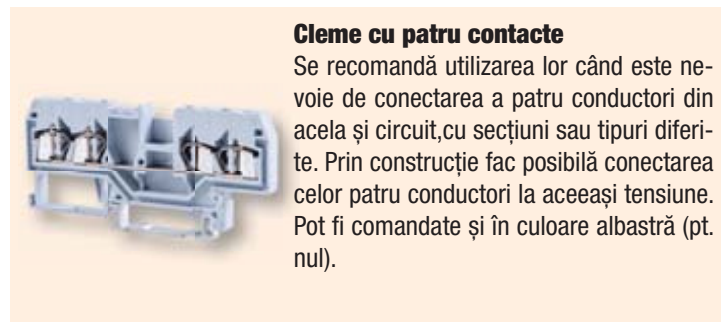

Cleme cu patru contacte

Se recomandă utilizarea lor când este nevoie de conectarea a patru conductori din același circuit, cu secțiuni sau tipuri diferite. Prin construcție fac posibilă conectarea celor patru conductori la aceeași tensiune. Pot fi comandate și în culoare albastră (pt. nul).



Cleme cu siguranță fuzibilă

Cu soclu pentru siguranțe fuzibile cilindrice din sticlă pentru diferite valori ale curentului, care oferă informații despre starea siguranței cu ajutorul unei surse LED, astfel încât o posibilă problemă poate fi ușor identificată.



RELEVANT STANDARD
EN 60947-7-1

RELEVANT STANDARD
EN 60947-7-2



Accesorii

Punți AHC..., SFC...

Sunt disponibile în varianta constructivă cu 2 poli, separat pentru conectarea clemelor vecine (AHC..) și separat pentru conectarea fiecărei a 2-a clemă (SFC..).



AHC

SFC

Marcaj șir de clemă KJ-A

Se poate fixa prin sistem click pe elementul de fixare REC3 fiind potrivit pentru marcarea șirului de clemă prin așezarea corespunzătoare a plăcuței de marcare 44x7 mm în forma de canelură.

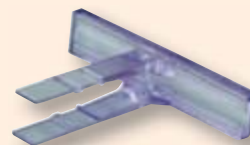

Element de fixare REC1, REC2, REC3

Se utilizează pentru fixarea clemelor pe șina 35/7,5 mm „omega” sau șina 32/15 „C”. Se recomandă utilizarea lor pe ambele capete ale șirului de clemă.



Etichete autocolante pentru marcaje tip „J”

Etichetele pentru marcajele tip „J” sunt disponibile în 4 mărimi. Aceste etichete se găsesc pe coli A4 cu următoarele inscripționări: 1-100, L1, L2, L3, R, S, T, N e.t.c. Vezi variantele disponibile în magazinul nostru virtual !



Capac terminal VLC

Se utilizează pentru izolarea capetelor șirurilor de clemă. La montarea clemelor de diferite dimensiuni unele lângă altele asigură distanța de izolare corespunzătoare tensiunii nominale și protecție la atingere.



Suport pentru marcaje clemă șir etajate TSKC-EJ

Cu ajutorul lui se poate asigura marcarea șirurilor de clemă cu 2-3 etaje și separat, pentru diferite etaje.



Marcaj TSKCJS

Cu ajutorul lor șirurile de clemă se pot inscripționa cu marcaje tip J. Prin utilizarea lor atât la instalare cât și la montajul ulterior identificarea devine mai simplă.

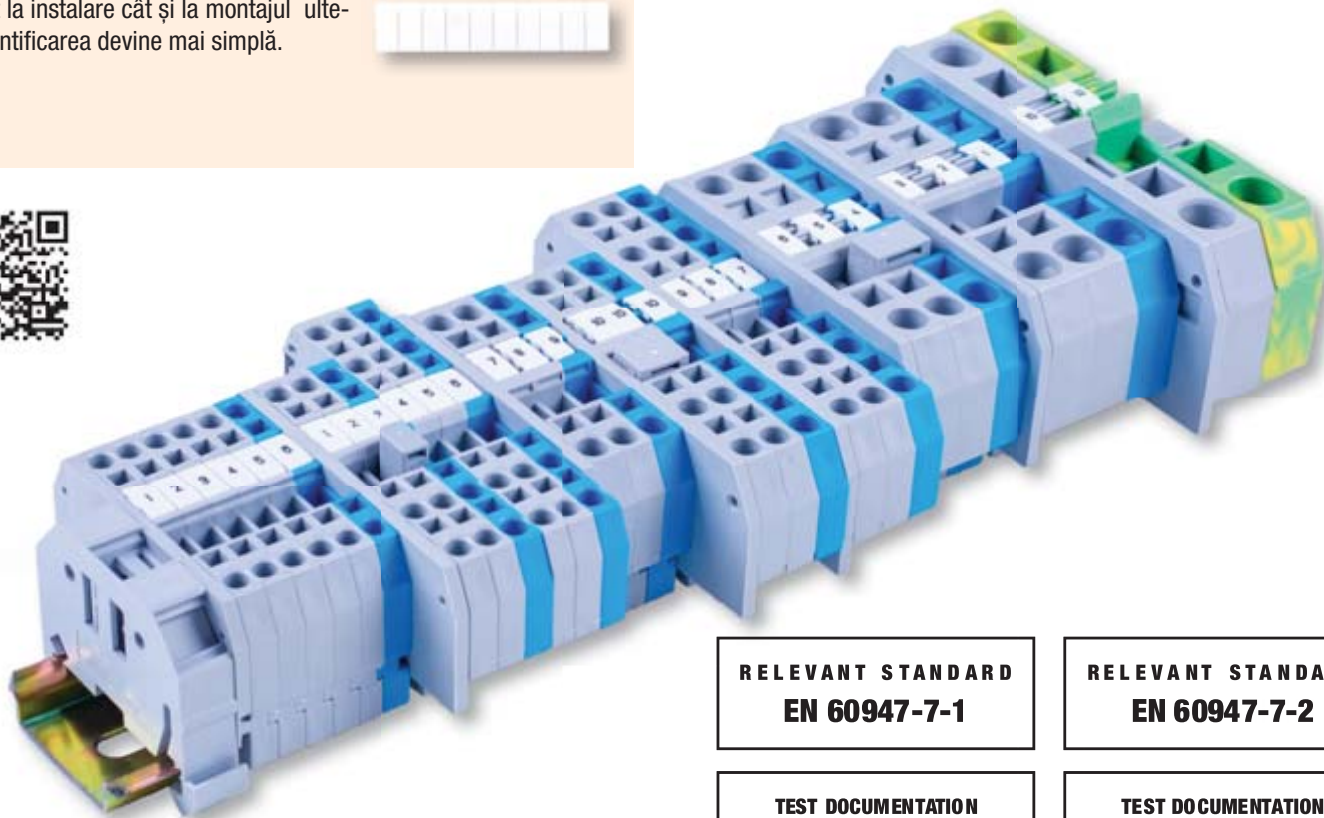



RELEVANT STANDARD
EN 60947-7-1

RELEVANT STANDARD
EN 60947-7-2

TEST DOCUMENTATION
TLZJ17031110317

TEST DOCUMENTATION
TLZJ17031110318

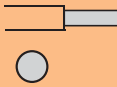
TRACON			U_n	I_n	 mm ²	W (mm)	L (mm)	H (mm)	
TSKC2,5	General	× 2	800 V	24 A	0.2-4	0.2-2.5	5	53.5	32.5
TSKC2,5/3	General	× 3	800 V	24 A	0.2-4	0.2-2.5	5	65	32.5
TSKC2,5/4	General	× 4	800 V	20 A	0.2-4	0.2-2.5	5	76.5	33
TSKC4	General	× 2	800 V	32 A	0.2-6	0.2-4	6	60	33.5
TSKC4/3	General	× 3	800 V	32 A	0.2-6	0.2-4	6	74.5	33
TSKC4/4	General	× 4	800 V	26 A	0.2-6	0.2-4	6	86.5	33
TSKC6	General	× 2	800 V	41 A	0.2-10	0.2-6	8.2	73.8	40
TSKC10	General	× 2	800 V	57 A	0.2-16	0.2-10	10	77.4	42
TSKC16	General	× 2	800 V	76 A	0.2-16	0.2-10	12	94	44.8
TSKC2,5JD	Pentru pământare	× 2	-	24 A	0.2-4	0.2-2.5	5	53.5	32.5
TSKC2,5/3JD	Pentru pământare	× 3	-	24 A	0.2-4	0.2-2.5	5	65	32.5
TSKC2,5/4JD	Pentru pământare	× 4	-	20 A	0.2-4	0.2-2.5	5	76.5	33
TSKC4JD	Pentru pământare	× 2	-	32 A	0.2-6	0.2-4	6	60	33.5
TSKC4/3JD	Pentru pământare	× 3	-	32 A	0.2-6	0.2-4	6	74.5	33
TSKC4/4JD	Pentru pământare	× 4	-	26 A	0.2-6	0.2-4	6	86.5	33
TSKC6JD	Pentru pământare	× 2	-	41 A	0.2-10	0.2-6	8.2	73.8	40
TSKC10JD	Pentru pământare	× 2	-	57 A	0.2-16	0.2-10	10	77.4	42
TSKC16JD	Pentru pământare	× 2	-	76 A	0.2-16	0.2-10	12	94	44.8
TSKC2,5-K	Clemă generală (nul) albastru	× 2	800 V	24 A	0.2-4	0.2-2.5	5	53.5	32.5
TSKC2,5/3-K	Clemă generală (nul) albastru	× 3	800 V	24 A	0.2-4	0.2-2.5	5	65	32.5
TSKC2,5/4-K	Clemă generală (nul) albastru	× 4	800 V	20 A	0.2-4	0.2-2.5	5	76.5	33
TSKC4-K	Clemă generală (nul) albastru	× 2	800 V	32 A	0.2-6	0.2-4	6	60	33.5
TSKC4/3-K	Clemă generală (nul) albastru	× 3	800 V	32 A	0.2-6	0.2-4	6	74.5	33
TSKC4/4-K	Clemă generală (nul) albastru	× 4	800 V	26 A	0.2-6	0.2-4	6	86.5	33
TSKC6-K	Clemă generală (nul) albastru	× 2	800 V	41 A	0.2-10	0.2-6	8.2	73.8	40
TSKC10-K	Clemă generală (nul) albastru	× 2	800 V	57 A	0.2-16	0.2-10	10	77.4	42
TSKC16-K	Clemă generală (nul) albastru	× 2	800 V	76 A	0.2-16	0.2-10	12	94	44.8
TSKC2,5/3D	General	× 3	800 V	24 A	0.2-4	0.2-2.5	5	50.5	41
TSKC2,5/4D	General	× 4	800 V	24 A	0.2-4	0.2-2.5	5	50.5	41
TSKC4/3D	General	× 3	800 V	32 A	0.2-6	0.2-4	6	62	41
TSKC2,5/3JDD	Pentru pământare	× 3	-	24 A	0.2-4	0.2-2.5	5	50.5	41
TSKC4/3JDD	Pentru pământare	× 3	-	32 A	0.2-6	0.2-4	6	62	41
TSKC2,5/3D-K	Clemă generală (nul) albastru	× 3	800 V	24 A	0.2-4	0.2-2.5	5	50.5	41
TSKC2,5/4D-K	Clemă generală (nul) albastru	× 4	800 V	24 A	0.2-4	0.2-2.5	5	50.5	41
TSKC4/3D-K	Clemă generală (nul) albastru	× 3	800 V	32 A	0.2-6	0.2-4	6	62	41
TSKC2,5EE	Etajat	2 × 2	500 V	20 A	0.2-4	0.2-2.5	5	75	44
TSKC4EE	Etajat	2 × 2	500 V	26 A	0.2-6	0.2-4	6	83	43
TSKC2,5EE	Etajat	3 × 2	500 V	20 A	0.2-4	0.2-2.5	5	104	55
TSKC4B	Clemă cu siguranță fuzibilă	× 2	250 V	6.3 A	0.2-6	0.2-4	6	60	83
TSKC6B	Clemă cu siguranță fuzibilă	× 2	220 V	10 A	0.2-10	0.2-6	12.8	62.3	60
TSKC6S	Clemă pt. măsurători	× 2	400 V	41 A	0.2-10	0.2-6	8	86	42

Legendă
pictograme

A/O

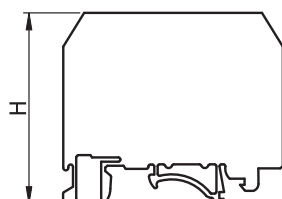
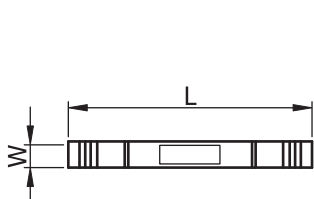
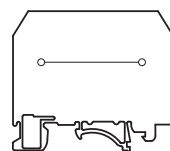
Clemă generală,
Clemă de nul

Clemă etajat

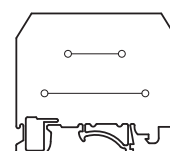

Clemă cu 3 borne

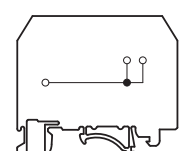

8		VLC2,5	SFC2,5	AHC2,5	TSKCJS	REC1, REC2, REC3
9		VLC2,5/3	SFC2,5	AHC2,5	TSKCJS	REC1, REC2, REC3
9		VLC2,5/4	SFC2,5	AHC2,5	TSKCJS	REC1, REC2, REC3
10		VLC4	SFC4	AHC4	TSKCJS	REC1, REC2, REC3
10		VLC4/3	SFC4	AHC4	TSKCJS	REC1, REC2, REC3
10		VLC4/4	SFC4	AHC4	TSKCJS	REC1, REC2, REC3
10		VLC6	SFC6	AHC6	TSKCJS	REC1, REC2, REC3
12		VLC10	SFC10	AHC10	TSKCJS	REC1, REC2, REC3
14		VLC16	SFC16	AHC16	TSKCJS	REC1, REC2, REC3
8		-	-	-	TSKCJS	REC1, REC2, REC3
9		-	-	-	TSKCJS	REC1, REC2, REC3
9		-	-	-	TSKCJS	REC1, REC2, REC3
10		-	-	-	TSKCJS	REC1, REC2, REC3
9		-	-	-	TSKCJS	REC1, REC2, REC3
10		-	-	-	TSKCJS	REC1, REC2, REC3
10		-	-	-	TSKCJS	REC1, REC2, REC3
12		-	-	-	TSKCJS	REC1, REC2, REC3
14		-	-	-	TSKCJS	REC1, REC2, REC3
8		VLC2,5	SFC2,5	AHC2,5	TSKCJS	REC1, REC2, REC3
9		VLC2,5/3	SFC2,5	AHC2,5	TSKCJS	REC1, REC2, REC3
9		VLC2,5/4	SFC2,5	AHC2,5	TSKCJS	REC1, REC2, REC3
10		VLC4	SFC4	AHC4	TSKCJS	REC1, REC2, REC3
9		VLC4/3	SFC4	AHC4	TSKCJS	REC1, REC2, REC3
10		VLC4/4	SFC4	AHC4	TSKCJS	REC1, REC2, REC3
10		VLC6	SFC6	AHC6	TSKCJS	REC1, REC2, REC3
12		VLC10	SFC10	AHC10	TSKCJS	REC1, REC2, REC3
14		VLC16	SFC16	AHC16	TSKCJS	REC1, REC2, REC3
9		VLC2,5/3D	SFC2,5	AHC2,5	TSKCJS	REC1, REC2, REC3
9		VLC2,5/3D	SFC2,5	AHC2,5	TSKCJS	REC1, REC2, REC3
9		VLC4/3D	SFC4	AHC4	TSKCJS	REC1, REC2, REC3
9		VLC2,5/3D	-	-	TSKCJS	REC1, REC2, REC3
9		VLC4/3D	-	-	TSKCJS	REC1, REC2, REC3
9		VLC2,5/3D	SFC2,5	AHC2,5	TSKCJS	REC1, REC2, REC3
9		VLC2,5/3D	SFC2,5	AHC2,5	TSKCJS	REC1, REC2, REC3
9		VLC4/3D	SFC4	AHC4	TSKCJS	REC1, REC2, REC3
9		VLC2,5E	SFC2,5	AHC2,5	TSKCJS+TSKC-EJ	REC1, REC2, REC3
10		VLC4E	SFC4	AHC4	TSKCJS+TSKC-EJ	REC1, REC2, REC3
9		VLC2,5EE	SFC2,5	AHC2,5	TSKCJS+TSKC-EJ	REC1, REC2, REC3
10		VLC4B	-	-	-	REC1, REC2, REC3
9		VLC6B	SFC6	AHC6	TSKCJS	REC1, REC2, REC3
11		VLC6S	SFC6	AHC6	TSKCJS	REC1, REC2, REC3

cleme cu 4 borne

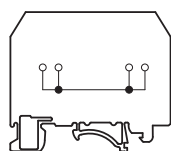

cleme de pământare

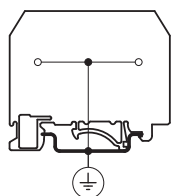

cleme de pământare cu 3 borne

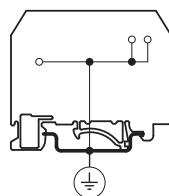

cleme de pământare cu 4 borne

