

# ideal lux®

IDEAL LUX s.r.l.  
Via Taglio Destro 32  
30035 Mirano (VE) Italy  
www.ideal-lux.com

IDEAL LUX Warehouse  
Via delle Industrie, 8/D  
30036 Santa Maria di Sala (Venezia)  
8.00 - 12.00 / 13.30 - 17.00

# ideal lux®



REV 03/08/2021

## Hotel AP2

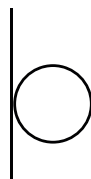

Lampada da parete  
Wall lamp  
Applique  
Wandleuchte  
Lámpara de pared  
Настенные светильники



LED

max 1 x 60W E27 + 1W LED /  
220~240V 50/60H  
- 8021696215709 ALL BLACK  
- 8021696215693 ALL WHITE  
- 8021696035949 BIANCO  
- 8021696103204 CANVAS  
- 8021696035956 NERO

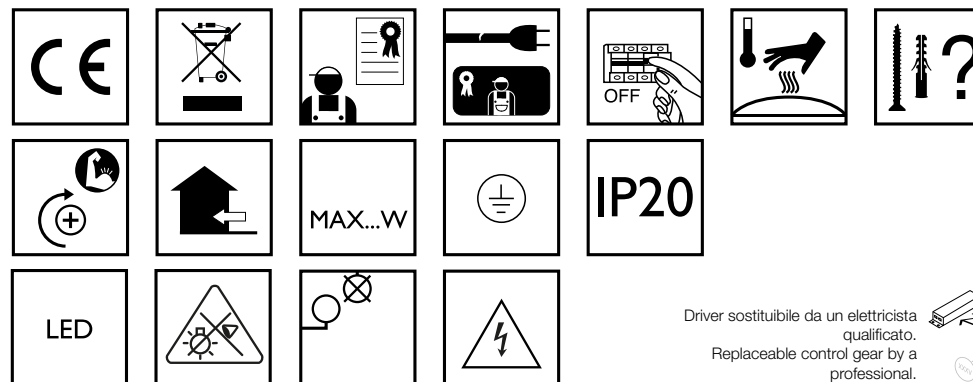
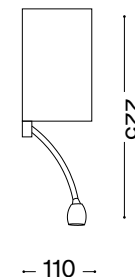
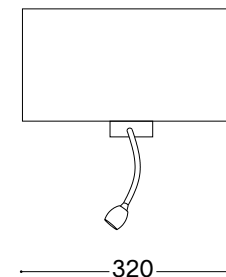

Questo prodotto è fornito con una sorgente luminosa di classe energetica /  
This product is provided with a light source with energy class of:  
**G**

Driver sostituibile da un elettricista qualificato.  
Replaceable control gear by a professional.

Fonte luminosa sostituibile da un elettricista qualificato.  
Replaceable light-source by a professional.

IDEAL LUX s.r.l.  
Via Taglio Destro 32  
30035 Mirano (VE) Italy  
www.ideal-lux.com

IDEAL LUX Warehouse  
Via delle Industrie, 8/D  
30036 Santa Maria di Sala (Venezia)  
8.00 - 12.00 / 13.30 - 17.00

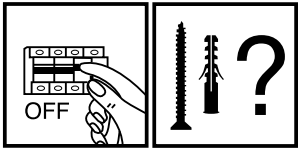

1

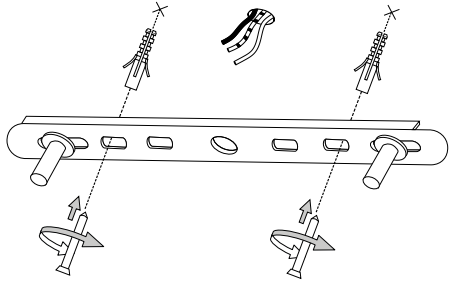

2

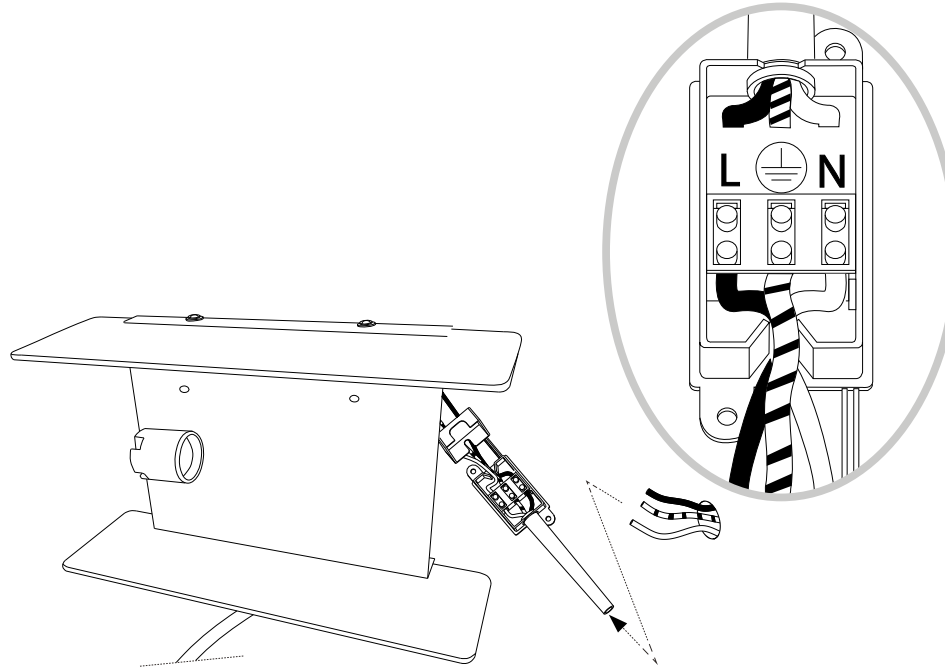

3

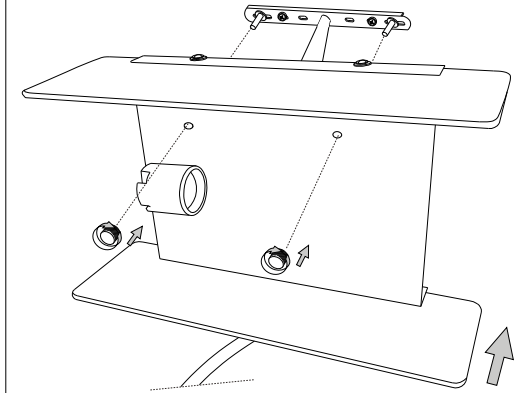

4

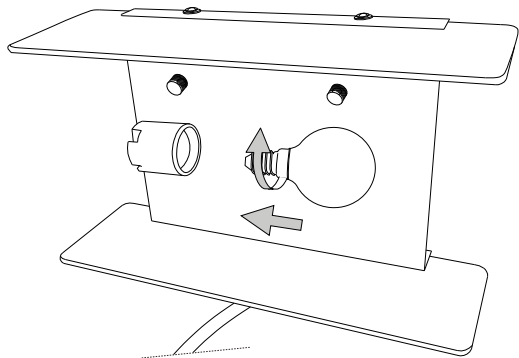

5

