

QUICK 28W CRI80 30° ON-OFF

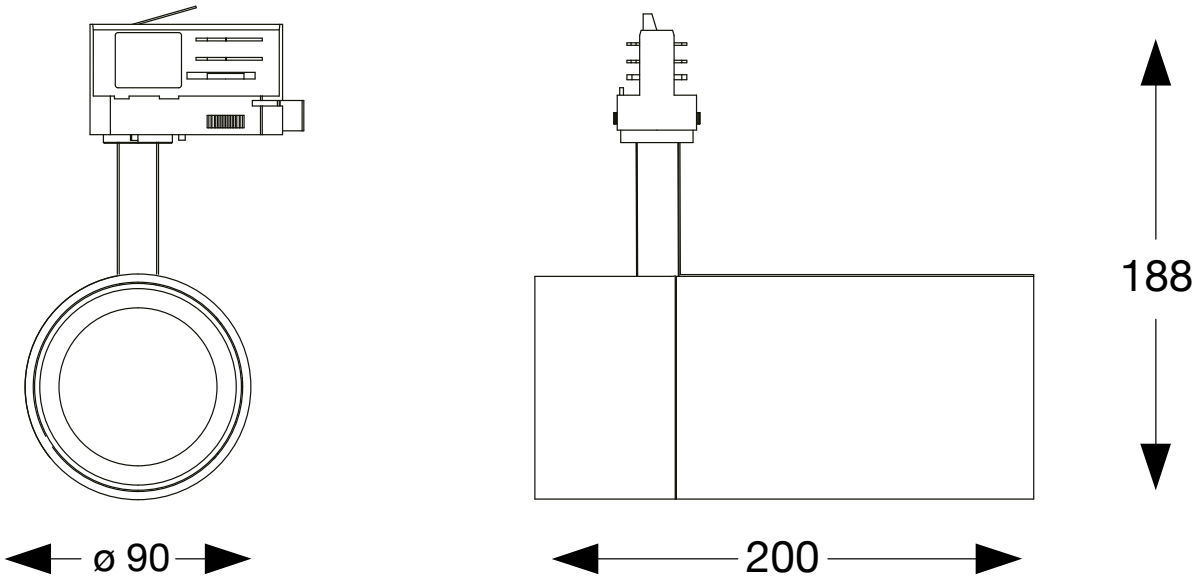

28W

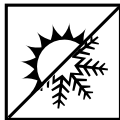

3000 K
3000 K
4000 K
4000 K

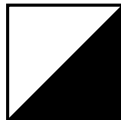

BLACK
WHITE
BLACK
WHITE



222622
222615
222646
222639

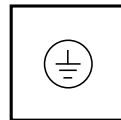

220-240 V



Questo prodotto è fornito con una sorgente luminosa di classe energetica /
This product is provided with a light source with energy class of:

C

IDEAL LUX s.r.l.
Via Taglio Destro 32, 30035 Mirano (VE) Italy
www.ideal-lux.com

ideal lux

Fonte luminosa sostituibile da un
eletttricista qualificato.
Replaceable light-source by a
professional.

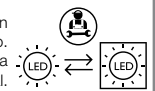

IDEAL LUX Warehouse
Via delle Industrie, 8/D, 30036 Santa Maria di Sala (VE) Italy
8.00 - 12.00 / 13.30 - 17.00

REV 18/08/2021

L'INSTALLAZIONE DI QUESTO APPARECCHIO DEVE ESSERE EFFETTUATA DA PERSONALE QUALIFICATO
THE LIGHTING FITTING SHOULD BE INSTALLED BY A QUALIFIED ELECTRICIAN



I connettori sono nascosti
all'interno
Connectors are hidden inside



1

Assicurarsi che la leva sia posizionata lateralmente in modo che i connettori siano nascosti.
Make sure the lever is positioned sideways so that the connectors are hidden.



2

Inserire i connettori nel binario come illustrato.
Plug the connectors into the track as illustrated.



3

Attenzione, accertarsi del corretto posizionamento dell'articolo durante l'installazione come illustrato nell'immagine.
Warning, make sure to install the item in the correct position as illustrated.

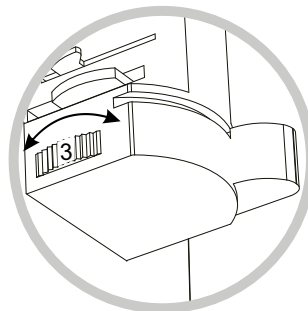
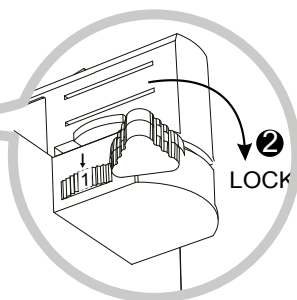

4

Ruotare la leva dei connettori di 90° come illustrato e bloccare il faretto. Selezionare la fase desiderata.
Turn the connectors' lever 90° according to the illustrated direction and lock the light. Select the chosen phase.

