

OFFICE SP

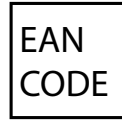
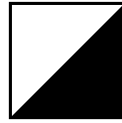
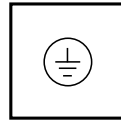
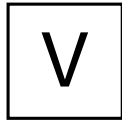
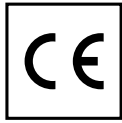

220-240 Vdc

30 W
30 W
30 W
30 W

3000 K BK
3000 K WH
4000 K BK
4000 K WH

271187
271194
271200
271217

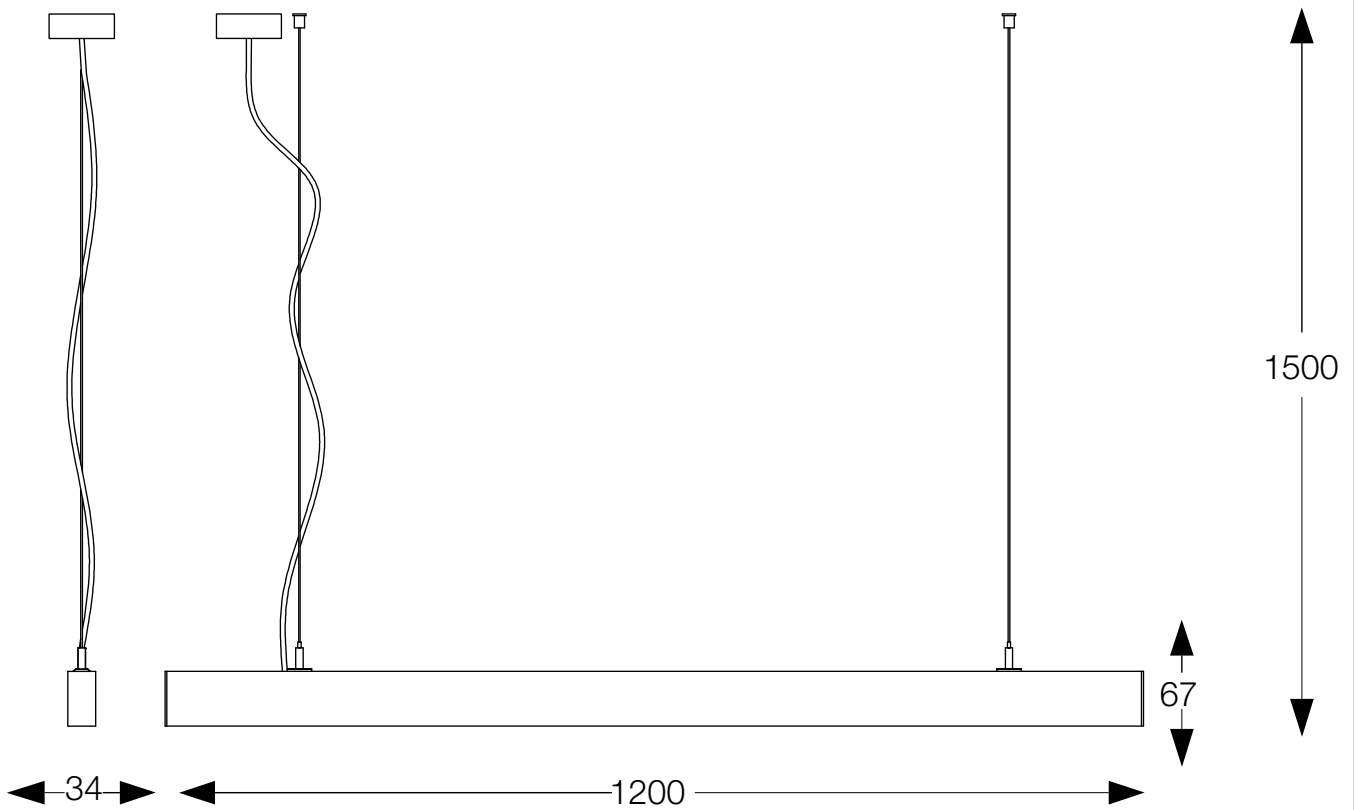

Ideal Lux non è responsabile della sicurezza e del funzionamento del sistema OFFICE. In caso si utilizzino componenti non appartenenti ad esso o qualora le istruzioni di montaggio non vengano rispettate, Ideal Lux is not responsible for the safety and operation of the OFFICE System if the components used are not belonging to the System itself or if the assembly instructions are not respected.

Questo prodotto è fornito con una sorgente luminosa di classe energetica /
This product is provided with a light source with energy class of:

271187 F
271194 F
271200 E
271217 E

IDEAL LUX s.r.l.
Via Taglio Destro 32, 30035 Mirano (VE) Italy
www.ideal-lux.com

ideal lux

Driver sostituibile da un elettricista
qualificato.
Replaceable control gear by a
professional.

Fonte luminosa sostituibile da un
elettricista qualificato.
Replaceable light-source by a
professional.

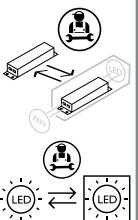

IDEAL LUX Warehouse
Via delle Industrie, 8/D, 30036 Santa Maria di Sala (VE) Italy
8.00 - 12.00 / 13.30 - 17.00

REV 10/08/2021

L'INSTALLAZIONE DI QUESTO APPARECCHIO DEVE ESSERE EFFETTUATA DA PERSONALE QUALIFICATO
THE LIGHTING FITTING SHOULD BE INSTALLED BY A QUALIFIED ELECTRICIAN

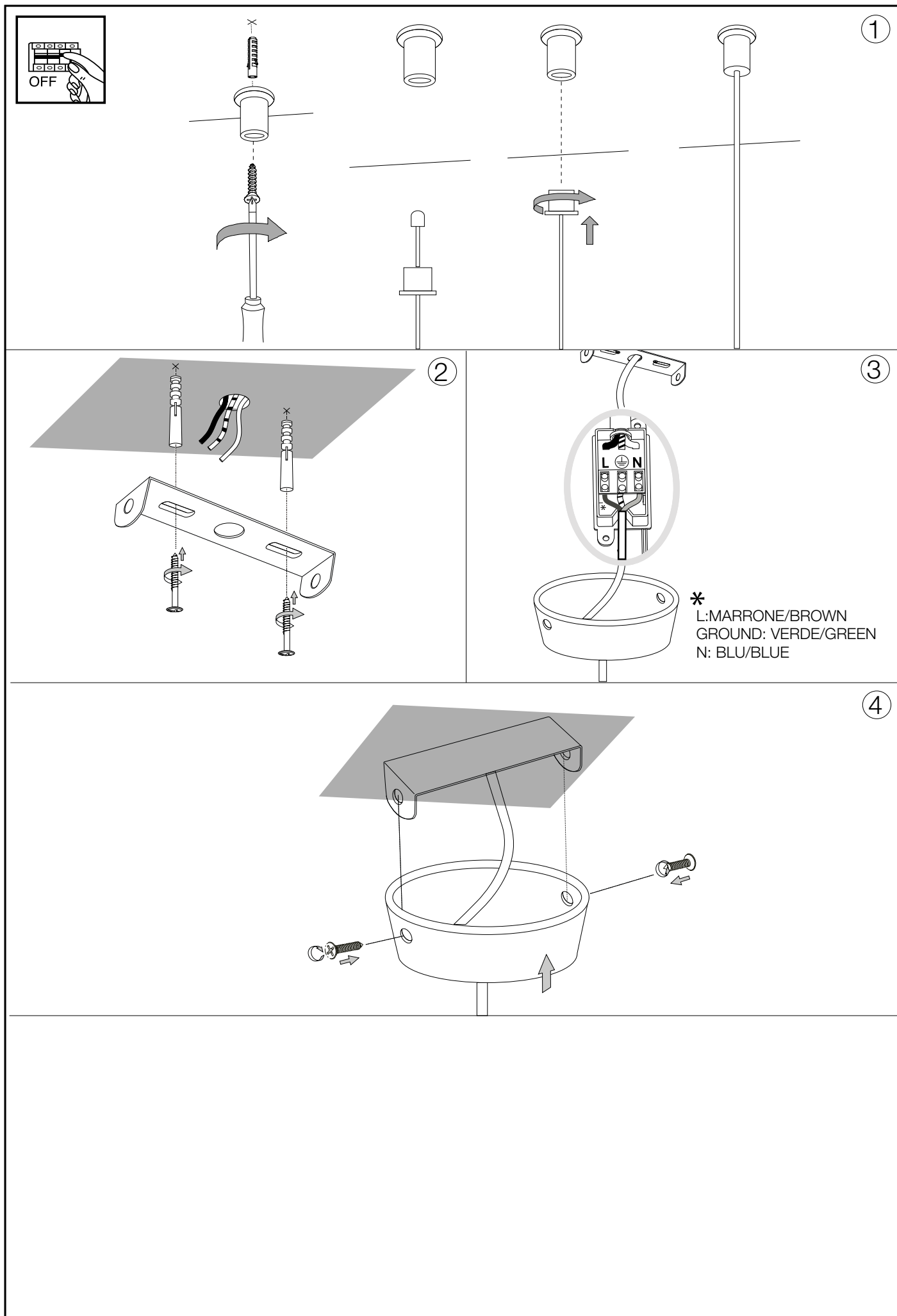

LA SICUREZZA DI QUESTO APPARECCHIO È GARANTITA SOLO CON L'USO APPROPRIATO DI QUESTE ISTRUZIONI, PERTANTO È NECESSARIO CONSERVARLE
THE SAFETY AND RELIABILITY ARE GUARANTEED ONLY WHEN INSTALLATION INSTRUCTIONS ARE PROPERLY FOLLOWED. PLEASE RETAIN THIS INSTRUCTION SHEET FOR FUTURE REFERENCE.

