

Tuburi termocontractabile cu perete subțire - raport de contracție 2:1 **2**

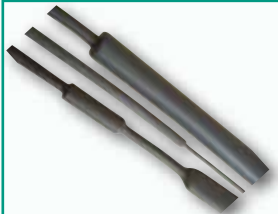

Tuburi termocontractabile cu perete subțire, cu raport de contracție 3:1 **3**



Tuburi termocontractabile cu perete mediu și gros **4**

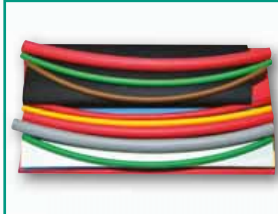

Set hobby de tuburi termocontractabile **4**



Seturi de tuburi termocontractabile **5**

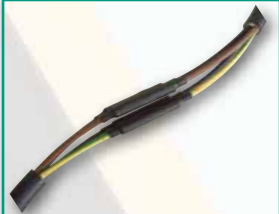

Manșoane 0,6/1 kV pentru cabluri neecranate **6**



Manșoane 0,6/1 kV pentru cabluri ecranate cu țesătură de liță **7**



Manșoane 0,6/1 kV pentru cabluri ecranate cu țesă metalică **8**



Branșamente cu două brațe **9**



Branșamente cu trei ramificații **9**



Branșamente cu patru ramificații **10**



Pistol de aer cald **10**



Branșamente cu cinci ramificații **11**



Seturi de bransamente 0,6/1 kV pentru cabluri neecranate **11**



Seturi de bransamente 0,6/1 kV pentru cabluri ecranate cu țesătură de liță **12**



Seturi de bransamente 0,6/1 kV pentru cabluri ecranate cu țesă metalică **13**



Set manșon în linie, cu rășină **14**



Set manșon derivație cu rășină (tip Y) **15**



Capace termocontractabile **16**



Tuburi termocontractabile cu fermoar pentru reparații. **16**



Tub contractabil la rece **17**

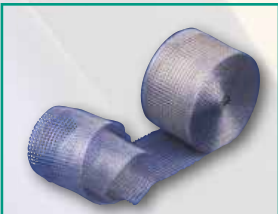

Plasă de cupru ZSSZR5 **18**

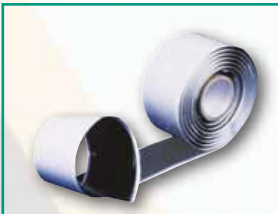

Bandă de etanșare ZSSZOH1,5 **18**



Bandă de umplere ZSSZVM-1 **18**



Arc de pământare **18**



## Pictogramele capului de tabel

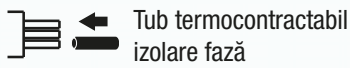

Tub termocontractibil  
izolare fază



Tub exterior



Cablu principal



Cablu de ramificație



Timp de întărire



Volum



Absorbția de apă timp  
de 42 de zile la 50 °C



Secțiunea  
conductorului de  
racord

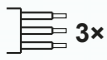

Cablu cu 3  
conductoare



Masa

## Pictogramele datelor tehnice



Raport de contracție



Temperatura mediului  
ambiant



Temperatura de  
depozitare



Temperatura de  
contracție



Lungime



Material: Poliolefină



Nu conține elemente  
halogen



Rezistent UV



Material: Polietilenă



Rezistență la foc  
conform UL 94



Rigiditatea dielectrică



Conținutul setului



Fără silicon



Rezistent la apă



Material: Cauciuc  
siliconic

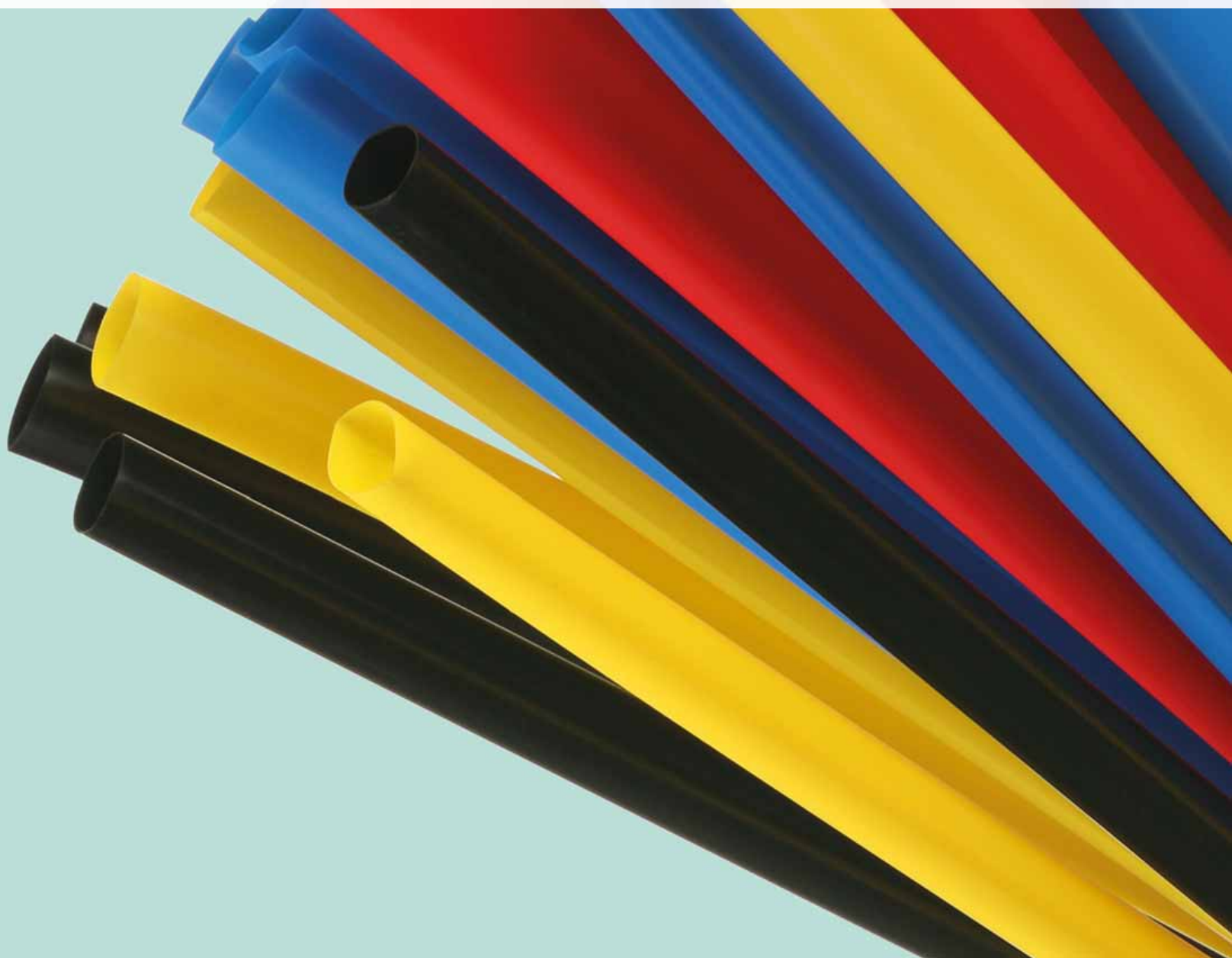

## Tuburi termocontractibile cu perete subțire - raport de contracție 2:1



TRACON											D <sub>1</sub>	D <sub>2</sub>	S
											(mm)	(mm)	(mm)
ZS016	ZS016SZ	-	ZS016K	-	ZS016P	ZS016S	ZS016Z	ZS016FEH	-	ZS016LIL	1.6	0.8	0.45
ZS024	ZS024SZ	ZS024B	ZS024K	ZS024ZS	ZS024P	ZS024S	ZS024Z	ZS024FEH	ZS024N	ZS024LIL	2.4	1.2	0.43
ZS032	ZS032SZ	ZS032B	ZS032K	ZS032ZS	ZS032P	ZS032S	ZS032Z	ZS032FEH	ZS032N	ZS032LIL	3.2	1.6	0.43
ZS048	ZS048SZ	ZS048B	ZS048K	ZS048ZS	ZS048P	ZS048S	ZS048Z	ZS048FEH	ZS048N	ZS048LIL	4.8	2.4	0.43
ZS064	ZS064SZ	ZS064B	ZS064K	ZS064ZS	ZS064P	ZS064S	ZS064Z	ZS064FEH	ZS064N	ZS064LIL	6.4	3.2	0.56
ZS095	ZS095SZ	ZS095B	ZS095K	ZS095ZS	ZS095P	ZS095S	ZS095Z	ZS095FEH	ZS095N	ZS095LIL	9.5	4.8	0.56
ZS127	ZS127SZ	ZS127B	ZS127K	ZS127ZS	ZS127P	ZS127S	ZS127Z	ZS127FEH	ZS127N	ZS127LIL	12.7	6.4	0.56
ZS190	ZS190SZ	ZS190B	ZS190K	ZS190ZS	ZS190P	ZS190S	ZS190Z	ZS190FEH	ZS190N	ZS190LIL	19	9.5	0.7
ZS254	ZS254SZ	ZS254B	ZS254K	ZS254ZS	ZS254P	ZS254S	ZS254Z	ZS254FEH	ZS254N	ZS254LIL	25.4	12.7	0.76
ZS381	ZS381SZ	ZS381B	ZS381K	ZS381ZS	ZS381P	ZS381S	ZS381Z	ZS381FEH	ZS381N	ZS381LIL	38.1	19	0.86
ZS508	ZS508SZ	ZS508B	ZS508K	ZS508ZS	ZS508P	ZS508S	ZS508Z	ZS508FEH	ZS508N	-	50.8	25.4	0.96
ZS760	-	-	-	-	-	-	-	-	-	-	76.2	38.1	1.2
ZS1020	ZS1020SZ	-	-	-	ZS1020P	ZS1020S	ZS1020Z	-	-	-	101.6	50.8	1.15

Dacă comandați role, adăugați codului litera -D, de ex. ZS016-D.

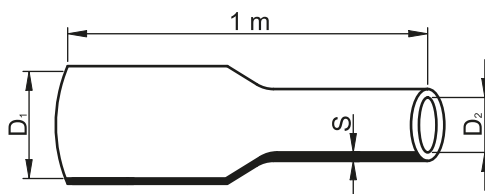
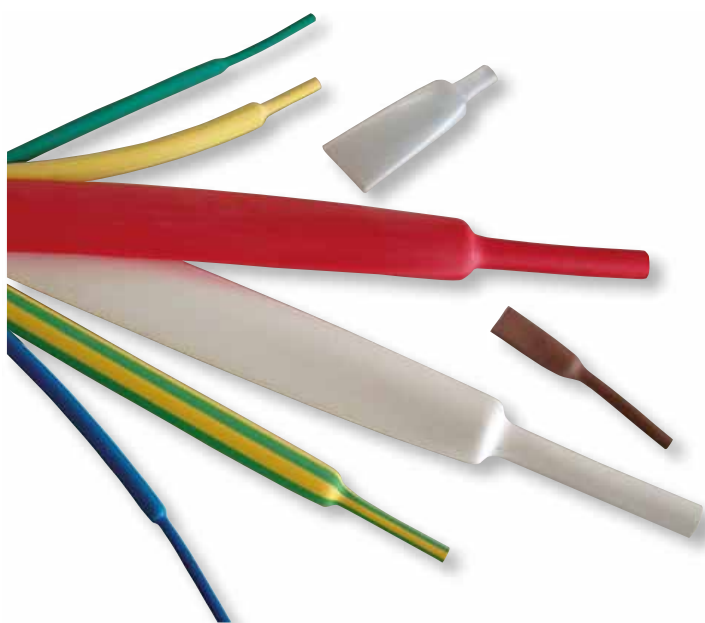

D1 – diametru interior înainte de contracție  
 D2 – diametru interior după contracție liberă  
 S – Grosimea peretelui după contracție liberă

**RELEVANT STANDARD  
 EN 60684**

**UL CERTIFICATE NO.  
 YDPU2.E204071**

**TÜV MEEI TEST DOCUMENTATION  
 K-08382**



### Domenii de utilizare

- Izolarea electrică a cablurilor și conductorilor
- Refacerea izolației conductorilor
- Protecție anticorozivă a cablurilor și conductorilor
- Protecție la umiditate și condiții meteo nefavorabile a cablurilor și conductorilor
- Izolarea papucilor electrici
- Protecția componentelor electronice
- Protecție anticorozivă a barelor metalice sau a mânerelor de unelte
- Scop decorativ

## Tuburi termocontractabile cu perete subțire, cu raport de contracție 3:1

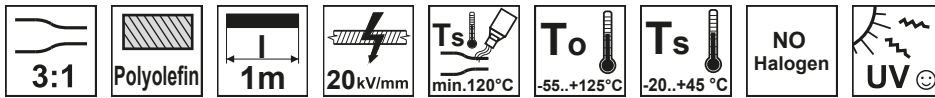

Fără adeziv

TRACON	$D_1$ (mm)	$D_2$ (mm)	S (mm)
ZSV30	3	1	0.55
ZSV48	4.8	1.6	0.60
ZSV60	6	2	0.65
ZSV90	9	3	0.75
ZSV120	12	4	0.75
ZSV180	19	6	0.95
ZSV240	24	8	1.15
ZSV390	39	13	1.30

Cu adeziv

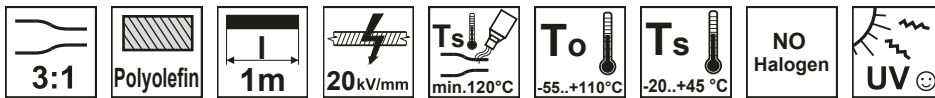

TRACON	$D_1$ (mm)	$D_2$ (mm)	S (mm)
ZSVR30	3	1	1
ZSVR48	4.8	1.6	1
ZSVR60	6	2	1
ZSVR90	9	3	1.4
ZSVR120	12	4	1.6
ZSVR190	19	6	2.15
ZSVR240	24	8	2.4
ZSVR390	39	13	2.4



RELEVANT STANDARD  
EN 60684

TÜV MEEI TEST DOCUMENTATION  
K-08382

UL CERTIFICATE NO.  
YDPU2.E204071

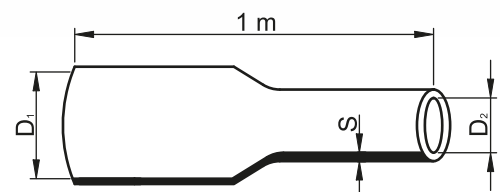

**Tuburi termocontractabile cu perete mediu și gros, cu adeziv**

**Cu perete mediu**



TRACON	D <sub>1</sub> (mm)	D <sub>2</sub> (mm)	S (mm)
ZS8/2R	8	2	1.7
ZS12/3R	12	3	1.5
ZS16/4R	16	4	2
ZS19/6R	19	6	2.5
ZS30/8R	30	8	2.5
ZS40/12R	40	12	3
ZS50/16R	50	16	3
ZS63/19R	63	19	3.5
ZS75/22R	75	22	3.5
ZS95/30R	95	30	4
ZS115/34R	115	34	4
ZS140/42R	140	42	5.5
ZS175/55R	175	55	4

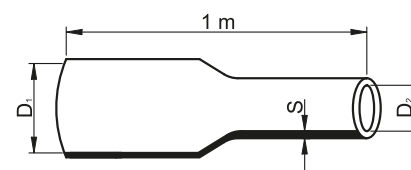

UL CERTIFICATE NO.  
**YDPU2.E204071**

TÜV MEEI TEST DOCUMENTATION  
**K-08382**

RELEVANT STANDARD  
**EN 60684**

**Cu perete gros**

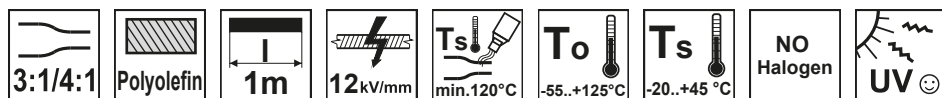

TRACON	D <sub>1</sub> (mm)	D <sub>2</sub> (mm)	S (mm)
ZSB33/8R	33	8	3.2
ZSB51/16R	51	16	6
ZSB85/25R	85	25	6.5
ZSB130/36R	130	36	6.5
ZSB180/50R	180	50	4.3

**ZSB-SET – Set hobby de tuburi termocontractabile**

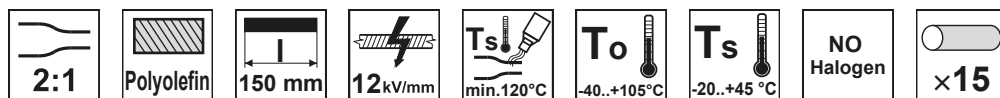

**ZSB-SET**

TRACON	X	
ZSB-SET	15 × 150 mm	
ZSBB-SET	15 × 150 mm	



**ZSBB-SET**

Se poate utiliza pentru repararea izolației conductoarelor.

- Conținutul setului: 15 buc. tuburi termocontractabile cu perete subțire
- Material: poliolefină care nu conține elemente de halogen, raport de contracție 2:1
- Dimensiuni: Bucăți cu lungimea de 150mm, care au diferite dimensiuni

RELEVANT STANDARD  
**EN 60684**

**Legendă pictograme** **D/O**

**Seturi de tuburi termocontractabile, cu adeziv**



NYJ-J, NYJ-O, NAYJ-J,  
NAYJ-O, NA2XY-J, NA2XY-O, NA2X2Y-J,  
NA2X2Y-O, SZRMEKM, SZAMEKM

TRACON	mm <sup>2</sup>	Cabluri			Mufe		
		d <sub>1</sub> /d <sub>2</sub> (mm)	l (mm)	×	D <sub>1</sub> /D <sub>2</sub> (mm)	L (mm)	×
ZSRSET3-1,5	3 × 1.5	8/2	50	3	19/6	200	1
ZSRSET3-2,5	3 × 2.5	8/2	50	3	19/6	250	1
ZSRSET4-1,5	4 × 1.5	8/2	50	4	19/6	200	1
ZSRSET4-2,5	4 × 2.5	8/2	50	4	19/6	250	1
ZSRSET4-4	4 × 4	8/2	100	4	30/8	250	1
ZSRSET4-6	4 × 6	8/2	100	4	30/8	330	1
ZSRSET4-10	4 × 10	12/3	100	4	40/12	500	1
ZSRSET4-16	4 × 16	12/3	200	4	40/12	500	1
ZSRSET4-25	4 × 25	19/6	200	4	50/16	500	1
ZSRSET4-35	4 × 35	19/6	200	4	50/16	1000	1
ZSRSET4-50	4 × 50	19/6	200	4	63/19	1000	1
ZSRSET4-70	4 × 70	30/8	250	4	63/19	1000	1
ZSRSET4-95	4 × 95	30/8	250	4	75/22	1000	1
ZSRSET4-120	4 × 120	30/8	250	4	95/30	1000	1
ZSRSET4-150	4 × 150	40/12	250	4	95/30	1000	1
ZSRSET4-185	4 × 185	40/12	250	4	115/34	1000	1
ZSRSET4-240	4 × 240	40/12	330	4	115/34	1000	1
ZSRSET5-1,5	5 × 1.5	8/2	50	5	19/6	200	1
ZSRSET5-2,5	5 × 2.5	8/2	50	5	19/6	250	1
ZSRSET5-4	5 × 4	8/2	100	5	30/8	250	1
ZSRSET5-6	5 × 6	8/2	100	5	30/8	330	1
ZSRSET5-10	5 × 10	12/3	100	5	40/12	500	1
ZSRSET5-16	5 × 16	12/3	200	5	40/12	500	1
ZSRSET5-25	5 × 25	19/6	200	5	50/16	500	1
ZSRSET5-35	5 × 35	19/6	200	5	50/16	1000	1
ZSRSET5-50	5 × 50	19/6	200	5	63/19	1000	1
ZSRSET5-70	5 × 70	30/8	250	5	63/19	1000	1

Pe baza tipului și secțiunii cablurilor care se manșonează trebuie alese mufele de legătură din Cu respectiv Al. (Setul nu conține aceste mufe).

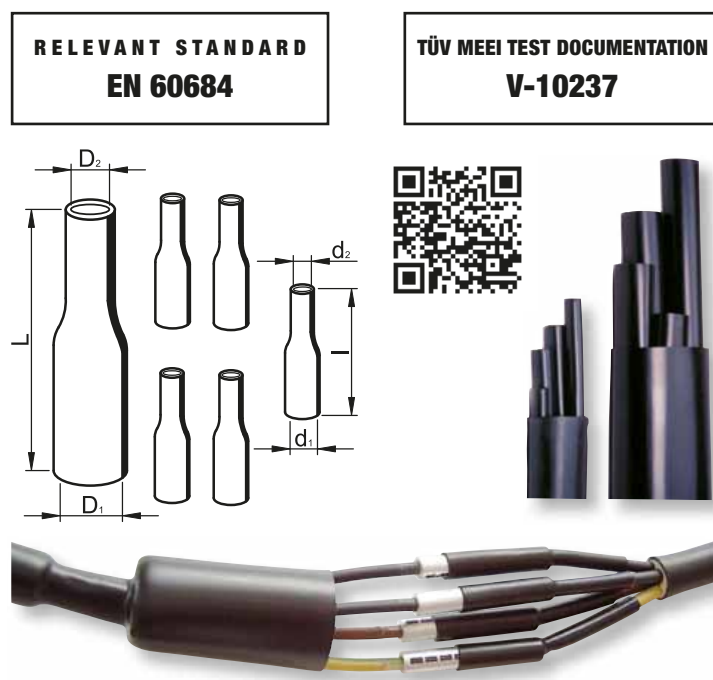

## Seturi de tuburi termocontractabile (manșoane) 0,6/1 kV pentru cabluri neecranate

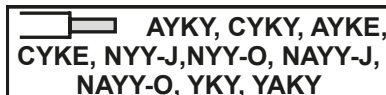

### Variante constructive cu tub termocontractabil exterior cu perete mediu

TRACON	mm <sup>2</sup>	d <sub>1</sub> /d <sub>2</sub> (mm)	l (mm)	×	D <sub>1</sub> /D <sub>2</sub> (mm)	L (mm)	×
ZSRSET-1	4 × 6 – 4 × 25	12/3	100	4	40/12	500	1
ZSRSET-2A	4 × 25 – 4 × 35	19/6	200	4	50/16	1000	1
ZSRSET-2B	4 × 50 – 4 × 70	30/8	200	4	63/19	1000	1
ZSRSET-2	4 × 35 – 4 × 120	30/8	200	4	75/22	1000	1
ZSRSET-3	4 × 150 – 4 × 240	40/12	250	4	140/42	1000	1
ZSRSET5-1	5 × 6 – 5 × 25	12/3	100	5	40/12	500	1
ZSRSET5-2A	5 × 25 – 5 × 35	19/6	200	5	50/16	1000	1
ZSRSET5-2B	5 × 50 – 5 × 70	30/8	200	5	63/19	1000	1
ZSRSET5-2	5 × 35 – 5 × 120	30/8	200	5	75/22	1000	1
ZSRSET5-3	5 × 150 – 5 × 240	40/12	250	5	140/42	1000	1

### Variante constructive cu tub termocontractabil exterior cu perete gros

TRACON	mm <sup>2</sup>	d <sub>1</sub> /d <sub>2</sub> (mm)	l (mm)	×	D <sub>1</sub> /D <sub>2</sub> (mm)	L (mm)	×
ZSRSET-1FK	4 × 6 – 4 × 25	19/6	150	4	51/16	500	1
ZSRSET-2FK	4 × 35 – 4 × 120	30/8	200	4	85/25	1000	1
ZSRSET-3FK	4 × 150 – 4 × 240	50/16	300	4	130/36	1000	1
ZSRSET5-1FK	5 × 6 – 5 × 25	19/6	150	5	51/16	500	1
ZSRSET5-2FK	5 × 35 – 5 × 120	30/8	200	5	85/25	1000	1
ZSRSET5-3FK	5 × 150 – 5 × 240	50/16	300	5	130/36	1000	1

Setul nu conține mufe; mufele de cupru sau de aluminiu se aleg în funcție de conductorii ce se conectează

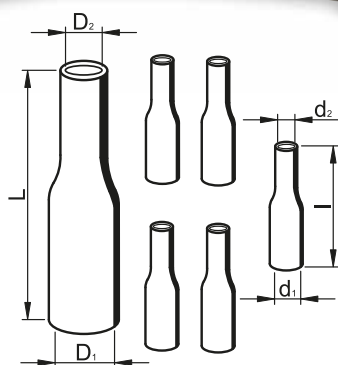

#### Conținutul setului:

- Instrucțiuni de montare 1 buc
- Tub de exterior termocontractabil cu perete gros sau mediu, cu adeziv 1 buc
- Tub de fază termocontractabil cu perete mediu, cu adeziv 4 sau 5 buc

d<sub>1</sub> – diametru interior tub fază înainte de contracție  
 d<sub>2</sub> – diametru interior tub fază după contracție liberă  
 D<sub>1</sub> – diametru interior tub exterior înainte de contracție  
 D<sub>2</sub> – diametru interior tub exterior după contracție liberă

RELEVANT STANDARD  
**EN 60684**

TŪV MEEI TEST DOCUMENTATION  
**V-10237**



### CITIȚI CODUL !

- Vezi noutățile noastre
- Fiți informat

Gama de produse se dezvoltă continuu și rapid!  
 Catalogul nostru reflectă situația din Aprilie 2021.  
 Pentru informații actualizate vizitați pagina noastră de internet!

## Manșoane 0,6/1 kV pentru cabluri ecranate cu țesătură de liță

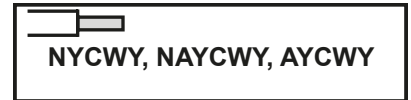

### Tuburi de fază și de exterior

TRACON	mm <sup>2</sup>	d <sub>1</sub> /d <sub>2</sub> (mm)	l (mm)	×	D <sub>1</sub> /D <sub>2</sub> (mm)	L (mm)	×
ZSRSET-1DA	4 × 6 – 4 × 25	19/6	150	4	51/16	500	1
ZSRSET-2DA	4 × 35 – 4 × 120	30/8	200	4	85/25	1000	1
ZSRSET-3DA	4 × 150 – 4 × 240	50/16	300	4	130/36	1000	1

### Elemente de refacerea ecranării

TRACON	Secțiune conductor (mm <sup>2</sup> )	Ecranare		Umplere		Altele
		Secțiune mufă (mm <sup>2</sup> )	Cantitate	Dimensiune bandă de umplere (mm)	Număr role	Dimensiune bandă abrazivă
ZSRSET-1DA	4 × 6 – 4 × 25	10	1	0.4 × 50 × 5000	1	600 mm × 25 mm
ZSRSET-2DA	4 × 35 – 4 × 120	25-35	2-2	0.4 × 50 × 5000	1	600 mm × 25 mm
ZSRSET-3DA	5 × 150 – 5 × 240	50	1	0.4 × 50 × 5000	1	800 mm × 25 mm

Setul nu conține mufe; mufele de cupru sau de aluminiu se aleg în funcție de conductorii ce se conectează

### Conținutul setului:

- 1 buc. tub exterior cu perete gros și material termoadeziv ①
- 4 buc. tuburi de fază cu perete mediu și cu material termoadeziv ②
- 1 (2) buc. mufă de cupru pentru refacerea ecranării ③
- 1 rolă de material umplere ④
- 1 buc. bandă abrazivă ⑤

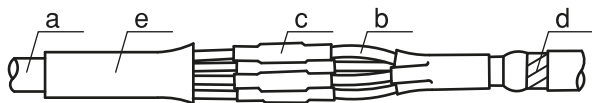

- a cablu ecranat de joasă tensiune
- b conductor
- c tub de fază
- d ecranare
- e tub exterior de refacerea mantalei;

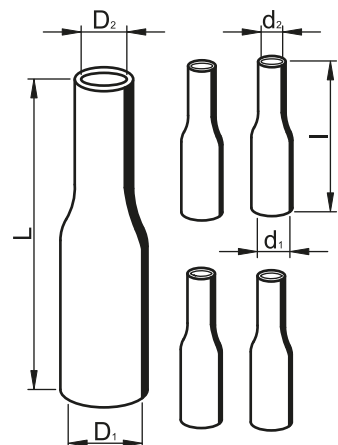

d<sub>1</sub> – diametru interior tub fază înainte de contracție  
 d<sub>2</sub> – diametru interior tub fază după contracție liberă  
 D<sub>1</sub> – diametru interior tub exterior înainte de contracție  
 D<sub>2</sub> – diametru interior tub exterior după contracție liberă

### Mufe neizolate



**A/10-A/11**

RELEVANT STANDARD  
**EN 60684**

TÜV MEEI TEST DOCUMENTATION  
**V-10237**



### Manșoane 0,6/1 kV pentru cabluri ecranate cu tresă metalică



#### Tuburi de fază respectiv de exterior

TRACON	mm <sup>2</sup>	d <sub>1</sub> /d <sub>2</sub> (mm)	l (mm)	X	D <sub>1</sub> /D <sub>2</sub> (mm)	L (mm)	X
ZSRSET-1DB	4 × 6 – 4 × 25	19/6	150	4	51/16	500	1
ZSRSET-2DB	4 × 35 – 4 × 120	30/8	200	4	85/25	1000	1
ZSRSET-3DB	4 × 150 – 4 × 240	50/16	300	4	130/36	1000	1

#### Elemente de facerea ecranării

TRACON	Secțiune conductor (mm <sup>2</sup> )	Ecranare		Umplere		Altele
		Arc de pământare	Tresă din CU stanat	Dimensiune bandă de umplere (mm)	Număr role	Dimensiune bandă abrazivă
ZSRSET-1DB	4 × 6 – 4 × 25	4 buc. TRF1	0.5 m	0.4 × 50 × 5000	1	600 mm × 25 mm
ZSRSET-2DB	4 × 35 – 4 × 120	4 buc. TRF2	0.7 m	0.4 × 50 × 5000	1	600 mm × 25 mm
ZSRSET-3DB	4 × 150 – 4 × 240	4 buc. TRF5	2 × 0.8 m	0.4 × 50 × 5000	1	800 mm × 25 mm

Setul nu conține mufe; mufele de cupru sau de aluminiu se aleg în funcție de conductorii ce se conectează



Legendă pictograme

D/O

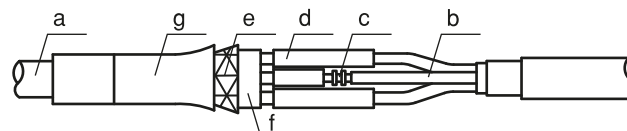

- a cablu ecranat cu tresă metalică de joasă tensiune cu 4 conductori
- b conductor
- c mufă de conexiune
- d tub de fază
- e ecranare cu tresă metalică
- f arc pentru pământare
- g tub exterior de refacerea mantalei

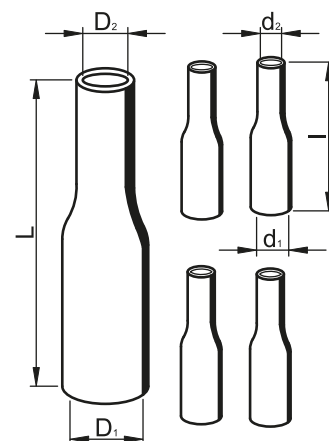

#### Conținutul setului:

- 1 buc. tub exterior cu perete gros și material termoadeziv ①
- 4 buc. tuburi de fază cu perete mediu și cu material termoadeziv ②
- 1 buc. tresă metalică ③
- 4 buc. arc de pentru pământare ④
- 1 rolă de material umplere ⑤
- 1 buc. bandă abrazivă ⑥

RELEVANT STANDARD  
EN 60684

TÜV MEEI TEST DOCUMENTATION  
V-10237

- d<sub>1</sub> – diametru interior tub fază înainte de contracție
- d<sub>2</sub> – diametru interior tub fază după contracție liberă
- D<sub>1</sub> – diametru interior tub exterior înainte de contracție
- D<sub>2</sub> – diametru interior tub exterior după contracție liberă

## Branșamente cu două brațe



TRACON	mm <sup>2</sup>	D <sub>max</sub> (mm)	D <sub>min</sub> (mm)	d <sub>max</sub> (mm)	d <sub>min</sub> (mm)	S (mm)	S* (mm)	L (mm)	L* (mm)
<b>V23012</b>	2 × 4 – 2 × 35	30	9	15	4	1	2	83	88

D<sub>max</sub>, d<sub>max</sub> – diametre interioare înainte de contracție  
 D<sub>min</sub>, d<sub>min</sub> – diametre interioare după contracție liberă  
 S – grosime perete tub înainte de contracție  
 S\* – grosime perete tub după contracție liberă

L – lungime totală înainte de contracție  
 L\* – lungime totală după contracție liberă

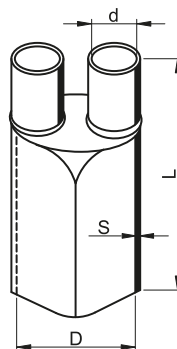

## Branșamente cu trei ramificații

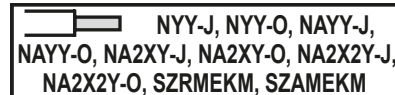

TRACON	mm <sup>2</sup>	D <sub>max</sub> (mm)	D <sub>min</sub> (mm)	d <sub>max</sub> (mm)	d <sub>min</sub> (mm)	S (mm)	S* (mm)	L (mm)	L* (mm)
<b>VE3259</b>	3 × 2.5 – 3 × 10	25	9	9	3	2.5	1.8	50	70
<b>VE33816</b>	3 × 10 – 3 × 50	38	17	14	4,5	2,7	2,7	98	97
<b>VE38036</b>	3 × 70 – 3 × 240	80	38	35	11	2,8	3,5	185	195

D<sub>max</sub>, d<sub>max</sub> – diametre interioare înainte de contracție  
 D<sub>min</sub>, d<sub>min</sub> – diametre interioare după contracție liberă  
 S – grosime perete tub înainte de contracție  
 S\* – grosime perete tub după contracție liberă

L – lungime totală înainte de contracție  
 L\* – lungime totală după contracție liberă



TÜV MEEI TEST DOCUMENTATION  
**K-08382**

RELEVANT STANDARD  
**EN 60684**

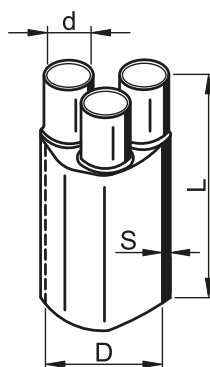

### Branșamente cu patru ramificații



NY-Y-J, NY-Y-O, NAYY-J,  
NAYY-O, NA2XY-J, NA2XY-O, NA2X2Y-J,  
NA2X2Y-O, SZRMEKM, SZAMEKM

TRACON	mm <sup>2</sup>	D <sub>max</sub> (mm)	D <sub>min</sub> (mm)	d <sub>max</sub> (mm)	d <sub>min</sub> (mm)	S (mm)	S* (mm)	L (mm)	L* (mm)
VE3512	4 × 6 – 4 × 25	35	14	13,5	4	1,5	2,2	80	95,3
VE3512C	4 × 6 – 4 × 25	42	15	13	5	1,6	2,5	95	103
VE4021	4 × 35 – 4 × 50	58	21	24,5	7	2,6	3,1	131	165
VE4021C	4 × 35 – 4 × 50	52	20	19	5,5	2,3	3,2	145	148
VE5527	4 × 70 – 4 × 120	70	24,5	24,5	7	2,9	5	150	185
VE5527C	4 × 70 – 4 × 120	74	25	27	8	2	3,4	180	177
VE8035	4 × 120 – 4 × 240	90	37	35	15	3	4	170	210
VE8035C	4 × 120 – 4 × 240	85	39	34	12,5	2,5	3,5	170	185
VE10045	4 × 150 – 4 × 300	102	47	38	12	3	4	185	195
VE12550	4 × 300	130	52	52	15	4	4	210	230

D<sub>max</sub>, d<sub>max</sub> – diametre interioare înainte de contracție  
D<sub>min</sub>, d<sub>min</sub> – diametre interioare după contracție liberă  
S – grosime perete tub înainte de contracție  
S\* – grosime perete tub după contracție liberă

L – lungime totală înainte de contracție  
L\* – lungime totală după contracție liberă

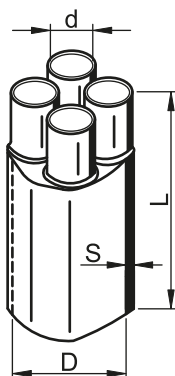

### Pistol de aer cald

TRACON	U <sub>n</sub>	[W]	°C	m	l/min.
HLF-02	230 V AC	1.000/2.000 W	350/600 °C	1450 g	300 / 500 l/min.

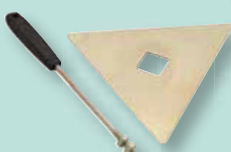

B/19

## Branșamente cu cinci ramificații

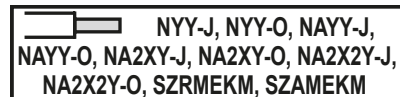
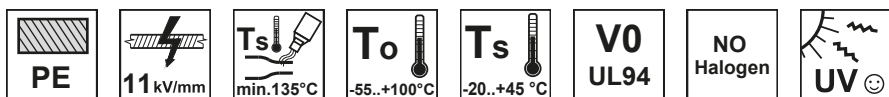

TRACON	mm <sup>2</sup>	D <sub>max</sub> (mm)	D <sub>min</sub> (mm)	d <sub>max</sub> (mm)	d <sub>min</sub> (mm)	S (mm)	S* (mm)	L (mm)	L* (mm)
VE54019	5 × 16 – 5 × 35	40	19	13	4	2	2.5	105	98
VE55524	5 × 35 – 5 × 70	55	24	18	5	2	3.2	160	155
VE58033	5 × 70 – 5 × 120	80	33	16	8	2.1	3	155	180
VE510046	5 × 150 – 5 × 240	98	49	34.5	11	2.4	3.5	190	200

D<sub>max</sub>, d<sub>max</sub> – diametre interioare înainte de contracție  
 D<sub>min</sub>, d<sub>min</sub> – diametre interioare după contracție liberă  
 S – grosime perete tub înainte de contracție

S\* – grosime perete tub după contracție liberă  
 L – lungime totală înainte de contracție  
 L\* – lungime totală după contracție liberă

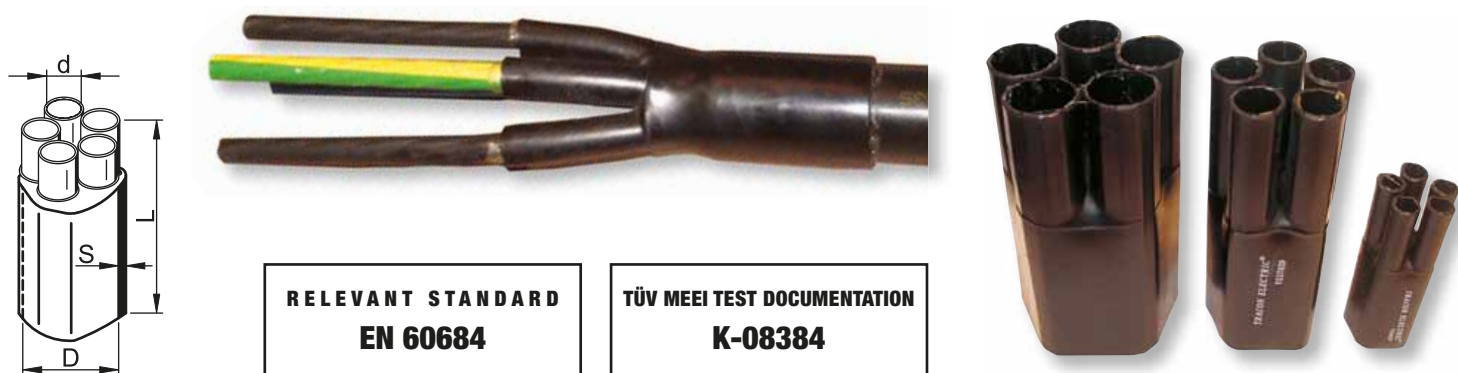

## Seturi de branșamente 0,6/1 kV pentru cabluri neecranate

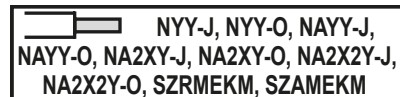
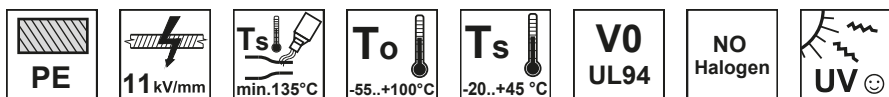

TRACON	Secțiune conductor (mm <sup>2</sup> )	Ramificație (1)		Tuburi de fază (2)		
		Tip	Cantitate	D <sub>1</sub> /D <sub>2</sub> (mm)	L (m)	Cantitate
VE3512-SZ	4 × 6 – 4 × 25	VE3512	1	12.7/6.4	3	1
VE4021-SZ	4 × 35 – 4 × 50	VE4021	1	19/9.5	4	1
VE5527-SZ	4 × 70 – 4 × 120	VE5527	1	25.4/12.7	5	1
VE8035-SZ	4 × 150 – 4 × 240	VE8035	1	38.1/19	8	1

Papucii de cupru sau aluminiu se aleg în funcție de secțiunea conductoarelor (nu fac parte din set)

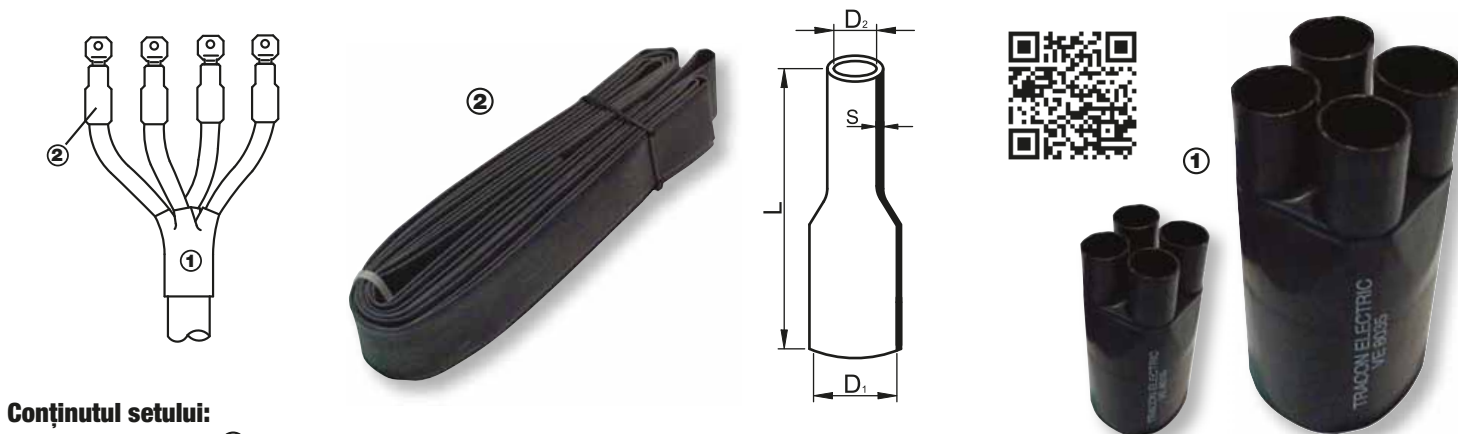

### Conținutul setului:

- Tub patru ramificații ①
- Tub de fază cu perete subțire rezistentă UV ②
- Tubul de fază contractat pe izolația conductorilor asigură protecție la umezeală.

### Seturi de branșamente 0,6/1 kV pentru cabluri ecranate cu țesătură de liță



NYCWY, NAYCWY, AYCWY

#### Tuburi de fază și de ramificație

TRACON	Tip	Secțiune conductor (mm <sup>2</sup> )	Tub ramificație		Tub izolare papuc			Tub izolare completă fază		
			Varianta	Cantitate	D <sub>1</sub> /D <sub>2</sub> (mm)	l (mm)	Cantitate	D <sub>1</sub> /D <sub>2</sub> (mm)	L (m)	Cantitate
ZSVRS-1B1	Interior	4 × 6 – 4 × 25	VE3512	1	19/6	50	4	-	-	-
ZSVRS-1K1	Exterior	4 × 6 – 4 × 25	VE3512	1	19/6	50	4	12.7/6.4	2	1
ZSVRS-2B1	Interior	4 × 35 – 4 × 50	VE4021	1	30/8	50	4	-	-	-
ZSVRS-2K1	Exterior	4 × 35 – 4 × 50	VE4021	1	30/8	50	4	19/9.5	3	1
ZSVRS-3B1	Interior	4 × 70 – 4 × 120	VE5527	1	40/12	80	4	-	-	-
ZSVRS-3K1	Exterior	4 × 70 – 4 × 120	VE5527	1	40/12	80	4	25.4/12.7	4	1
ZSVRS-4B1	Interior	4 × 150 – 4 × 240	VE8035	1	50/16	100	4	-	-	-
ZSVRS-4K1	Exterior	4 × 150 – 4 × 240	VE8035	1	50/16	100	4	38.1/19	8	1

#### Componente de refacerea ecranării

TRACON	Secțiune conductor (mm <sup>2</sup> )	Umplere		Altele
		Tip bandă de etanșare	Lungime (m)	Dimensiune bandă abrazivă
ZSVRS-1B1	4 × 6 – 4 × 25	ZSSZOH1,5	1.5	600 mm × 25 mm
ZSVRS-1K1	4 × 6 – 4 × 25	ZSSZOH1,5	1.5	600 mm × 25 mm
ZSVRS-2B1	4 × 35 – 4 × 50	ZSSZOH1,5	1.5	600 mm × 25 mm
ZSVRS-2K1	4 × 35 – 4 × 50	ZSSZOH1,5	1.5	600 mm × 25 mm
ZSVRS-3B1	4 × 70 – 4 × 120	ZSSZOH1,5	1.5	600 mm × 25 mm
ZSVRS-3K1	4 × 70 – 4 × 120	ZSSZOH1,5	1.5	600 mm × 25 mm
ZSVRS-4B1	4 × 150 – 4 × 240	ZSSZOH1,5	1.5	800 mm × 25 mm
ZSVRS-4K1	4 × 150 – 4 × 240	ZSSZOH1,5	1.5	800 mm × 25 mm

Papucii de cupru sau aluminiu se aleg în funcție de secțiunea conductoarelor (nu fac parte din set)



D<sub>1</sub>, d<sub>1</sub> – diametru înainte de contracție  
D<sub>2</sub>, d<sub>2</sub> – diametru după contracție liberă

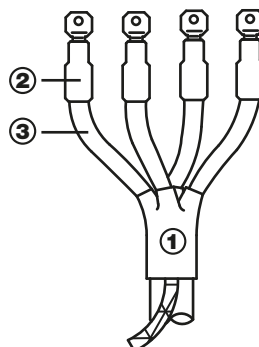
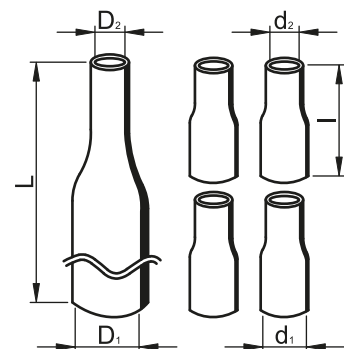

#### Conținutul setului:

- 1 buc. Tub cu patru ramificații ①
- 4 buc. Tuburi de izolare papuci ②
- 1 buc. Tub de izolare fază, cu perete subțire, rezistent la raze UV (numai pentru exterior) ③
- 1 buc. Bandă abrazivă ④
- 1 buc. Bandă de etanșare de tip ZSSZOH1,5; ⑤

RELEVANT STANDARD  
**EN 60684**

TÜV MEEI TEST DOCUMENTATION  
**V-10238**

## Seturi de branșamente 0,6/1 kV pentru cabluri ecranate cu tresă metalică



### Tuburi de fază și de ramificație

TRACON	Varianta	Secțiune conductor (mm <sup>2</sup> )	Tub ramificație		Tub izolare papuc			Tub izolare completă fază		
			Tip	Cantitate	D <sub>1</sub> /D <sub>2</sub> (mm)	l (mm)	Cantitate	D <sub>1</sub> /D <sub>2</sub> (mm)	L (m)	Cantitate
ZSVRS-1B2	Interior	4 × 6 – 4 × 25	VE3512	1	19/6	50	4	-	-	-
ZSVRS-1K2	Exterior	4 × 6 – 4 × 25	VE3512	1	19/6	50	4	12.7/6.4	2	1
ZSVRS-2B2	Interior	4 × 35 – 4 × 50	VE4021	1	30/8	50	4	-	-	-
ZSVRS-2K2	Exterior	4 × 35 – 4 × 50	VE4021	1	30/8	50	4	19/9.5	3	1
ZSVRS-3B2	Interior	4 × 70 – 4 × 120	VE5527	1	40/12	80	4	-	-	-
ZSVRS-3K2	Exterior	4 × 70 – 4 × 120	VE5527	1	40/12	80	4	25.4/12.7	4	1
ZSVRS-4B2	Interior	4 × 150 – 4 × 240	VE8035	1	50/16	100	4	-	-	-
ZSVRS-4K2	Exterior	4 × 150 – 4 × 240	VE8035	1	50/16	100	4	38.1/19	8	1

### Componente de refacerea ecranării

TRACON	Secțiune conductor (mm <sup>2</sup> )	Ecranare		Umplere		Altele
		Arc de pământare (mm <sup>2</sup> )	Tresă din CU stanat	Tip bandă de etanșare	Lungime (m)	Dimensiune bandă abrazivă
ZSVRS-1B2	4 × 6 – 4 × 25	2 buc. TRF1	1 buc. 0.7 m	ZSSZOH1,5	1	600 mm × 25 mm
ZSVRS-1K2	4 × 6 – 4 × 25	2 buc. TRF1	1 buc. 0.7 m	ZSSZOH1,5	1	600 mm × 25 mm
ZSVRS-2B2	4 × 35 – 4 × 50	2 buc. TRF2	1 buc. 0.7 m	ZSSZOH1,5	1	600 mm × 25 mm
ZSVRS-2K2	4 × 35 – 4 × 50	2 buc. TRF2	1 buc. 0.7 m	ZSSZOH1,5	1	600 mm × 25 mm
ZSVRS-3B2	4 × 70 – 4 × 120	2 buc. TRF4	1 buc. 0.7 m	ZSSZOH1,5	1	600 mm × 25 mm
ZSVRS-3K2	4 × 70 – 4 × 120	2 buc. TRF4	1 buc. 0.7 m	ZSSZOH1,5	1	600 mm × 25 mm
ZSVRS-4B2	4 × 150 – 4 × 240	2 buc. TRF5	2 buc. 0.7 m	ZSSZOH1,5	1	800 mm × 25 mm
ZSVRS-4K2	4 × 150 – 4 × 240	2 buc. TRF5	2 buc. 0.7 m	ZSSZOH1,5	1	800 mm × 25 mm

Papucii de cupru sau aluminiu se aleg în funcție de secțiunea conductoarelor (nu fac parte din set)

### Conținutul setului:

- Tub cu patru ramificații 1 buc. ①
- Tuburi de izolare papuci 4 buc. ②
- Tub de izolare fază, cu perete subțire, rezistent la raze UV (numai pentru exterior) ③
- Bandă abrazivă 1 buc. ④
- Bandă de etanșare de tip ZSSZOH1,5; 1 buc. ⑤
- Tresă metalică 1 buc. ⑥
- Arcuri de pământare 2 buc. ⑦

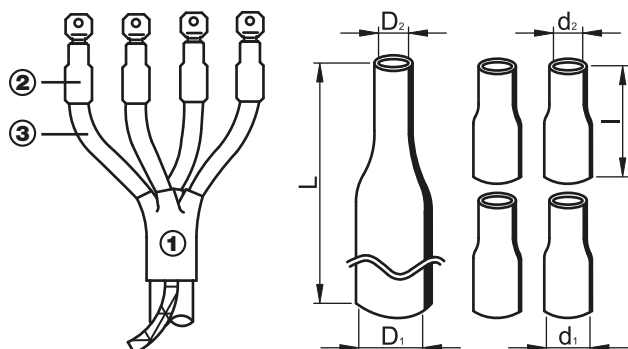



RELEVANT STANDARD  
**EN 60684**

TÜV MEEI TEST DOCUMENTATION  
**V-10238**

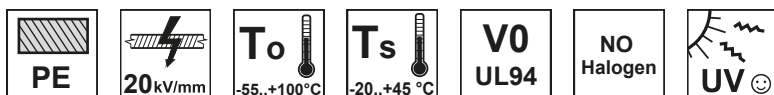

**Set manșon în linie, cu rășină**



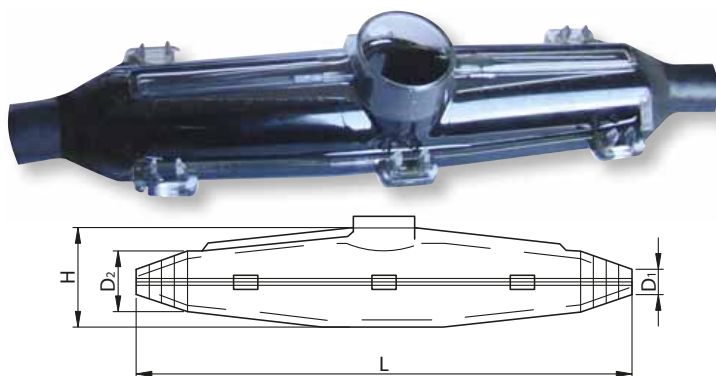

TRACON	 mm <sup>2</sup>	L (mm)	H (mm)	D <sub>1</sub> (mm)	D <sub>2</sub> (mm)
KET-1,5-10	4 × 1.5 – 4 × 10	210	36	8	26
KET-6-25	4 × 6 – 4 × 35	260	47	16	34
KET-16-50	4 × 25 – 4 × 70	360	55	21	43
KET-50-95	4 × 50 – 4 × 120	400	70	26	48
KET-70-150	4 × 70 – 4 × 150	530	100	35	63
KET-150-300	4 × 150 – 4 × 300	700	125	47	81



**Conținutul setului:**

- Carcasă din material plastic (PET) formată din două bucăți;
- Rășina din două componente cu element de separare din material plastic, ambalaj cu 5 straturi din AL laminat;
- Bandă PVC, hârtie abrazivă;
- Mănuși PE; Lavetă pentru curățire;
- Instrucțiuni de utilizare;

**Tabel pentru alegerea manșoanelor în funcție de tipul de cablu și secțiune:**

TRACON	KET-1,5-10	KET-6-25	KET-16-50	KET-50-95	KET-70-150	KET-150-300
 <b>3×</b> (mm <sup>2</sup> )	3 × 4 3 × 6 3 × 10 3 × 16	3 × 10 3 × 16 3 × 25 3 × 35	3 × 25 3 × 35 3 × 50 3 × 70	3 × 50 3 × 70 3 × 95 3 × 120	3 × 120 3 × 150 3 × 185	3 × 240
 <b>4×</b> (mm <sup>2</sup> )	4 × 1.5 4 × 2.5 4 × 4 4 × 6 4 × 10	4 × 6 4 × 10 4 × 16 4 × 25 4 × 35	4 × 25 4 × 35 4 × 50 4 × 70	4 × 50 4 × 70 4 × 95 4 × 120 4 × 150	4 × 70 4 × 95 4 × 120 4 × 150	4 × 150 4 × 185 4 × 240 4 × 300
 <b>5×</b> (mm <sup>2</sup> )	5 × 1.5 5 × 2.5 5 × 4 5 × 6 5 × 10	5 × 4 5 × 6 5 × 10 5 × 16 5 × 25	5 × 16 5 × 25 5 × 35 5 × 50	5 × 25 5 × 35 5 × 50	5 × 50	–





**RELEVANT STANDARD  
EN 50393**

## Set manșon derivație cu rășină (tip Y)



Legendă  
pictograme

D/O

TRACON	 (mm <sup>2</sup> )	 (mm <sup>2</sup> )	D <sub>1</sub> (mm)	D <sub>2</sub> (mm)	L (mm)	H (mm)
KYT-2,5	4 × 1.5 – 2.5	4 × 1.5	11	20	150	50
KYT-4-10	4 × 4 – 10	4 × 4	6	21	175	60
KYT-6-25	4 × 6 – 25	4 × 16	9	24	225	70

## Conținutul setului:



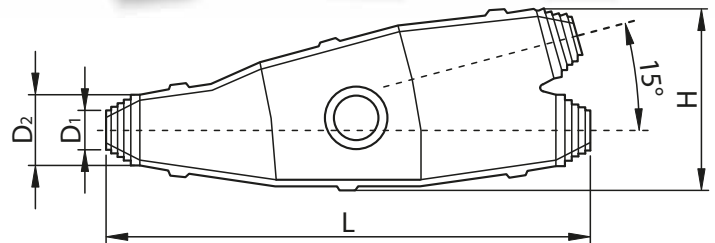



- Carcasă din material plastic (PET) formată din două bucăți;
- Rășina din două componente cu element de separare din material plastic, ambalaj cu 5 straturi din AL laminat;
- Bandă PVC, Hârtie abrazivă, Mănuși PE;
- Lavetă pentru curățire, Instrucțiuni de utilizare.



RELEVANT STANDARD  
EN 50393



## Rășină din două componente

TRACON	 ml	 g		To 		
KGY-80	80 ml	120 g	24 / 3 / 1 hour (5 / 23 / 35 °C)	5...60 °C	360 mg	20 kV
KGY-150	150 ml	197 g	24 / 3 / 1 hour (5 / 23 / 35 °C)	5...60 °C	400 mg	20 kV
KGY-464	464 ml	547 g	24 / 3 / 1 hour (5 / 23 / 35 °C)	5...60 °C	400 mg	20 kV

Valabilitatea rășinii este de 48 de luni de la data fabricației cu condiția ca aceasta să nu fie omogenizată. Temperatura de depozitare: 15...35 °C.

După îndepărtarea elementului separator din material plastic care se găsește pe pungă, cele două componente ale rășinii trebuie omogenizate rezultând un material care se poate turna ușor, dar care se solidifică în câteva minute asigurând protejarea împotriva pătrunderii apei și izolarea oricăror conexiuni electrice până la tensiunea nominală de 1 kV. Culoarea rășinii: neagră



## Cleme de legătură cu șurub pentru realizarea derivațiilor

Versiunile familiei de cleme pentru legături, tip YCSK, au fost special concepute pentru derivațiile de cablu. După îndepărtarea piuliței, în trunchiul filetat prin așchiere conductorul principal se poate introduce fără a fi întrerupt, iar deasupra se așează cel puțin un conductor de aceeași secțiune sau mai multe de secțiune mai mică pentru derivație, în funcție de locul disponibil.



A/13



## Capace termocontractabile

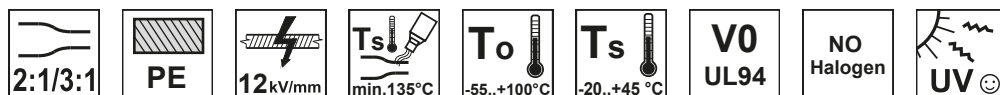

TRACON	4× (mm <sup>2</sup> )	3× (mm <sup>2</sup> )	1× (mm <sup>2</sup> )	D <sub>max</sub> (mm)	D <sub>min</sub> (mm)	L (mm)	L* (mm)
VES124	1 kV: 4×1,5	–	–	11.5	4	38	39
VES208	1 kV: 4×2,5 – 4×25	–	–	26	8	75	69
VES3515	1 kV: 4×35 – 4×70	10-30 kV: 3×50 – 3×120	10-30 kV: 1×50 – 1×120	35	15	110	106
VES5524	1 kV: 4×95 – 4×185	10-30 kV: 3×150 – 3×400	10-30 kV: 1×150 – 1×400	55	24	110	110
VES7533	1 kV: 4×240 – 4×300	20-35 kV: 3×185 – 3×300	20-35 kV: 1×185 – 1×300	74	35	130	120
VES10058	–	120-132 kV: 3×185 – 3×300	120-132 kV: 1×185 – 1×300	100	50	160	135



D<sub>max</sub> – diametre interioare înainte de contracție  
 D<sub>min</sub> – diametre interioare după contracție liberă  
 L – lungime totală înainte de contracție  
 L\* – lungime totală după contracție liberă



## Tuburi termocontractabile cu fermoar pentru reparații

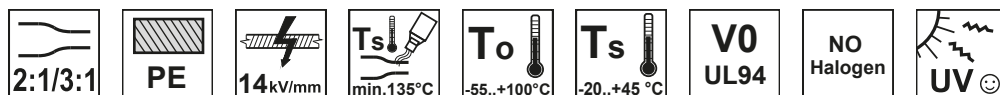

TRACON	mm <sup>2</sup>	D <sub>max</sub> (mm)	D <sub>min</sub> (mm)	S (mm)	S* (mm)	L (mm)
ZSJR50/05	4 × 6 – 4 × 25	50	15	1.1	3.3	500
ZSJR50/1	4 × 6 – 4 × 25	50	15	1.1	3.3	1000
ZSJR50/15	4 × 6 – 4 × 25	50	15	1.1	3.3	1500
ZSJR75/05	4 × 35 – 4 × 120	75	22	1.2	3.5	500
ZSJR75/1	4 × 35 – 4 × 120	75	22	1.2	3.5	1000
ZSJR75/22	4 × 35 – 4 × 120	75	22	1.2	3.5	1500
ZSJR146/05	4 × 150 – 4 × 240	146	38	1.2	3.5	500
ZSJR146/1	4 × 150 – 4 × 240	146	38	1.2	3.5	1000
ZSJR146/38	4 × 150 – 4 × 240	146	38	1.2	3.5	1500
ZSJR180/05	4 × 185 – 4 × 300	180	50	1.5	3.2	500
ZSJR180/1	4 × 185 – 4 × 300	180	50	1.5	3.2	1000
ZSJR180/15	4 × 185 – 4 × 300	180	50	1.5	3.2	1500



S – grosime perete înainte de contracție  
 S\* – grosime perete după contracție liberă



RELEVANT STANDARD  
**EN 60684**

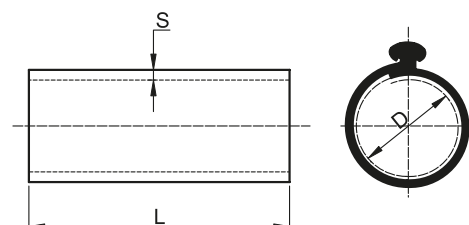

## Tub contractabil la rece



Legendă  
pictograme D/O

TRACON	D1 (mm)	D2 (mm)	S (mm)	L (mm)
HZS28-100	28	10	2,5	100
HZS36-100	36	17	2,5	100
HZS54-100	54	27	2,5	100
HZS92-100	92	32	3,0	100
HZS105-100	105	36	3,0	100
HZS28-200	28	10	2,5	200
HZS36-200	36	17	2,5	200
HZS54-200	54	27	2,5	200
HZS92-200	92	32	3,0	200
HZS105-200	105	36	3,0	200
HZS28-400	28	10	2,5	400
HZS36-400	36	17	2,5	400
HZS54-400	54	27	2,5	400
HZS92-400	92	32	3,0	400
HZS105-400	105	36	3,0	400

Tuburi contractabile la rece pe bază de silicon pentru izolarea conexiunilor electrice. Datorită tehnologiei asigură o etanșare flexibilă a legăturilor, nu sunt necesare unelte speciale sau flacără. Prin desfășurarea spiralei de sprijin tubul se micșorează pe cablul pregătit anterior. Datorită forței constante de strângere, oferă etanșare împotriva pătrunderii apei.

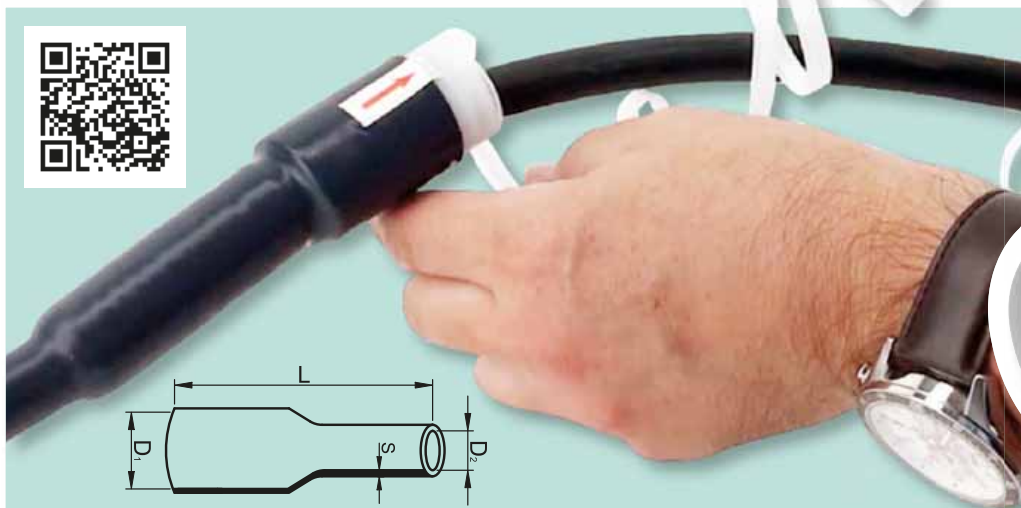

## Plasă de cupru ZSSZR5



Se utilizează pentru refacerea ecranării din punct de vedere electric. Se pot utiliza la tensiune joasă și medie.

Dimensiune: 5 m × 30 mm × 0,4 mm

Test	Date	Metode testare
<b>Întindere</b>	min. 70%	ASTM D412
<b>Forță de rupere</b>	min. 35 N/10 mm <sup>2</sup>	ASTM D412
<b>Rezistivitatea de volum</b>	min. 0.3 Ωcm	ASTM D257

## Bandă de etanșare ZSSZOH1,5

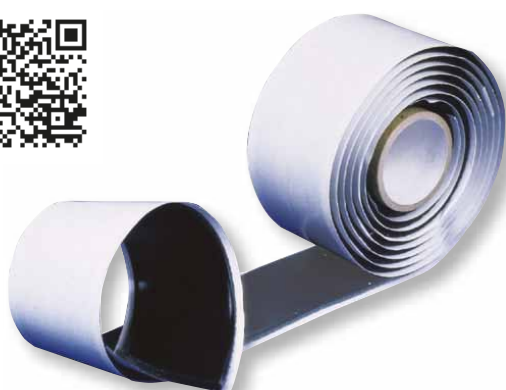

Se utilizează la seturi de manșoane și bransamente de tensiune medie. Servesc protecției sigure față de umiditate.

Dimensiune: 1,5 m × 38 mm × 3 mm

Culoare: negru

Test	Date	Metode testare
<b>Întindere</b>	min. 1000%	ASTM D412
<b>Forță de rupere</b>	min. 3 N/10 mm <sup>2</sup>	ASTM D412
<b>Rezistivitatea de volum</b>	min. 10 <sup>14</sup> Ωcm	ASTM D257
<b>Rigiditate electrică</b>	min. 3 kV/mm	ASTM D149

## Bandă de umplere ZSSZVM-1



Se utilizează la seturi de manșoane și bransamente de tensiune medie. Se utilizează la izolarea refacerea izolației conductorilor dintrun cablu și uniformizarea conexiunii.

Dimensiune: 1,5 m × 25 mm × 0,8 mm

Culoare: roșu

Test	Date	Metode testare
<b>Densitate</b>	1.3 g/cm <sup>3</sup>	UNI 7092
<b>Rigiditate electrică</b>	min. 15 kV/mm	UNI 4291
<b>Rezistivitatea de volum</b>	min. 1 × 10 <sup>12</sup> Ωcm	UNI 4288

## Arc de pământare



Se utilizează la seturi de manșoane și bransamente de tensiune medie pentru a apăsa plasa de cupru de tresa metalică a conductorului.

TRACON	D <sub>min</sub> (mm)	D <sub>max</sub> (mm)	Grosime (mm)
<b>TRF0</b>	12	19	0.2
<b>TRF1</b>	17	22	0.2
<b>TRF2</b>	19	29	0.2
<b>TRF3</b>	25	37	0.3
<b>TRF4</b>	31	50	0.3
<b>TRF5</b>	44	70	0.3
<b>TRF6</b>	58	94	0.4
<b>TRF7</b>	60	130	0.4

D<sub>min</sub>: Diametrul minim care poate fi strâns de arc

**LSJ**

**ILUMINAT STRADAL CU LED**

**TRACON**  
.....**ELECTRIC®**



**E/16-E/18**