

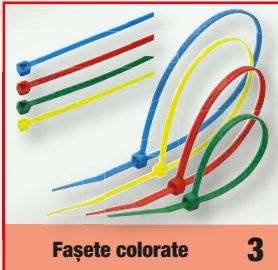

Fașete tradiționale 2



Fașete colorate 3



Fașete cu limbă metalică rezistente la UV 4



Fașete reutilizabile 5



Fașete cu perță 5



Fașete termorezistente 6



Fașete ignifuge 6



BK-130 Fașete cu ghimpe 6



Fașete cu etichetă 7



Fașete din oțel inoxidabil 7



Talpă de fixare pe muchie, cu fașetă 8



Bandă velcro pentru organizare cabluri 9



Suport de cablu auto-deziv 9



Talpă fașetă cu șurub 10



Dibluri pentru fașete 11



Cleme din plastic cu cui, pentru fixat cabluri 12



Cleme din material plastic pentru tuburi 12



Dibluri pentru fixat cabluri 13



Dibluri cu umăr având șurub cu cârlig sau cu cot 14



Diblu cu umăr și șurub hexagonal cu flanșă 14



Diblu ghips carton, cu bătaie 14



Diblu universal cu rezistență mare 15



Diblu ghips carton 15



Dibluri cu bătaie 16



Dibluri normale cu umăr 17



Ochi de protecție 18



Cârlige 19



Cleme cablu tip U 19



Cleme duble de fixat cabluri 20



Carabine cu arc 21



Întinzătoare 22



Bandă spirală pentru strângerea conductoarelor 23



Tub flexibil din material plastic cu autoînchidere 23



Sigilii de marcare 24



Sigilii pentru aparate de măsură 24

Pictogramele capului de tabel

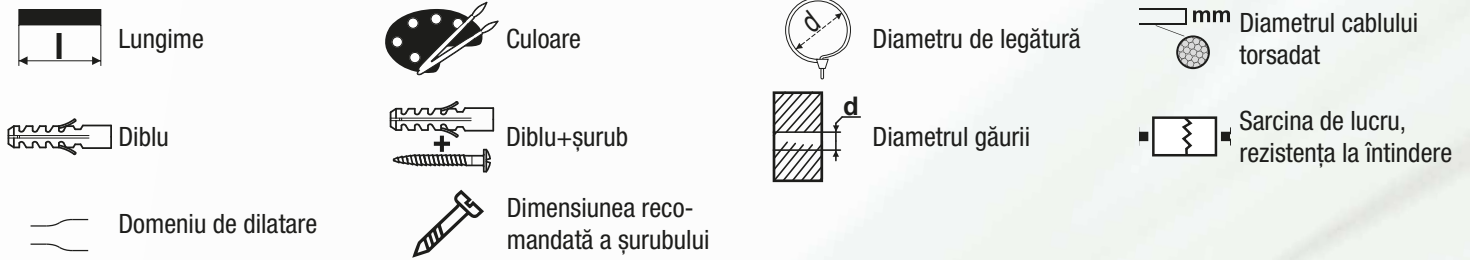

Pictogramele datelor tehnice

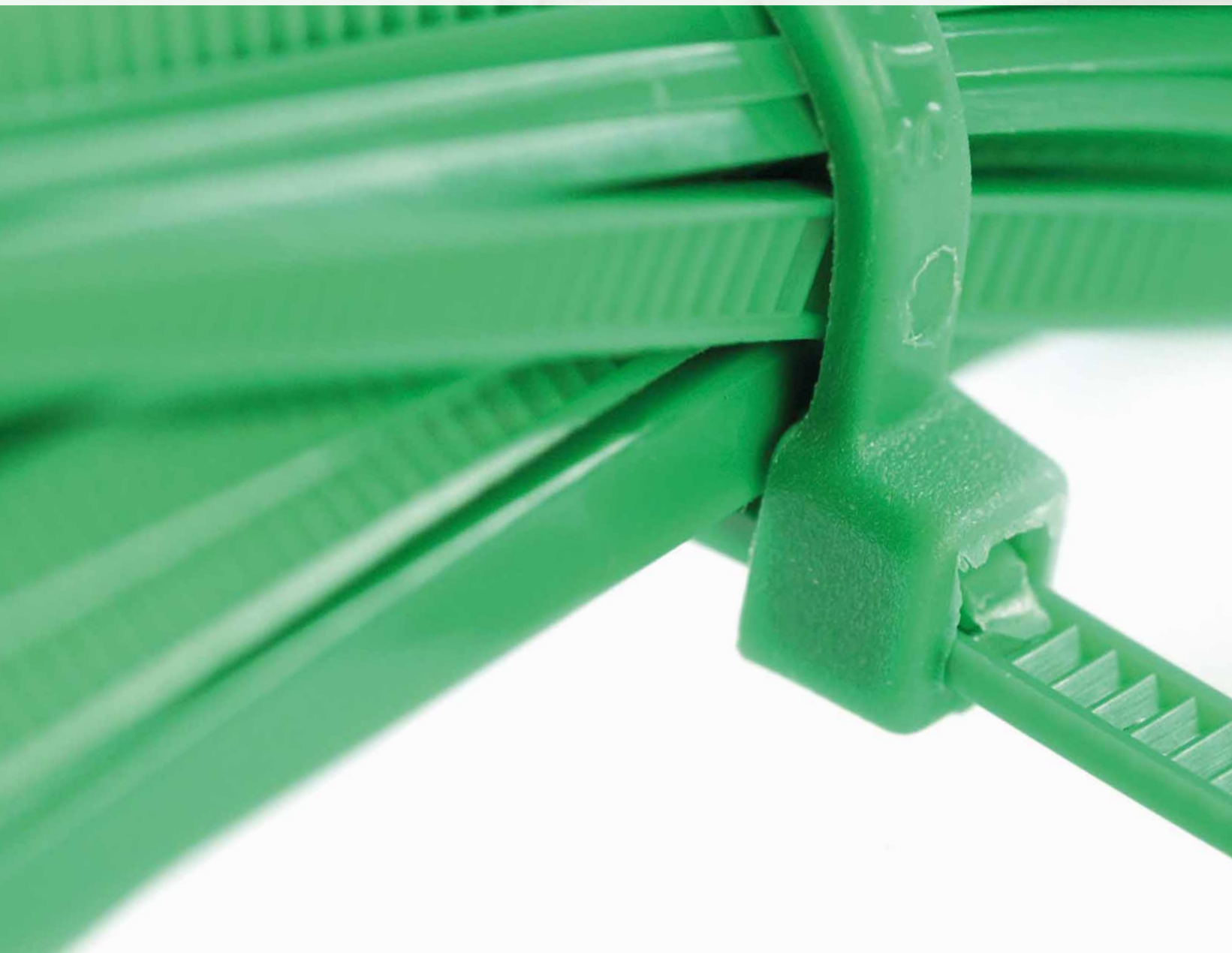

Fașete tradiționale

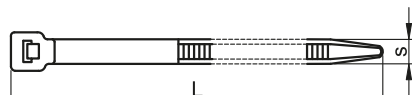
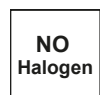
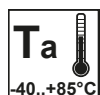

TRACON				
80PR		75 × 2.2 mm	0.75-15 mm	35 N
120PR		98 × 2.5 mm	1-21 mm	45 N
130PR		135 × 2.6 mm	1-32 mm	45 N
150PR		140 × 3.6 mm	2-36 mm	80 N
160PR		160 × 2.6 mm	1-40 mm	45 N
180PR		180 × 7.8 mm	3.5-45 mm	250 N
200PR		200 × 2.6 mm	1-52 mm	45 N
170PR		200 × 3.6 mm	2-50 mm	80 N
190PR		200 × 4.8 mm	3-50 mm	110 N
250PR		250 × 4.8 mm	3-68 mm	110 N
280PR		280 × 8.0 mm	4-65 mm	180 N
230PR		290 × 3.6 mm	2-80 mm	80 N
210PR		290 × 4.8 mm	3.5-79 mm	110 N
300PR		300 × 7.8 mm	5-80 mm	250 N
220PR		360 × 4.8 mm	3.5-103 mm	110 N
260PR		365 × 7.8 mm	8-100 mm	250 N
370PR		370 × 3.6 mm	5-108 mm	80 N
430PR		430 × 4.8 mm	3.5-115 mm	110 N
450PR		450 × 7.8 mm	35-130 mm	250 N
530PR		550 × 8 mm	10-160 mm	250 N
760PR		780 × 9 mm	35-233 mm	350 N
850PR		850 × 12.6 mm	40-255 mm	450 N
1000PR		1000 × 12.6 mm	40-302 mm	450 N
270PR		260 × 2.5 mm	3-73 mm	45 N
550PR		550 × 4.6 mm	4-160 mm	110 N
610PR		610 × 8.8 mm	9-181 mm	350 N
580PR		580 × 12.4 mm	9-168 mm	450 N



RELEVANT STANDARD
EN 62275



B/18

TG008

TG007



Rezistă timp îndelungat la: hidrocarburi, diluanți organici și alcool
 Pentru scurt timp rezistă la: acizi organici, săruri anorganice și alte combinații organice
 Nu rezistă la: acizi anorganici, soluții oxidante

Fașete colorate

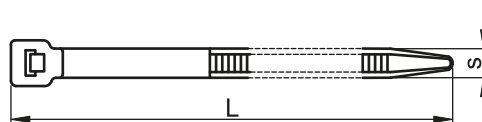
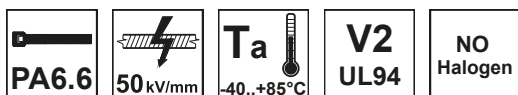

TRACON					
120K		98 × 2.5 mm	1-21 mm	45 N	
150P		140 × 3.6 mm	2-36 mm	80 N	
150Z		140 × 3.6 mm	2-36 mm	80 N	
200K		200 × 2.6 mm	1-52 mm	45 N	
170K		200 × 3.6 mm	2-50 mm	80 N	
170P		200 × 3.6 mm	2-50 mm	80 N	
190K		200 × 4.8 mm	3-50 mm	110 N	
230NZ		290 × 3.6 mm	2-80 mm	80 N	
170Z		203 × 3.6 mm	2 - 52 mm	80 N	
190Z		203 × 4.6 mm	2 - 52 mm	110 N	

RELEVANT STANDARD
EN 62275

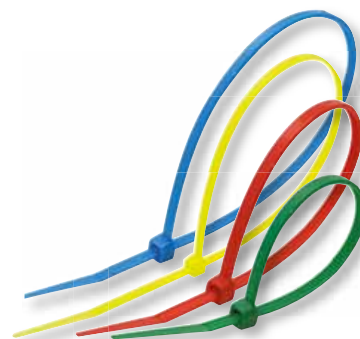

Fașete cu limbă metalică

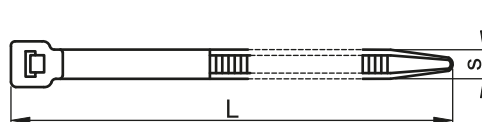
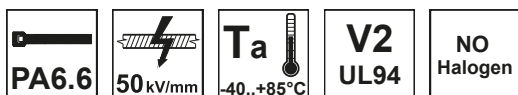

TRACON				
T92		92 × 2.4 mm	2-16 mm	35 N
T140		140 × 3.6 mm	2-29 mm	75 N
T186		186 × 4.8 mm	3.5-45 mm	110 N
T200		200 × 2.4 mm	2-50 mm	35 N
T208		208 × 3.6 mm	2-50 mm	75 N
T281		281 × 3.6 mm	2-76 mm	75 N
T293		293 × 4.8 mm	3.5-78 mm	110 N
T338		338 × 7.6 mm	3.5-120 mm	110 N
T360		360 × 4.8 mm	3.5-102 mm	110 N



Fașete cu limbă metalică rezistente la UV

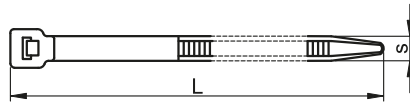

C/O

TRACON				
TU92		92 × 2.4 mm	2-16 mm	35 N
TU140		140 × 3.6 mm	2-29 mm	75 N
TU186		186 × 4.8 mm	3.5-45 mm	110 N
TU200		200 × 2.4 mm	2-50 mm	35 N
TU208		208 × 3.6 mm	2-50 mm	75 N
TU281		281 × 3.6 mm	2-76 mm	75 N
TU293		293 × 4.8 mm	3.5-78 mm	110 N
TU338		338 × 7.6 mm	3.5-120 mm	110 N
TU360		360 × 4.8 mm	3.5-102 mm	110 N



Fașete PA12

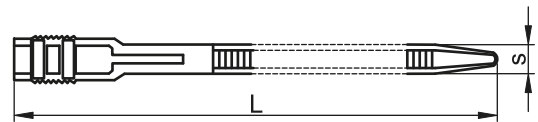

TRACON				
132-12		132 × 9.0 mm	4-27 mm	120 N
180-12		180 × 9.0 mm	5-45 mm	150 N
265-12		260 × 9.0 mm	25-65 mm	250 N
300-12		300 × 9.0 mm	25-80 mm	225 N
360-12		350 × 9.0 mm	25-93 mm	250 N



RELEVANT STANDARD
EN 62275

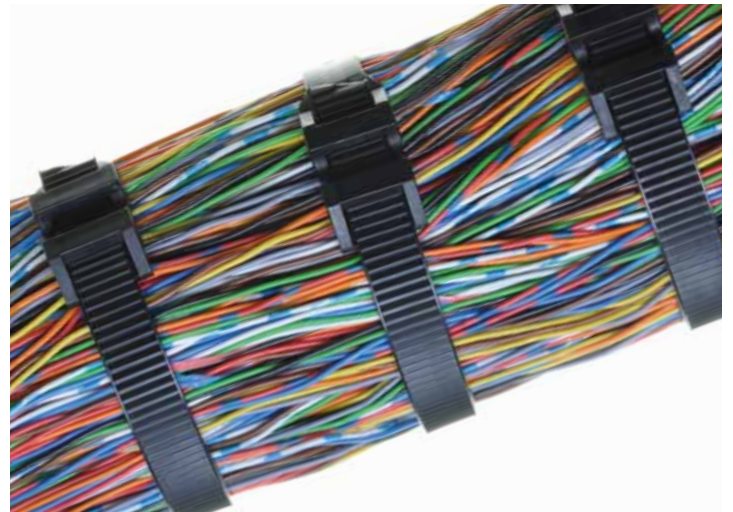

Fașete reutilizabile

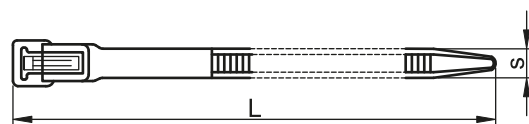
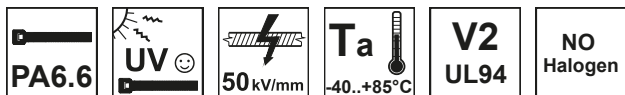

TRACON				
180-NY	181-NY	200 × 7.5 mm	10-50 mm	10-45 N
260-NY	261-NY	250 × 7.5 mm	10-65 mm	10-45 N
280-NY	281-NY	300 × 7.5 mm	10-70 mm	10-45 N
350-NY	351-NY	350 × 8 mm	10-120 mm	10-45 N





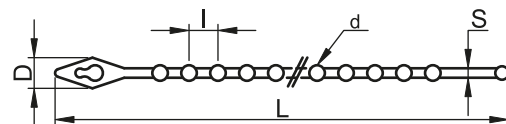
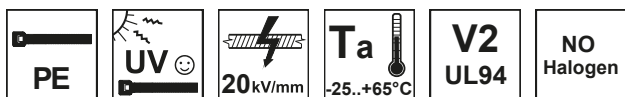

Fașete cu perlă





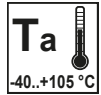
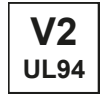

TRACON		L × S (mm)	d (mm)	D (mm)	I (mm)		
100N-GY	100F-GY	1.2 × 100	2.5	4.85	3	3 - 25 mm	45 N
120N-GY	120F-GY	120 × 1.3	2.5	5.5	3	6-25 mm	40 N
150N-GY	150F-GY	150 × 2	3	7.5	4.5	8-35 mm	40 N
160N-GY	160F-GY	1.7 × 150	2.6	7.73	4	4 - 38 mm	40 N
180N-GY	180F-GY	180 × 2	3	7.5	4.5	8-45 mm	40 N
200N-GY	200F-GY	1.8 × 200	2.5	7.63	5	5 - 59 mm	40 N



Fașete termorezistente



Legendă pictograme
C/O

TRACON

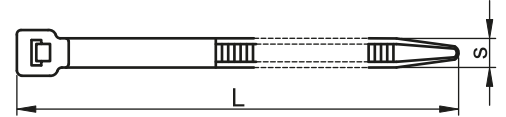
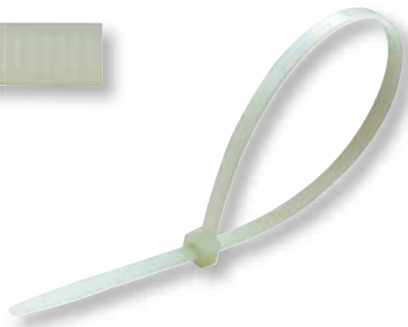



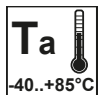
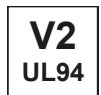



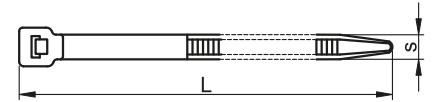





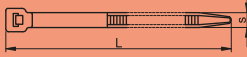

**RELEVANT STANDARD
EN 62275**

Fașete ignifuge







TRACON

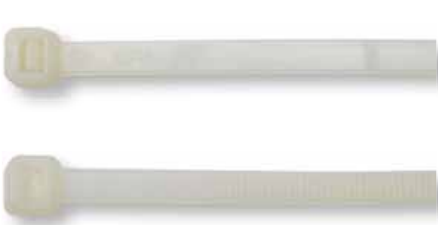



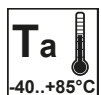
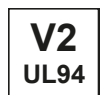





150L		3.6 × 150mm	4 - 36 mm	80 N
200L		4.6 × 200mm	4 - 52 mm	110 N
300L		4 × 300mm	4 - 81 mm	110 N
380L		7.6 × 380mm	9 - 108 mm	250 N



BK-130 Fașete cu ghimpe

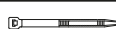
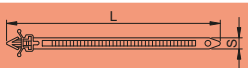





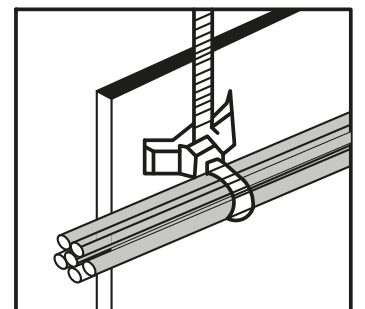
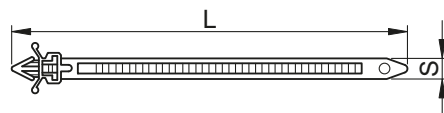
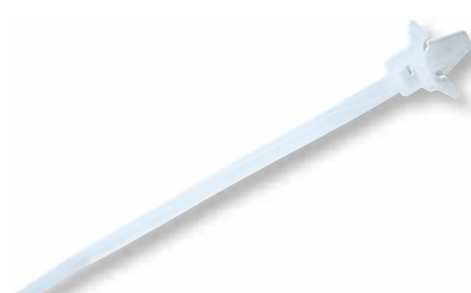





Legendă pictograme
C/O





TRACON







Fașete cu etichetă

Legendă pictograme
C/O

TRACON	L × S (mm)	a (mm)	b (mm)		
120J 	110 × 2.5	8	25	1-20 mm	40 N
190J 	190 × 3.6	27	13	10-48 mm	70 N
200J 	210 × 2.5	15	30	5-45 mm	40 N



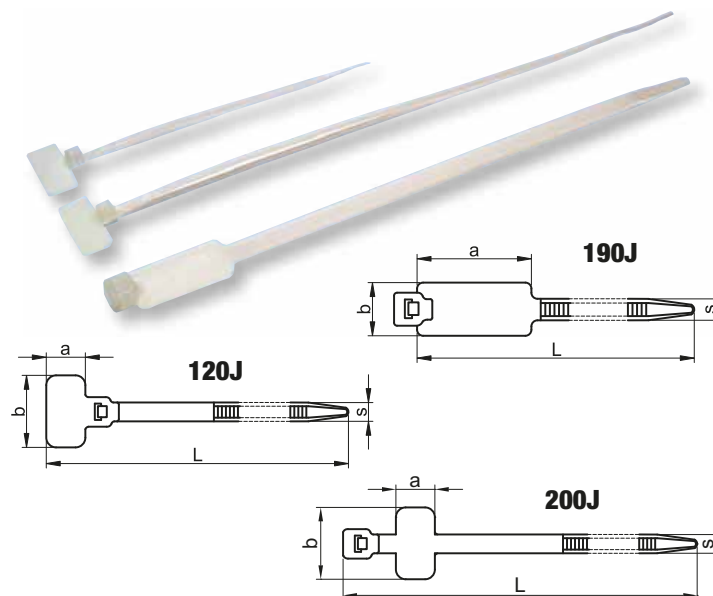

Fașete din oțel inoxidabil



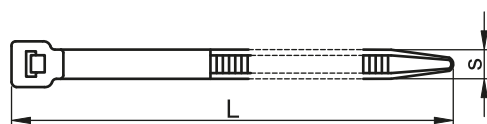

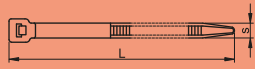

TRACON			
F125	125 × 4.6 mm	15 - 38 mm	350 N
F200	200 × 4.6 mm	15 - 61 mm	350 N
F201	200 × 7.9 mm	15 - 61 mm	450 N
F290	290 × 4.6 mm	15 - 90 mm	350 N
F291	290 × 7.9 mm	15 - 90 mm	450 N
F520	520 × 4.6 mm	15 - 163 mm	350 N
F521	520 × 7.9 mm	15 - 163 mm	450 N
F840	840 × 4.6 mm	15 - 265 mm	350 N
F841	840 × 7.9 mm	15 - 265 mm	450 N

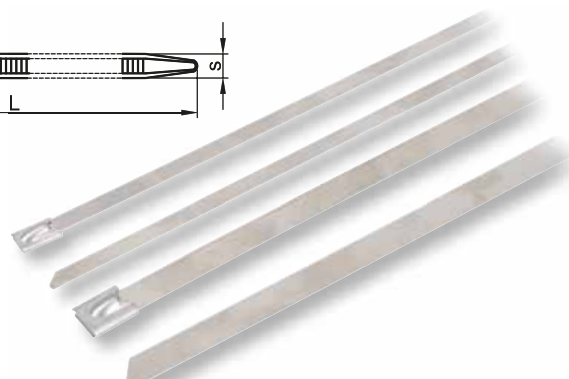
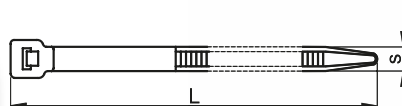

Cleme cu fașetă



C/O

TRACON					
110-CS		110 × 2.5 mm	3 - 19 mm	45 N	M2.5
150-CS		150 × 3.6 mm	3 - 35 mm	80 N	M4
160-CS		160 × 4.8 mm	3 - 36 mm	110 N	M5
200-CS		200 × 4.8 mm	3 - 49 mm	110 N	M5
300-CS		300 × 4.8 mm	3 - 82 mm	110 N	M5
310-CS		300 × 7.6 mm	8 - 78 mm	250 N	M6
370-CS		370 × 4.8 mm	3 - 103 mm	110 N	M5
400-CS		400 × 7.6 mm	8 - 109 mm	250 N	M6

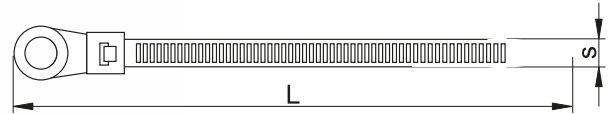

Talpă de fixare pe muchie, cu fașetă



C/O

TRACON					
CSKT		4.8 × 200mm	3 - 49 mm	110 N	

Grosimea maximă a muchiei 3 mm



Bandă velcro pentru organizare cabluri

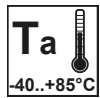

Legendă
pictograme

C/O

TRACON			
TKR130		130 x 12,5 mm	35 mm
TKR200		200 x 12,5 mm	35 mm
TKR300		300 x 12,5 mm	89 mm
TKR310		300 x 17 mm	92 mm
TKR-12T		22,8 m x 12,5 mm	-
TKR-20T		25 m x 20 mm	-



TKR-12T
TKR-20T

Suport de cablu autoadeziv



Legendă
pictograme

C/O

TRACON		L (mm)	W (mm)	H (mm)
OKT15		15	24	9
OKT20		20	24	9
OKT25		25	24	9
OKT28		28	24	9

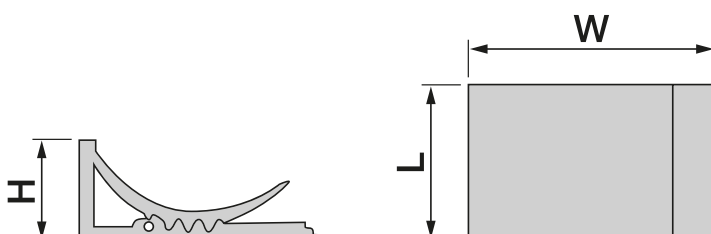

OKT28

OKT15

Talpă fașetă cu șurub

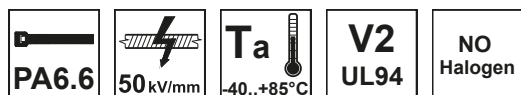

TRACON	a (mm)	b (mm)	L (mm)	d (mm)	D (mm)
CSTALP	15	10	5.1	3.5	7
CSTALP-3	12.8	7	4	3.3	5.8
CSTALP-2	23	16	9	6.3	9.8
CSTALP-4	16	11	5.3	3.5	7
CSTALP-5	22	15	8.3	5	9.5
CSTALP-6	26	16	9.5	5	10.7

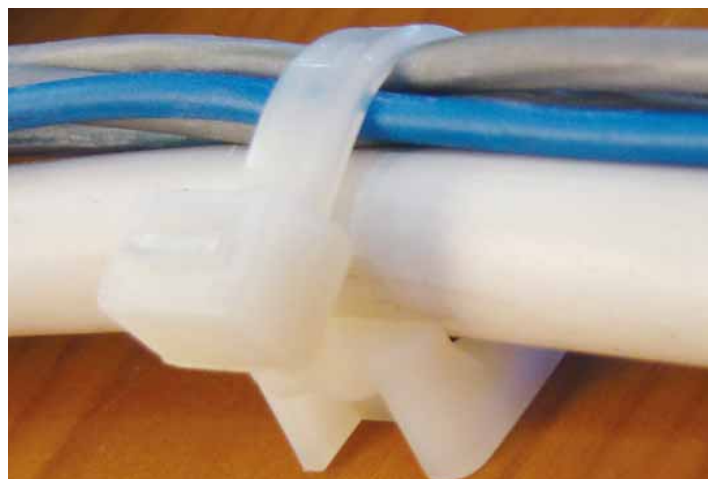
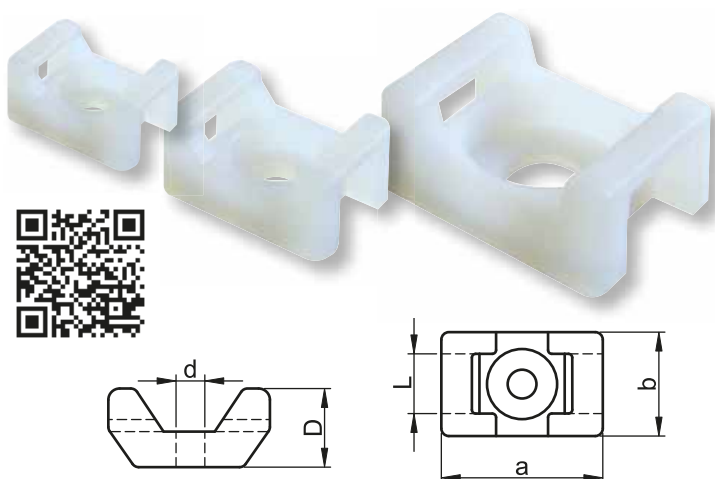

Talpă autoadezivă pentru fașete, cu 2 direcții de introducere

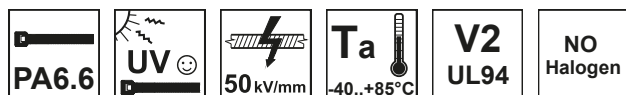

TRACON		a (mm)	b (mm)	L (mm)	d (mm)	D (mm)
TALP190-2		18.7	18.7	4	4.4	5.7
TALP191-2		18.7	18.7	4	4.4	5.7
TALP270-2		26.5	26.5	5.8	4.3	8.1
TALP271-2		26.5	26.5	5.8	4.3	8.1

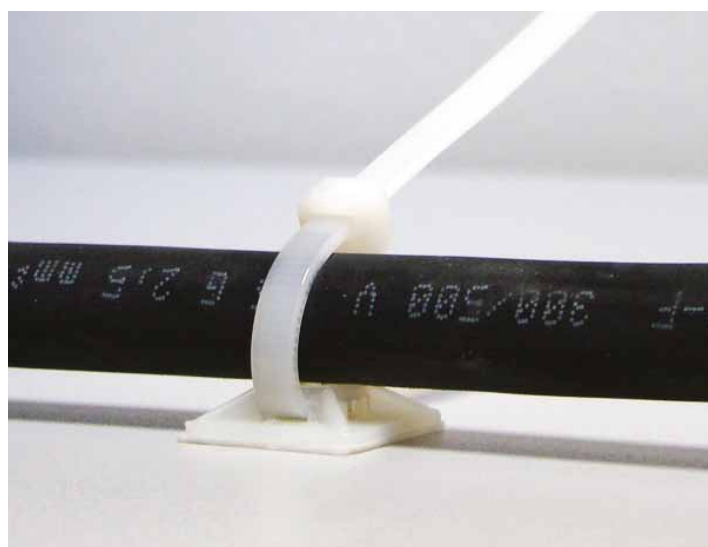
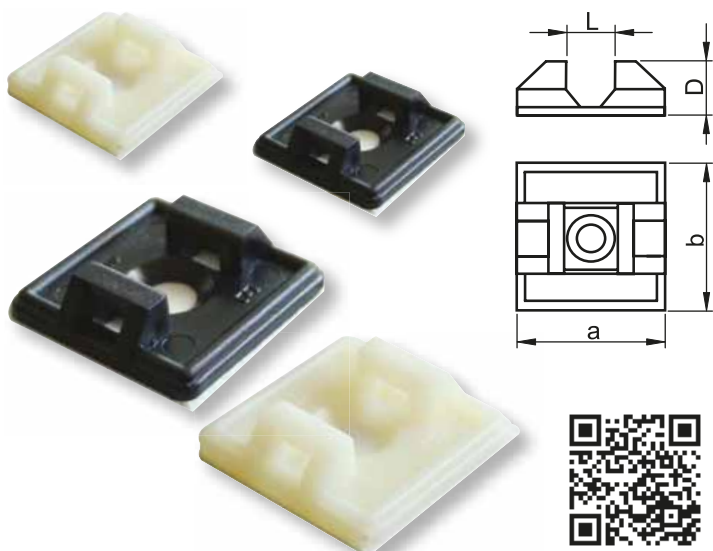

Talpă autoadezivă pentru fașete, cu 4 direcții de introducere

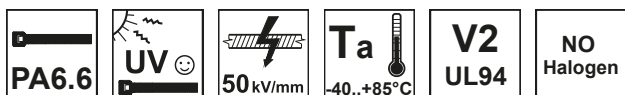

TRACON		a (mm)	b (mm)	L (mm)	d (mm)	D (mm)
TALP190		20	20	5	2.9	6.1
TALP191		20	20	5	2.9	6.1
TALP200		19	19	4.3	5	6
TALP201		19	19	4.3	5.7	6.5
TALP270		25	25	6.2	3.5	7.5
TALP271		25	25	6.2	3.5	7.5
TALP280		28	28	5.2	5.7	6.5
TALP281		28	28	5.2	5.7	6.5

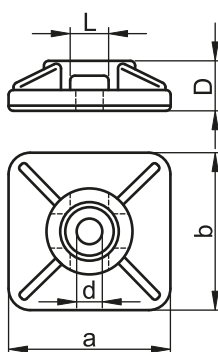

Dibluri pentru fașete

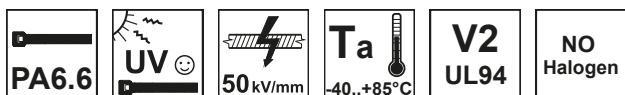

TRACON			a (mm)	b (mm)	c (mm)	W ₁ (mm)	W ₂ (mm)	L (mm)	D (mm)
5458		8 mm	10.6	6.3	3.1	12.8	12.6	43.8	9.9
5458N		7 mm	9.8	6.4	2.1	15.4	11.1	38.0	7.9
8138		7 mm	10.2	6.4	3	14.6	11	38	9.9
9843		8 mm	10.3	6.5	3.2	12.8	12.9	43.3	9.7

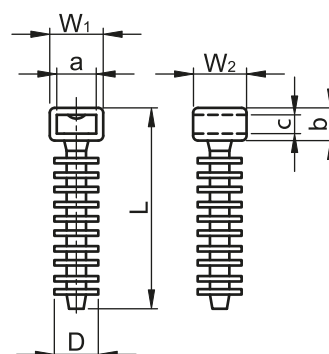
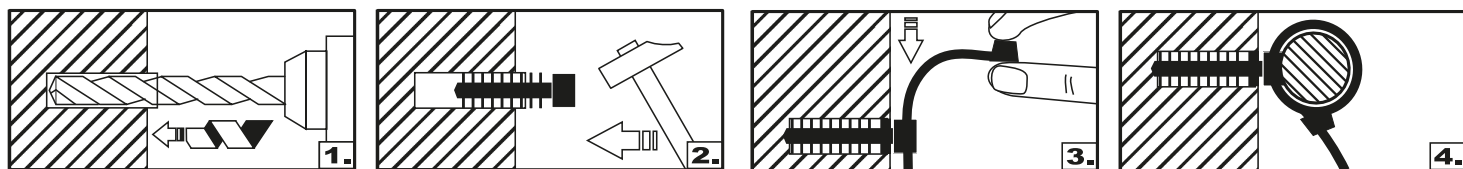

Cleme din plastic cu cui, pentru fixat cabluri

TRACON			a (mm)	b (mm)
100 pcs	20 pcs			
NOF	NOF-20		2.5	4.5
N1	N1-20		6	7.3
N2	N2-20		8	8.1
N3	N3-20		9	8.3
N4	N4-20		11	10

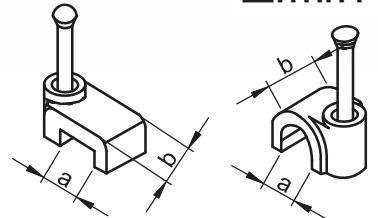

Cleme din material plastic pentru tuburi



TRACON		D (mm)	W (mm)	L (mm)	H (mm)
CSS-16		16	29.3	12.9	21.7
CSS-20		20	33	12.9	24.2
CSS-25		25	37.5	12.9	27.9

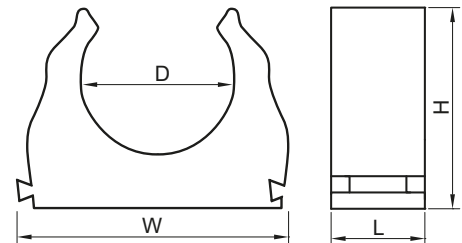



Clipsuri pentru fixat cabluri sau tuburi

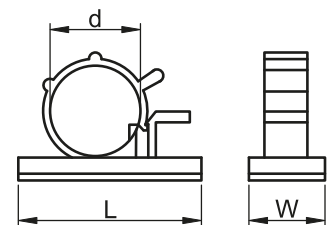

TRACON		d (mm)	W (mm)	L (mm)
TKCR-0708		7-8	20	25

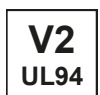

Clemă cu blocare pentru cabluri și țevi







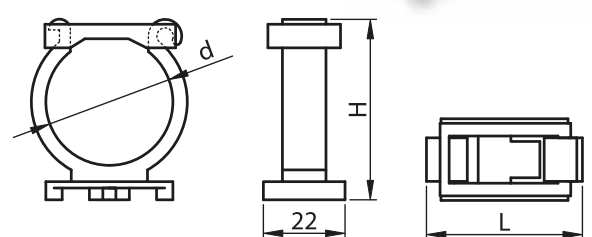
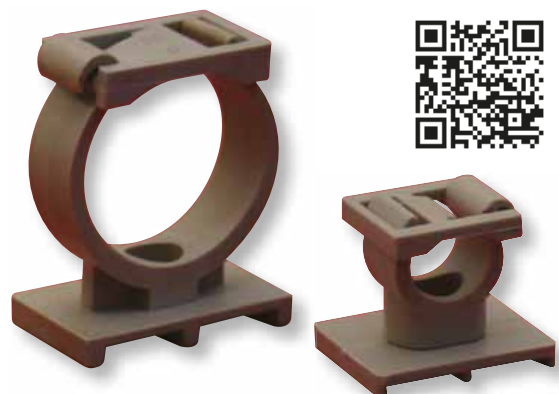

TRACON		d (mm)	L (mm)	H (mm)
TKCRZ-12		12	28	24.5
TKCRZ-15		15	28	28.5
TKCRZ-18		18	28	33
TKCRZ-22		22	34	37
TKCRZ-28		28	38,5	45
TKCRZ-32		32	38	47.5
TKCRZ-35		35	41	49

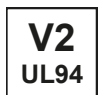

Cleme de fixat tuburi și cabluri





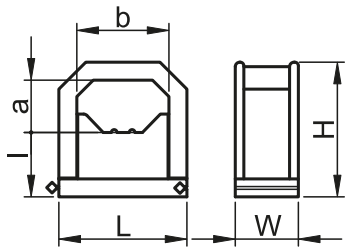

Legendă pictograme
C/O

TRACON		a (mm)	b (mm)	L (mm)	l (mm)	H (mm)	W (mm)
BCSV-3		10-18	18.6	26.4	16.2	19.8-37.5	17.7
BCSV-4		19-31	28.8	39.4	15.1	39.5-51.6	18.2

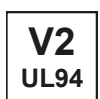

Dibluri pentru fixat cabluri

Legendă pictograme
C/O

TRACON		d ₁ (mm)	d ₂ (mm)	B (mm)	L (mm)
KRT		6	6	10	36.5
KRT8		8	7.7	12.2	42.7

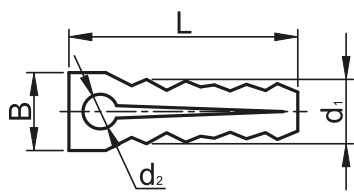

Dibluri cu umăr având șurub cu cârlig sau cu cot



TRACON		D × L (mm)	d (mm)	l ₁ (mm)	l ₂ (mm)	B (mm)
T6H		6 × 30	3.3	37	24.2	15.4
T6K		6 × 30	3.3	38.5	10	13.4

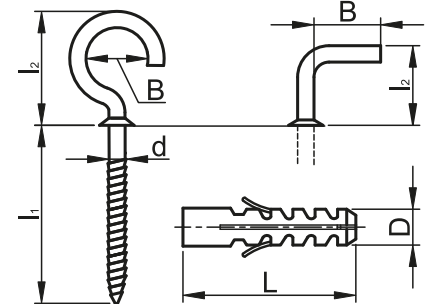

Diblu cu umăr și șurub hexagonal cu flanșă



TRACON	D × L (mm)	d × l (mm)
T10080P	10 × 80	6.8 × 95
T10100P	10 × 100	6.8 × 115
T10120P	10 × 120	6.8 × 135
T10140P	10 × 140	6.8 × 155
T10160P	10 × 160	6.8 × 175
T10200P	10 × 200	6.8 × 215
T10240P	10 × 240	6.8 × 255
T10300P	10 × 300	6.8 × 315

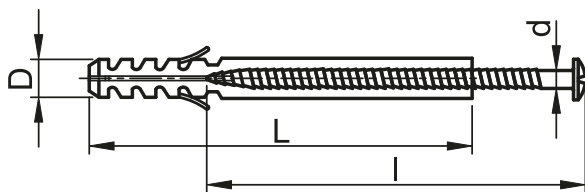

Diblu ghips carton, cu bătaie

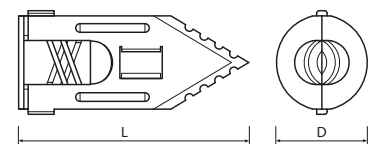

TRACON	D × L (mm)	
GTL30	10,5 × 30	3,5-4 mm
GTL40	10,5 × 40	3,5-4 mm
GTL43	16 × 43	3,5-4 mm



Diblu universal cu rezistență mare



V2
UL94

Ta
-40...+85°C



Legendă
pictograme

C/O

TRACON	D × L (mm)	d × l (mm)*
T5-UNI	5 × 25	3.5 × 35
T6-UNI	6 × 30	4 × 40
T8-UNI	8 × 40	5 × 50
T10-UNI	10 × 50	6 × 60

* Dimensiunea recomandată a șurubului

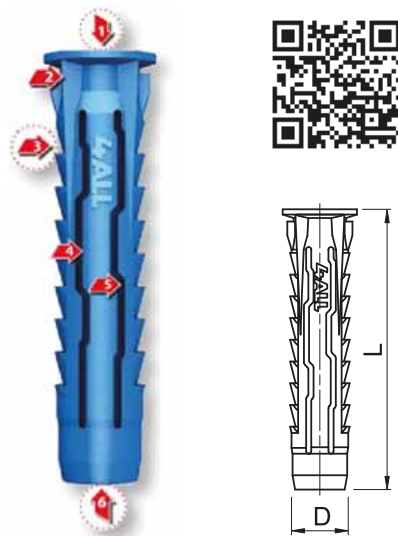

Construcție interioară unică, în care șurubul se potrivește foarte bine.



Urechi împotriva răsucirii care se fixează în toate materialele, chiar și în materiale de construcție moi.



Dințarea de sub cap crește siguranța fixării în toate materialele.

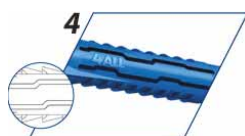

Partea care expandează este astfel construită încât la materialul cu goluri, prin scurtare se va deschide, fixând astfel perfect.



Deschiderea în 4 direcții îl face potrivit pentru utilizarea în orice material și orice tip de zidărie.



Construcția întărită a capătului asigură ținerea corespunzătoare a șurubului în timpul montajului.



Beton



Element de zidărie cu goluri



Placă ghips-carton

Diblu ghips carton



V2
UL94

Ta
-40...+85°C



TRACON	Denumire	D × L (mm)	d × l (mm)*
GBT	Diblu autoperforant pentru ghips carton	16 × 36	4 × 35
GSZT	Diblu ghips carton cu aripi	10 × 55	4 × 50

* Dimensiunea recomandată a șurubului

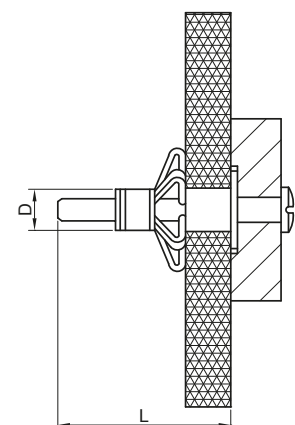

GSZT

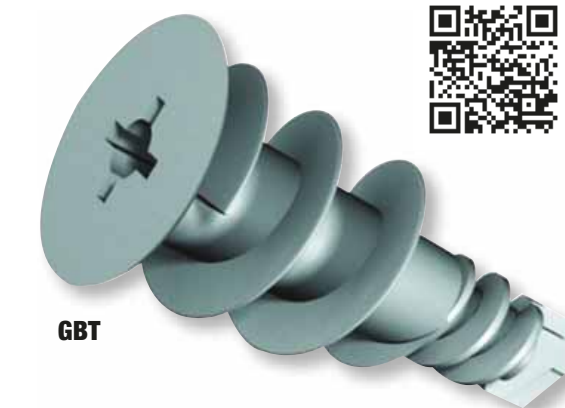

GBT

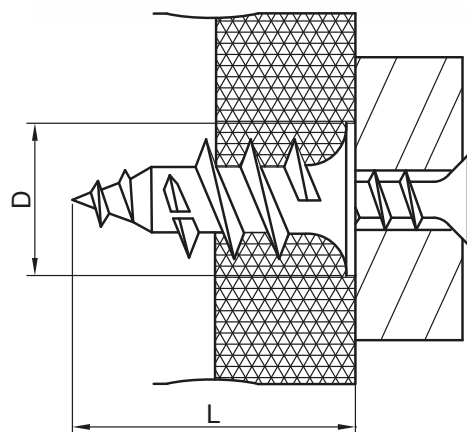

Dibluri cu secțiune pătrată



V2
UL94

Ta
-25..+65°C

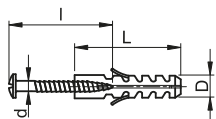

TRACON		D × L (mm)	d × l (mm)
TN6	TNCS6	6 × 23	2.6 × 30
TN8	TNCS8	8 × 34	3.5 × 38
TN10	TNCS10	10 × 42	4.4 × 46
TN12	TNCS12	12 × 52	5.4 × 61
TN14	-	14 × 65	-



Legendă
pictograme

C/O

Dibluri cu bătaie



V2
UL94

Ta
-40..+85°C

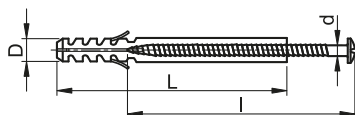

TRACON			TRACON		
	D × L (mm)	d × l (mm)		D × L (mm)	d × l (mm)
TB525	5 × 25	3.5 × 29	TB845	8 × 45	4.9 × 48
TB535	5 × 30	3.5 × 38	TB860	8 × 60	4.4 × 60
TB545	5 × 50	3.5 × 47	TB875	8 × 80	4.7 × 78
TB635	6 × 35	3.7 × 39	TB8100	8 × 100	4.7 × 102
TB645	6 × 40	3.7 × 48	TB8120	8 × 120	4.4 × 122
TB655	6 × 55	3.7 × 58	TB8135	8 × 135	4.4 × 137
TB670	6 × 80	3.2 × 83			



Dibluri alungite



V2
UL94

Ta
-40..+85°C

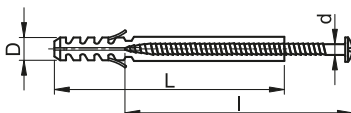

TRACON		D × L (mm)	d × l (mm)
-	THC8100	8 × 100	5.3 × 104
TH8120	THC8120	8 × 120	5.5 × 126
TH8135	THC8135	8 × 135	5.4 × 134
TH1080	THC1080	10 × 80	6.8 × 85
TH10100	THC10100	10 × 100	6.8 × 105
TH10115	THC10115	10 × 115	6.8 × 119
TH10135	THC10135	10 × 135	6.8 × 141
TH10160	THC10160	10 × 160	7 × 165



Dibluri normale

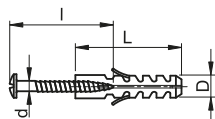
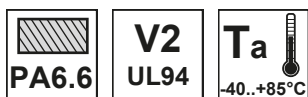

TRACON		D × L (mm)	d × l (mm)
		6 × 30	4 × 40
T6-PA	T6CS-PA	6 × 30	4 × 40
T8-PA	T8CS-PA	8 × 40	5 × 50
T10-PA	T10CS-PA	10 × 50	5.5 × 60
T12-PA	-	12 × 60	-
T14-PA	-	14 × 75	-

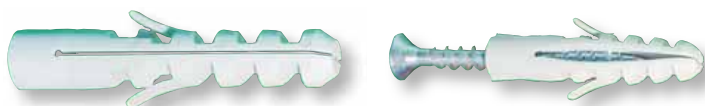

Legendă pictograme **C/O**

Dibluri normale cu umăr

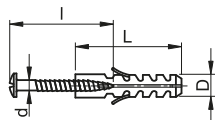
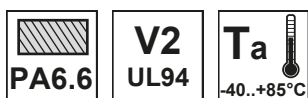

TRACON		D × L (mm)	d × l (mm)
-	T6PCS-PA	6 × 30	4 × 40
T8P-PA	T8PCS-PA	8 × 40	5 × 50
T10P-PA	T10PCSPA	10 × 50	5.5 × 60
T12P-PA	-	12 × 60	-



Dibluri cu auto-strângere

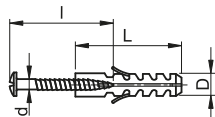
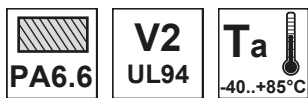

TRACON		D × L (mm)	d × l (mm)
		6 × 40	4 × 50
TOP6	TOPCS6	6 × 40	4 × 50
TOP8	TOPCS8	8 × 50	5 × 60
TOP10	TOPCS10	10 × 60	6 × 70



CITIȚI CODUL !

- Vezi noutățile noastre
- Fiți informat

Gama de produse se dezvoltă continuu și rapid!
 Catalogul nostru reflectă situația din Aprilie 2021.
 Pentru informații actualizate vizitați pagina
 noastră de internet!

Dibluri de tavan fals

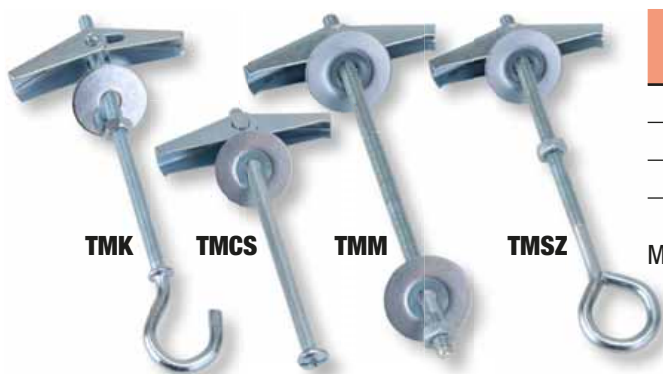

TRACON	d (mm)	L (mm)	a (mm)	B (mm)	
TMK	M4	95	20	14	200 N
TMCS	M4	81	20	-	800 N
TMM	M4	100	20	-	800 N
TMSZ	M4	93	20	14	200 N

Material: oțel, cu strat protector din crom

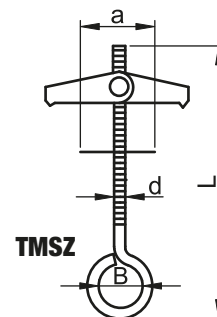
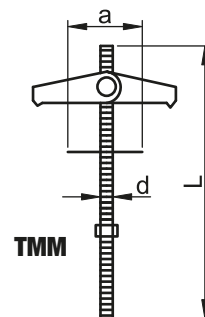
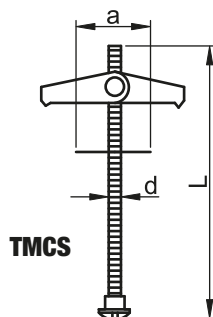
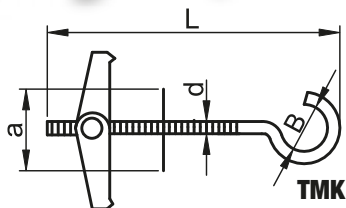

Ochi de protecție

TRACON	W (mm)	I (mm)	L (mm)	c (mm)	s (mm)	
SZIV-3	4.5	41.6	46.3	17	1	1 – 3 mm
SZIV-4	5.5	37.7	41.7	15	1	3 – 4 mm
SZIV-5	6.2	37.8	42.4	15	1	4 – 5 mm
SZIV-6	9	42.8	47.5	18.1	1	5 – 6 mm
SZIV-8	9.4	47.7	54.5	19.2	1.5	6 – 7 mm
SZIV-10	12.1	53.8	59.7	21.9	1.5	7 – 9 mm
SZIV-12	17.1	62.4	68.5	28.8	1.5	9 – 12 mm
SZIV-16	21.1	75.7	82.9	39.2	2	12 – 14 mm
SZIV-19	21.6	80.6	90.3	42.2	2.3	16 – 19 mm

Material: oțel

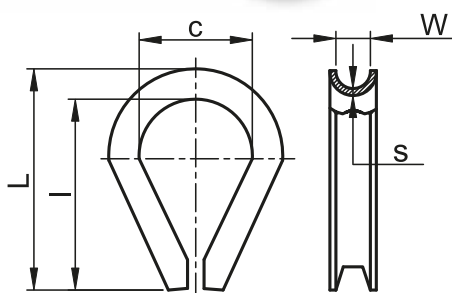

Cârlige

TRACON	d (mm)	L (mm)	l (mm)	m (mm)	D (mm)	
HR3-25	3	26	20.2	3	7	320 N
HR3-30	3	31.1	25.5	4.8	8.8	320 N
HR4-30	4	33.4	25.5	4.8	10	575 N
HR4-35	4	35.3	27.5	5.2	10.2	575 N
HR4-40	4	41	33.3	5.9	10.9	575 N
HR5-45	4.8	46	36.7	6.6	12.5	730 N
HR5-50	5	53.5	44	10.3	15.3	885 N
HR6-80	6	80	69	12	24	1250 N
HR8-100	8	104	88	17	31	2000 N

Material: oțel



C/O

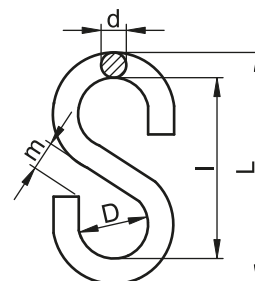

Cleme cablu tip U

TRACON	d (mm)	D (mm)	W (mm)	H (mm)	h (mm)	L (mm)	 mm
U03	M4	5.4	9.5	20.4	7.3	18	2-3 mm
U05	M5	7.2	9.6	24.2	7.5	21.5	3.2-5 mm
U06	M5	8.0	11.2	24.2	9.5	23.8	4.5-7 mm
U08	M6	9	12.9	35.4	10.4	27.4	6.3-8 mm
U09	M8	10.5	16.6	37.3	12.7	33	8-9 mm
U11	M8	11	18.4	41	16	36.4	10-11 mm
U13	M10	14.8	20.6	54.7	18.7	42.2	12-14 mm
U14	M10	14.9	24.2	55.2	23	43.7	12-14 mm
U16	M10	18.2	26	62	25.2	49.9	14-16 mm
U19	M12	21.5	29.7	76.8	30.2	54.4	16-19 mm
U22	M12	21.5	31	77.8	33.2	56.7	19-22 mm
U25	M14	27.7	32.8	95.7	34.5	63.3	22-25 mm

Material: șurub – oțel, corp – turnat

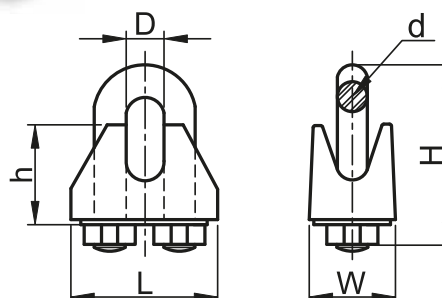

Cleme simple de fixat cabluri

TRACON	d (mm)	b (mm)	B (mm)	H (mm)	L (mm)	k (mm)
BSZ1-2	M4	5.1	13.6	6.1	17.2	13
BSZ1-3	M4	6.4	15.3	7	18.4	13.6
BSZ1-4	M5	10	16.6	6.5	21	17.4
BSZ1-5	M5	10.4	18.7	8.9	24.4	16.9
BSZ1-6	M6	12.5	23.3	9.6	30.2	21.6
BSZ1-8	M8	18.6	30.4	13.5	36.5	29.2

Material: oțel

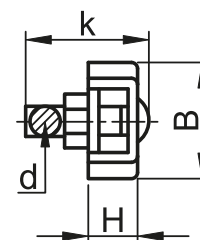
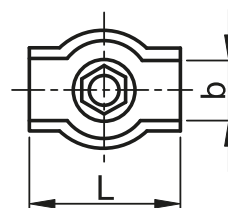

Cleme duble de fixat cabluri

TRACON	d (mm)	b (mm)	B (mm)	H (mm)	L (mm)	k (mm)
BSZ2-2	M4	5.8	12.9	5	36.6	13.4
BSZ2-3	M4	6.4	15.3	6.7	35.2	13.5
BSZ2-4	M5	8.4	17.5	7.1	40	17.6
BSZ2-5	M5	11.9	20.4	8.8	48.8	19.6
BSZ2-6	M6	12.5	23.3	9.6	60.5	21.6
BSZ2-8	M8	18.6	30.4	13.5	73	29.2

Material: oțel

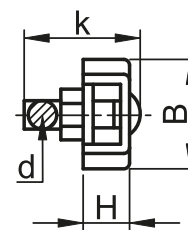
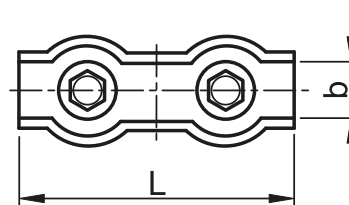

Clemă cablu Acelmax

TRACON	d (mm)	W (mm)	H (mm)	L (mm)	k (mm)	
AMAX3	M3	16.1	10.2	28.6	12.7	3 mm (1/8")
AMAX5	M5	17.5	10.7	30.5	12.4	5 mm (3/16")
AMAX6	M6	22.9	12.9	34.9	15.9	6 mm (1/4")

Material: oțel

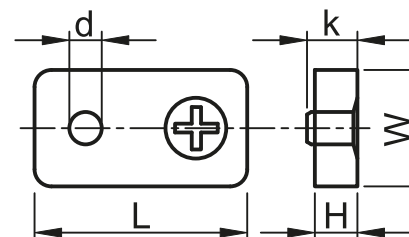

Carabine cu arc

TRACON	d (mm)	D (mm)	W (mm)	L (mm)	m (mm)	
RKARA4	4.5	5.8	21.1	42.0	5.5	300 N
RKARA5	5	6.6	26	51.3	7.2	500 N
RKARA6	6	6.9	30.2	62.3	7.7	800 N
RKARA7	7	7.8	35.1	70.7	8.7	1100 N
RKARA8	8	8.1	40.4	80.5	10.2	1400 N
RKARA9	9	9.7	45	90.3	11.7	1700 N
RKARA10	10	11.1	47.3	99.8	13.4	2100 N
RKARA11	11	12.3	57.3	121.2	16.5	2500 N
RKARA12	12	13.9	63.2	142.5	20.8	2700 N
RKARA13	13	15.8	72.8	149.4	24.1	3000 N

Material: oțel

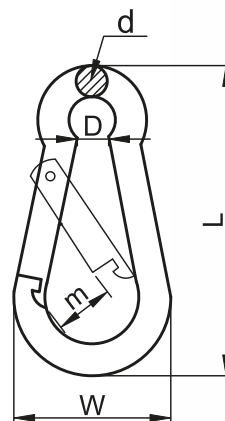



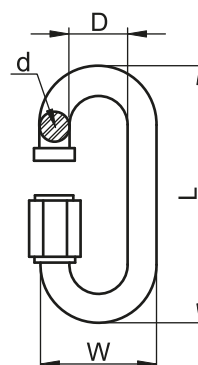

Carabine cu șurub

TRACON	d (mm)	D (mm)	W (mm)	L (mm)	
CSKARA3,5	3.5	10.8	17.9	35.5	420 N
CSKARA4	4	11.6	19.7	40.6	850 N
CSKARA5	5	13.6	23.5	50.9	1270 N
CSKARA6	6	14.7	26.7	58.3	1700 N
CSKARA7	7	18.4	32	68.2	2550 N
CSKARA8	8	19.6	36	73.8	3100 N
CSKARA9	9	20.6	39.2	82.2	4250 N
CSKARA10	10	21.6	42.4	89.6	5100 N
CSKARA12	12	23.5	48.3	106.2	6400 N

Material: oțel



Întinzătoare

TRACON			d (mm)	l (mm)	L (mm)	d (mm)	
			5	50	92.6	7.8	750 N
FSS570	FSH570	FHH570	5	70	113	8	770 N
FSS660	FSH660	FHH660	6	60	112	10	1050 N
FSS6100	FSH6100	FHH6100	6	100	154	10.2	1800 N
FSS870	FSH870	-	8	70	137	12.3	1200 N
FSS8110	FSH8110	FHH8110	8	110	176	12.3	2000 N
FSS10120	FSH10120	FHH10120	10	120	194	13.3	3000 N
FSS12130	FSH12130	FHH12130	12	130	224	18.3	4450 N
-	FSH16140	FHH16140	16	140	265	22	5950 N

Material: șurub – oțel, corp – turnat



FSS







FSH

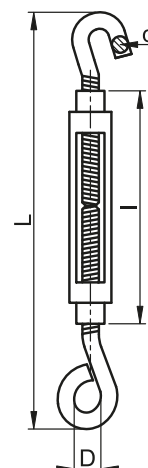



FHH



Spirală pentru strângerea conductoarelor

TRACON	d (mm)	D (mm)	s (mm)		
SPI6	6.2	8.6	1.9	1 m	6 mm
SPI8	8	10.9	2.4	1 m	8 mm
SPI10	10	13.2	2.9	1 m	10 mm
SPI12	12	15.4	2.9	1 m	12 mm
SPI15	15	17.1	2.9	1 m	15 mm
SPI20	20	24	3	1 m	20 mm
SPI25	25	28.7	3	1 m	25 mm

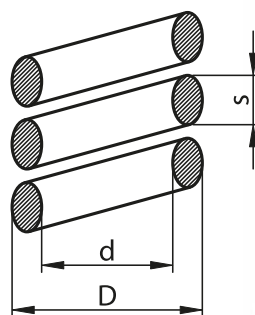

CITIȚI CODUL !

- Vezi noutățile noastre
- Fiți informat

Gama de produse se dezvoltă continuu și rapid!
 Catalogul nostru reflectă situația din Aprilie 2021.
 Pentru informații actualizate vizitați pagina noastră de internet!

Bandă spirală pentru strângerea conductoarelor



HB
UL94



TRACON		D (mm)	d (mm)	W (mm)		
KSPI-4N	KSPI-4F	4.5	3.2	6.8	10 m	4...20 mm
KSPI-6N	KSPI-6F	6.9	5.3	10.3	10 m	7...40 mm
KSPI-8N	KSPI-8F	8.4	6.6	11.7	10 m	12...50 mm
KSPI-10N	KSPI-10F	10.2	8.2	13.4	10 m	13...70 mm
KSPI-12N	KSPI-12F	12.2	9.6	15.9	10 m	15...80 mm
KSPI-16N	KSPI-16F	15.7	12.4	21.6	10 m	20...120 mm

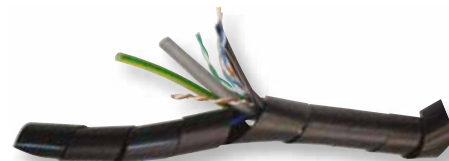
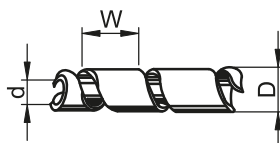

Tub flexibil din material plastic pentru conductoare



V2
UL94



TRACON		
TKH-003	3 mm	2.4 – 6.4 mm
TKH-010	10 mm	4.8 – 15.9 mm
TKH-016	16 mm	9.5 – 25.4 mm
TKH-025	25 mm	15.9 – 36.1 mm
TKH-032	32 mm	19.1 – 44.5 mm

Are avantajul că, pe lângă protejarea mecanică a cablului, datorită flexibilității de grad înalt și capacității mari de dilatare, poate urmări în mod excepțional traseul cablurilor și poate prelua eventualele modificări ale diametrelor acestora. Tăierea la dimensiuni se poate face cu letcon prevăzut cu vârf special sau cu cuțit fierbinte, astfel suprafața de tăiere nu se desface și nu se sfarmă. Structura întretesută nu acumulează căldura și vaporii de apă.



Tub flexibil din material plastic cu autoînchidere





V2
UL94

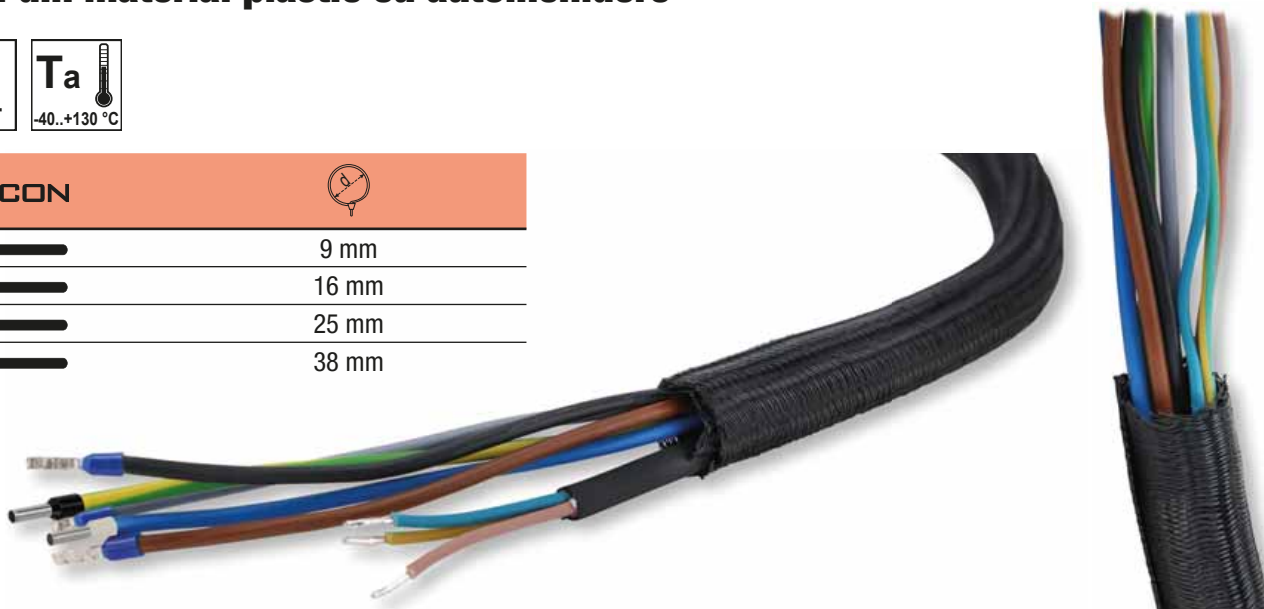

TRACON	
OFK9	9 mm
OFK16	16 mm
OFK25	25 mm
OFK38	38 mm



Sigilii de marcare

TRACON		L (mm)	a (mm)	b (mm)	
JPL1		230	18	54	80 N
JPL2		330	18	54	80 N
JPL3		415	21	79	200 N

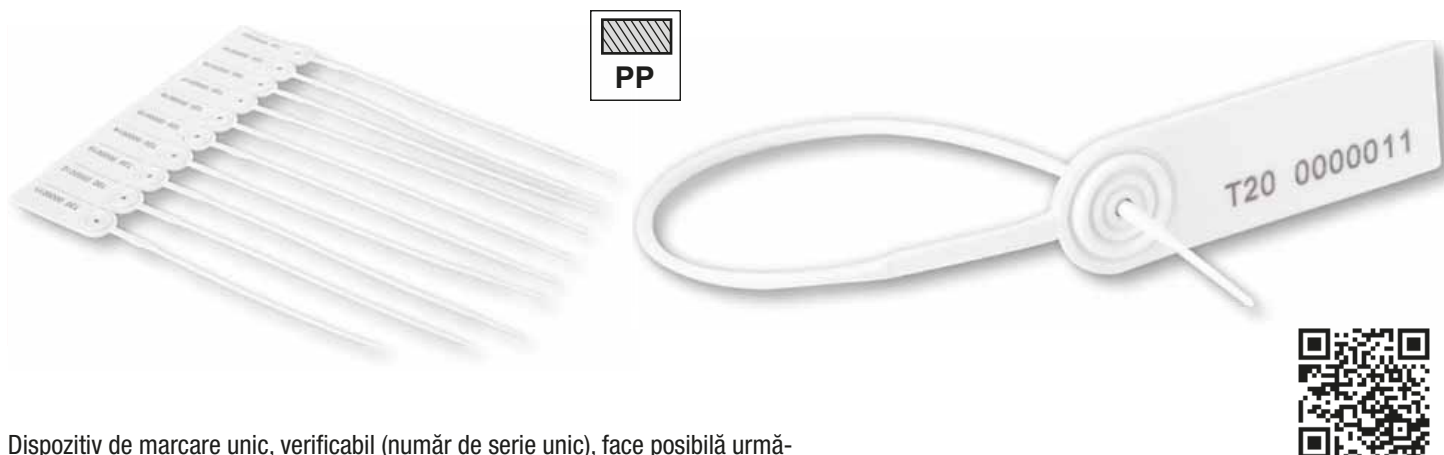

Dispozitiv de marcare unic, verificabil (număr de serie unic), face posibilă urmărirea accesului la obiectul protejat. Fixarea sigiliilor și eliminarea lor este foarte simplă, nu necesită unelte sau materiale auxiliare.

Capetele sigiliilor noastre sunt realizate cu inserții din metal sau plastic dur, deci nu se înmoaie la căldură, prin urmare este imposibilă deschiderea sigiliilor fără a le distruge.

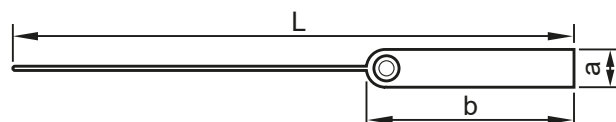

Sigilii pentru aparate de măsură

TRACON		a (mm)	b (mm)
MP1		30,5	21
MP2		27	13

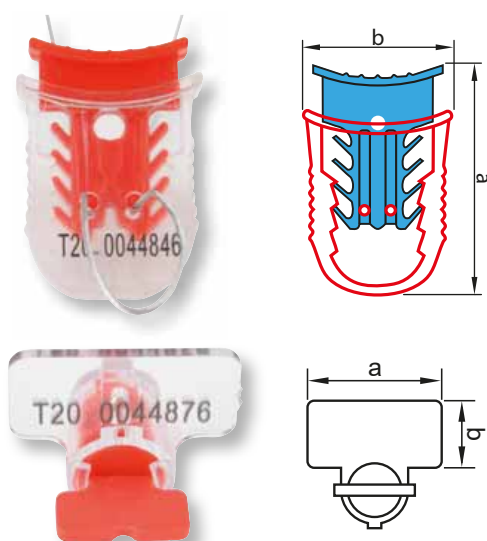

Sigiliile pentru aparatele de măsură sunt adecvate pentru dulapurile de distribuție, contoare de gaz și alte contoare pentru a furniza protecție simbolică. Se recomandă în orice loc unde scopul este închiderea simbolică, însă nu se dorește ca sigiliul să se rupă prematur. Pentru montare nu sunt necesare unelte sau materiale auxiliare.



CITIȚI CODUL !

- Vezi noutățile noastre
- Fiți informat

Gama de produse se dezvoltă continuu și rapid!
Catalogul nostru reflectă situația din Aprilie 2021.
Pentru informații actualizate vizitați pagina noastră de internet!

TRACON
.....ELECTRIC®

EVO

**FAMILIA DE PRODUSE
MODULARE EVO**



F/14-F/28