

INSTALLATION MANUAL

38145BR

ecolight



DARK LIGHT

80 CRI



230V | SMD 3030 | 40W | IP20 | Aluminium

Complete with 1000mA driver / Can be connected in line.

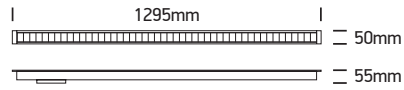
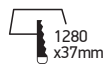

A INSTALLATION

Complete with:
4pcs fixing clips
4pcs connectors
2pcs end cups

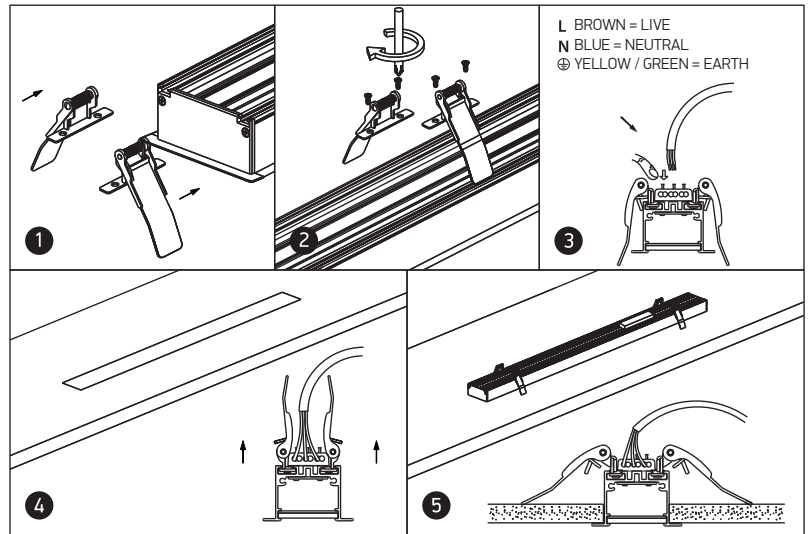
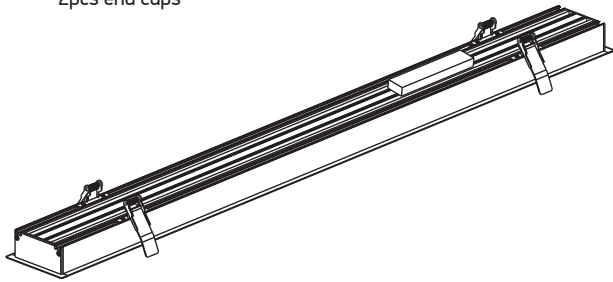

B CONNECTION

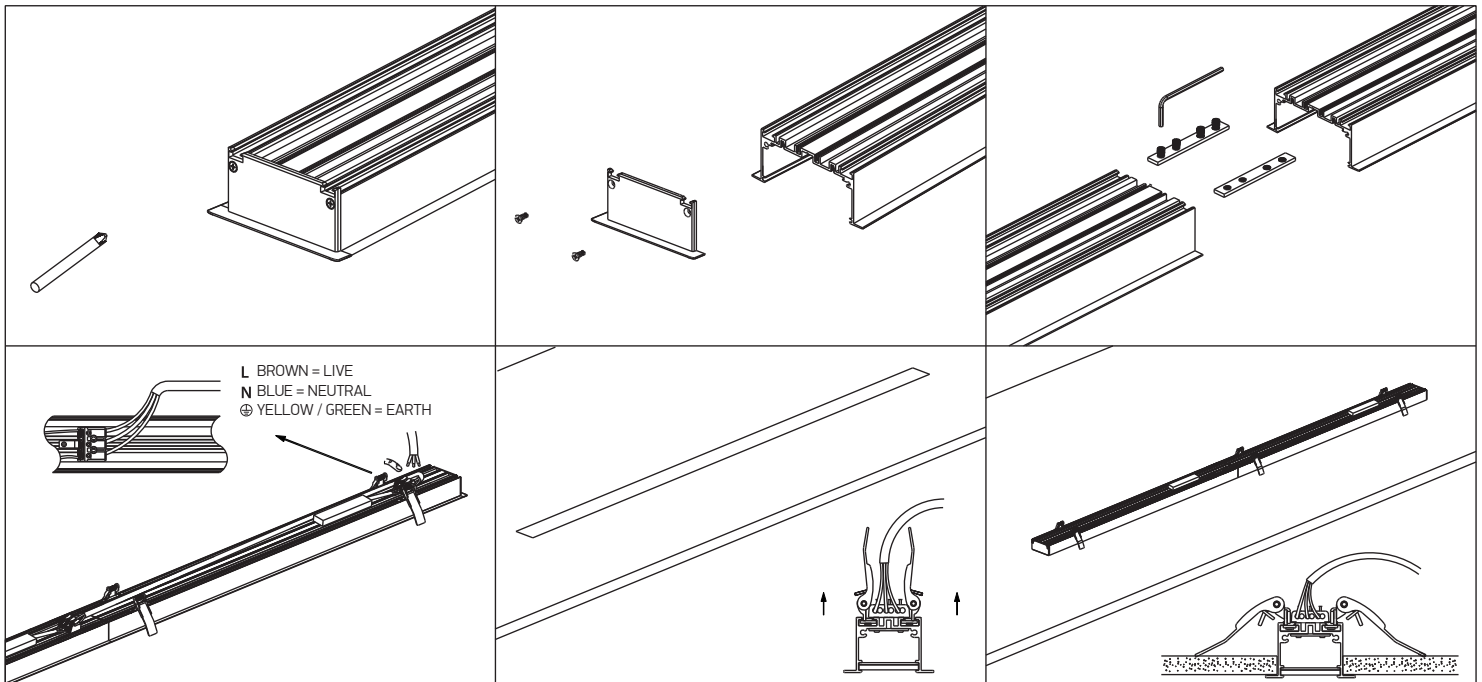

Warnings:

1. Make sure that the product is installed properly before connecting to electricity.
2. Do not cover the fitting.
3. Maintenance and installation should only be carried out by a professional electrician.