



Corpuri de iluminat LED pentru exterior, seria LHBP 6



Corp de iluminat pentru hale cu reglarea fluxului luminos 8



Corp de iluminat stradal, cu dispersor plan din sticlă 9



Proiectoare LED, seria RSMDB 12



Proiectoare LED, seria R-SMDP 13



Reflector LED, seria RHIS 14



Proiectoare LED, seria RSMDE 17



Proiectoare LED, seria RSMDL 18



Reflektoare LED portabile / pentru lucrări 20



Proector LED cu panou fotovoltaic și detector de mișcare 21



Lanterne LED 22



Lanterne frontale cu LED 24



Lanterne LED pentru bicicletă 25



Corpuri de iluminat incorporabile cu LED, rotunde 26

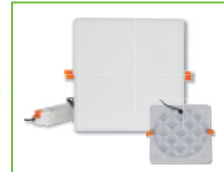

Corp de iluminat cu LED, incorporabil, protejat, pătrat 28



Corp de iluminat cu LED, rotund, pentru montare incastată și aparentă 29



Corp de iluminat incorporabil cu LED la care se poate modifica temperatura de culoare 30



Corpuri de iluminat TLC pentru surse spot 31



Panouri cu LED 33



Corp de iluminat LED cu reglarea fluxului luminos, care se poate suspenda 38



CL LED rotund, de perete, cu temperatură de culoare reglabilă 39



Corpuri de iluminat cu LED, seria MF (cu efect de cer instelat) 40



Aplice de perete LED, seria EVA 42



Corpuri de iluminat cu grad de protecție, cu sursă LED 47



Corpuri protejate pentru iluminat industrial cu LED-uri 49



CIL de sig-evacuare 53



Corpuri de siguranță-eva-cuare cu LED 54



Corpuri de iluminat cu LED pentru mobilă 55



Lămpi de birou cu LED 58



Corpuri de iluminat pentru exterior 62



Detectori infraroșii de mișcare 65



Detectori de mișcare tip radar 66



Senzori crepusculari 67







































MEAN WELL 68











































Module de comandă a fluxului luminos 72

Pictogramele capului de tabel

 Note, completări	 Curent primar	 Curent maxim în înfășurarea secundară	 Fluxul luminos (lumen)
 Temperatura de culoare (Kelvin)	 Putere nominală	 Tipul soclului	 Clasa de eficiență energetică
 Înlocuire bec incandescent clasic	 Înlocuire lămpi fluorescente compacte	 Numărul de LED-uri (buc)	 Înlocuire surse halogen
 Înlocuire tuburi fluorescente	 Curent nominal (A)	 Înlocuire halogenuri metalice	 Grad de protecție
 Autonomie (h)	 Numărul de cleme pentru prinderea dispersorului (buc)	 Înălțimea și diametrul stâlpului (mm)	 Randament
 Iluminarea (lux)	 Capacitatea electrică	 Culoarea dispersorului	 Dimensiuni (LxWxH)
 Dimensiunea decupării (mm)	 Contact de protecție lateral	 Unghi flux luminos (°)	 Culoare
 Înclinare corp de iluminat (°)	 Capacitatea acumulatorului (Ah)	 Tensiunea acumulatorului (V)	 Tipul acumulatorului
 Timp de încărcare	 Sonerie	 Sensor ON - OFF	 Focalizare reglabilă

Pictogramele datelor tehnice

 Tensiune nominală (V)	 Corp de iluminat potrivit pentru iluminat interior	 Corp de iluminat potrivit pentru iluminat interior și exterior	 Corp de iluminat potrivit pentru iluminat exterior
 Corpul de iluminat se poate monta pe tavan	 Corpul de iluminat se poate monta pe pereții laterali	 Corpul de iluminat se poate monta pe tavan și pe pereții laterali	 Corpul de iluminat se poate încadra în tavanul fals
 Frecvența nominală	 Secțiunea conductorului de racord	 Secțiunea cablului de racord	 Grad de protecție
 Cablul de racord	 Balast electromagnetic	 Tipul de LED	 Sursa de lumină nu se poate înlocui
 Durata de viață	 Temperatura mediului ambiant	 Domeniul de reglaj al temporizării	 Indicele de redare a culorii
 Nu pot fi comandate cu variatoare de flux luminos	 Numărul de cuplări	 Distanța minimă până la obiectul iluminat	 Unghi flux luminos
 Panou fotovoltaic	 Pot fi comandate cu variatoare de flux luminos	 Telecomandă	 Timpul de încălzire
 Iluminarea (lux)	 Sensor	 Tipul soclului	 Viteza de detecție
 Balast electronic	 Tipul soclului	 Corp de iluminat în clasa III de protecție la atingere	 Diametrul maxim al sursei de lumină
 Unghi de detecție	 Corp de iluminat în clasa II de protecție la atingere	 Transformator de siguranță	 Sistem activ de compensare a factorului de putere
 Corp de iluminat în clasa I de protecție la atingere			

Referință

Vă rugăm să consultați proiectele de referință pentru iluminat interior și exterior, pe care partenerii noștri le-au realizat prin utilizarea produselor Tracon.

Centrul Cultural Flesch Károly – Mosonmagyaróvár, Ungaria

Iluminat public – Mosonmagyaróvár, Ungaria

Hangar – Gyúró, Ungaria

Centru de sensibilizare și reutilizare – Budapesta, Ungaria

Grădinița – Szigetszentmiklós, Ungaria

Centrul Cultural – Kisvárdá, Ungaria

Raben Trans European – Dunaharaszti, Ungaria

Școala de dans BHG – Budapesta, Ungaria

Piața principală, pista de biciclete - Kápolnásnyék, Ungaria

Restaurant Gémeskút, Sukoró, Ungaria

Gallicoop, drumul Szarvas Ipartelep 531/1, Ungaria

Pioneer, Szarvas, Ungaria

Iluminat public – Halászi-Arak, Ungaria

Sala de badminton, Székesfehérvár, Ungaria

ML Produktion s.r.o., Knill Grupe – Myjava, Slovacia

Academia de științe a Slovaciei – Pozsony, Slovacia

Apartamente noi – Kassa, Slovacia

Instalație de compensare a puterii reactive – Nižný Hrušov, Slovacia

Magneti Marelli – Kassa, Slovacia

Atelier mecanic – Pivka, Slovenia

Spații de birouri – Ormož, Slovenia

Restaurant Prestige – Lazarevac, Serbia

Fabrica de lapte Somboled – Sombor, Serbia

Sala de lupte – Odorheiu Secuiesc, România

AEM – Timișoara, România

Alusystem – Timișoara, România

Hala Surub trade – Târgu Mureș, România

Salon Auto-Schunn - Timișoara, România

Centru sportiv, teren de tenis,

teren de fotbal și teren de squash – Čavle, Croația

Insula BRAČ - Case de vacanță – Sutivan, Croația

Molo Longo - terminal feribot trafic de călători – Rijeka, Croația

Iluminat public – Bjelovar, Croația

Iluminat public – Vinkovci, Croația

Ștrand municipal – Đakovo Gradski bazeni, Croația

Tipografie – Bielsko-Biala, Polonia

Uzina de prelucrare a lemnului Tartak FENIKS – Miasteczko Śląskie, Polonia

Cooperativa de horticultură și apicultură Silezia – Ruda Śląska, Polonia

Centru de prelucrare deșeuri – Katowice, Polonia

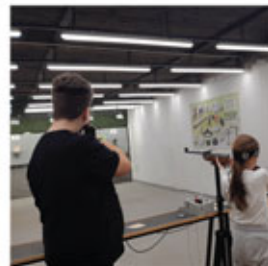
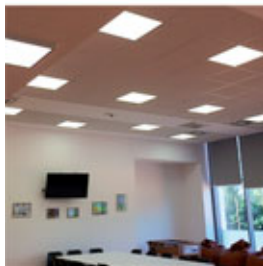



Proiecte de iluminat realizate în prealabil cu programul Relux

Putem ajuta munca partenerilor noștri prin realizarea în prealabil a proiectelor de iluminat pentru ca, corpurile Tracon utilizate în proiectare să asigure utilizatorilor o iluminare conform reglementărilor.

După verificarea corespunzătoare a datelor vă putem face o ofertă cu cantitatea și amplasarea corpurilor de iluminat alese, respectiv vă putem oferi și o soluție alternativă în cazul în care poate fi o alternativă adecvată pentru implementarea proiectului.

Proiectarea se poate realiza pentru iluminarea de hale industriale, birouri, săli de fitness, terenuri de sport, parcuri, depozite și de asemenea iluminat public.

Despre proiectele realizate vorbesc planurile de proiect anexate și referințele care se găsesc în meniul proiect!

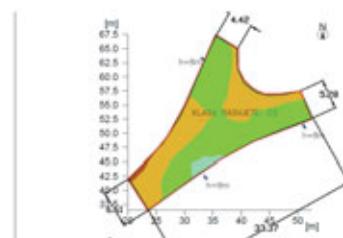
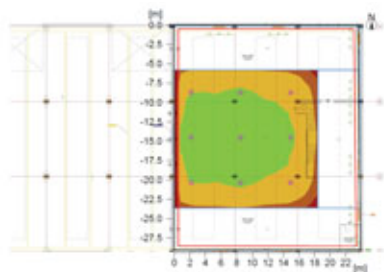
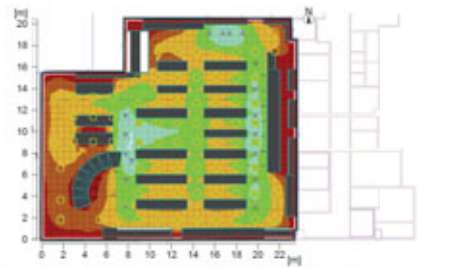
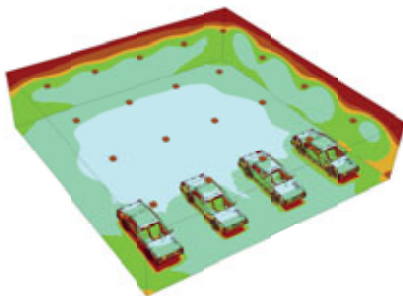
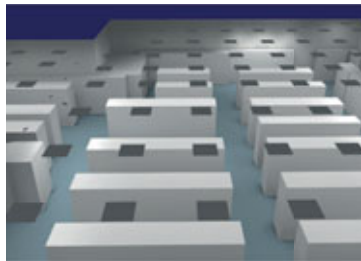
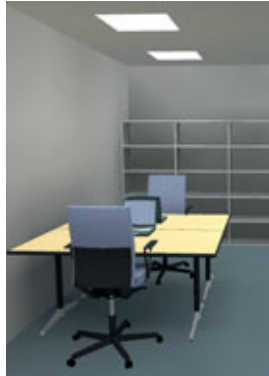

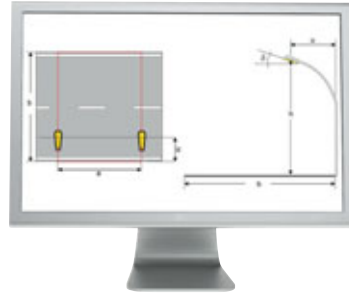
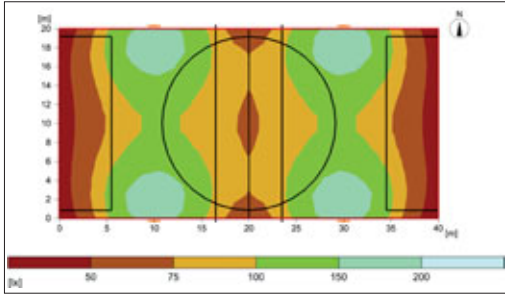
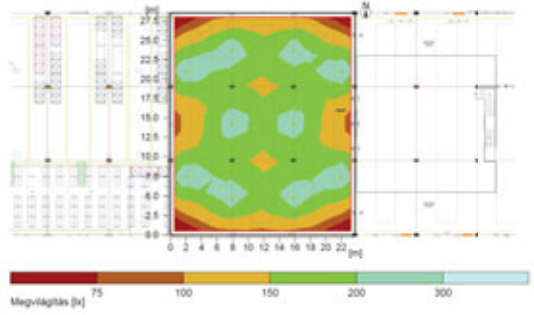
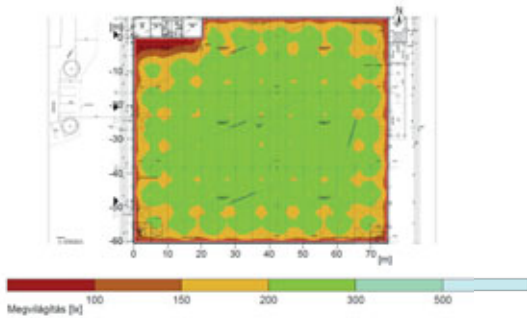

În scopul realizării mai facile a proiectelor de iluminat, se pot descărca din magazinul nostru virtual, fișierele cu date fotometrice în format IES ale corpurilor de iluminat profesionale cu LED pentru programele de proiectare utilizate în mod obișnuit (Dialux, Relux).

.ies

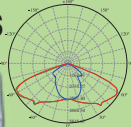

FURNIZORUL OFICIAL EON ȘI DÉMÁSZ ÎN UNGARIA

TRACON este furnizorul oficial pentru siguranțe automate al EON și DÉMÁSZ (rețeaua națională de utilități) în Ungaria!

TRACON
ELECTRIC®





În zilele noastre dezvoltarea tehnologiei LED a atins acel nivel încât iluminatul cu halogenuri metalice răspândit anterior să fie înlocuit cu un iluminat mai eficient, mai economic și ușor de controlat. Economia, ușor de calculat și perioada lungă de garanție asigură amortizarea costurilor de investiție mai ridicată. Corpurile de iluminat cu LED recomandate pentru înlocuirea corpurilor de iluminat cu halogenuri metalice asigură aceeași iluminare a planului de lucru.

Corpurile de iluminat stradale vândute în număr cel mai mare în lume sunt cele cu temperatura de culoare de 4.500 K pe care vi le recomandăm. Corpurile la care temperatura de culoare diferă de această valoare se livrează cu costuri suplimentare. La cerere corpurile de iluminat se pot livra cu surse de alimentare controlabile inteligente!

Cu corpurile de iluminat stradale cu LED se poate economisii în continuare energie electrică prin reglarea fluxului luminos și decuplarea lămpilor care nu se utilizează, respectiv comanda lor cu detectoare de mișcare sau de prezență.

Pentru toate corpurile de iluminat cu LED puteți găsi în magazinul nostru virtual datele tehnice individuale, detaliate care conțin curbele fotometrice, desenele cotate e.t.c.)



Corpuri de iluminat LED pentru exterior, seria LHBP



TRACON	(W)	LED	(lm)	Tc [K]	IP..	Ei
LHBP100W	100 W	250 W	9.000 lm	4.500 K	IP 65	A
LHBP160W	160 W	400 W	14.400 lm	4.500 K	IP 65	A
LHBP200W	200 W	500 W	18.000 lm	4.500 K	IP 65	A

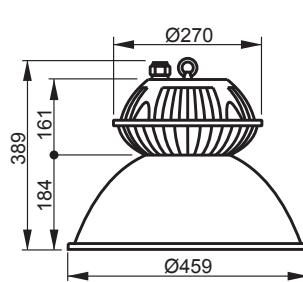

LHBP100W

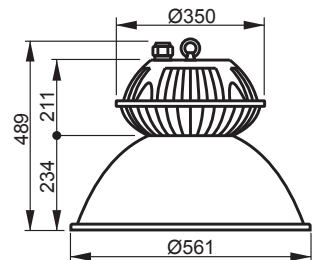

LHBP160W, LHBP200W



Corpuri de iluminat LED pentru exterior, seria LHBU



TRACON					IP..	D (mm)	H1 (mm)	H2 (mm)	H3 (mm)	
LHBU60W	60 W	150 W	7.200 lm	4.500 K	IP 65	256	48	92	110	A+
LHBU80W	80 W	200 W	9.700 lm	4.500 K	IP 65	256	48	92	110	A+
LHBU100W	100 W	250 W	13.000 lm	4.500 K	IP 65	320	66	132.5	170.5	A+
LHBU150W	150 W	400 W	19.500 lm	4.500 K	IP 65	320	66	132.5	170.5	A
LHBU200W	200 W	500 W	26.000 lm	4.500 K	IP 65	429	70	139	177	A

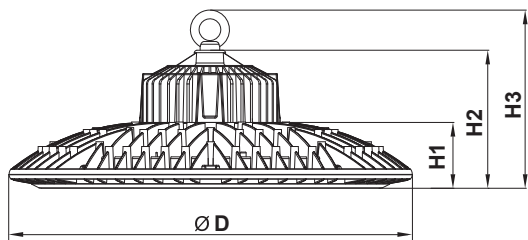

Corpuri de iluminat LED pentru exterior, seria LHBE



TRACON						D (mm)	H1 (mm)	H2 (mm)	
LHBE100W	100 W	250 W	8.000 lm	4.500 K	120°	280	31.5	73.1	A
LHBE150W	150 W	400 W	12.000 lm	4.500 K	120°	320	39	77.1	A
LHBE200W	200 W	500 W	16.000 lm	4.500 K	120°	360	51	94.2	A

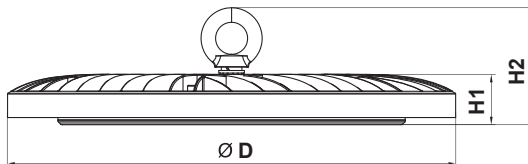

CITIȚI CODUL!

- Vezi noutățile noastre
- Fiți informat

Gama de produse se dezvoltă continuu și rapid!
Catalogul nostru reflectă situația din Aprilie 2019.
Pentru informații actualizate vizitați pagina
noastră de internet!

Corp de iluminat pentru hale cu reglarea fluxului luminos

90-265 V AC	50/60 Hz	[h] 50.000	≥ 75	ON-OFF >30.000					Ta $-20..+50^{\circ}\text{C}$	cos ϕ $>0,95$	IP 65
-----------------------	----------	---------------	-----------	----------------------------	--	--	--	--	--------------------------------------	---	--------------

TRACON			[lm]	[°]	Tc [K]		
LHBH90W	90 W	250 W	12.150 lm	130/40°	4.000 K	1 – 10 V	A+
LHBH150W	150 W	400 W	20.250 lm	130/40°	4.000 K	1 – 10 V	A+



5 YEARS WARRANTY



Curba fotometrică LHBH

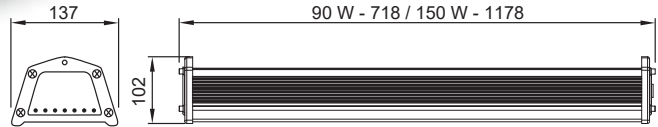
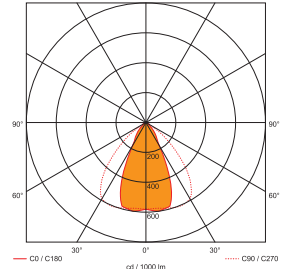

Corp de iluminat industrial cu LED, asociabil

230 V AC	50/60 Hz		[h] 50.000			≥ 80	Ta $-20..+50^{\circ}\text{C}$	SMD LED	120°	IP 42	max. 42 m		
--------------------	----------	--	---------------	--	--	-----------	--------------------------------------	----------------	------	--------------	------------------	--	--

TRACON			[lm]	Tc [K]	x LED	L x W x H (mm)	
ML0620NW	20 W	2x18 W	2.600 lm	4.000 K	144 x SMD2835	600x73x55	A+
ML1240NW	40 W	2x36 W	5.200 lm	4.000 K	288 x SMD2835	1200x73x55	A+
ML1560NW	60 W	2x58 W	7.800 lm	4.000 K	432 x SMD2835	1500x73x55	A+
MLC2	-	-	-	-	-	3 x 0.75 mm ² , 2 m	-



MLC2



3 YEARS WARRANTY

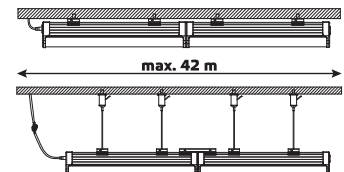

Corpuri cu LED pentru iluminat stradal, seria LSJA

100-240 V AC 50/60 Hz 50.000 [h] Ra ≥75 ON-OFF >30.000 Ta -20...+50°C cos φ >0,95 100 lm / Watt 4 kV 3x1,5mm² 50 cm RAL 7005

TRACON						L (mm)	W (mm)	B (mm)	φ (mm)	Ei
LSJA20W	1 × 20 W	50 W	2.000 lm	4.500 K	∅ 40 mm × 6 m	410	170	81	50	A+
LSJA30W	1 × 30 W	70 W	3.000 lm	4.500 K	∅ 50 mm × 6 m	500	214	81	50	A+
LSJA50W	1 × 50 W	120 W	5.000 lm	4.500 K	∅ 50 mm × 6 m	500	214	81	50	A+
LSJA60W	1 × 60 W	150 W	6.000 lm	4.500 K	∅ 50 mm × 6 m	500	214	81	50	A+
LSJA80W	1 × 80 W	200 W	8.000 lm	4.500 K	∅ 60 mm × 8 m	620	260	101	60	A+
LSJA100W	2 × 50 W	250 W	10.000 lm	4.500 K	∅ 60 mm × 8 m	700	280	112	65	A
LSJA120W	2 × 60 W	300 W	12.000 lm	4.500 K	∅ 60 mm × 8 m	700	280	112	65	A
LSJA150W	3 × 50 W	400 W	15.000 lm	4.500 K	∅ 60 mm × 12 m	880	340	122	65	A
LSJA180W	3 × 60 W	500 W	18.000 lm	4.500 K	∅ 60 mm × 12 m	880	340	122	65	A
LSJA200W	4 × 50 W	550 W	20.000 lm	4.500 K	∅ 73 mm × 12 m	1100	420	126	73	A
LSJA240W	4 × 60 W	600 W	24.000 lm	4.500 K	∅ 73 mm × 12 m	1100	420	126	73	A

Protecție la supratensiune cauzată de fulger pentru produsele din gama TTV2+3-10 (F/7)



5 YEARS WARRANTY

IP 65

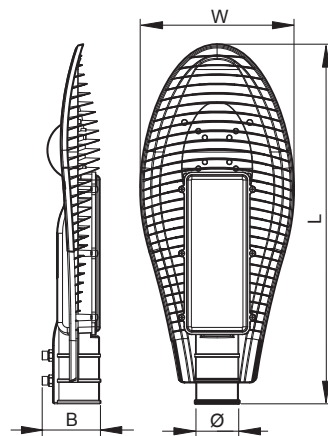

Familia de produse este adecvată pentru utilizarea în rețelele EON și ÉMÁSZ

Corpuri cu LED pentru iluminat stradal, seria LSJR

100-240 V AC 50/60 Hz 25.000 [h] Ra ≥75 ON-OFF >15.000 Ta -20...+50°C SMD LED 3x1,5mm² 30 cm IP 65 120°

TRACON						L x W x H (mm)	Ei
LSJR30W	30 W	50 W	2.400 lm	4.500 K	∅ 50 mm × 6 m	495×215×70	A
LSJR50W	50 W	100 W	4.000 lm	4.500 K	∅ 50 mm × 6 m	495×215×70	A
LSJR100W	100 W	200 W	8.000 lm	4.500 K	∅ 60 mm × 8 m	700×270×75	A



IP 65

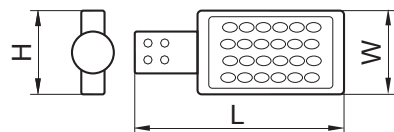

2 YEARS WARRANTY

Corp de iluminat stradal, seria LSJK

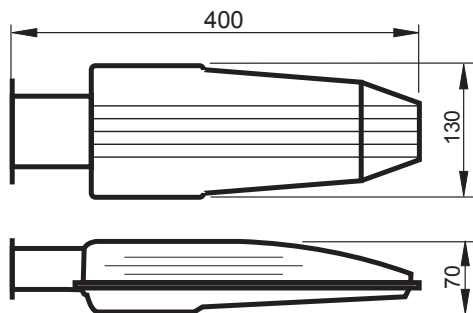

Accesorii

TRACON



LSJKAV	Adaptor corp de iluminat stradal LSJK pt. țevă orizontală, 50 mm
LSJKAF	Adaptor corp de iluminat stradal LSJK pt. țevă verticală, 50 mm
LSJAA	Adaptor de stâlp pentru corpurile de iluminat stradal LSJA30/50/60 și LSJR, 50-63 mm
LSJAA906050	Adaptor reglabil pentru corpuri de iluminat stradal, (0/90°) -10° - +20°, 50/60 mm
LSJAA906060	Adaptor reglabil pentru corpuri de iluminat stradal, (0/90°) -10° - +20°, 60/60 mm



LSJKAV



LSJKAF



LSJAA



LSJAA906050

LSJAA: Corpurile LSJA cu puterea 30-60W sunt fabricate pentru stâlpi cu diametrul de 50 mm. Prin utilizarea adaptorului LSJA, disponibil opțional aceste corpuri de iluminat se pot monta și pe stâlpi cu diametrul de 63 mm.

Nici un adaptor nu se poate utiliza pentru **LSJA20W**



CITIȚI CODUL!

- Vezi noutățile noastre
- Fiți informat

Gama de produse se dezvoltă continuu și rapid!
Catalogul nostru reflectă situația din Aprilie 2019.
Pentru informații actualizate vizitați pagina noastră de internet!

Proiectoare LED, seria RS MDB



TRAGON					L (mm)	W (mm)	H (mm)		
RS MDB10W	10 W	–	850 lm	4.500 K	198	160	45	120°	A
RS MDB20W	20 W	–	1.700 lm	4.500 K	198	160	45	120°	A
RS MDB30W	30 W	70 W	2.550 lm	4.500 K	320	220	61	120°	A
RS MDB50W	50 W	120 W	4.250 lm	4.500 K	320	220	61	120°	A
RS MDB80W	80 W	200 W	6.800 lm	4.500 K	357	320	68	120°	A
RS MDB100W	100 W	250 W	8.500 lm	4.500 K	357	320	68	120°	A
RS MDB120W	120 W	300 W	10.200 lm	4.500 K	450	360	76	120°	A
RS MDB150W	150 W	400 W	12.750 lm	4.500 K	450	360	76	120°	A

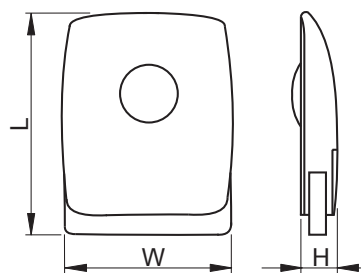

Proiector LED, seria R-SMDP

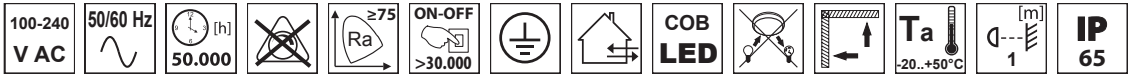

TRACON					L (mm)	W (mm)	H (mm)			
R-SMDP-50W	50 W	100 W	4.000 lm	4.500 K	323	242	79		120°	A
R-SMDP-80W	80 W	150 W	6.400 lm	4.500 K	323	242	79		120°	A
R-SMDP-100W	100 W	200 W	8.000 lm	4.500 K	461	381	129		120°	A
R-SMDP-200W	200 W	500 W	16.000 lm	4.500 K	630	470	165		120°	A
RSMDBA50W	50 W	100 W	4.000 lm	4.500 K	323	242	79		120°	A
RSMDBA100W	100 W	200 W	8.000 lm	4.500 K	461	381	129		120°	A

A: asimetric

SZ: simetric

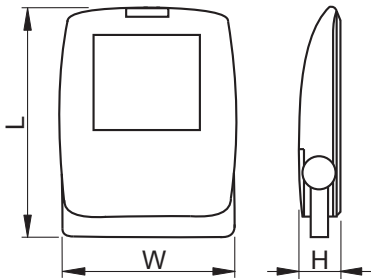

Manșon de cablu cu presetupe

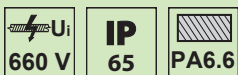

TRACON		
CST1	3 × 1	PG9
CST25	3 × 2,5	MG20



CST1

M/8

Cutie de manșonare cabluri

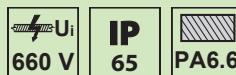

TRACON		
CSTBOX	3 × 1	PG9



M/8

Reflector LED, seria RHIS

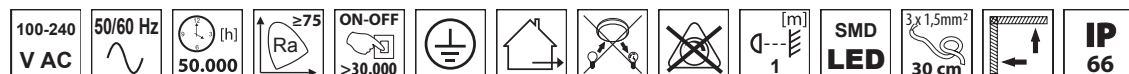

TRACON									
	[W]	LED	[lm]	[K]	(mm)	(mm)	(mm)	[°]	
RHIS100W	100 W	250 W	13.500 lm	4.000 K	413	366	83	120°	A+
RHIS150W	150 W	400 W	20.250 lm	4.000 K	413	366	83	120°	A+
RHIS240W	240 W	750 W	32.400 lm	4.000 K	462	452	87	120°	A+
RHISA100W	100 W	250 W	13.500 lm	4.000 K	413	366	83	-	A+
RHISA150W	150 W	400 W	20.250 lm	4.000 K	413	366	83	-	A+
RHISA240W	240 W	750 W	32.400 lm	4.000 K	462	452	87	-	A+
RHIS30100W	100 W	250 W	13.500 lm	4.000 K	413	366	83	30°	A+
RHIS30150W	150 W	400 W	20.250 lm	4.000 K	413	366	83	30°	A+
RHIS30240W	240 W	750 W	32.400 lm	4.000 K	462	452	87	30°	A+

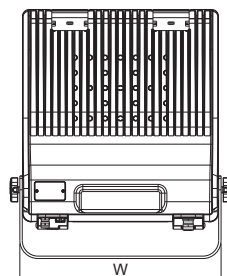
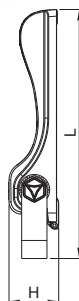

Curba fotometrică RHIS30

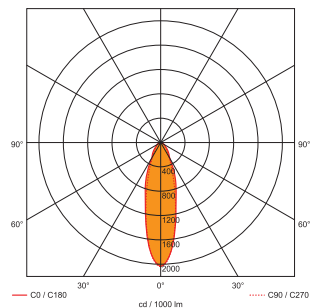

Curba fotometrică RHISA

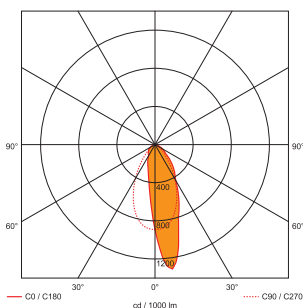

Curba fotometrică RHISS

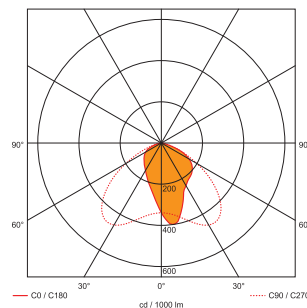

CITIȚI CODUL!

- Vezi noutățile noastre
- Fiți informat

Gama de produse se dezvoltă continuu și rapid!
 Catalogul nostru reflectă situația din Aprilie 2019.
 Pentru informații actualizate vizitați pagina noastră de internet!



IOS ANDROID

- Magazin virtual și catalog
- Promoții și promoții zilnice
- Căutare magazin, hartă
- Cititor de coduri QR și coduri de bare
- Informații actualizate

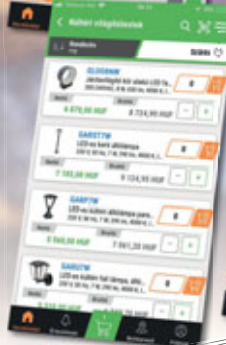
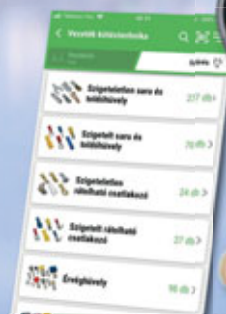

Proiector cu LED SMD



TRACON								
4500 K	4500 K	2700 K					L x W x H (mm)	
R-SMD-10W	R-SMDM-10W	R-SMD-10WW	10 W	70 W	700 lm	120°	115 x 90 x 86	A
R-SMD-20W	R-SMDM-20W	R-SMD-20WW	20 W	150 W	1.400 lm	120°	183 x 142 x 102	A
R-SMD-30W	R-SMDM-30W	R-SMD-30WW	30 W	250 W	2.100 lm	120°	227 x 188 x 128	A
R-SMD-50W	R-SMDM-50W	R-SMD-50WW	50 W	400 W	3.500 lm	120°	288 x 236 x 146	A



Proiector LED, seria RSMDS

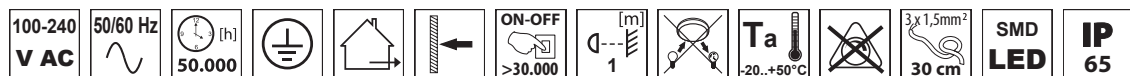

TRACON				Tc [K]		L x W x H (mm)	
RSMDS10W	10 W	70 W	800 lm	4.500 K	120°	165 x 143 x 52	A
RSMDS20W	20 W	150 W	1.600 lm	4.500 K	120°	211 x 190 x 62	A
RSMDS30W	30 W	250 W	2.400 lm	4.500 K	120°	238 x 205 x 68	A
RSMDS50W	50 W	400 W	4.000 lm	4.500 K	120°	282 x 245 x 72	A

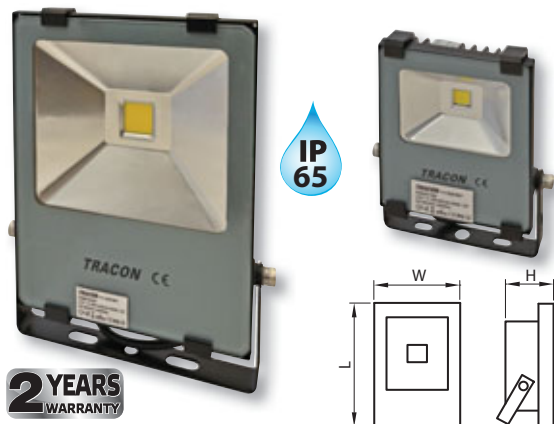

Proiectoare LED, seria RSMDE

120-240 V AC	50/60 Hz	[h] 25.000				ON-OFF >15.000	[m] 1		Ta -20..+50°C		3x 1,5mm ² 30 cm	SMD LED	IP 65
------------------------	----------	---------------	--	--	--	--------------------------	----------	--	-------------------------	--	--------------------------------	----------------	--------------

TRACON			[lm]	Tc [K]	[°]	L x W x H (mm)	
RSMDE10	10 W	70 W	680 lm	4.000 K	100°	115 x 83 x 19,8	A
RSMDE15	15 W	100 W	950 lm	4.000 K	100°	133 x 103 x 19,8	A
RSMDE24	24 W	170 W	1.580 lm	4.000 K	100°	165 x 146 x 25	A
RSMDE40	40 W	325 W	2.600 lm	4.000 K	100°	195 x 203 x 33	A

Legendă pictograme E1/O



2 YEARS WARRANTY

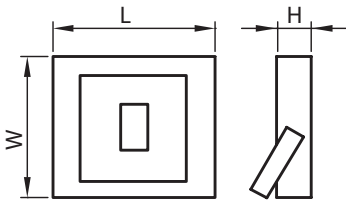

RSMDE40



RSMDE10

Proiectoare LED, seria RSMDJ

120-240 V AC	50/60 Hz	[h] 25.000				IP 65	SMD LED	[m] 0,5		Ta -20..+50°C	ON-OFF >15.000	3x 1,5mm ² 30 cm
------------------------	----------	---------------	--	--	--	--------------	----------------	------------	--	-------------------------	--------------------------	--------------------------------

TRACON			[lm]	Tc [K]	L x W x H (mm)	
RSMDJ10	10 W	70 W	800 lm	4.500 K	125 x 130 x 25	A
RSMDJ20	20 W	150 W	1.600 lm	4.500 K	175 x 190 x 35	A
RSMDJ30	30 W	250 W	2.400 lm	4.500 K	215 x 235 x 40	A
RSMDJ50	50 W	400 W	4.000 lm	4.500 K	245 x 270 x 45	A

Legendă pictograme E1/O



2 YEARS WARRANTY

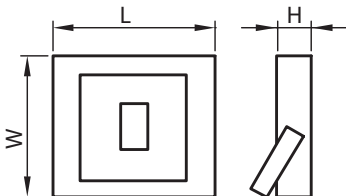

RSMDJ50



RSMDJ10

Proiectoare LED, seria RSMDJM

TRACON						
RSMDJM10	10 W	70 W	800 lm	4.500 K	185 × 130 × 25	A
RSMDJM20	20 W	150 W	1.600 lm	4.500 K	225 × 190 × 35	A
RSMDJM30	30 W	250 W	2.400 lm	4.500 K	255 × 235 × 40	A
RSMDJM50	50 W	400 W	4.000 lm	4.500 K	280 × 270 × 45	A



RSMDJM50



RSMDJM10

2 YEARS WARRANTY

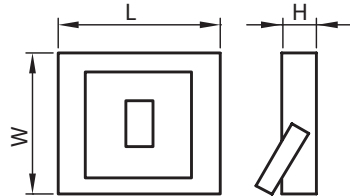
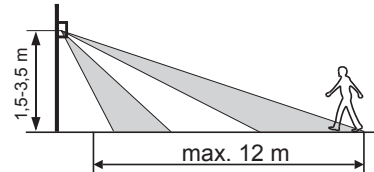

Proiectoare LED, seria RSMDL

TRACON						
RSMDL10	10 W	70 W	750 lm	4.000 K	105 × 75 × 55	A
RSMDL20	20 W	150 W	1.500 lm	4.000 K	136 × 95 × 55	A
RSMDL30	30 W	250 W	2.700 lm	4.000 K	170 × 120 × 65	A
RSMDL50	50 W	400 W	3.750 lm	4.000 K	203 × 142 × 65	A
RSMDL100	100 W	750 W	7.500 lm	4.000 K	334 × 229 × 76	A



RSMDL100

2 YEARS WARRANTY



RSMDL10

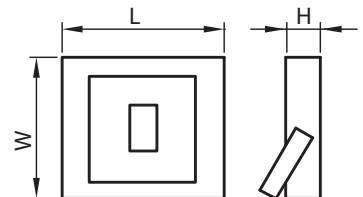

Proiector LED, seria RSMDLF

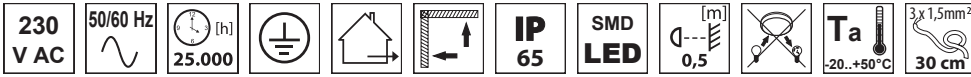

TRACON						
	[W]	LED	[lm]	Tc [K]	L x W x H (mm)	
RSMDLF10	10 W	70 W	750 lm	4.000 K	105 x 75 x 55	A
RSMDLF20	20 W	150 W	1.500 lm	4.000 K	136 x 95 x 55	A
RSMDLF30	30 W	250 W	2.700 lm	4.000 K	170 x 120 x 65	A
RSMDLF50	50 W	400 W	3.750 lm	4.000 K	203 x 142 x 65	A
RSMDLF100	100 W	750 W	7.500 lm	4.000 K	334 x 229 x 76	A

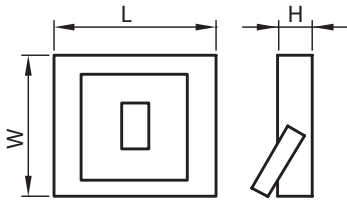

Proiector LED, seria RSMDLM



TRACON						
	[W]	LED	[lm]	Tc [K]	L x W x H (mm)	
RSMDLM10	10 W	70 W	750 lm	4.000 K	105 x 75 x 55	A
RSMDLM20	20 W	150 W	1.500 lm	4.000 K	136 x 95 x 55	A
RSMDLM30	30 W	250 W	2.700 lm	4.000 K	170 x 120 x 65	A
RSMDLM50	50 W	400 W	3.750 lm	4.000 K	203 x 142 x 65	A
RSMDLFM10	10 W	70 W	750 lm	4.000 K	105 x 75 x 55	A
RSMDLFM20	20 W	150 W	1.500 lm	4.000 K	136 x 95 x 55	A
RSMDLFM30	30 W	250 W	2.700 lm	4.000 K	170 x 120 x 65	A
RSMDLFM50	50 W	400 W	3.750 lm	4.000 K	203 x 142 x 65	A

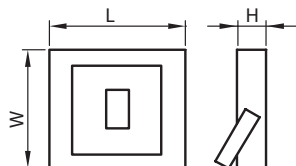
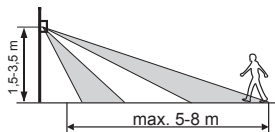

Reflectoare LED portabile / pentru lucrări

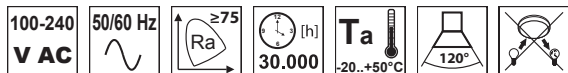

TRACON					T_c [K]	h (mm)			
RSMDAE10W	10 W	70 W	600 lm	4.500 K	–	4 h	3,7 V/4 Ah Li-Ion	A	
RSMDAE20W	20 W	150 W	1.200 lm	4.500 K	–	4 h	8,4 V/10 Ah Li-Ion	A	
RSMDAW30W	30 W	250 W	2.400 lm	4.000 K	–	–	–	A	
RSMDTRI10W	10 W	70 W	800 lm	4.000 K	–	2,5 h	3,7 V/4,4 Ah Li-Ion	A+	
RSMDAW220W	2x20 W	2x150 W	2x1.600 lm	4.000 K	800-1500	–	–	A	
RSMDAW230W	2x30 W	2x250 W	2x2.400 lm	4.000 K	800-1500	–	–	A	
RSMDALV	–	–	–	–	800-1500	–	–	–	

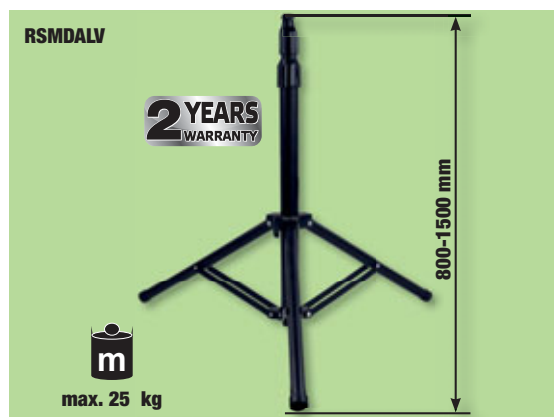
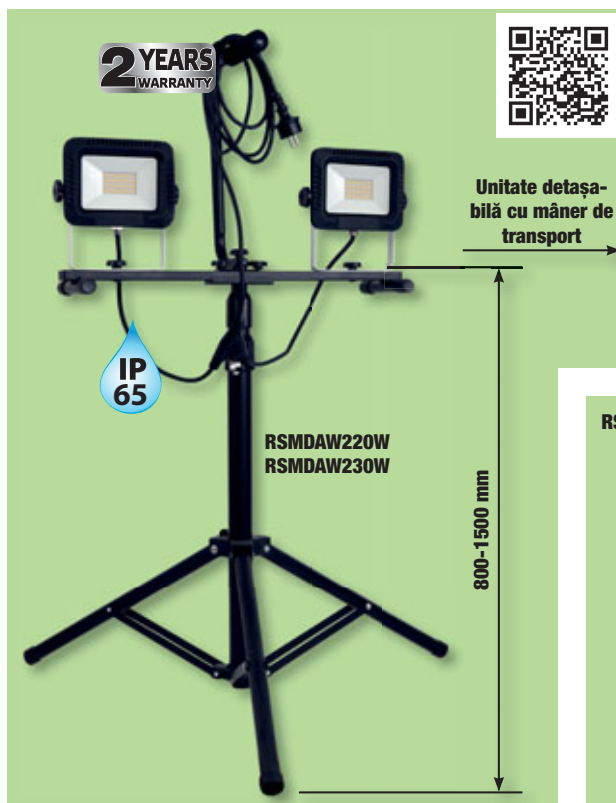

Proiector portabil cu LED - profesional



TRACON						<i>OUT</i>			
STLFL10W	10 W	70 W	1.000 lm	6.500 K	✓		3 h	3,7 V/4,4 Ah Li-Ion	A
STLFLBT15W	15 W	120 W	1.500 lm	6.000 K	✓		4-10 h	3,7 V/8 Ah Li-Ion	A











Proiector LED cu panou fotovoltaic și detector de mișcare



TRACON					<i>P_{max}</i>	<i>L × W × H (mm)</i>
LSFL5W	5 W	50 / 500 lm	4.000 K	3,7 V / 3 Ah Li-Ion	2,3 Wp	218×150×34











Lanterne LED

TRACON	 [W]	 [lm]	 Tc [K]	 [h]	 USB <i>IN</i>	 V	 USB <i>OUT</i>	
STLM4W	3/1 W	300/100 lm	6.000 K	3 h	✓	3,7 V/2,2 Ah Li-Ion	-	5 h
STLUSB2W	2 W	200 lm	6.000 K	3 h	✓	3,7 V/1,8 Ah Li-Ion	✓	3 h
STLE2W	2/0,5 W	200/100 lm	6.000 K	~ 4 h	-	3×1.5 V AAA	-	-
STLT2W	2/2 W	150/150 lm	6.000 K	3 h	✓	3,7 V/1,4 Ah, Li-Ion	-	4 h
STLE8W	8 W	800 lm	6.000 K	~ 10 h	-	3×1.5 V D	-	-
STLAL5W	5 W	200 lm	6.000 K	3 h	-	3,7 V/1,8 Ah Li-Ion	-	3,5 h



Lanterne LED

TRACON	 [W]	 [lm]	 Tc [K]	 [h]	 IN	 V	 OUT	
STLC5W	5/3 W	360/100 lm	6.000 K	4 h	✓	3,7 V/2000 mAh	-	3 h
STLHL5W	5/1 W	500/100 lm	6.500 K	3/12 h	-	3,7 V/4,4 Ah Li-Ion	-	4 h
STLHL10W	10/3 W	1.000/220 lm	6.500 K	3/9 h	-	3,7 V/6,6 Ah Li-Ion	-	4 h
STLCOB3W	3/3 W	100/180 lm	6.000 K	3,5 h	-	3,7 V/2 Ah Li-Ion	-	2,5 h
STLCAMP10W	10/4 W	600/200 lm	6.000 K	3/16 h	-	3,7 V/1,8 Ah Li-Ion/3×D+6×AAA	-	4 h
KL600B	4,5 W	500 lm	6.000 K	3 h	-	3,7 V/1,5 Ah Li-Ion	-	2 h

STLHL5W

2 YEARS WARRANTY

MAGNET



IP 54



STLHL10W

IP 54

MAGNET



2 YEARS WARRANTY



STLC5W

IP 44

2 YEARS WARRANTY

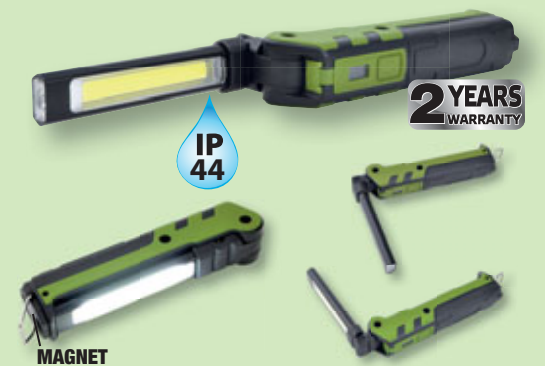

MAGNET

STLCOB3W

IP 44

2 YEARS WARRANTY

MAGNET



STLCAMP10W

IP 44



USB

2 YEARS WARRANTY



KL600B

2 YEARS WARRANTY

IP 54

STROBE

Lanterne frontale cu LED



TRACON							
HL500B	4,5 W	500	6.000 K	5 h	3,7 V/1,5 Ah Li-Po	-	✓
HL120B	3 W	120	6.000 K	5 h	3,7 V/1,2 Ah Li-Po	✓	-
HL120E	3 W	120	6.000 K	12 h	3xAAA 1,5 V	-	-



2 YEARS
WARRANTY



Lampă instalator



TRACON			
STL-02	-	8 W	A
STL-03	E27	60 W	A++, A+, A, B, C, D, E
STL-04	E27	60 W	B, C, D, E



STL-02
Lampă instalator cu
tub fluorescent



STL-03
Lampă instalator cu
protecție de metal



STL-04
Lampă instalator cu
protecție de
material plastic









CITIȚI CODUL!

- Vezi noutățile noastre
- Fiți informat

Gama de produse se dezvoltă continuu și rapid!
Catalogul nostru reflectă situația din Aprilie 2019.
Pentru informații actualizate vizitați pagina
noastră de internet!

Lanterne LED pentru bicicletă

TRACON						
BLCS3W	3 W	200 lm	6.000 K	~ 6/12 h	3,7 V / 1200 mAh Li-Ion	6/12 h
BLCE3W	3 W	250 lm	6.000 K	6/12 h	3×AAA 1,5 V	–
BLCA3W	3 W	250 lm	6.000 K	6/12 h	1200 mAh Li-Ion	6 h
BLCR2W	2 W	150 lm	5.000 K	2/5 h	3,7 V / 800 mAh	2,5 h

BLCS3W

2 YEARS WARRANTY



IP 64

- Panou fotovoltaic
- Acumulator

BLCE3W



IP 64

■ Cele 3 baterii AAA nu sunt incluse !!!

BLCA3W



IP 64

■ cu acumulator

BLCR2W



IP 54

■ cu iluminare față-spate

Lumină de veghe



100-240 V AC





IP 20

Legendă pictograme E1/0

TRACON		L x W x H D x H (mm)	
NL	1 W	55×115×70	–
NLS	1 W	55×115×70	–
NLUSB	1 W	90×70	1 A/2 A



Varianta de bază



Cu senzor crepuscular



Senzor crepuscular+prize USB

Corpuri de iluminat încorporabile cu LED, rotunde

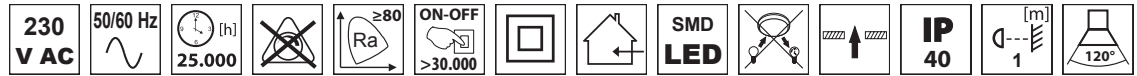

TRACON						D x H (mm)	Ei
LED-DL-6NW	6 W	1 x 13 W	390 lm	4.000 K	110 mm	120 x 20	A
LED-DL-12WW	12 W	1 x 26 W	850 lm	2.700 K	160 mm	174 x 20	A
LED-DL-12NW	12 W	1 x 26 W	850 lm	4.000 K	160 mm	174 x 20	A
LED-DL-18WW	18 W	2 x 26 W	1.300 lm	2.700 K	205 mm	225 x 20	A
LED-DL-18NW	18 W	2 x 26 W	1.300 lm	4.000 K	205 mm	225 x 20	A
LED-DLE-18NW	18 W	2 x 26 W	1.200 lm	4.000 K	205 mm	225 x 20	A

Corpurile de iluminat conțin balastul necesar alimentării de la rețea și de asemenea sursele de lumină cu LED.



Kit de urgență pentru panouri cu LED

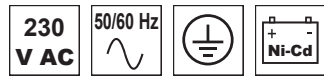

TRACON				
INV-DL-6	0.5 h	6 V	1.800 mAh	-
INV-DL-15	0.5 h	19.2 V	1.500 mAh	220x105x55 mm

Alimentator dimabil pentru corpuri de iluminat LED-DL..

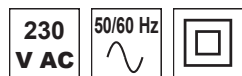

TRACON					
DLDD12W	230 VAC; 0,14 A	30-40 VDC; 300 mA	>85 %	Triac 3-100%	115x43x25 mm
DLDD18W	230 VAC; 0,21 A	30-40 VDC; 300 mA	>85 %	Triac 3-100%	115x43x25 mm

Corpuri de iluminat încorporabile cu LED, rotunde, cu grad de protecție

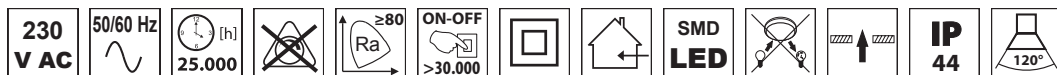

TRACON						D × H (mm)	
LED-DLV-6NW	6 W	1 × 13 W	390 lm	4.000 K	105 mm	Ø115 × 32	A
LED-DLV-12NW	12 W	1 × 26 W	840 lm	4.000 K	155 mm	Ø170 × 32	A
LED-DLV-18NW	18 W	2 × 26 W	1.450 lm	4.000 K	205 mm	Ø220 × 32	A

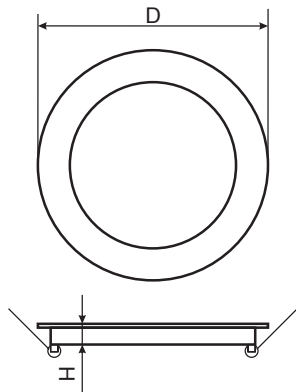

2 YEARS
WARRANTY

IP 44



Corpurile de iluminat conțin balastul necesar alimentării de la rețea și de asemenea sursele de lumină cu LED.

Corpuri de iluminat încorporabile cu LED, pătrate

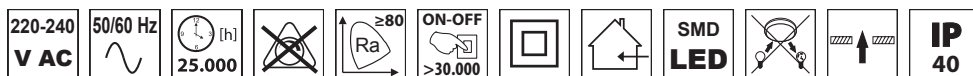

TRACON						D × H (mm)	
LED-DLN-6NW	6 W	1 × 13 W	400 lm	4.000 K	110 × 110 mm	120 × 120 × 20	A
LED-DLN-12NW	12 W	1 × 26 W	850 lm	4.000 K	160 × 160 mm	172 × 172 × 20	A
LED-DLN-18NW	18 W	2 × 26 W	1.300 lm	4.000 K	215 × 215 mm	225 × 225 × 20	A



2 YEARS
WARRANTY

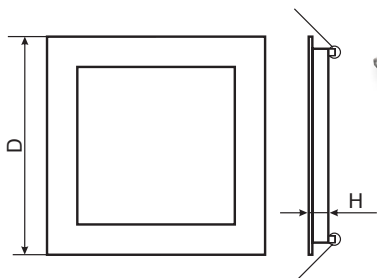

Corpurile de iluminat conțin balastul necesar alimentării de la rețea și de asemenea sursele de lumină cu LED.

Corp de iluminat cu LED, încorporabil, protejat, rotund

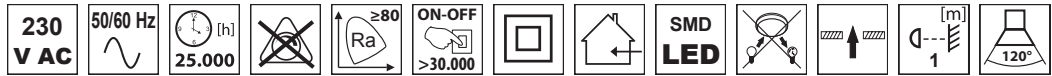

TRACON						D × H (mm)	
LED-DLIP-6NW	6 W	1 × 13 W	420 lm	4.000 K	55 mm	∅ 75 × 20	A+
LED-DLIP-10NW	10 W	1 × 26 W	800 lm	4.000 K	105 mm	∅ 125 × 20	A+
LED-DLIP-20NW	20 W	2 × 26 W	1.620 lm	4.000 K	165 mm	∅ 185 × 20	A+
LED-DLIP-28NW	28 W	3 × 26 W	2.250 lm	4.000 K	195 mm	∅ 215 × 20	A+

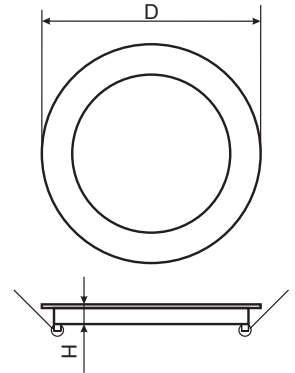

Corpurile de iluminat conțin balastul necesar alimentării de la rețea și de asemenea sursele de lumină cu LED.

Corp de iluminat cu LED, încorporabil, protejat, pătrat

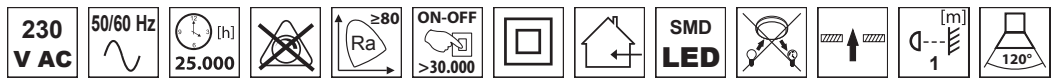

TRACON						L × W × H (mm)	
LED-DLIP-6NW	6 W	1 × 13 W	450 lm	4.000 K	55 × 55 mm	75 × 75 × 20	A+
LED-DLIP-10NW	10 W	1 × 26 W	920 lm	4.000 K	55 × 55 mm	125 × 125 × 20	A+
LED-DLIP-20NW	20 W	2 × 26 W	1.645 lm	4.000 K	165 × 165 mm	185 × 185 × 20	A+
LED-DLIP-28NW	28 W	3 × 26 W	2.340 lm	4.000 K	195 × 195 mm	215 × 215 × 20	A+

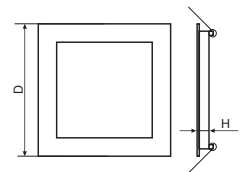

Corpurile de iluminat conțin balastul necesar alimentării de la rețea și de asemenea sursele de lumină cu LED.

Corp de iluminat cu LED, încorporabil, compact

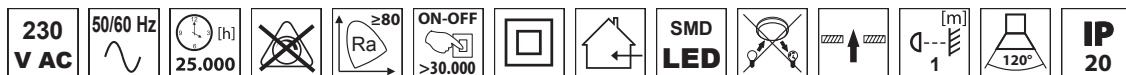

TRACON						D x H (mm)	
DLC2,5NW	2.5 W	1 x 13 W	220 lm	4.000 K	67 mm	∅ 92 x 40	A+
DLC5NW	5 W	1 x 13 W	450 lm	4.000 K	75 mm	∅ 104 x 40	A+
DLC12NW	12 W	1 x 26 W	1.050 lm	4.000 K	115 mm	∅ 148 x 50	A+
DLC24NW	24 W	2 x 26 W	2.100 lm	4.000 K	185 mm	∅ 225 x 50	A+

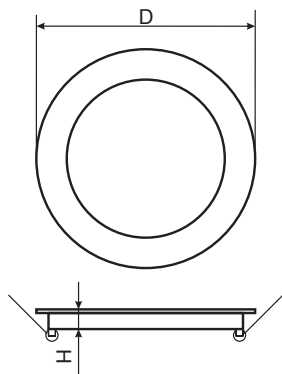

2 YEARS
WARRANTY



Corpurile de iluminat conțin balastul necesar alimentării de la rețea și de asemenea sursele de lumină cu LED.

Corp de iluminat cu LED, rotund, pentru montare încastată și aparentă



TRACON						L x W x H (mm)	
LEDDLU6NW	6 W	1 x 13 W	300 lm	4.000 K	95 mm	116 x 35	A
LEDDLU6WW	6 W	1 x 13 W	300 lm	2.700 K	95 mm	116 x 35	A
LEDDLU12NW	12 W	1 x 26 W	800 lm	4.000 K	150 mm	167 x 35	A
LEDDLU12WW	12 W	1 x 26 W	800 lm	2.700 K	150 mm	167 x 35	A
LEDDLU18NW	18 W	1 x 26 W	1.260 lm	4.000 K	200 mm	222 x 35	A
LEDDLU18WW	18 W	1 x 26 W	1.260 lm	2.700 K	200 mm	222 x 35	A

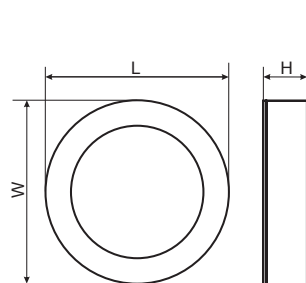

2 YEARS
WARRANTY



Corpurile de iluminat conțin balastul necesar alimentării de la rețea și de asemenea sursele de lumină cu LED.



Corp de iluminat încorporabil cu LED la care se poate modifica temperatura de culoare

230 V AC	50/60 Hz						SMD LED		
----------	----------	--	--	--	--	--	---------	--	--

TRACON							D × H (mm)	
DLETRIO9W	9 W	1 × 13 W	720 lm	3000/4000/6500 K	110°	95 mm	110 × 60	A+
DLETRIO14W	14 W	1 × 26 W	1.120 lm	3000/4000/6500 K	110°	120 mm	145 × 65,8	A+
DLETRIO18W	18 W	1 × 26 W	1.440 lm	3000/4000/6500 K	110°	150 mm	174 × 68,5	A+



Corpurile de iluminat conțin balastul necesar alimentării de la rețea și de asemenea sursele de lumină cu LED.

Corp de iluminat încorporabil cu LED la care se poate modifica temperatura de culoare

230 V AC	50/60 Hz						SMD LED		
----------	----------	--	--	--	--	--	---------	--	--

TRACON							D × H (mm)	
DLTRIO25W	25 W	2 × 32 W	2280/2650/2450 lm	3000/4000/5700 K	90°	205 mm	228 × 98	A

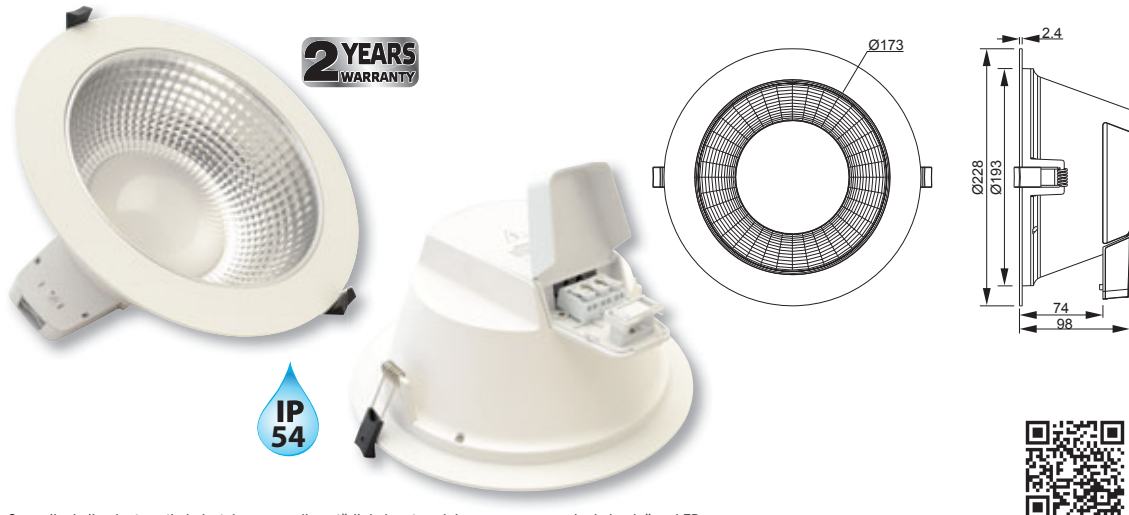

Corpurile de iluminat conțin balastul necesar alimentării de la rețea și de asemenea sursele de lumină cu LED.

Corpuri de iluminat TLC pentru surse spot



12 V AC/DC	50/60 Hz				IP 20	2 x 0,5mm 12 cm
	max. 50 W	Notă: Pentru sursele de lumină cu soclu GU10 la 230 V mai trebuie comandate adaptoare TAGU-10, Vezi pagina E2/21 !				

TRACON			
FIX	30°		
TLC-2C	TLC-6C		A++, A+, A, B, C, D, E
TLC-2MC	TLC-6MC		A++, A+, A, B, C, D, E
TLC-2MG	TLC-6MG		A++, A+, A, B, C, D, E
TLC-2MR	TLC-6MR		A++, A+, A, B, C, D, E
TLC-2W	TLC-6W		A++, A+, A, B, C, D, E

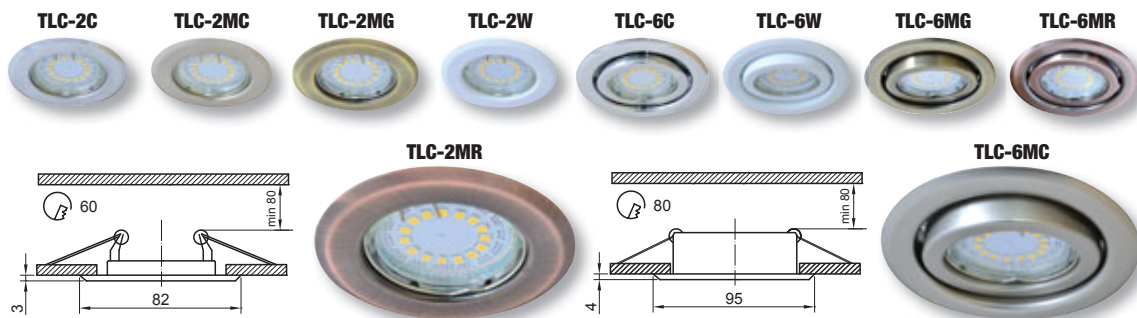

SONERII FĂRĂ FIR

TRACON
ELECTRIC®

- semnalare optică
- controlul volumului
- raza de acțiune 100 m
- 10 - 32 melodii
- grad de protecție IP 44



F/43



Corp de iluminat LED, încastrat, reglabil

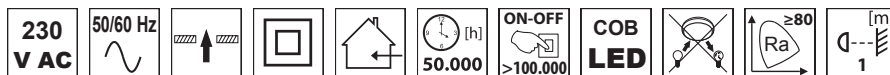

TRACON							D x H (mm)	IP..	
DLC0BA10W	10 W	20 W	800 lm	4.000 K	24°	87 mm	96 x 68		IP 40 A+
DLC0BA35W	35 W	70 W	3.500 lm	4.000 K	60°	165 mm	180 x 100		IP 40 A+
DLC0BA35WW	35 W	70 W	3.250 lm	2.700 K	60°	165 mm	180 x 100		IP 40 A+
DLC0BD5W*	5 W	10 W	510 lm	4.000 K	60°	68 mm	80 x 30		IP 65 A+
DLC0BD13W*	13 W	26 W	1.210 lm	4.000 K	60°	90 mm	110 x 49,5		IP 65 A+
DLNCOBD5W*	5 W	10 W	510 lm	4.000 K	60°	68 mm	80 x 30		IP 65 A+
DLNCOBD13W*	13 W	26 W	1.210 lm	4.000 K	60°	90 mm	110 x 49,5		IP 65 A+

* care pot fi comandate prin variatoare de flux luminos

Corpurile de iluminat conțin balastul necesar alimentării de la rețea și de asemenea sursele de lumină cu LED.

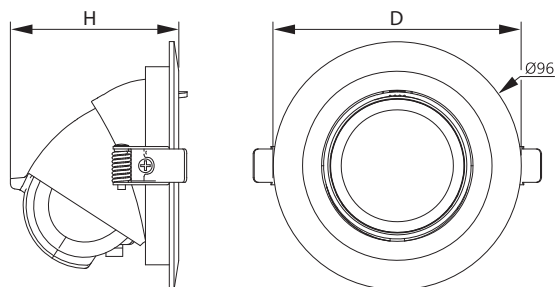

CITIȚI CODUL!

- Vezi noutățile noastre
- Fiți informat

Gama de produse se dezvoltă continuu și rapid!
Catalogul nostru reflectă situația din Aprilie 2019.
Pentru informații actualizate vizitați pagina noastră de internet!

Panouri cu LED



TRACON					L x W x H (mm)	
LP606040WW	40 W	4 x 18 W	2.900 lm	2.700 K	596 x 596 x 11	A
LP606040NW	40 W	4 x 18 W	2.900 lm	4.000 K	596 x 596 x 11	A
LPE606050NW	48 W	4 x 18 W	3.300 lm	4.000 K	596 x 596 x 11	A
LP3012040WW	40 W	2 x 36 W	2.900 lm	2.700 K	1.196 x 296 x 11	A
LP3012040NW	40 W	2 x 36 W	2.900 lm	4.000 K	1.196 x 296 x 11	A

Panourile cu LED se recomandă pentru iluminarea spațiilor publice, birourilor, atelierelor prevăzute cu tavan fals și se montează încastat. Panoul de 600x600 mm are exact mărimea unei casete, fiind adecvat pentru înlocuirea corpurilor de iluminat cu tuburi fluorescente 4x18 W. Panoul de 300x1200 mm cu lățimea de jumătate de casetă și cu lungimea de 2 casete se potrivește exact cu dimensiunile corpurilor de iluminat cu tuburi fluorescente 2x36 W; sunt ideale în primul rând pentru iluminarea coridoarelor. Completate cu unitatea **INV-DL-15** panourile pot fi operate opțional ca și corpuri pentru iluminatul de siguranță.

Opțional pentru proiecte sunt disponibile și seturi pentru montarea corpurilor pe tavan sau suspendate precum și variante constructive cu diferite date tehnice (diferite puteri, temperaturi de culoare, culoarea cadrului, dimensiuni, controlul fluxului luminos) care pot fi, de asemenea, comandate.

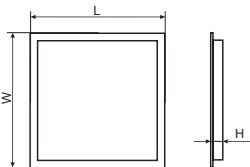

Cadru și panou posterior:

Panou frontal:

Culoarea cadrului panoului LED:

aluminiu

policarbonat

alb

2 YEARS
WARRANTY



Corpurile de iluminat conțin sursa de alimentare fără efect de pălpăire necesară alimentării de la rețea și de asemenea sursele LED.



Panouri cu LED



TRACON					L x W x H (mm)	
LP606040NWS	40 W	4 x 18 W	3.200 lm	4.000 K	596 x 596 x 9	A
LP606040WWS	40 W	4 x 18 W	3.100 lm	2.700 K	596 x 596 x 9	A
LP606050NWS	48 W	4 x 18 W	3.800 lm	4.000 K	596 x 596 x 9	A
LP606050WWS	48 W	4 x 18 W	3.700 lm	2.700 K	596 x 596 x 9	A
LP3012040NWS	40 W	2 x 36 W	3.200 lm	4.000 K	1.196 x 296 x 9	A
LP3012040WWS	40 W	2 x 36 W	3.100 lm	2.700 K	1.196 x 296 x 9	A



LP3012040..S



Panourile cu LED se recomandă pentru iluminarea spațiilor publice, birourilor, atelierelor prevăzute cu tavan fals și se montează încastat. Panoul de 600x600 mm are exact mărimea unei casete, fiind adecvat pentru înlocuirea corpurilor de iluminat cu tuburi fluorescente 4x18 W. Panoul de 300x1200 mm cu lățimea de jumătate de casetă și cu lungimea de 2 casete se potrivește exact cu dimensiunile corpurilor de iluminat cu tuburi fluorescente 2x36 W; sunt ideale în primul rând pentru iluminarea coridoarelor. Complețate cu unitatea **INV-DL-15** panourile pot fi operate opțional ca și corpuri pentru iluminatul de siguranță.

Opțional pentru proiecte sunt disponibile și seturi pentru montarea corpurilor pe tavan sau suspendate precum și variante constructive cu diferite date tehnice (diferite puteri, temperaturi de culoare, culoarea cadrului, dimensiuni, controlul fluxului luminos) care pot fi, de asemenea, comandate.

Corpurile de iluminat conțin sursa de alimentare fără efect de pălpăire necesară alimentării de la rețea și de asemenea sursele LED.

Cadru și panou posterior: aluminiu
Panou frontal: policarbonat
Culoarea cadrului panoului LED: alb

Cadru pentru montajul aparent a panourilor cu LED

TRACON		
LP6060K	LP606040NW, LP606040WW, LPE606050NW, LP606040NWS, LP606040WWS, LP606050NWS, LP606050WWS	
LP30120K	LP3012040NW, LP3012040WW, LP3012040NWS, LP3012040WWS	

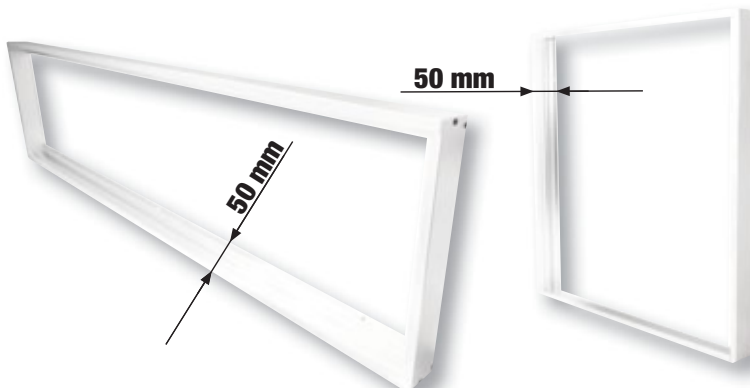

Cu acest accesoriu panourile cu LED pot fi montate și pe tencuială. Într-un panou și suprafața de montaj se pot utiliza surse de alimentare cu înălțimea de maxim 32 mm.

Material cadru: aluminiu, Culoare: albă



Set de suspensie pentru panouri cu LED

TRACON



600 x 600



300 x 1.200

LP606040F

LP6060....., LPE6060....., LP6060.....S, LP30120....., LP30120.....S

Lungime 1,5 metri

În cazul unor încăperi cu înălțime mare nu este necesară montarea unui tavan fals deoarece, cu acest accesoriu, panoul LED se poate monta mai jos cu 1,5m!

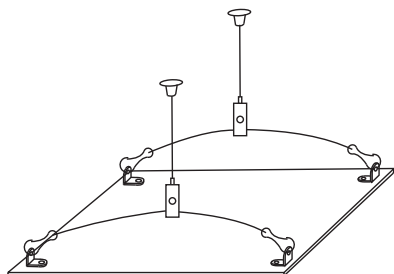

Alimentator cu reglarea fluxului luminos pentru panouri LED

TRACON	I_{pr}	I_{sec}	$\eta\%$	
LPCC40WD	200-240 VAC, 0,27 A	27-45 VDC, 950 mA	>90 %	Triaic, 8-100 %
LPCC48WD	200-240 VAC, 0,6 A	26-40 VDC, 1100 mA	>90 %	Triaic, 10-100 %
LPCC40W110D	100-240 VAC, 0,5 A	24-38 VDC, 1050 mA	>90 %	1-10 V, 8-100 %
LPCC48W110D	200-240 VAC, 0,5 A	26-42 VDC, 1100 mA	>90 %	1-10 V, 8-100 %

Dacă se utilizează acest tip de alimentator, fluxul luminos al panourilor cu LED poate fi modificat cu ajutorul unor dispozitive externe speciale (Triaic, 1-10 V).

2 YEARS
WARRANTY



Tehnica iluminatului sfaturi practice



O gamă largă de produse de tehnica iluminatului sunt disponibile partenerilor noștri în cazul unor investiții noi și renovări.

La alegerea produsului corespunzător solicitați ajutorul colegilor noștri pentru a vă oferi cea mai bună soluție pentru o anumită locație și aplicație.

Cleme pentru montajul încastat al panourilor LED



TRACON



600 x 600



300 x 1.200

LPC

x4

x6

Corpuri de iluminat cu LED, de perete, seria MFDS

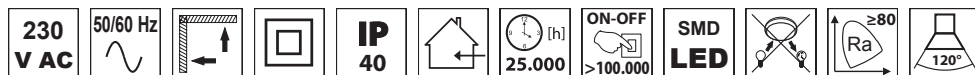

TRACON						
	[W]	LED	[lm]	[K]	D × H (mm)	
MFDS8W	8 W	75 W	600 lm	3.000 K	102 × 28	A
MFDS16W	16 W	150 W	1.200 lm	3.000 K	205 × 34	A

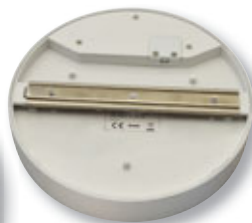

Corpurile de iluminat conțin balastul necesar alimentării de la rețea și de asemenea sursele de lumină cu LED.

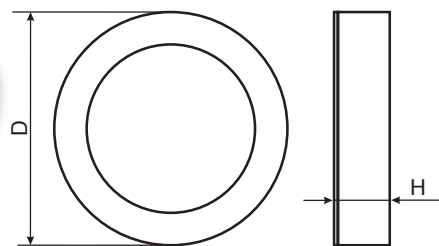

Corpuri de iluminat aparente cu LED, rotunde, seria LED-DLF

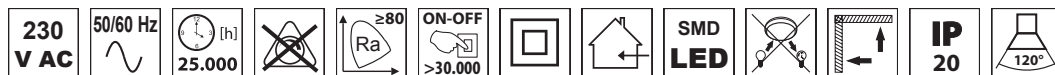

TRACON						
	[W]	LED	[lm]	[K]	D × H (mm)	
LED-DLF-6NW	6 W	1 × 13 W	330 lm	4.000 K	120 × 37	A
LED-DLF-12NW	12 W	1 × 26 W	800 lm	4.000 K	175 × 37	A
LED-DLF-18NW	18 W	2 × 26 W	1.200 lm	4.000 K	220 × 37	A
LED-DLF-18WW	18 W	2 × 26 W	1.200 lm	2.700 K	220 × 37	A
LED-DLF-28NW	28 W	3 × 26 W	1.800 lm	4.000 K	300 × 37	A
LED-DLF-28WW	28 W	3 × 26 W	1.800 lm	2.700 K	300 × 37	A

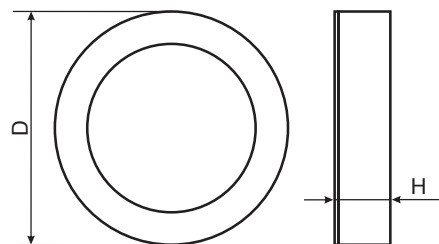

Corpurile de iluminat conțin balastul necesar alimentării de la rețea și de asemenea sursele de lumină cu LED.

CIL LED rotund de perete, seria MFU

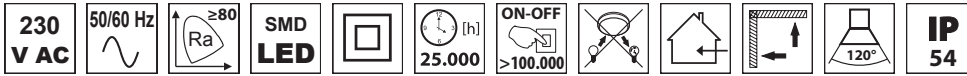

TRACON						
MFU30NW	30 W	250 W	2.750 lm	4.000 K	400 × 63	A+

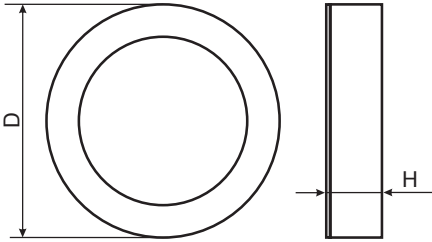

2 YEARS
WARRANTY



Corpurile de iluminat conțin balastul necesar alimentării de la rețea și de asemenea sursele de lumină cu LED.

Corpuri de iluminat cu LED, aparente, pătrate, seria LED-DLNF

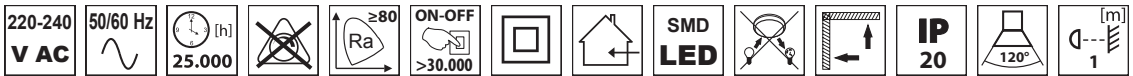

TRACON						
LED-DLNF-6NW	6 W	1 × 13 W	350 lm	4.000 K	120 × 120 × 39	A
LED-DLNF-12NW	12 W	1 × 26 W	800 lm	4.000 K	170 × 170 × 39	A
LED-DLNF-18NW	18 W	2 × 26 W	1.200 lm	4.000 K	225 × 225 × 39	A
LED-DLNF-28NW	28 W	3 × 26 W	1.900 lm	4.000 K	295 × 295 × 39	A

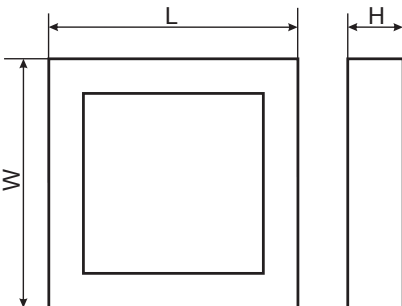

2 YEARS
WARRANTY



Corpurile de iluminat conțin balastul necesar alimentării de la rețea și de asemenea sursele de lumină cu LED.

Corp de iluminat LED cu reglarea fluxului luminos

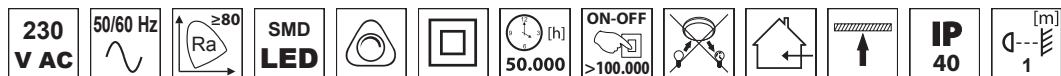

TRACON							D x H (mm)	
GLOMD25NW	25 W	150 W	1.900 lm	4.000 K	120°	298 x 50	A+	



2 YEARS WARRANTY

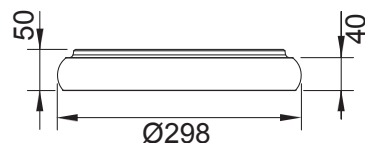

Corp de iluminat LED cu reglarea fluxului luminos, care se poate suspenda

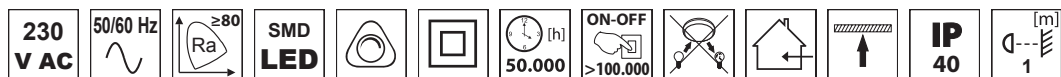

TRACON							D x H (mm)	
GLOFD25NW	25 W	150 W	1.900 lm	4.000 K	120°	298 x 50 / 1085	A+	



2 YEARS WARRANTY

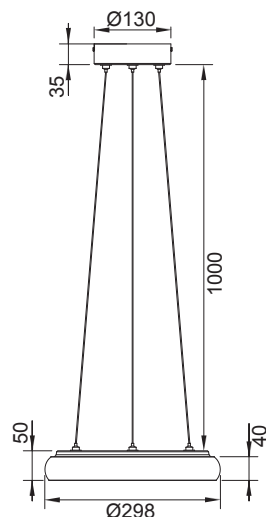

CIL LED rotund, de perete, cu temperatură de culoare reglabilă

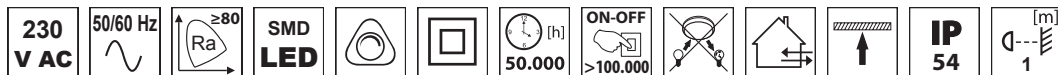

TRACON							
DLFTRIO18W	18 W	150 W	1440/1670/1530 lm	3000/4000/5700 K	90°	170 x 124	A+
DLFTRIO25W	25 W	200 W	2180/2530/2340 lm	3000/4000/5700 K	90°	213 x 129	A+

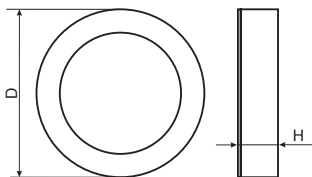

Corp LED, mat.plastic de perete, regl.temp.de culoare și flux



TRACON						
MF124W	24 W	150 W	1.500 lm	3.000-6.500 K	350x116	A

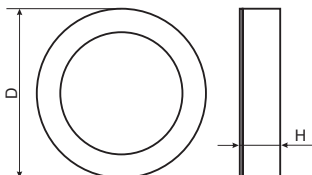

Corpuri de iluminat cu LED, seria MF (cu efect de cer înstelat)



TRACON					D x H (mm)	
MF12NW	12 W	75 W	720 lm	4.000 K	260 x 90	A
MF18NW	18 W	100 W	1080 lm	4.000 K	330 x 100	A
MF24NW	24 W	200 W	1440 lm	4.000 K	380 x 110	A



Corp de iluminat de tavan, cuLED, efect de cer înstelat



TRACON					D x H (mm)	
MFR60W	60 W	400 W	4.200 lm	3000-6500 K	480 x 110	A



Corpuri de iluminat cu LED, aparente, de tavan, seria LUF0



TRACON							
LUF0D12W	12 W	100 W	1110/1220/1190 lm	3000/4000/5700 K	120°	270 x 74	A+
LUF0D18W	18 W	150 W	1750/1870/1782 lm	3000/4000/5700 K	120°	320 x 74	A+
LUF0D25W	25 W	200 W	2450/2600/2500 lm	3000/4000/5700 K	120°	320 x 74	A+

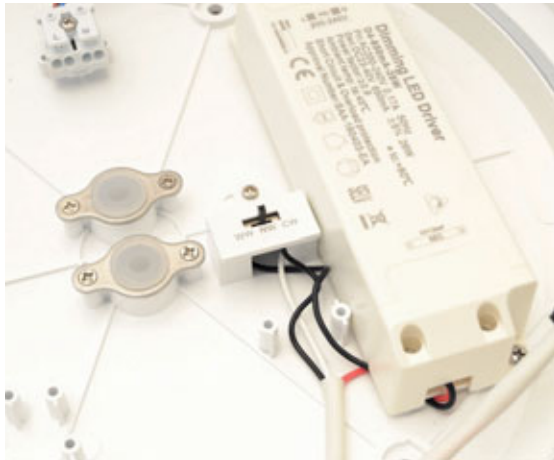

2 YEARS
WARRANTY



IP 65

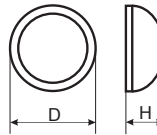

RELEE DE TIMP MODULARE **TRACON** ELECTRIC®



Familia de produse NAR

- Releu de timp cu temporizare la acționare
- Releu de timp cu temporizare la revenire
- Releu de timp multifuncțional
- Releu de supraveghere a tensiunii
- Releu de timp cu revenire fără tensiune de alimentare
- Automat de scară
- Releu de timp stea triunghi
- Releu de impuls

J/10-J/17



Aplice de perete LED, seria EVA



TRACON						D x H (mm)		
EVA14NW	14 W		72xSMD2835	1.000 lm	4.000 K	Ø305x84	-	A
EVA21NW	21 W	BASIC	108xSMD2835	1.600 lm	4.000 K	Ø400x96	-	A
EVA28NW	28 W		144xSMD2835	2.100 lm	4.000 K	Ø400x96	-	A
EVAS14NW	14 W		72xSMD2835	1.000 lm	4.000 K	Ø305x84	-	A
EVAS21NW	21 W		108xSMD2835	1.600 lm	4.000 K	Ø400x96	-	A
EVAS28NW	28 W		144xSMD2835	2.100 lm	4.000 K	Ø400x96	-	A
EVAE14NW	14 W / 2 W		72xSMD2835	1.000/140 lm	4.000 K	Ø305x84	1 h	A
EVAE21NW	21 W / 2 W		108xSMD2835	1.600/140 lm	4.000 K	Ø400x96	1 h	A
EVAE28NW	28 W / 2 W		144xSMD2835	2.100/140 lm	4.000 K	Ø400x96	1 h	A



2 YEARS
WARRANTY

EVA..

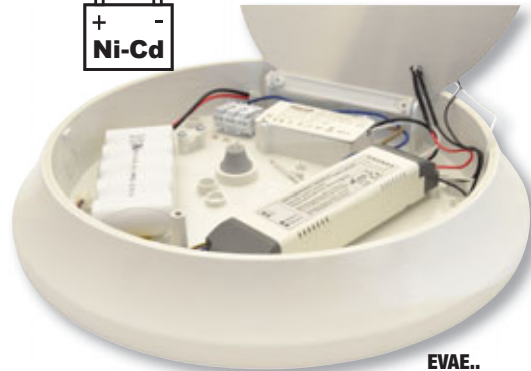
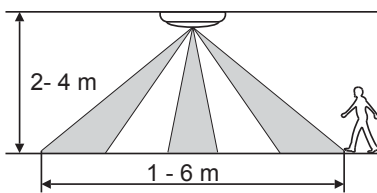

EVAE..

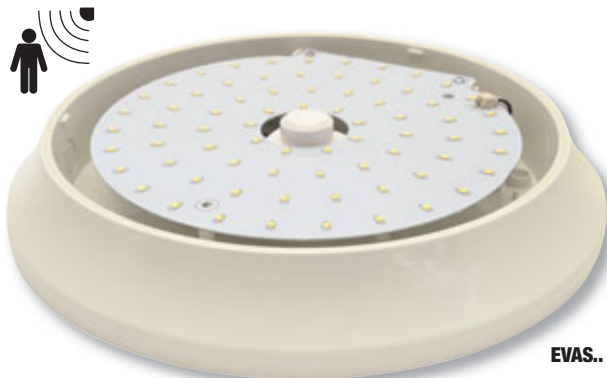

EVAS..

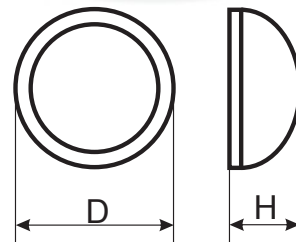

Aplice de perete LED, seria LFEK

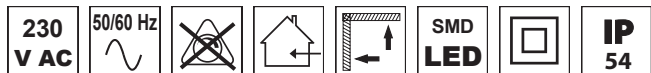

TRACON					D × H (mm)	Tc [K]	
LFEK6NW	6 W	60 W	420 lm	16×SMD5028	∅ 170×45	4.000 K	A
LFEK12NW	12 W	100 W	840 lm	32×SMD5028	∅ 230×45	4.000 K	A

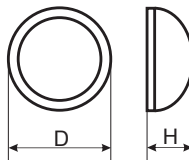

RELEVANT STANDARD
EN 60598



MERGEȚI LA SIGUR!

Gamă largă de produse

Calitate sigură

Recuplare automată ca opțiune

TRACON
ELECTRIC®

F/35

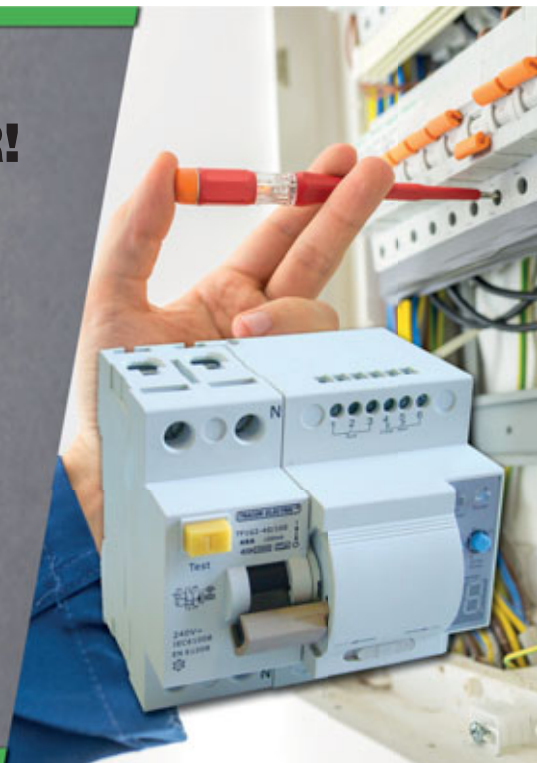

Aplice de perete LED, seria MF



TRACON					D x H (mm)	IP..	Tc [K]	
MF04	16 W	150 W	1.285 lm	96xSMD5028	∅ 296x75	IP 54	4.000 K	A
MF05	10 W	100 W	800 lm	24xSMD5028	∅ 275x117	IP 20	4.000 K	A

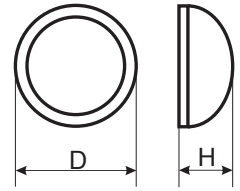

RELEVANT STANDARD
EN 60598

Corpuri de iluminat din material plastic, de perete, cu detector de mișcare

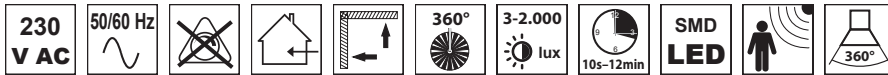

TRACON					D x H (mm)	IP..	
MFM01	1 x E27	max. 1 x 25 W	-	-	∅ 270 x 103	IP 20	A++, A+, A, B, C, D, E
MFM02	-	16 W	1.285 lm	81xSMD5028	∅ 300x112	IP 44	A
MFM04	-	16 W	1.285 lm	96xSMD5028	∅ 296x75	IP 54	A

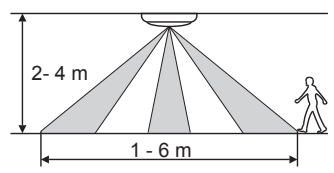
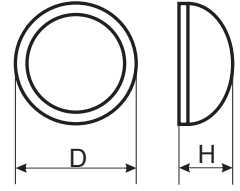

Corpuri de iluminat rotunde, de perete, din material plastic

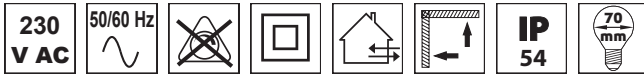

TRACON				D x H (mm)		
TLKVL-E27		E27	max. 60 W	Opal	∅ 270 × 100	A++, A+, A, B, C, D, E
TLKLV-E27		E27	max. 60 W	Transparent	∅ 270 × 100	A++, A+, A, B, C, D, E

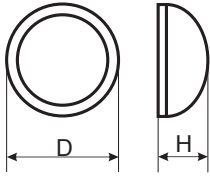

TLKVL-E27

TLKLV-E27

Corp de iluminat LED de perete, protejat, dispersor opal, alb

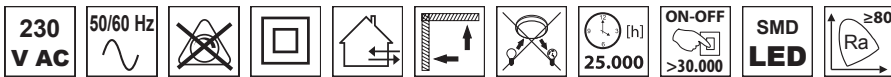

TRACON					D x H (mm)	IP..		
TLKVLED10NW	12 W	75 W	960 lm	Opal	∅ 270 × 100	IP 54	120°	A
TLKVLED24NW	24 W	200 W	1.920 lm	Opal	∅ 360 × 100	IP 54	120°	A

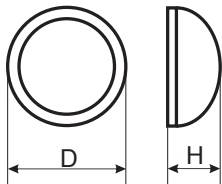

2 YEARS WARRANTY

IP 54



CITIȚI CODUL!

- Vezi noutățile noastre
- Fiți informat

Gama de produse se dezvoltă continuu și rapid!
 Catalogul nostru reflectă situația din Aprilie 2019.
 Pentru informații actualizate vizitați pagina
 noastră de internet!

Aplice de perete și de tavan

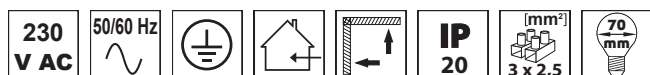

TRACON				D (mm)		
	UFO-1-B					
	UFO-1-F	1 × 60 W	1 × E27			
	UFO-1-K					
	UFO-1-Z					
	UFO-2-B					
	UFO-2-F	2 × 60 W	2 × E27	Ø 300		A++, A+, A, B, C, D, E
	UFO-2-K					
	UFO-2-Z					
	UFO-F-B					
	UFO-F-F	1 × 60 W	1 × E27			
	UFO-F-K					
	UFO-F-Z					

DOZE DE INSTALAȚII ELECTRICE

- Gamă largă de dimensiuni
- Cu șuruburi din material plastic
- Cu capac gri și transparent
- Cu intrări preștanțate de cablu

TRACON
ELECTRIC®

M/13

Corpuri de iluminat cu grad de protecție, cu sursă LED



TRACON					L x W x H D x H (mm)	
LHLM06NW	6 W	60 W	420 lm	4.000 K	165 x 116 x 70	A
LHLM012NW	12 W	100 W	840 lm	4.000 K	215 x 142 x 70	A
LHLMK6NW	6 W	60 W	420 lm	4.000 K	150 x 70	A
LHLMK12NW	12 W	100 W	840 lm	4.000 K	188 x 80	A
LHLMOS8NW	8 W	60 W	560 lm	4.000 K	168 x 100 x 58	A
LHLMOS15NW	15 W	100 W	1050 lm	4.000 K	221 x 131 x 68	A
LHLMKS8NW	8 W	60 W	560 lm	4.000 K	140 x 58	A
LHLMKS15NW	15 W	100 W	1050 lm	4.000 K	180 x 66	A



Corp de iluminat cu grad de protecție, deschidere cu mână



TRACON			L x W x H (mm)	
TLH-08S	E27	max. 60 W	180 x 125 x 110	A++, A+, A, B, C, D, E

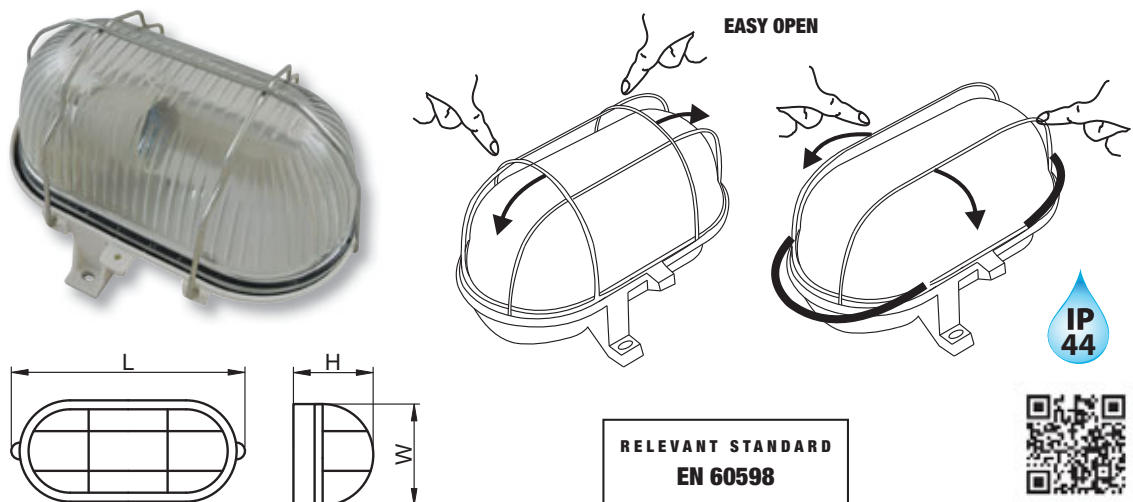

RELEVANT STANDARD
EN 60598

Corpuri protejate pentru iluminat industrial cu LED-uri



TRACON						L x W x H (mm)	
LVE0610W	10 W	18 W	900 lm	4.000 K	120°	715x53x35	A+
LVE0618W	18 W	2x18 W	1.600 lm	4.000 K	120°	715x53x35	A+
LVE1218W	18 W	36 W	1.600 lm	4.000 K	120°	1245x53x35	A+
LVE1236W	36 W	2x36 W	3.500 lm	4.000 K	120°	1245x53x35	A+
LVE1524W	24 W	58 W	2.160 lm	4.000 K	120°	1525x53x35	A+
LVE1545W	45 W	2x58 W	4.300 lm	4.000 K	120°	1525x53x35	A+

Produsul nu este asociabil !

2 YEARS
WARRANTY



IP 65

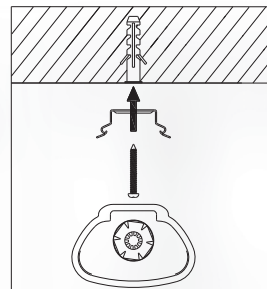
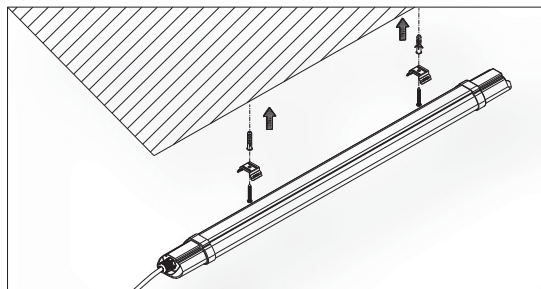
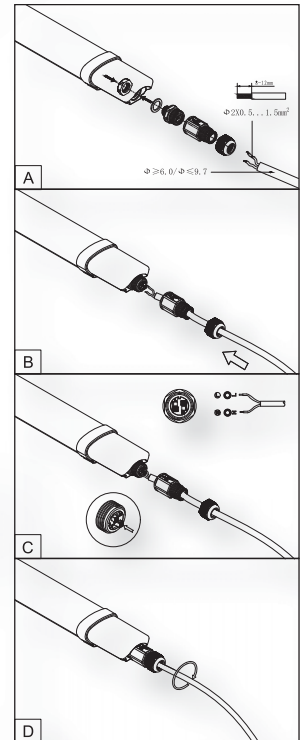

CITIȚI CODUL!

- Vezi noutățile noastre
- Fiți informat

Gama de produse se dezvoltă continuu și rapid!
Catalogul nostru reflectă situația din Aprilie 2019.
Pentru informații actualizate vizitați pagina noastră de internet!

Corpuri protejate pentru iluminat industrial cu LED-uri



TRACON						L x W x H (mm)		
LV0612	12 W	18 W		66 x SMD3528	1.000 lm	590 x 86 x 66	-	A
LV0618	18 W	2 x 18 W		92 x SMD3528	1.500 lm	590 x 86 x 66	-	A
LV1224	24 W	36 W		132 x SMD3528	2.000 lm	1180 x 86 x 66	-	A
LV1236	36 W	2 x 36 W	BASIC	184 x SMD3528	3.000 lm	1180 x 86 x 66	-	A
LV1530	30 W	58 W		168 x SMD3528	2.500 lm	1480 x 86 x 72	-	A
LV1548	48 W	2 x 58 W		252 x SMD3528	4.000 lm	1480 x 86 x 72	-	A
LV1556	56 W	2 x 58 W		288 x SMD3528	4.500 lm	1480 x 86 x 72	-	A
LV1224E	24 W / 3 W	36 W		132 x SMD3528	2.000/280 lm	1180 x 86 x 66	1 h	A
LV1236E	36 W / 3 W	2 x 36 W		184 x SMD3528	3.000/280 lm	1180 x 86 x 66	1 h	A
LV1530E	30 W / 3 W	58 W		168 x SMD3528	2.500/280 lm	1480 x 86 x 72	1 h	A
LV1548E	48 W / 4 W	2 x 58 W		252 x SMD3528	4.000/350 lm	1480 x 86 x 72	1 h	A
LV1236M	36 W	2 x 36 W		184 x SMD3528	3.000 lm	1180 x 86 x 66	-	A
LV1548M	48 W	2 x 58 W		252 x SMD3528	4.000 lm	1480 x 86 x 72	-	A

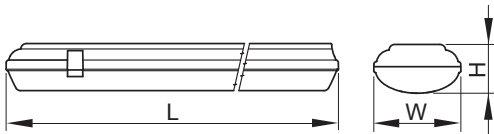

2 YEARS
WARRANTY



IP 65

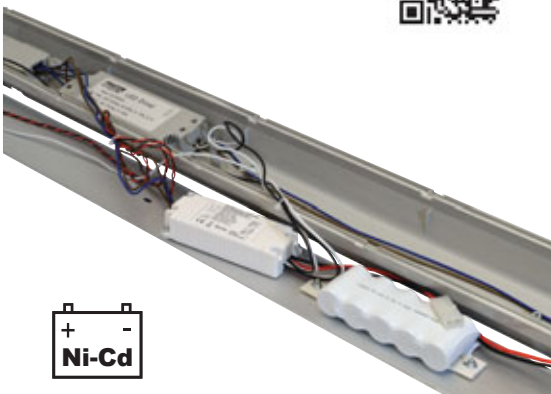

Ni-Cd

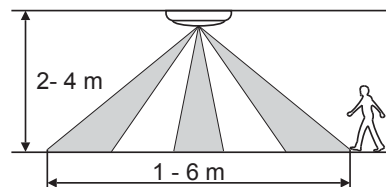

Corpuri de iluminat protejate pentru tuburi luminoase cu LED

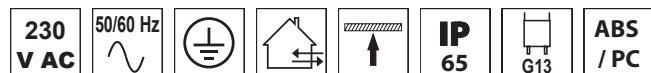

TRACON	LED			L x W x H (mm)	Ei
TLFVLED106	1 x 18 W	1 x 600 mm	x 6	655 x 72 x 86	A++, A+, A
TLFVLED112	1 x 36 W	1 x 1200 mm	x 10	1265 x 72 x 86	A++, A+, A
TLFVLED115	1 x 58 W	1 x 1500 mm	x 12	1565 x 72 x 86	A++, A+, A
TLFVLED206	2 x 18 W	2 x 600 mm	x 6	655 x 115 x 86	A++, A+, A
TLFVLED212	2 x 36 W	2 x 1200 mm	x 10	1265 x 130 x 92	A++, A+, A
TLFVLED215	2 x 58 W	2 x 1500 mm	x 12	1565 x 120 x 92	A++, A+, A

Corpurile de iluminat sunt cablate pentru tuburile LED alimentate la un capăt (LED-T8..., LT8G...), pentru tuburile LED alimentate la două capete este necesară recablarea corpului de iluminat pe baza instrucțiunilor de utilizare!

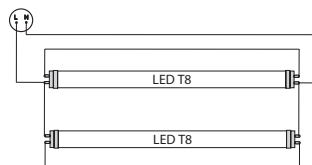

2 YEARS WARRANTY

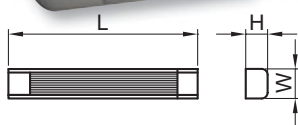

IP 65

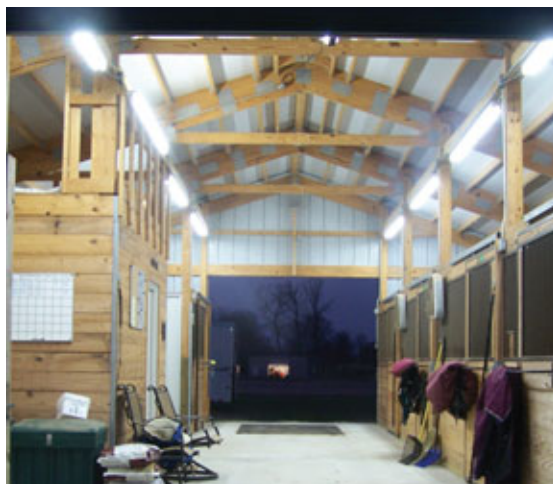

Kit de urgență pentru corpuri de iluminat



TRACON	T5	T8	[h]	v	Ah ⁺
INV-1418	14 W	18 W	1,5 h	3,6 V	2.400 mAh
INV-2836	28 W	36 W	1,5 h	4,8 V	2.400 mAh
INV-3558	35 W	58 W	1,5 h	6 V	2.400 mAh
INV-1418-15	14 W	18 W	0,5 h	3,6 V	1.500 mAh
INV-2836-15	28 W	36 W	0,5 h	4,8 V	1.500 mAh
INV-3558-15	35 W	58 W	0,5 h	6 V	1.500 mAh
INV-DL-6	** Pentru panouri LED până la 6-18 W		0,5 h	6 V	1.800 mAh
INV-DL-15	** Pentru panouri LED până la 50 W, vezi pag. E1/33, E1/34.		0,5 h	19,2 V	1.500 mAh



Încorporarea unităților complementare cu inverter în corpurile de iluminat cu tuburi fluorescente face posibilă ca la întreruperea tensiunii acestea să funcționeze ca și corp pentru iluminatul de siguranță.

Aceste unități sunt compuse din două părți. Inverterul asigură funcționarea sursei de lumină în cazul prezenței tensiunii, iar în lipsa tensiunii comută automat sursa de lumină pe acumulatorul încorporat. La revenirea tensiunii recuplarea se face tot automat.

Lămpi fluorescente industriale

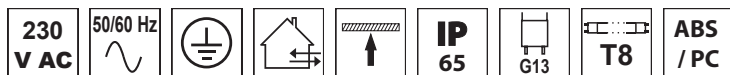

TRACON				
EVG			L x W x H (mm)	EI
TLFV-118E	1 x 18 W	6	655 x 72 x 86	A
TLFV-136E	1 x 36 W	10	1265 x 72 x 86	A
TLFV-158E	1 x 58 W	12	1565 x 72 x 86	A
TLFV-218E	2 x 18 W	6	655 x 115 x 86	A
TLFV-236E	2 x 36 W	10	1265 x 115 x 86	A
TLFV-258E	2 x 58 W	12	1565 x 115 x 86	A

TRACON				
VVG			L x W x H (mm)	EI
TLFV-118M	1 x 18 W	6	655 x 89 x 92	A
TLFV-136M	1 x 36 W	10	1265 x 89 x 92	A
TLFV-158M	1 x 58 W	12	1565 x 89 x 92	A
TLFV-218M	2 x 18 W	6	655 x 130 x 92	A
TLFV-236M	2 x 36 W	10	1265 x 130 x 92	A
TLFV-258M	2 x 58 W	12	1565 x 130 x 92	A

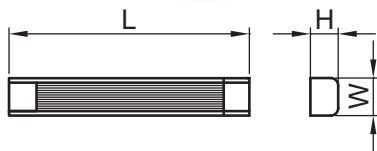

TLFV-BKZ



Balast electronic pentru corpuri de iluminat cu tub fluorescent T8



TRACON		L (mm)	W (mm)	H (mm)
TLFV-EE-118	1 x 18 W	275	28	27
TLFV-EE-136	1 x 36 W	275	28	27
TLFV-EE-158	1 x 58 W	320	32	28
TLFV-EE-218	2 x 18 W	275	28	27
TLFV-EE-236	2 x 36 W	320	32	28
TLFV-EE-258	2 x 58 W	320	32	28
TLFV-EE-418	4 x 18 W	332	33	28

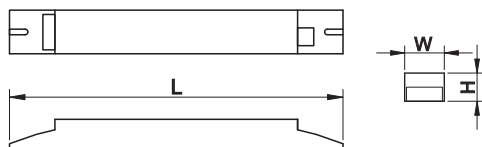

Corp de iluminat pentru tablă în sălile de clasă, asimetric

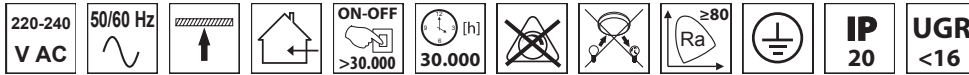

TRACON						L x W x H (mm)	
LTV45W	45 W	1x58 W	3600 lm	5000 K	110°	1500x100x113	A+



Corp de iluminat deschis pentru tuburi luminoase T8 cu LED



TRACON			L x W x H (mm)	
ELV109	1x9 W	600 mm	610x34x44,5	A, A+, A++
ELV209	2x9 W	600 mm	617x72x51	A, A+, A++
ELV118	1x18 W	1200 mm	1220x34x44,5	A, A+, A++
ELV218	2x18 W	1200 mm	1227x72x51	A, A+, A++

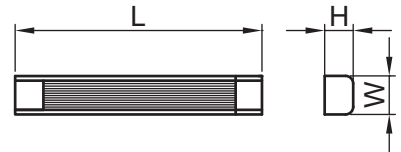
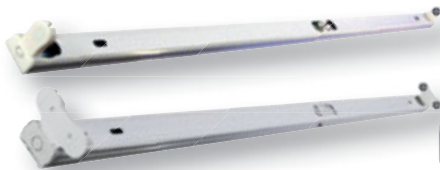

CIL de siguranță evacuare cu LED, lentile interschimbabile

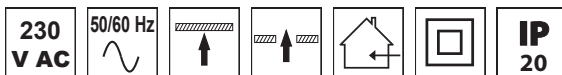

TRACON							D x H (mm)		
TLBVM3W	3 W	3 h	150 lm	4.8 V	900 mAh	Ni-Cd	134x45	NM	A

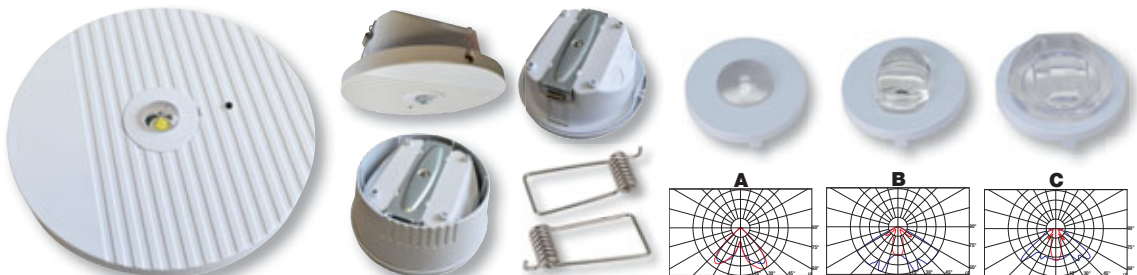

CIL de sig-evacuare



TRACON							L x W x H (mm)		
TLBV-18A	8 W	G5 (T5)	1 h	2.4 V	1.5 Ah	Ni-Cd	350x117x76	M	A
TLBV-18M	8 W	G5 (T5)	3 h	2.4 V	4.5 Ah	Ni-Cd	350x117x76	M	A
TLBV-18NM	8 W	G5 (T5)	3 h	2.4 V	4.5 Ah	Ni-Cd	350x117x76	NM	A
TLBVLED30NM	4 W	28xLED	3 h	3.6 V	1.800 mAh	Ni-Cd	345x110x60	M/NM	A



Setul de autocolante este inclus !

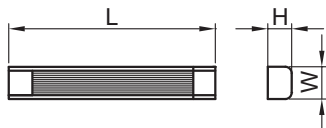

TLBV-18..

TLBVLED30NM



Asigură iluminarea căilor de evacuare în cazul deranjamentelor din rețeaua de alimentare normală. Corpurile de regim **permanent (M)** la întreruperea tensiunii rețelei de alimentare după timpul de comutare scurt rămân în continuare funcționale.

Cele de regim **nepermanent (NM)** funcționează doar în cazul întreruperii tensiunii rețelei de alimentare. Timpul de comutare este mai mic de 1 secundă.

Accesorii

TRACON	
TLBV-18-KJ	Placă înclinetabilă pentru indicarea căilor de evacuare la montajul pe tavan a corpurilor TLBV-18..., săgeată în lateral
TLBV-18-KL	Placă înclinetabilă pentru indicarea căilor de evacuare la montajul pe tavan a corpurilor TLBV-18..., săgeată în jos
TLBVLED30NM-K	Cadru încastrabil pentru corp de iluminat TLBVLED30NM
TLBVLED30NM-KJ	Placă pentru indicarea căilor de evacuare la montajul pe tavan a corpurilor TLBVLED30NM, săgeata se poate orienta



TLBV-18-KJ



TLBVLED30NM-KJ



TLBV-18-KL

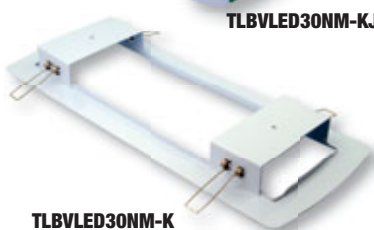

TLBVLED30NM-K

Setul de autocolante este inclus !

Corpuri de siguranță-evacuare cu LED



TRAGON									L (mm)	W ₁ (mm)	W ₂ (mm)	H (mm)	
EXIT-01-J	4 W	3 h	240 lm	× 13	M	2.4 V	900 mAh	Ni-Cd	350	60	160	30	A
EXIT-02-J	3 W	3 h	180 lm	× 8	M	2.4 V	900 mAh	Ni-Cd	240	60	150	25	A
EXIT-03-J	6 W	3 h	360 lm	× 18	M	3.6 V	900 mAh	Ni-Cd	340	25	160	65	A

Corpurile de regim permanent (M) la întreruperea tensiunii rețelei de alimentare după timpul de comutare scurt rămân în continuare funcționale.

Setul de autocolante este inclus !

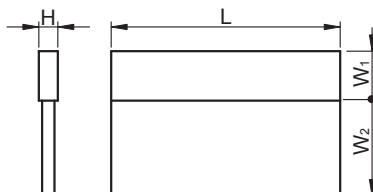

2 YEARS
WARRANTY

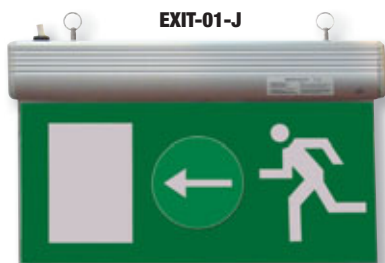

Corpuri de iluminat cu LED pentru mobilă, protejate, seria TLFLED



TRACON							
TLFLED20NW	20 W	28 W	1440 lm	4.000	900×53×65	–	A
TLFLED8NW	8 W	10 W	650 lm	4.000	492×59×66	✓	A
TLFLED15NW	15 W	21 W	1080 lm	4.000	682×59×66	✓	A

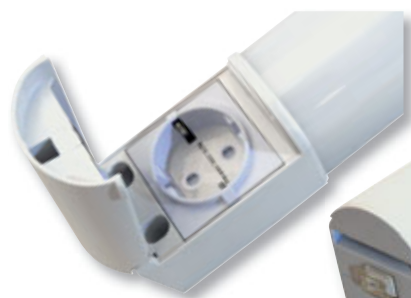

2 YEARS
WARRANTY



IP 44



Corpuri de iluminat cu LED pentru mobilă, seria TLLED



TRACON							
TLLED10W	10 W	18 W	700 lm	4.500 K	605×30×43	120°	A+
TLLED20W	20 W	30 W	1.400 lm	4.500 K	1225×30×43	120°	A+
TLLED24W	24 W	36 W	2.000 lm	4.500 K	1525×30×43	120°	A+

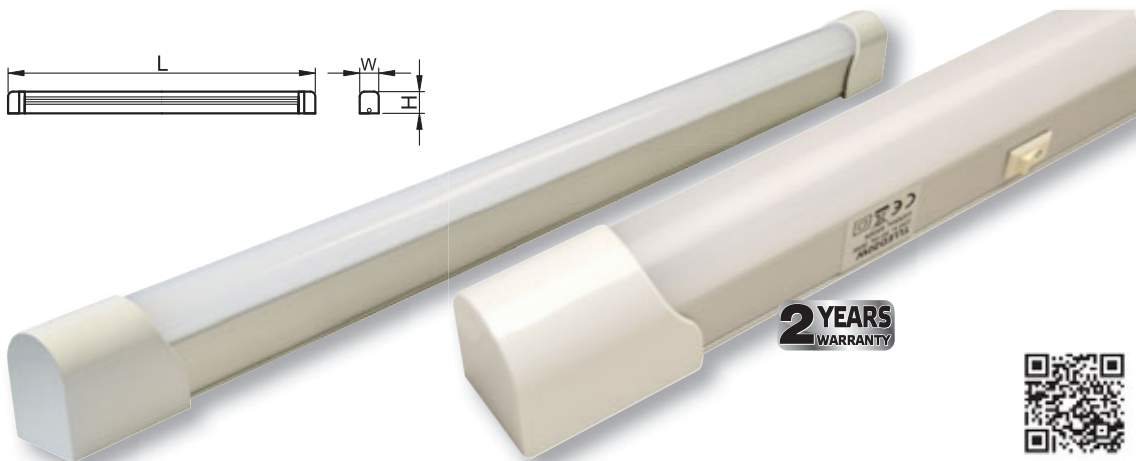

2 YEARS
WARRANTY



Corpuri de iluminat cu LED pentru mobilă, cu carcasă din material plastic

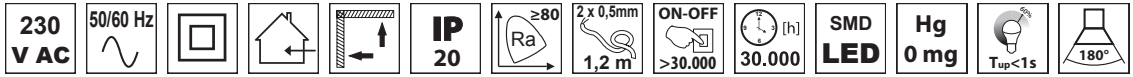

TRACON					L x W x H (mm)	xSMD2835	
LBV5WW	5 W	7 W	400 lm	3.000 K	300x22x35	26	A
LBV5NW	5 W	7 W	400 lm	4.500 K	300x22x35	26	A
LBV10WW	10 W	14 W	800 lm	3.000 K	600x22x35	52	A
LBV10NW	10 W	14 W	800 lm	4.500 K	600x22x35	52	A
LBV15WW	15 W	21 W	1.200 lm	3.000 K	900x22x35	76	A
LBV15NW	15 W	21 W	1.200 lm	4.500 K	900x22x35	76	A
LBV20WW	20 W	28 W	1.600 lm	3.000 K	1200x22x35	100	A
LBV20NW	20 W	28 W	1.600 lm	4.500 K	1200x22x35	100	A

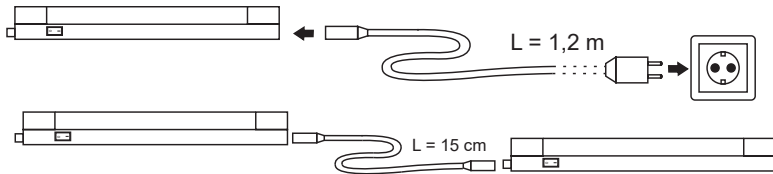
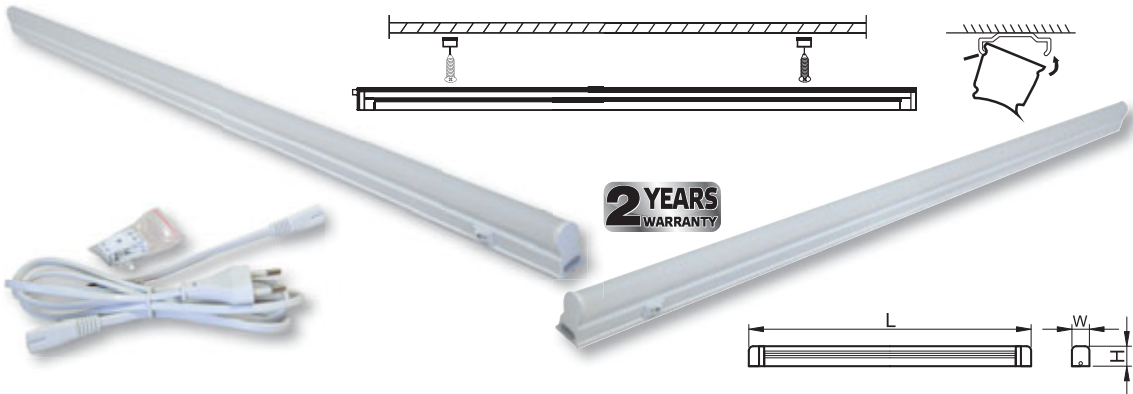

Σ max. 2300 W !



Lămpi cu tub fluorescent

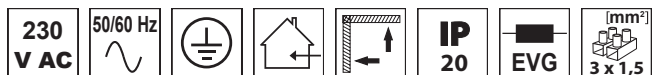

TRACON					L (mm)	W (mm)	H (mm)	
TLL-10	G13	10 W	T8	6.400 K	412	34	64	A
TLL-15	G13	15 W	T8	6.400 K	516	34	64	A
TLL-18	G13	18 W	T8	6.400 K	669	34	64	A
TLL-30	G13	30 W	T8	6.400 K	973	34	64	A
TLL-36	G13	36 W	T8	6.400 K	1270	34	64	A

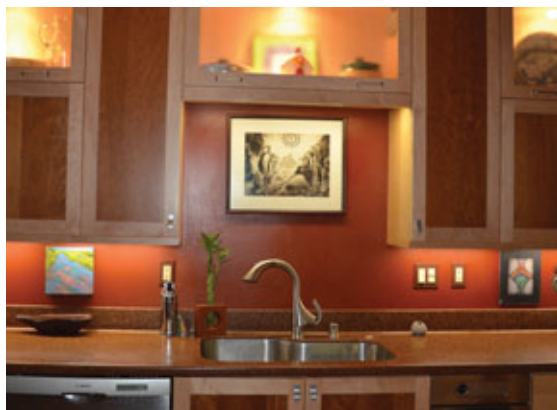

Tuburile fluorescente sunt incluse în corpul de iluminat.

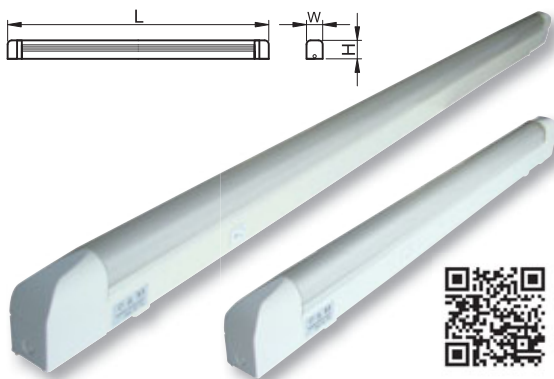





Corp de iluminat cu LED, pentru oglindă



TRACON					L x W x H (mm)	
BL0408NW	8 W	10 W	500 lm	4.000 K	400x121x42	A
BL0612NW	12 W	18 W	860 lm	4.000 K	600x121x42	A
BL0915NW	15 W	21 W	1.080 lm	4.000 K	900x121x42	A





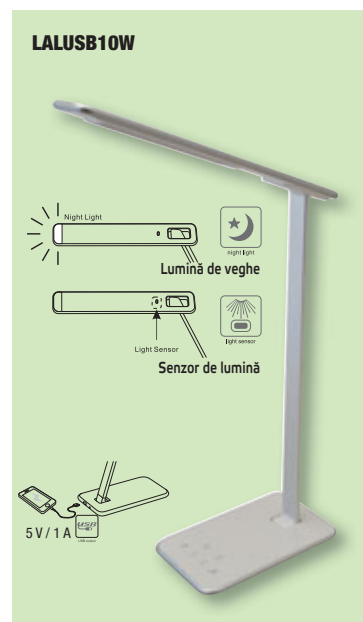
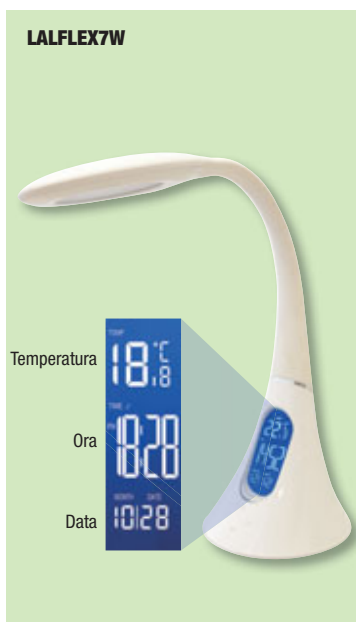
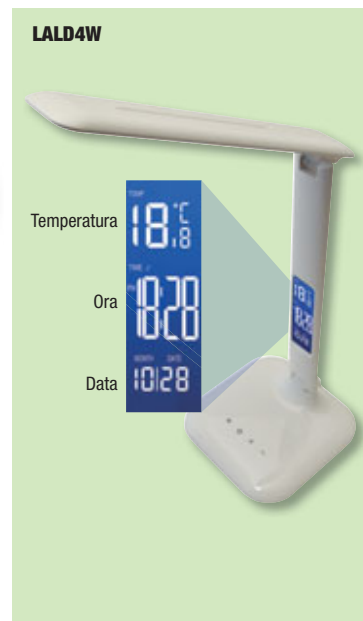

Lămpi de birou cu LED

TRACON	 (W)	 (lm)	 Tc [K]	
LAL4W	4 W	280 lm	2700-6000 K	20-40-60-80-100 %
LALD4W	4 W	280 lm	2700-6000 K	20-40-60-80-100 %
LALFLEX7W	7 W	490 lm	2700-6000 K	20-40-60-80-100 %
LALG3W	3 W	200 lm	4000 K+RGB	30-60-100 %
LALB4W	4 W	280 lm	2700-6000 K	20-40-60-80-100 %
LALUSB10W	10 W	700 lm	2700-6000 K	20-40-60-80-100 %



Lămpi de birou cu LED

TRACON	 [W]	 [lm]	 Tc [K]	
LALUSBM10W	10 W	700 lm	2700-6000 K	20-40-60-80-100 %
LALWCH10W	10 W	700 lm	2700-6000 K	20-40-60-80-100 %
LALSLIM4W	4 W	330 lm	4000 K	20-40-60-80-100 %
LALBFLEX6W	6 W	700 lm	4000K+RGB	33-66-100 %
LALCM8W	8 W	150 lm	6000 K	20-40-60-80-100 %

LALUSBM10W



LALSLIM4W



LALWCH10W

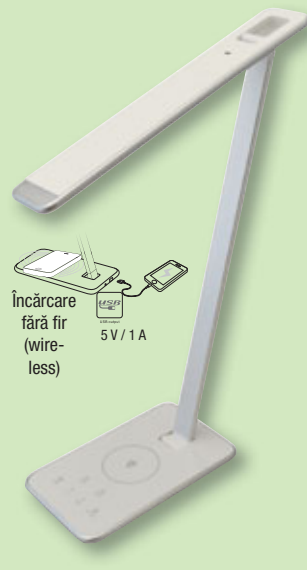

LALBFLEX6W



LALCM8W



Corpuri de iluminat cu LED, de perete, seria LFK



TRACON						
LFK30W	30 W	150 W	2.100 lm	4.500 K	308x288x182	A
LFK40W	40 W	200 W	3.500 lm	4.500 K	308x288x182	A



2 YEARS WARRANTY

**RELEVANT STANDARD
EN 60598**



IP 65

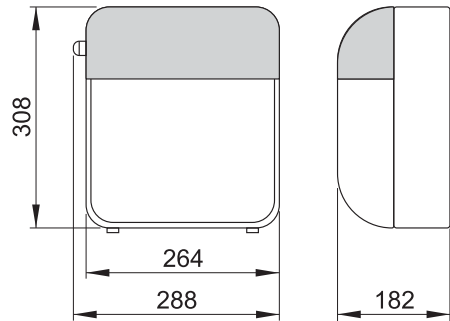

Corpuri de iluminat cu LED, de perete, seria LFB



TRACON						
LFB40NW	40 W	200 W	3.000 lm	4.000 K	276x86	A
LFB60NW	60 W	300 W	4.200 lm	4.000 K	320x89	A



IP 65

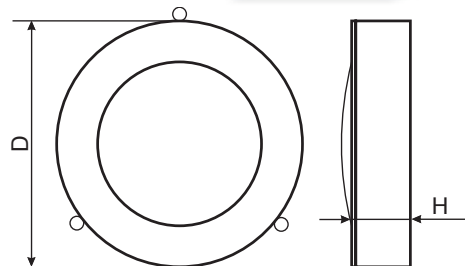

2 YEARS WARRANTY

Corpuri de iluminat încastrate pentru iluminarea scărilor, seria LVS

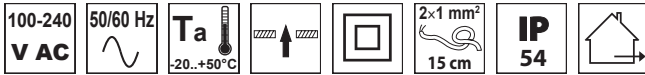

TRACON				Tc [K]	L x W x H (mm)	
LVS01	1,5 W	100 lm		3.500 K	110x44x45	A
LVS02	1,5 W	100 lm		3.500 K	110x44x45	A

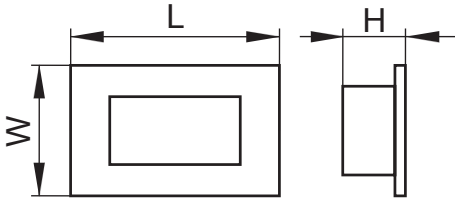

2 YEARS
WARRANTY



RELEVANT STANDARD
EN 60598



Corpuri de iluminat LED încastrate în pavaj



TRACON				Tc [K]	D x L (mm)	
LGL3W	3 W	210 lm		4.500 K	100x100	A
LGL7W	7 W	490 lm		4.500 K	160x110	A
LGL12W	12 W	840 lm		4.500 K	210x115	A
LGL18W	18 W	1260 lm		4.500 K	260x125	A

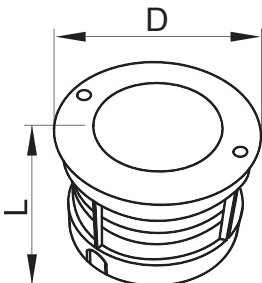

2 YEARS
WARRANTY

Corpuri de iluminat LED de perete, pentru exterior

100-240 V AC 50/60 Hz 30.000 [h] ON-OFF >30.000 Ta -20...+50°C SMD LED Ra ≥70 IP 54

TRACON					L x W x H (mm)	
GARU7W	7 W	50 W	290 lm	4.000 K	232x165x192	A
GARD7W	7 W	50 W	290 lm	4.000 K	232x165x192	A
GARH7W	7 W	50 W	290lm	4.000 K	165x165x810	A

2 YEARS WARRANTY

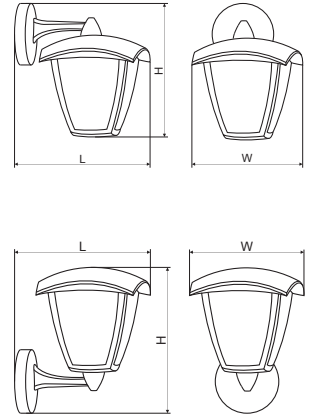

Corpuri de iluminat LED, cu picior, de exterior

100-240 V AC 50/60 Hz 30.000 [h] ON-OFF >30.000 Ta -20...+50°C SMD LED Ra ≥70 IP 54

TRACON					L x W x H (mm)	
GARST7W	7 W	50 W	290 lm	4.000 K	165x1100	A
GARP7W	7 W	50 W	290 lm	4.000 K	165x280	A



2 YEARS WARRANTY

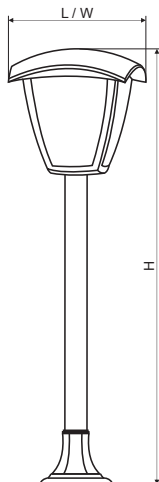

IP 54

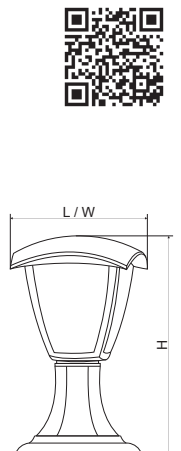

Corpuri de iluminat LED, de perete, pentru exterior, seria GARC

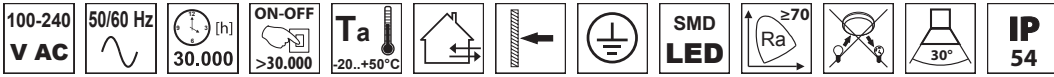

TRACON						L x W x H (mm)	
GARCA6W	6 W	45 W	360 lm	4.000 K	30°	157x106x130	A
GARCB12W	12 W	75 W	680 lm	4.000 K	30°	238x106x130	A

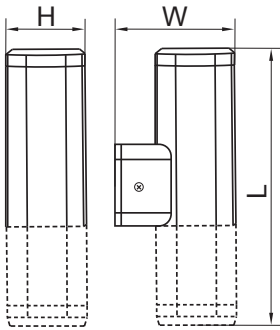

GARCA12W



GARCA6W

Corp de iluminat LED, de perete, pentru exterior, seria GLOO



TRACON						L x W x H (mm)	
GLOO8NW	8 W	60 W	650 lm	4.000 K	120°	140x170x59	A+

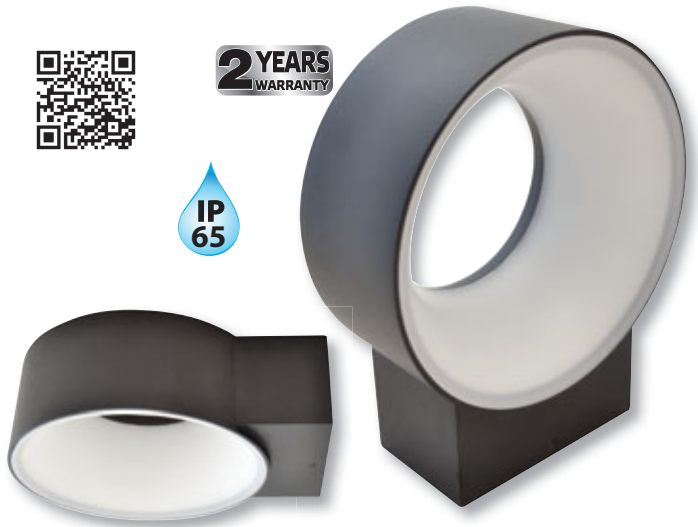
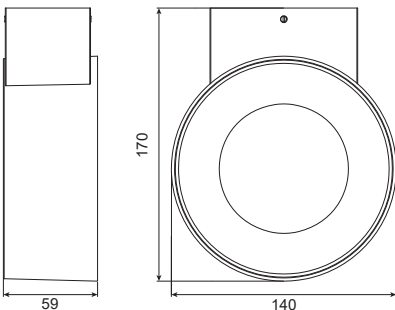

Detectoare infraroșii de mișcare

230
V AC

50/60 Hz

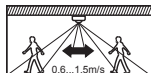
**Legendă
pictograme** **E1/0**

TRACON	[°]	lux		IP..	L x W x H (mm)
TMB-108	180°	3-2000 lux	10 s ... 7 min.	IP 44	82x104x72
TMB-112	180°	3-2000 lux	10 s ... 12 min.	IP 44	91x84x63
TMB-112F	180°	3-2000 lux	10 s ... 12 min.	IP 44	91x84x63
TMB-115	180°	3-2000 lux	10 s ... 15 min.	IP 65	80x117x51
TMB-118	360°	3-2000 lux	10 s ... 15 min.	IP 44	119x60x79
TMB-016	180°	3-2000 lux	10 s ... 7 min.	IP 44	120x78x28
TMB-060	160°	3-2000 lux	10 s ... 7 min.	IP 20	80x80x34
TMB-061	360°	3-2000 lux	10 s ... 15 min.	IP 20	∅ 76x76
TMB-061M	360°	3-2000 lux	10 s ... 15 min.	IP 20	∅ 50x67
TMB-E50	360°	3-2000 lux	10 s ... 5 min.	IP 20	∅ 64,5x127
TMB-DA	120°	3-2000 lux	10 s ... 7 min.	IP 20	98x81x45
TMB-011	360°	3-2000 lux	10 s ... 15 min.	IP 20	∅ 88x42
TMB-011L	360°	3-2000 lux	10 s ... 15 min.	IP 20	∅ 115x24

Capacitatea de comutație

TRACON	TMB-108	TMB-112	TMB-112F	TMB-115	TMB-118	TMB-016	TMB-060
	1.000 W	1.000 W	1.000 W	1.000 W	1.200 W	1.200 W	1.000 W
 HALOGEN	800 W	800 W	800 W	800 W	800 W	800 W	800 W
 CFL	300 W	300 W	300 W	300 W	300 W	300 W	300 W
 LED	300 W	300 W	300 W	300 W	300 W	300 W	300 W
 h _t	1,8 - 2,5 m	1,8 - 2,5 m	1,8 - 2,5 m	1,8 - 2,5 m	1,8 - 2,5 m	1,8 - 2,5 m	1 - 1,8 m
 L _s	<12 m	<12 m	<12 m	<12 m	<12 m	<12 m	<9 m

Capacitatea de comutație

TRACON	TMB-061	TMB-061M	TMB-E50	TMB-DA	TMB-011	TMB-011L
	1.100 W	800 W	60 W	1.200 W	1.200 W	2.000 W
 HALOGEN	900 W	600 W	60 W	800 W	800 W	1.500 W
 CFL	300 W	400 W	30 W	300 W	300 W	1.000 W
 LED	300 W	400 W	30 W	300 W	300 W	1.000 W
 h _t	2,2 - 4 m	2,2 - 4 m	2 - 3,5 m	1 - 1,8 m	2,2 - 4 m	2,2 - 4 m
 L _s	<6 m	<6 m	<6 m	<2 - 9 m	<6 m	<6 m

Detectoarele de mișcare infraroșii pasive (PIR) sesizează mișcarea căldurii generată de obiecte și în cazul în care deplasarea este suficient de mare releul încorporat în detector cuplează. De aceea detectorul trebuie să „vadă” obiectul în mișcare, fără aceasta detecția și cuplarea nu are loc. Sensibilitatea pentru mișcare transversală este întotdeauna mai mare, pentru mișcarea de apropiere este mai mică, de aceea se recomandă montarea în paralel cu direcția probabilă de mișcare a detectoarelor echipate cu un senzor.

Sensibilitatea detectorilor de mișcare în infraroșu nu poate fi reglată!



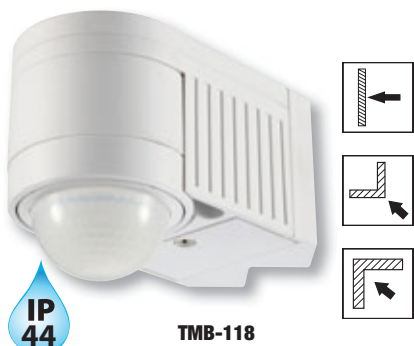



Detectoare de mișcare tip radar







230
V AC

50/60 Hz



TRACON	 [°]	 lux		IP..	L x W x H (mm)
TMB-L01G	360°	3-2000 lux	10 s ... 12 min.	IP 20	81x42x44
TMB-L01D	360°	3-2000 lux	10 s ... 12 min.	IP 20	58x41x26
TMB-L01M	360°	3-2000 lux	10 s ... 12 min.	IP 20	56x40x23
TMB-L01DIMM	360°	3-2000 lux	5 s ... 30 min.	IP 20	78x45x26
TMB-152R	180°	3-2000 lux	10 s ... 12 min.	IP 44	86x60x79
TMB-054R	180°	3-2000 lux	10 s ... 12 min.	IP 20	80x80x32
TMB-061R	360°	3-2000 lux	10 s ... 12 min.	IP 20	∅ 76x76
TMB-ME51	360°	3-2000 lux	10 s ... 12 min.	IP 20	71x50x82

Capacitatea de comutație

TRACON	TMB-L01G	TMB-L01D	TMB-L01M	TMB-L01DIMM	TMB-152R	TMB-054R	TMB-061R	TMB-ME51
	1.200 W	500 W	1.200 W	600 W	1.200 W	1.200 W	1.200 W	60 W
 HALOGEN	1.000 W	400 W	800 W	300 W	800 W	800 W	800 W	60 W
 CFL	300 W	200 W	300 W	200 W	300 W	300 W	300 W	30 W
 LED	300 W	200 W	300 W	200 W	300 W	300 W	300 W	30 W
 h _t	1,5 - 8 m	1,5 - 8 m	1,5 - 8 m	1,5 - 8 m	1,5 - 3,5 m	1,5 - 1,8 m	1,5 - 3,5 m	2 - 4 m
 L _s	1 - 8 m	1 - 8 m	1 - 8 m	1 - 8 m	5 - 15 m	1 - 15 m	1 - 8 m	1 - 5 m

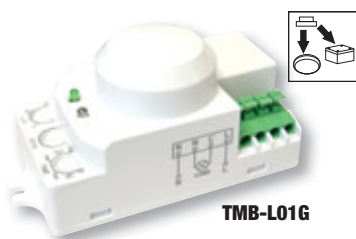

Detectoarele de mișcare care utilizează tehnologia radar sesizează reflexia semnalului radar emis de acestea și în cazul în care semnalul reflectat se modifică față de semnalul emis datorită mișcării unui obiect sau a unei vietăți atunci releul de ieșire cuplează. Avantajul tehnologiei este că „vede” și prin obiecte subțiri, nemetalice (de exemplu: sticlă, material plastic, ghips-carton), astfel detectoarele se pot monta și mascat în corpul de iluminat, cutii din material plastic respectiv în spatele geamului din sticlă. De aceea sensibilitatea trebuie reglată foarte precis!

Senzor de prezență

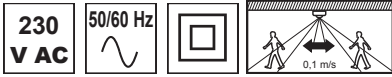

TRACON	$[\text{°}]$	lux		IP..	L x W x H (mm)
PRS46B	360°	3-2000 lux	10 s...30 min.	IP 20	102x102x58

Capacitatea de comutație

TRACON	PRS46B
	1.200 W
HALOGEN	1.000 W
CFL	300 W
LED	300 W
t _h	2,2 - 6 m
L _s	< 20 m

Detectează și cele mai mici mișcări ale corpului. Prin urmare se recomandă pentru comanda iluminatului în acele încăperi unde persoanele au activități statice o perioadă mai lungă de timp (Toaletă, birou).

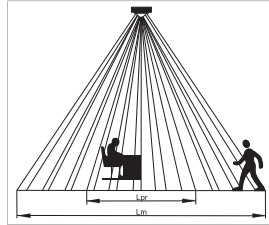

Senzori crepusculari

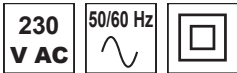

TRACON	I _n	lux	ON - t _{off}	IP..	L x W x H (mm)
ALK-OUT	10 A	5-50 lux	-	IP 44	∅ 82x108
ALK-BOX	16 A	2-100 lux	-	IP 20	90x35x66
ALK-IN	5 A	2-100 lux	1-8 h, OFF	IP 44	109x70x40
ALK-472	1 A (100 W)	5-15 lux	1-12 h, OFF	IP 20	∅ 52x89
ALK110	-	50-800 lux, 1-10 VDC	-	IP 20	∅ 21x64

Capacitatea de comutație

TRACON	ALK-OUT	ALK-BOX	ALK-IN	ALK-472
	300 W	500 W	900 W	100 W
HALOGEN	200 W	300 W	500 W	100 W
CFL	100 W	120 W	200 W	50 W
LED	100 W	120 W	200 W	50 W

Caracteristica tuturor senzorilor crepusculari este că la prima alimentare cu tensiune efectuează un autotest care constă într-o cuplare și o decuplare. Funcționarea normală începe după un timp de întârziere de 15 s-1 min după efectuarea autotestului.



ALK-BOX



ALK-IN



ALK-OUT



ALK-472



ALK110



Alimentatoare LED cu carcasă metalică, protejate, tip ELG



TRACON		U_{sec} 	I_{pr} 	I_{sec} 	$\eta\%$	L x W x H (mm)
ELG-150-12APL	150 W	12 VDC	0,9 A	10 A	88 %	219x63x35,5
ELG-150-24A-3Y	150 W	24 VDC	0,9 A	6,25 A	89 %	219x63x35,5
ELG-200-12A-3Y	200 W	12 VDC	1,2 A	16 A	90 %	244x71x37,5
ELG-200-24A-3Y	200 W	24 VDC	1,2 A	8,4 A	92 %	244x71x37,5

5 YEARS WARRANTY

IP 65

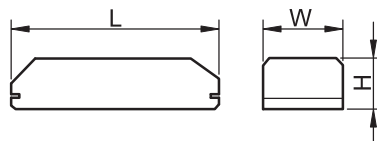

ELG-150..



ELG-200..



Alimentatoare LED cu carcasă metalică, protejate, tip HLG



TRACON		U_{sec} 	I_{pr} 	I_{sec} 	$\eta\%$	L x W x H (mm)
HLG-150H-12A	150 W	10,8-13,5 VDC	0,75 A	7,5-12,5 A	91,5 %	228x68x38,8
HLG-240H-12A	240 W	11,2-12,8 VDC	2 A	8-16 A	90 %	251x68x38,8
HLG-240H-24A	240 W	22,4-25,6 VDC	2 A	5-10 A	92,5 %	251x68x38,8
HLG-320H-12A	320 W	10,8-13,5 VDC	1,65 A	11-22 A	91 %	252x90x43,8
HLG-320H-24A	320 W	21-26 VDC	1,65 A	6,7-13,3 A	94,5 %	252x90x43,8

7 YEARS WARRANTY

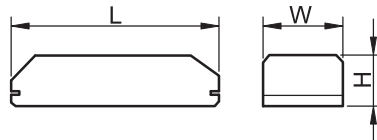

HLG-150H..

IP 65



HLG-240H..



Alimentatoare pentru priză



TRACON					$\eta\%$	L x W x H (mm)
GST25E12-P1J	25 W	12 VDC	0,35 A	2,08 A	86,5 %	79x54x33
GST36E12-P1J	36 W	12 VDC	0,45 A	3 A	87,5 %	79x54x33
SGA60E12-P1J	60 W	12 VDC	0,75 A	5 A	88 %	93,5x35x51,5

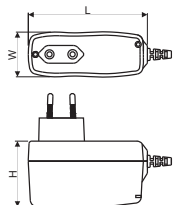

3 YEARS WARRANTY



Alimentatoare cu montaj pe șină

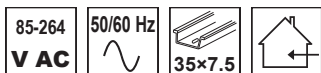

TRACON					$\eta\%$	L x W x H (mm)	
HDR-15-12		15 W	10,8-13,8 VDC	0,25 A	1,25 A	85 %	17,5x90x54,5
HDR-15-24		15 W	21,6-29 VDC	0,25 A	0,63 A	86 %	17,5x90x54,5
HDR-30-12		30 W	10,8-13,8 VDC	0,48 A	2 A	88 %	35x90x54,5
HDR-30-24		30 W	21,6-29 VDC	0,48 A	1,5 A	89 %	35x90x54,5
HDR-60-12		60 W	10,8-13,8 VDC	0,8 A	4,5 A	88 %	52,5x90x54,5
HDR-60-24		60 W	21,6-29 VDC	0,8 A	2,5 A	90 %	52,5x90x54,5
HDR-100-12N		100 W	12-13,8 VDC	1,6 A	7,5 A	88 %	70x90x54,5
HDR-100-24N		100 W	21,6-29 VDC	1,6 A	4,2 A	90 %	70x90x54,5
NDR-120-12		120 W	12-14 VDC	1,3 A	10 A	85,5 %	40x125x113
NDR-120-24		120 W	24-28 VDC	1,3 A	5 A	88 %	40x125x113
NDR-240-24		240 W	24-28 VDC	1,3 A	10 A	88,5 %	63x125x113

3 YEARS WARRANTY

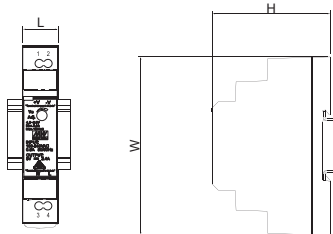

3 YEARS WARRANTY



Alimentator benzi LED, carcasă metalică

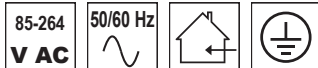

TRACON					$\eta\%$	PFC	L x W x H (mm)
RS-15-12	15 W	10,8-13,2 VDC	0,25 A	1,3 A	81 %	–	62,5x51x28
RS-15-24	15 W	22-27,6 VDC	0,25 A	0,625 A	82 %	–	62,5x51x28
RS-25-12	25 W	10,8-13,2 VDC	0,4 A	2,1 A	81 %	–	78x51x28
RS-25-24	25 W	22-27,6 VDC	0,4 A	1,1 A	86 %	–	78x51x28
LRS-35-12	35 W	10,2-13,8 VDC	0,42 A	3 A	86 %	–	92x88x30
LRS-35-24	35 W	21,6-28,8 VDC	0,42 A	1,5 A	88 %	–	92x88x30
LRS-50-12	50 W	10,2-13,8 VDC	0,56 A	4,2 A	86 %	–	99x82x30
LRS-50-24	50 W	21,6-28,8 VDC	0,56 A	2,2 A	88 %	–	99x82x30
LRS-75-12	75 W	10,2-13,8 VDC	0,85 A	6 A	89 %	–	99x97x30
LRS-75-24	75 W	21,6-28,8 VDC	0,85 A	3,2 A	90 %	–	99x97x30
LRS-100-12	100 W	10,2-13,8 VDC	1,2 A	8,5 A	88 %	–	127x97x30
LRS-100-24	100 W	21,6-28,8 VDC	1,2 A	4,5 A	90 %	–	127x97x30
LRS-150-12	150 W	10,2-13,8 VDC	1,7 A	12,5 A	87 %	–	159x97x30
LRS-150-24	150 W	21,6-28,8 VDC	1,7 A	6,5 A	89 %	–	159x97x30
RSP-200-12	200 W	10-13,2 VDC	1,1 A	16,7 A	85 %	✓	215x115x30
RSP-200-24	200 W	20-26,4 VDC	1,1 A	8,4 A	89 %	✓	215x115x30
RSP-320-12	320 W	10-13,2 VDC	2 A	26,7 A	88 %	✓	215x115x30
RSP-320-24	320 W	20-26,4 VDC	2 A	13,4 A	89 %	✓	215x115x30



RS..



LRS..

3 YEARS
WARRANTY

RSP..

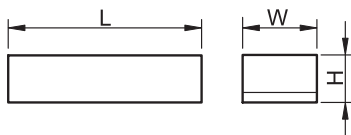





Benzi cu LED-uri



E2/14

Alimentatoare LED cu carcasă din material plastic, cu grad de protecție



TRACON						$\eta\%$	L x W x H (mm)
LPH-18-12	18 W	180-264 VAC	12 VDC	0,3 A	1,5 A	77 %	140x30x22
LPH-18-24	18 W	180-264 VAC	24 VDC	0,3 A	0,75 A	77 %	140x30x22
LPV-20-12	20 W	90-264 VAC	12 VDC	0,35 A	1,67 A	81 %	118x35x26
LPV-20-24	20 W	90-264 VAC	24 VDC	0,35 A	0,84 A	83 %	118x35x26
LPV-35-12	36 W	90-264 VAC	12 VDC	0,7 A	3 A	84 %	148x40x30
LPV-35-24	36 W	90-264 VAC	24 VDC	0,7 A	1,5 A	85 %	148x40x30
LPV-60-12	60 W	90-264 VAC	12 VDC	1 A	5 A	83 %	163x43x32
LPV-60-24	60 W	90-264 VAC	24 VDC	1 A	2,5 A	86 %	163x43x32
LPV-100-12	100 W	90-264 VAC	12 VDC	1,5 A	8,5 A	85 %	190x52x37
LPV-100-24	100 W	90-264 VAC	24 VDC	1,5 A	4,2 A	88 %	190x52x37
LPV-150-12	120 W	180-305 VAC	12 VDC	1,7 A	10 A	87 %	191x63x38
LPV-150-24	150 W	180-305 VAC	24 VDC	1,7 A	6,3 A	89 %	191x63x38



LPH-18-12

2 YEARS
WARRANTY

LPV-20..

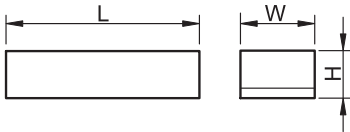

LPV-150..

CONTACT SIGUR ÎN ORICE SITUAȚIE

Montare pe cablu și montare pe perete

Variantă constructivă cu
preschimbare a fazei

Cu posibilitatea de blocare



TRACON
ELECTRIC®

G/16



Module de comandă a fluxului luminos care pot fi montate în doza de aparataj

Cu ajutorul acestor module, comanda poate fi realizată în mod simplu cu ajutorul unui buton în cazul surselor de lumină, a corpurilor de iluminat și a benzilor cu LED la care poate fi reglat fluxul luminos. Modulele pot fi amplasate în spatele butonului în doza de aparataj. Pornirea și oprirea se poate realiza prin apăsarea scurtă a butonului, comanda poate fi realizată prin apăsarea continuă a butonului. Prin conectarea în paralel a butoanelor comanda iluminării coridoarelor și modificarea fluxului luminos poate fi realizată din mai multe locuri! La utilizarea butoanelor iluminate, curenții de scurgere nedorii pot fi eliminați prin utilizarea compensatorului ACDM003. Modulul de comandă recomandat pentru benzile LED poate fi utilizat exclusiv la cele monocrome cu tensiunea de 12-48 Vc.c. Cu ajutorul amplificatorului de semnal lungimea benzilor LED care pot fi comandate într-un grup poate fi mărită.

TRACON			Numărul butoanelor	Ta ↓	L x W x H (mm)
REPLELE0	200 W	Triac LED	∞ (neiluminate)	0 °C ... +40 °C	45x45x12
REPLELE1	350 W	Triac LED	∞ (3 buc iluminate)	0 °C ... +40 °C	45x45x12
REPLALE2	8 A	Bandă LED monocromă	∞ (neiluminate)	0 °C ... +40 °C	46x46x24
AMPLALE2	8 A	Bandă LED monocromă	-	0 °C ... +40 °C	45x42x12



REPLELE0



REPLELE1



REPLALE2



AMPLALE2

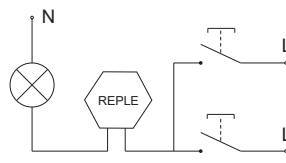
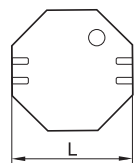

Unități de comandă fără fir pentru circuite de iluminat

Sistemul este alcătuit dintr-un receptor și una sau mai multe emițătoare. Emițătorul poate fi montat în spatele unui detector de mișcare sau a unui buton. Semnalul emițătorului pe frecvența radio (868,4 MHz) ajunge la receptor care controlează corpul (corpurile) de iluminat în mod temporizator sau ca releu.

TRACON		Natura unității de comandă	Caracteristici	Ta ↓	L x W x H (mm)
DMSENR01	-	Detector de mișcare (cu baterie)	3-100 lx, 360°	-10 °C ... +40 °C	80x80x45
DMSENR03	-	Detector de mișcare (cu baterie)	3-100 lx, 180°	-10 °C ... +40 °C	82x104x72
EMMIN001	-	Modul emițător	-	0 °C ... +55 °C	55x53x34
MIPLAR01	400 W	Unitatea de recepție	30 s - 10 min	0 °C ... +40 °C	45x40x13



DMSENR01



DMSENR03



EMMIN001



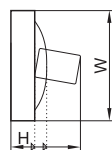
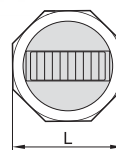

MIPLAR01



Module de comandă a fluxului luminos care pot fi montate pe șină DIN

Aceste module sunt concepute pentru a fi montate într-o cutie de distribuție. Controlul acestora se realizează, de asemenea prin butoane. Dimensiunile fizice mai mari reprezintă și o capacitate de încărcare mai mare.

TRACON			Numărul butoanelor	T _a 	L x W x H (mm)
REEL1LE1	350 W	Triac LED	∞ (3 buc iluminate)	0 °C ... +40 °C	90×60×17,5
REEL5LE3	1000 W	Triac / 0-10 V LED	∞ (neiluminate)	0 °C ... +40 °C	90×61×87,5
REEL2LE2	20 A	Bandă LED monocromă	∞ (neiluminate)	0 °C ... +55 °C	90×65×35
REEL5002	16 A	0-10 V LED (max. 250 mA)	∞ (neiluminate)	0 °C ... +40 °C	90×61×87,5



REEL1LE1



REEL5LE3



REEL2LE2



REEL5002

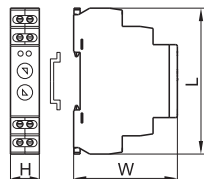
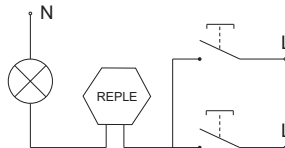

Compensator

La utilizarea butoanelor iluminate, curenții de scurgere nedoriti pot fi eliminați prin utilizarea compensatorului ACDM003.

TRACON

ACDM003

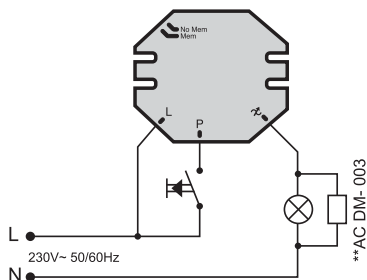

Treceți și Dumneavoastră pe LED!