

**TYTAN T4**

Montageanweisung  
 Assembly instructions  
 Instructions de montage

Lebensgefahr  
 Danger  
 Danger de mort



Montage nur durch Elektrofachkräfte  
 Installation by electricians only  
 Montage uniquement par un électricien

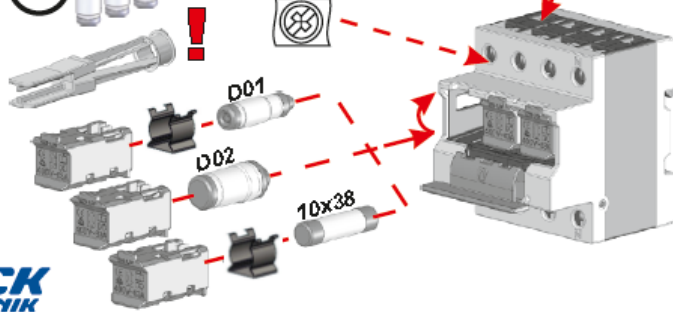
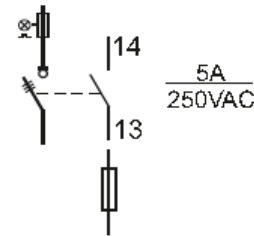
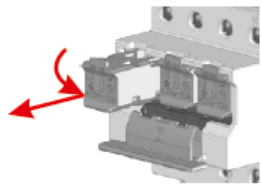
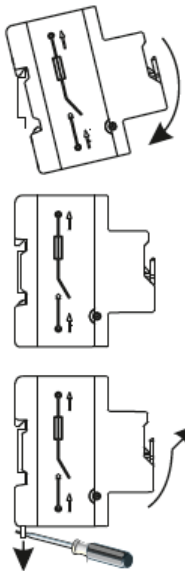

L1 - L2 - L3

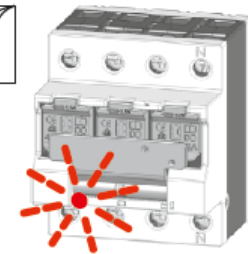
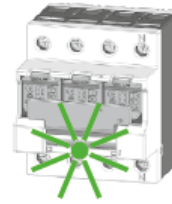

L?

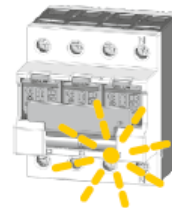
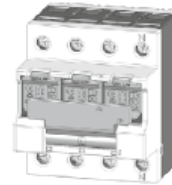

ma\_TYTAN\_T\_04\_112014

Schrack Technik GmbH  
 Seybelgasse 13  
 A - 1230 VIENNA

Tel +43 1/866 85-0  
 E-MAIL info@schrack.com  
 INTERNET www.schrack.com

1. I ↓ O

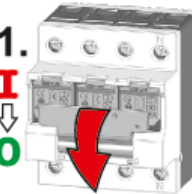

2. I ↓ O

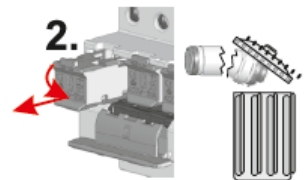

3. I ↓ O

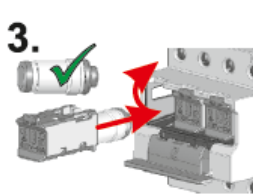

4. I ↑ O

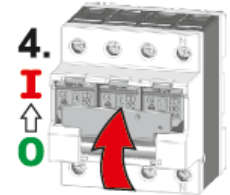

WWW.SCHRACK.COM