

INSTALLATION MANUAL

63056

ecolight



80
CRI

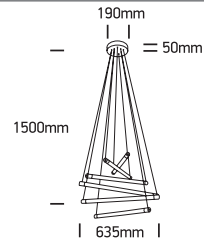

230V | SMD 2835 | 50W | IP20 | Steel + aluminium + acrylic

Complete with 24V DC driver.

one
LIGHT

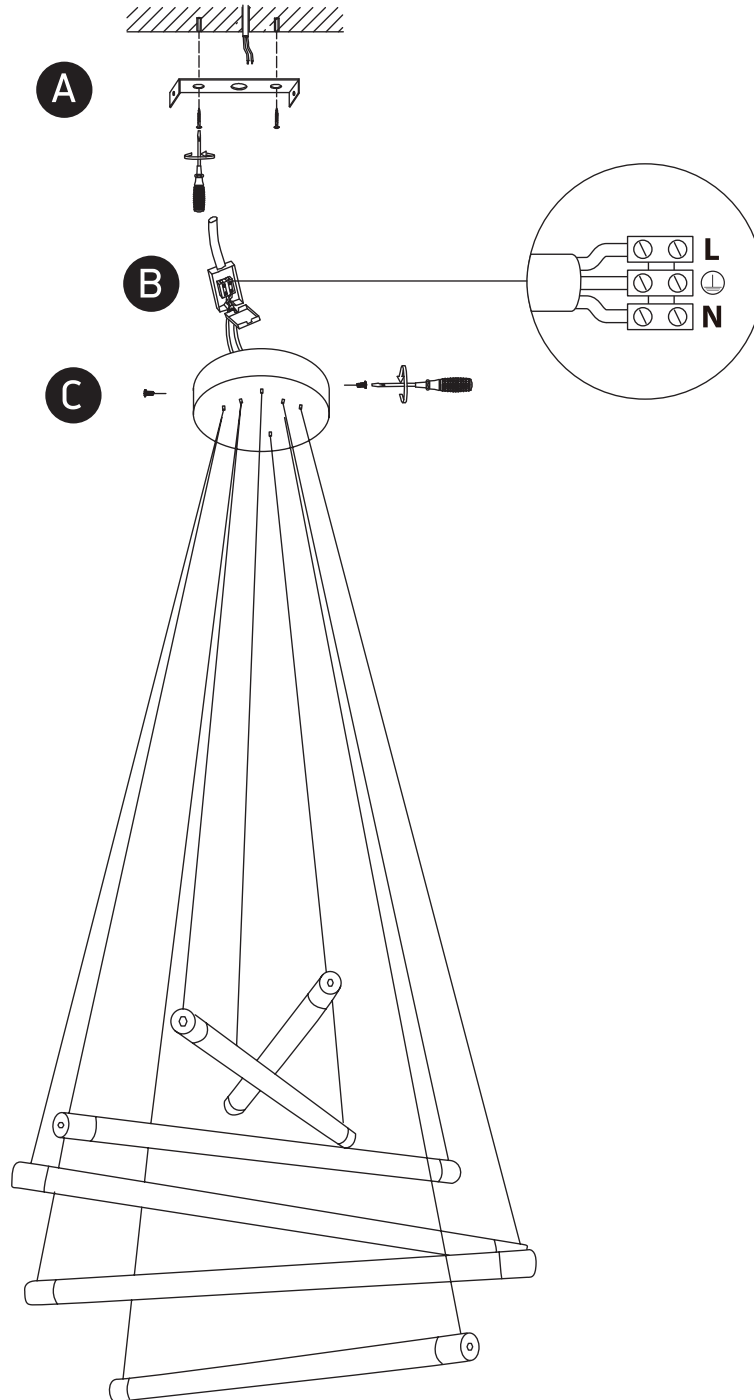

Warnings:

1. Fix the base on the ceiling.
2. Make sure that the product is installed properly before connecting to electricity.
3. Connect the AC power cable to the driver's cable as shown in the above diagram.
4. Do not cover the fitting.
5. Maintenance and installation should only be carried out by a professional electrician.