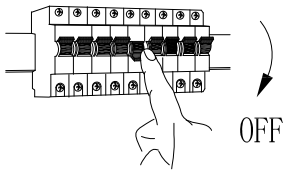
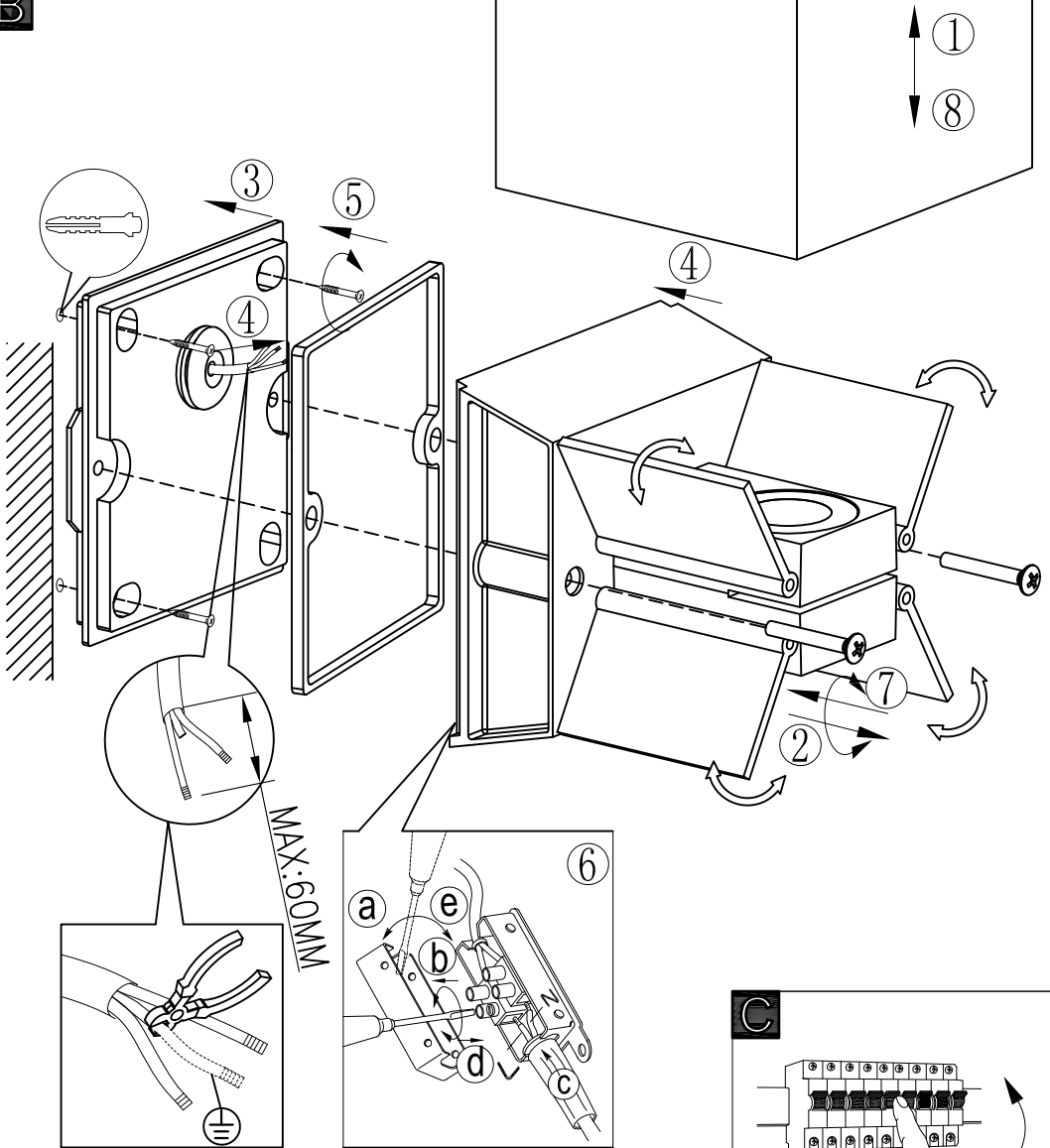
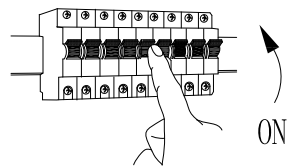

**A****B****C**

BLA61921  
 WWW.EGLO.COM